

PRODUCT SPECIFICATION

		No. T-1-1283 (R-1-1283)	Date Issued: October 13, 1995
Customer:	GENERAL	Revised: H	Date Revised: March 19, 2015
Title Subject:	XM Connector (For wire-to-wire)		Issued by: Osaka Engineering Center

This product specification contains the results of performance tests for the XM Connector (For wire-to-wire).

-Index-

1. PART NAME, PART NUMBER & DRAWING NUMBER
2. CONSTRUCTION, DIMENSIONS, MATERIAL & SURFACE FINISH
3. CHARACTERISTICS
4. SPECIMEN
5. TEST CONDITIONS
6. REQUIREMENTS, TEST METHODS & TEST RESULTS
 - 6.1 Appearance
 - 6.2 Mechanical Performance Test
 - 6.2.1 Insertion Force (I.F.) & Withdrawal Force (W.F.)
 - 6.2.2 Crimp Tensile Strength
 - 6.2.3 Contact Insertion Force
 - 6.2.4 Contact Retention Force
 - 6.2.5 Locking Strength
 - 6.2.6 Panel Lock Strength (Apply for the only product with panel lock)
 - 6.3 Electrical Performance Test
 - 6.3.1 Contact Resistance
 - 6.3.2 Current Continuity
 - 6.3.3 Insulation Resistance
 - 6.3.4 Dielectric Withstanding Voltage
 - 6.4 Environmental Test
 - 6.4.1 Durability
 - 6.4.2 Humidity
 - 6.4.3 Heat Aging
 - 6.4.4 Thermal Shock
 - 6.4.5 Hydrogen Sulfide Gas
 - 6.4.6 Salt Spray
 - 6.4.7 Vibration
 - 6.4.8 Ammonia Gas



This is our exclusive property. It is not to be copied, reprinted or disclosed to a third party, not used for manufacturing, without our written consent.

Prepared by: <u>M. Veda</u>	Checked by: <u>K. Matsumoto</u>	Reviewed by: <u>T. Ogura</u>	Approved by: <u>H. Tomimoto</u>
--------------------------------	------------------------------------	---------------------------------	------------------------------------

This is our exclusive property. It is not to be copied, reprinted or disclosed to a third party, not used for manufacturing, without our written consent, and has to be returned to us.

Title Subject: XM Connector (For wire-to-wire)	No. T-1-1283 (R-1-1283)	Revised: H
--	----------------------------	------------

1. PART NAME, PART NUMBER & DRAWING NUMBER

Part Name		Part Number	Drawing Number
Pin contact		SXM-001T-P0.6	KRD-15763-2
Socket contact		SXA-001T-P0.6	KRD-15762-1
Receptacle housing	With panel lock	XMR-*V	KRD-15766-2
		XMR-18V	KRD-15976
Without panel lock		XMR-*VF	KRD-16127-1
Plug housing		XMP-*V	KRD-15764-2
		XMP-18V	KRD-15975
Retainer		XMS-*V	KRD-15767-1

Note₁: Number of circuits in one or two-digit figure is indicated in *.

2. CONSTRUCTION, DIMENSIONS, MATERIAL & SURFACE FINISH

Construction and dimensions shall be in accordance with the referenced drawings. Material and surface finish shall be as specified below.

Part Name	Material	Surface Finish etc.
Pin contact	Phosphor bronze	Tin-plated
Socket contact	Phosphor bronze	Tin-plated
Receptacle housing	PA 66	Color: Natural Flammability: UL94V-0
Plug housing	PA 66	Color: Natural Flammability: UL94V-0
Retainer	PA 66 (Glass-filled)	Color: Natural Flammability: UL94V-0

3. CHARACTERISTICS

Item		Rated Value
Current rating		3 A (AC, DC) (Note ₂)
Voltage rating		250 V (AC, DC)
Temperature range		-25 to + 85 °C (Note ₃)
Applicable wire	Conductor size	AWG #28 to #22 (Note ₄)
	Insulation O.D.	φ0.8 to φ1.9 mm
Applicable panel	Thickness	0.5 to 1.8 mm
	Hole size	See the attached drawing (KRD-16073-1).

Note₂: When AWG #22 applied.

Note₃: Including temperature rise in applying an electrical current.

Note₄: Wire conductor shall be tin-plated annealed copper wire (stranded wire).

Title Subject: XM Connector (For wire-to-wire)	No. T-1-1283 (R-1-1283)	Revised: H
--	----------------------------	------------

4. SPECIMEN

Part Name		Part Number	
Contact	Pin	SXM-001T-P0.6	
	Socket	SXA-001T-P0.6	
Housing	Receptacle	With panel lock	XMR-*V
		Without panel lock	XMR-*VF
	Plug	XMP-*V	

Note₅: Number of circuits in one or two-digit figure is indicated in *.

5. TEST CONDITIONS

- 1) When tested in accordance with the test conditions and method specified in each item, each requirement shall be met.
- 2) Unless otherwise specified, tests shall be conducted under the following ambient conditions specified in JIS C 60068-1 (IEC 60068-1) [Basic Environmental Testing Procedures General and Guidance].

Temperature: 15 to 35 °C
Relative humidity: 25 to 75 %

- 3) For environmental tests, as a rule, the specimen assembled for actual use and wire of UL1007 style AWG #22 shall be used.

6. REQUIREMENTS, TEST METHODS & TEST RESULTS**6.1 Appearance**

Requirement: There shall be no crack, deformation or discoloration which may affect the performances specified in this specification.

Test method: Visual inspection.

Test result: Good.

This is our exclusive property. It is not to be copied, reprinted or disclosed to a third party, not used for manufacturing, without our written consent, and has to be returned to us.

Title Subject: XM Connector (For wire-to-wire)	No. T-1-1283 (R-1-1283)	Revised: H
--	----------------------------	------------

6.2 Mechanical Performance Test

6.2.1 Insertion Force (I.F.) & Withdrawal Force (W.F.)

Requirement:

No. of circuits	At Initial		At 30th
	I.F. (N max.)	W.F. (N min.)	W.F. (N min.)
2	20	1.0	0.8
3	25	1.5	1.0
4	30	2.0	1.2
5	35	2.5	1.5
6	40	3.0	2.0
7	45	3.5	2.5
8	50	4.0	3.0
9	55	4.5	3.5
10	60	5.0	4.0
11	65	5.5	4.5
12	70	6.0	5.0
18	85	7.5	6.5

UNIT: N

Test method: A receptacle housing with pin contacts and a plug housing with socket contacts shall be mated and unmated on the mating axis. Initial insertion and withdrawal forces and also withdrawal force at 30th shall be measured. (Testing speed: 1 to 5 mm/sec.)

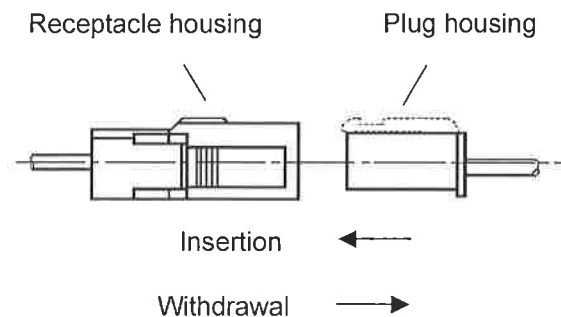

Housing lock shall be removed before the test.

This is our exclusive property. It is not to be copied, reprinted or disclosed to a third party, not used for manufacturing, without our written consent, and has to be returned to us.

Title Subject: XM Connector (For wire-to-wire)	No. T-1-1283 (R-1-1283)	Revised: H
--	----------------------------	------------

Test result:

UNIT: N

No. of circuits	Items	Ave.	Max.	Min.
2	Initial I.F.	5.0	5.7	3.8
	Initial W.F.	2.9	3.5	2.4
	W.F. at 30th	1.8	2.2	1.6
3	Initial I.F.	5.4	5.7	4.5
	Initial W.F.	3.8	4.1	3.4
	W.F. at 30th	2.2	2.7	1.6
4	Initial I.F.	5.6	6.1	5.2
	Initial W.F.	4.3	4.7	4.0
	W.F. at 30th	3.3	3.8	3.1
5	Initial I.F.	6.4	6.8	6.1
	Initial W.F.	5.7	6.0	5.3
	W.F. at 30th	4.6	4.8	4.4
6	Initial I.F.	7.6	8.3	7.0
	Initial W.F.	6.7	7.1	6.2
	W.F. at 30th	5.3	5.8	4.8
7	Initial I.F.	9.3	9.7	8.5
	Initial W.F.	8.2	8.7	7.6
	W.F. at 30th	6.1	6.6	5.7
8	Initial I.F.	11.0	11.8	10.2
	Initial W.F.	9.7	10.3	9.2
	W.F. at 30th	6.8	7.8	6.0
9	Initial I.F.	13.4	15.0	12.2
	Initial W.F.	11.3	13.9	10.3
	W.F. at 30th	7.8	9.9	6.2
10	Initial I.F.	14.6	16.3	13.1
	Initial W.F.	10.6	11.3	10.1
	W.F. at 30th	8.7	9.7	7.8
11	Initial I.F.	16.5	17.5	15.3
	Initial W.F.	11.6	12.6	10.4
	W.F. at 30th	8.6	9.1	8.2
12	Initial I.F.	18.2	19.8	17.3
	Initial W.F.	13.6	14.3	13.2
	W.F. at 30th	9.3	10.7	8.4
18	Initial I.F.	34.4	42.1	29.3
	Initial W.F.	25.5	29.1	23.3
	W.F. at 30th	17.2	20.9	12.9

n=10

This is our exclusive property. It is not to be copied, reprinted or disclosed to a third party, not used for manufacturing, without our written consent, and has to be returned to us.

Title Subject: XM Connector (For wire-to-wire)	No. T-1-1283 (R-1-1283)	Revised: H
--	----------------------------	------------

6.2.2 Crimp Tensile Strength

Requirement:

Wire to be used	Requirement N min.
AWG #28	10
AWG #26	20
AWG #24	30
AWG #22	40

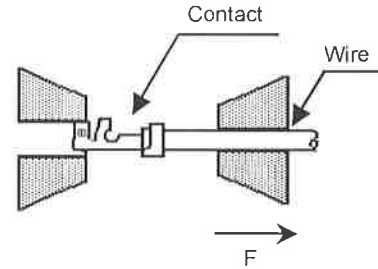

Test method: Pulling load shall be applied between a correctly crimped contact and a wire. The load required to pull the wire out of the contact or break the wire shall be measured. (Testing speed: 25 mm/min.)

Test result:

UNIT: N				
No. of circuits	Wire size	Ave.	Max.	Min.
Pin contact	0.08 mm ² (AWG#28)	21.6	25.0	15.2
	0.13 mm ² (AWG#26)	34.1	37.2	31.4
	0.20 mm ² (AWG#24)	60.7	63.7	56.8
	0.30 mm ² (AWG#22)	88.9	90.2	80.4
Socket contact	0.08 mm ² (AWG#28)	23.0	25.0	20.6
	0.13 mm ² (AWG#26)	34.4	35.3	32.3
	0.20 mm ² (AWG#24)	64.4	65.7	63.7
	0.30 mm ² (AWG#22)	84.5	87.2	79.4

n=10

6.2.3 Contact Insertion Force

Requirement: 8 N max.

Test method: The force to insert a contact into a housing along with the mating axis shall be measured. (Testing speed: 1 to 5 mm/sec.)

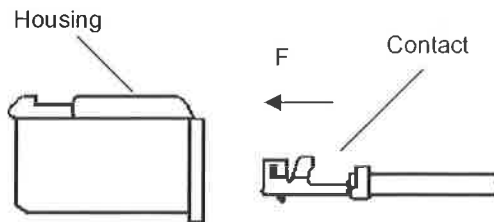

Test result:

UNIT: N			
	Ave.	Max.	Min.
Receptacle housing	3.0	3.5	2.6
Plug housing	2.6	3.9	1.8

n=18

This is our exclusive property. It is not to be copied, reprinted or disclosed to a third party, not used for manufacturing, without our written consent, and has to be returned to us.

Title Subject: XM Connector (For wire-to-wire)	No. T-1-1283 (R-1-1283)	Revised: H
--	----------------------------	------------

6.2.4 Contact Retention Force

Requirement: 15 N min.

Test method: A crimped contact shall be inserted into a housing and pulled in the axial direction. The load required to pull the contact out of the housing shall be measured. (Testing speed: 1 to 5 mm/sec.)

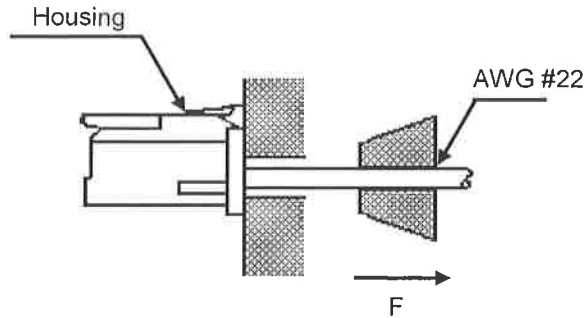

Note) Retainer shall be removed before the test.

Test result:

	Ave.	Max.	Min.
Receptacle housing	41.1	48.7	33.2
Plug housing	36.9	44.3	26.3

UNIT: N
n=18

6.2.5 Locking Strength

Requirement: 2 and 3-circuit; 20 N min.
4-circuit or more; 30 N min.

Test method: A receptacle housing and a plug housing shall be mated. Pulling load shall be applied between them. The load required to come them off each other shall be measured. (Testing speed: 1 to 5 mm/sec.)

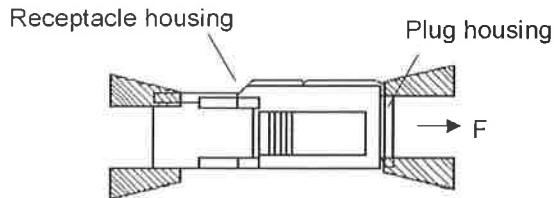

Test result:

	Ave.	Max.	Min.
2 and 3-circuit	80.8	83.6	76.9
4-circuit or more	93.7	101.6	88.8

UNIT: N
n=10

This is our exclusive property. It is not to be copied, reprinted or disclosed to a third party, not used for manufacturing, without our written consent, and has to be returned to us.

Title Subject: XM Connector (For wire-to-wire)	No. T-1-1283 (R-1-1283)	Revised: H
--	----------------------------	------------

6.2.6 Panel Lock Strength (Apply for the only product with panel lock)

Requirement: 12-circuit or less; 70 N min.
18-circuit; 85 N min.

Test method: A receptacle housing shall be mounted to a panel. The force of the opposite mounting direction shall be applied to the receptacle housing along with the mating axis. The load required to pull the receptacle housing out of the panel shall be measured. This test shall be conducted for products with panel lock. Stainless panel with hole based on dimensions specified in KRD-16073-1 shall be used for the test. (Testing speed: 1 to 5 mm/sec.)

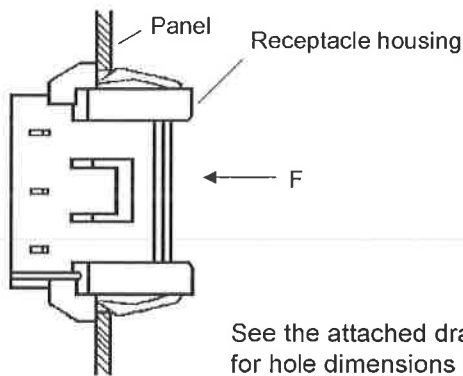

See the attached drawing (KRD-16073-1) for hole dimensions of a panel.

Test result:

	Ave.	Max.	Min.
12-circuit	168	177	154
18-circuit	196 min.	196 min.	196 min.

UNIT: N
n=10

6.3 Electrical Performance Test

6.3.1 Contact Resistance

Requirement: Initial; 10 mΩ max.
After tests; 20 mΩ max.

Test method: Contact resistance between points A and B of a specimen assembled for actual use as shown in the figure on the right side shall be measured under the following conditions.

Test current: 10 mA (DC)
Open voltage: 20 mV max.
Wire to be used: AWG #22

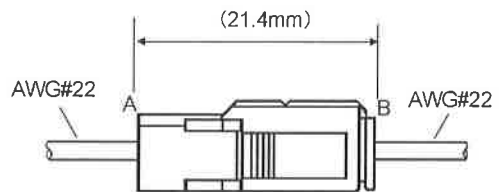

Test result: See each environmental test item.

Title Subject: XM Connector (For wire-to-wire)	No. T-1-1283 (R-1-1283)	Revised: H
--	----------------------------	------------

6.3.2 Current Continuity

Requirement: There shall be no current discontinuity longer than 1 microsecond during a vibration test.

Test method: Each circuit of a specimen assembled for actual use shall be connected in series and test current of 10 mA (DC) shall be applied. Current discontinuity longer than 1 microsecond during the test shall be detected by continuity meter.

Test result: See vibration test item.

6.3.3 Insulation Resistance

Requirement: Initial; 500 M Ω min.
After test; 300 M Ω min. (Humidity test)

Test method: 500 VDC shall be applied between the outer surface of a housing and a contact and also between adjacent contacts of a mated specimen to measure insulation resistance.

Test result:

Item	UNIT: M Ω	
	Housing-Contact	Contact-Contact
Initial	1,000 min.	1,000 min.
After humidity test	1,000 min.	1,000 min.

n=10

6.3.4 Dielectric Withstanding Voltage

Requirement: There shall be no breakdown or flashover.

Test method: Testing voltage specified below shall be applied between the outer surface of a housing and a contact and also between adjacent contacts of a mated specimen for one minute.

Initial; 1,500 VAC
After test; 1,000 VAC (Humidity test)

Test result:

Initial	Good.
After humidity test	Good.

This is our exclusive property. It is not to be copied, reprinted or disclosed to a third party, not used for manufacturing without our written consent, and has to be returned to us.

Title Subject: XM Connector (For wire-to-wire)	No. T-1-1283 (R-1-1283)	Revised: H
--	----------------------------	------------

6.4 Environmental Test

6.4.1 Durability

Requirement: Contact resistance shall be 20 mΩ max. after the test.

Test method: A receptacle housing with pin contacts and a plug housing with socket contacts shall be mated and unmated. After repeated 30 cycles, contact resistance shall be measured.

Test result:

UNIT: mΩ

Contact resistance	Initial			After test		
	Ave.	Max.	Min.	Ave.	Max.	Min.
	4.75	4.9	4.6	6.06	8.5	5.1

n=18

6.4.2 Humidity

Requirement: Contact resistance shall be 20 mΩ max. after the test.

Insulation resistance shall be 300 MΩ min. after the test.

There shall be no breakdown or flashover on the dielectric withstanding voltage test.

Test method: The specimen shall be placed in a humidity chamber of the following conditions. After the test, contact resistance, insulation resistance and dielectric withstanding voltage shall be measured.

Temperature: 40 ± 2 °C
 Relative humidity: 90 to 95 %
 Period: 240 hours

Test result:

UNIT: mΩ

Contact resistance	Initial			After test		
	Ave.	Max.	Min.	Ave.	Max.	Min.
	5.26	6.2	5.0	5.92	7.8	5.0

n=18

This is our exclusive property. It is not to be copied, reprinted or disclosed to a third party, not used for manufacturing, without our written consent, and has to be returned to us.

Title Subject: XM Connector (For wire-to-wire)	No. T-1-1283 (R-1-1283)	Revised: H
--	----------------------------	------------

6.4.3 Heat Aging

Requirement: Contact resistance shall be 20 mΩ max. after the test.

Test method: The specimen shall be placed in a heat oven of the following conditions. After the test, contact resistance shall be measured.

Temperature: 85 ± 2 °C
 Period: 250 hours

Test result:

UNIT: mΩ

Contact resistance	Initial			After test		
	Ave.	Max.	Min.	Ave.	Max.	Min.
	5.29	5.7	4.9	5.54	6.3	5.1

n=18

6.4.4 Thermal Shock

Requirement: Contact resistance shall be 20 mΩ max. after the test.

Test method: The specimen shall be subjected to a thermal shock test of the following conditions. After the test, contact resistance shall be measured.

1 cycle consists of:
 - 55 ± 3 °C for 30 minutes
 +85 ± 2 °C for 30 minutes
 Total cycles: 25 cycles

Test result:

UNIT: mΩ

Contact resistance	Initial			After test		
	Ave.	Max.	Min.	Ave.	Max.	Min.
	5.25	5.4	5.0	5.69	6.1	5.1

n=18

This is our exclusive property. It is not to be copied, reprinted or disclosed to a third party, not used for manufacturing, without our written consent, and has to be returned to us.

Title Subject: XM Connector (For wire-to-wire)	No. T-1-1283 (R-1-1283)	Revised: H
--	----------------------------	------------

6.4.5 Hydrogen Sulfide Gas

Requirement: Contact resistance shall be 20 mΩ max. after the test.

Test method: The specimen shall be subjected to hydrogen sulfide gas of the following conditions. After the test, contact resistance shall be measured.

Concentration: 3 ± 1 ppm
 Temperature: 40 ± 2 °C
 Relative humidity: 80 ± 5 %
 Period: 96 hours

Test result:

UNIT: mΩ

Contact resistance	Initial			After test		
	Ave.	Max.	Min.	Ave.	Max.	Min.
	5.31	5.6	5.0	6.07	7.9	5.4

n=18

6.4.6 Salt Spray

Requirement: Contact resistance shall be 20 mΩ max. after the test.

Test method: The specimen shall be subjected to a salt spray test of the following conditions. After the test, the specimen shall be washed with running water and dried naturally before the measurement of contact resistance.

Temperature: 35 ± 2 °C
 Concentration: 5 % in weight
 Period: 48 hours

Test result:

UNIT: mΩ

Contact resistance	Initial			After test		
	Ave.	Max.	Min.	Ave.	Max.	Min.
	5.02	5.2	4.7	5.43	6.0	4.9

n=18

This is our exclusive property. It is not to be copied, reprinted or disclosed to a third party, not used for manufacturing, without our written consent, and has to be returned to us.

Title Subject: XM Connector (For wire-to-wire)	No. T-1-1283 (R-1-1283)	Revised: H
--	----------------------------	------------

6.4.7 Vibration

Requirement: Contact resistance shall be 20 mΩ max. after the test.
There shall be no current discontinuity longer than 1 microsecond during the test.

Test method: The specimen shall be mounted on a printed circuit board (PCB) and subjected to a vibration test of the following conditions. During the test, current continuity shall be checked. After the test, contact resistance shall be measured.

Frequency: 10-55-10 Hz/minute
 Amplitude: 1.52mm
 Direction: Each of X, Y and Z-axis directions
 *Each axis shall be at right angles to others.
 Period: 2 hours for each direction

Test result:

							UNIT: mΩ
Contact resistance	Initial			After test			
	Ave.	Max.	Min.	Ave.	Max.	Min.	
	5.30	5.8	5.0	5.84	7.6	5.2	
							n=18
Current continuity	There was no current discontinuity longer than 1 microsecond.						

6.4.8 Ammonia Gas

Requirement: There shall be no stress corrosion cracking.

Test method: The mated specimen shall be subjected to an ammonia gas test of the following conditions. (The connector shall not be soldered.)
After the test, stress corrosion cracking shall be checked.

Ammonia solution: 3% in weight
 Solution volume: 25 ml per one liter of volume
 Period: 7 hours

Test result:

There was no stress corrosion cracking.							
							n=18