

Inductors for decoupling circuits

Soft termination

KLZ-HR series (for automotive)



AEC-Q200

KLZ1608-HR type



FEATURES

- The KLZ series include inductors for decoupling circuits that have top-class DC superimposition characteristics and low DC resistance.
- They are compatible with wide frequency band noise, from low to high frequency.
- Guide electric property resin absorbs external stress, and mechanical stress, resistance force to thermal shock is improved.
- Easing by conductive resin thermal stress, and respond for High-temperature environment of 150°C, too.
- Operating temperature range: -55 to +150°C (including self-temperature rise)
- Compliant with AEC-Q200

APPLICATION

- Automotive equipment, smart phones, tablet terminals, note PCs, various modules such as camera modules, DSCs, video games, portable memory audio devices, navigation systems, PNDs, WLANs, SSDs
- Application guides: [Car Infotainment](#)

PART NUMBER CONSTRUCTION

KLZ	1608	A	HR	1R0	W	T	D25
Series name	LxWxH dimensions 1.6x0.8x0.8 mm	Product internal code	Specifications (Grade)	Inductance (μH)	Characteristic type	Packaging style	Internal code

CHARACTERISTICS SPECIFICATION TABLE

Type	L (μH)	L measuring conditions		DC resistance (Ω)±30%	Isat*1 (mA)	Itemp*2 (mA)	Part No.
		Tolerance	Frequency (MHz)				
Large current	1.00	±20%	10	1.0	0.15	190	KLZ1608AHR1R0WTD25
	2.20	±20%	10	1.0	0.25	130	KLZ1608AHR2R2WTD25
	4.70	±20%	2	0.1	0.50	120	KLZ1608MHR4R7WTD25
	10.0	±20%	2	0.1	1.05	90	KLZ1608MHR100WTD25
	22.0	±20%	2	0.1	2.40	55	KLZ1608MHR220WTD25

*1 Current assumed when inductance ratio has decreased by 50% max..

*2 Current assumed when temperature has risen to 20°C max. (reference value). Operating temperature environment at this time: 130°C max.

Measurement equipment

Measurement item	Product No.	Manufacturer
L	4294A+16034G	Keysight Technologies
DC resistance	Type-7561	Yokogawa

* Equivalent measurement equipment may be used.

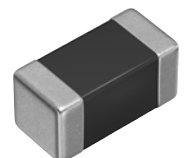

KLZ1608-HR type

L FREQUENCY CHARACTERISTICS

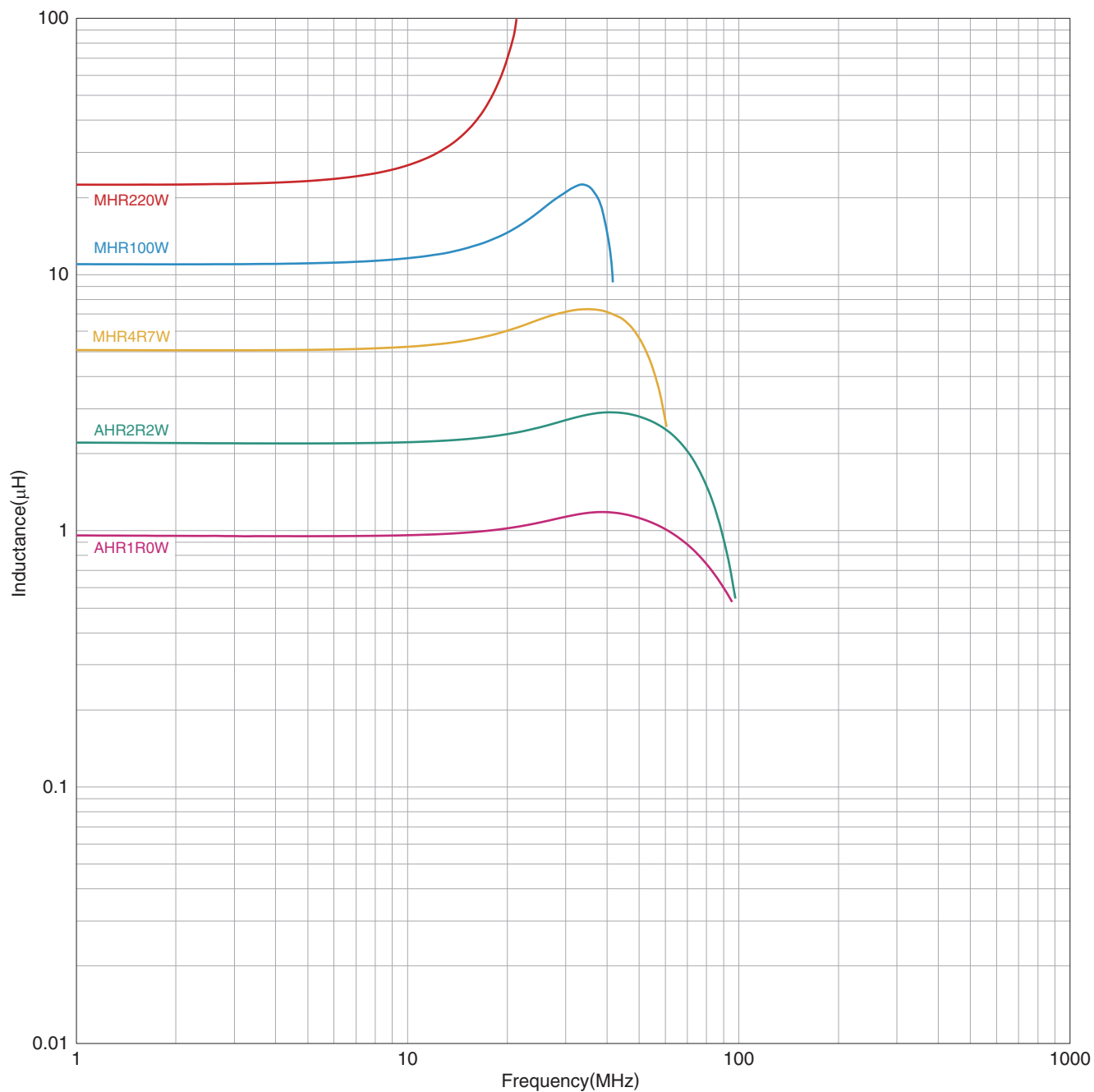

Measurement equipment

Product No.	Manufacturer
E4991A+16192A	Keysight Technologies

* Equivalent measurement equipment may be used.

KLZ1608-HR type

INDUCTANCE VS. DC BIAS CHARACTERISTICS

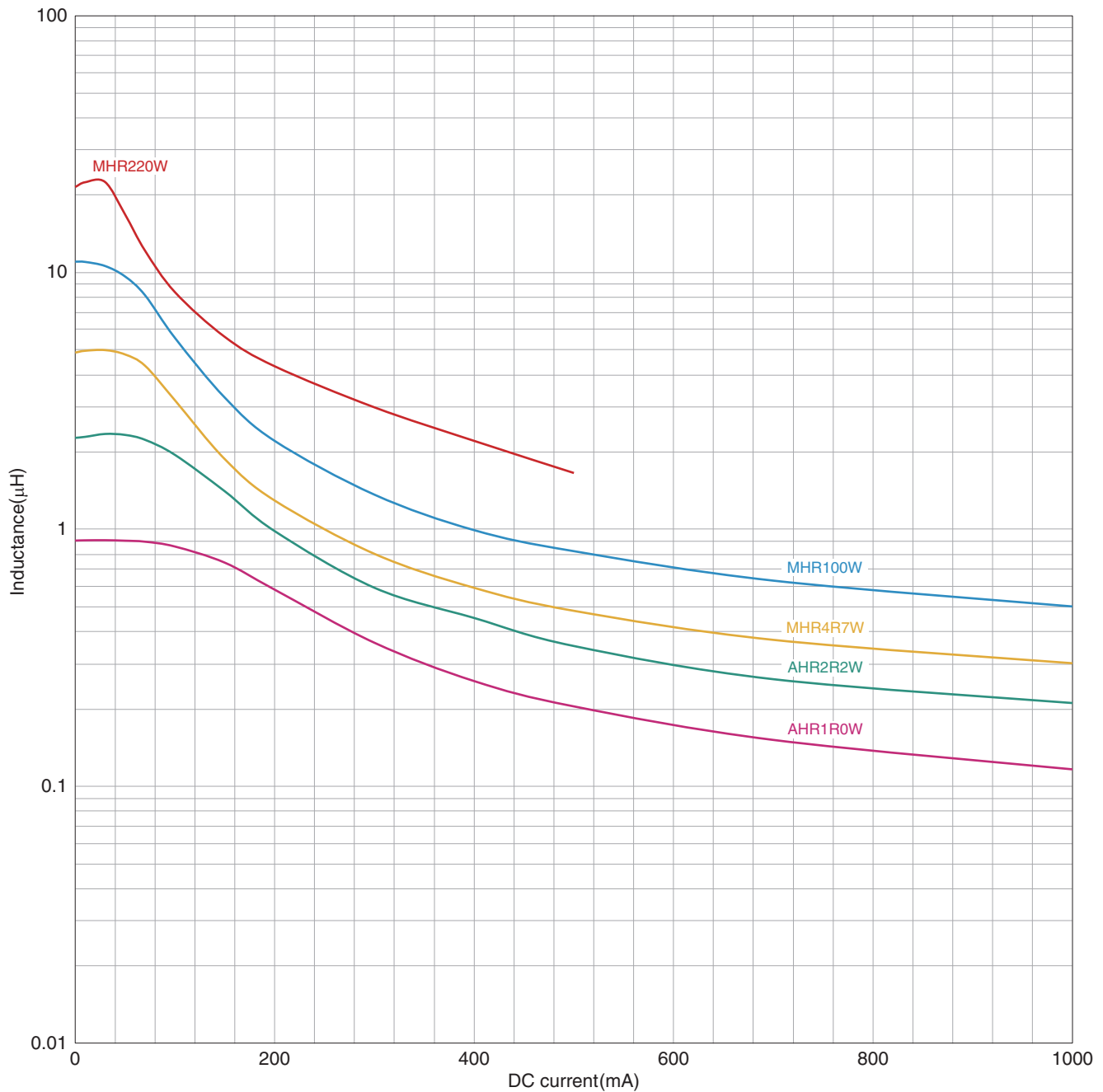

Measurement equipment

Product No.	Manufacturer
4291B+16200A+16192A	Keysight Technologies

* Equivalent measurement equipment may be used.

KLZ1608-HR type

■ IMPEDANCE VS. FREQUENCY CHARACTERISTICS

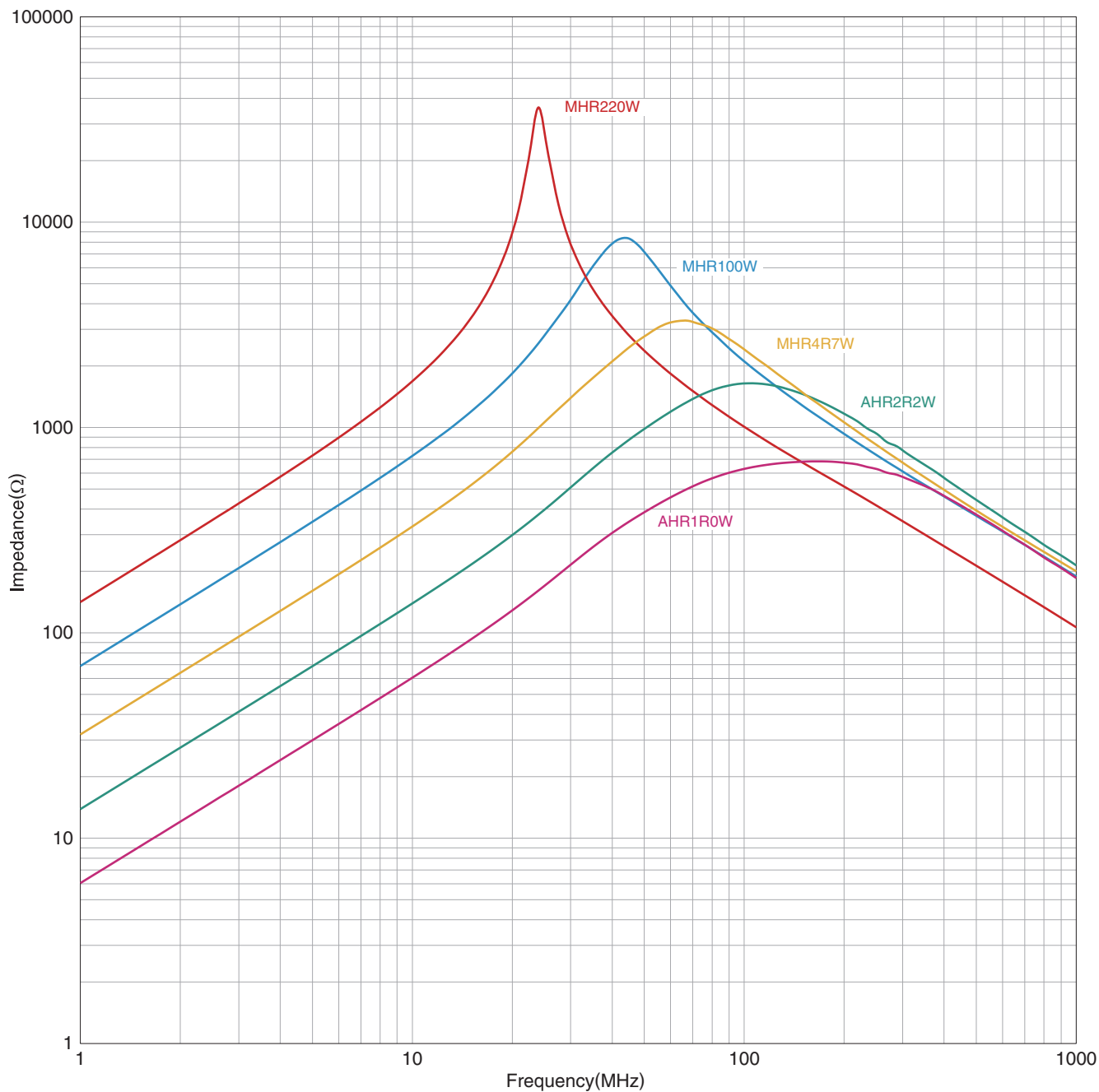

Measurement equipment

Product No.	Manufacturer
E4991A+16192A	Keysight Technologies

* Equivalent measurement equipment may be used.

KLZ1608-HR type

SHAPE & DIMENSIONS

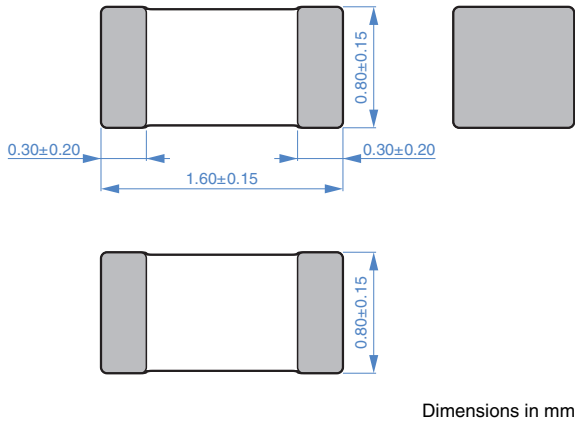

PACKAGING STYLE

REEL DIMENSIONS

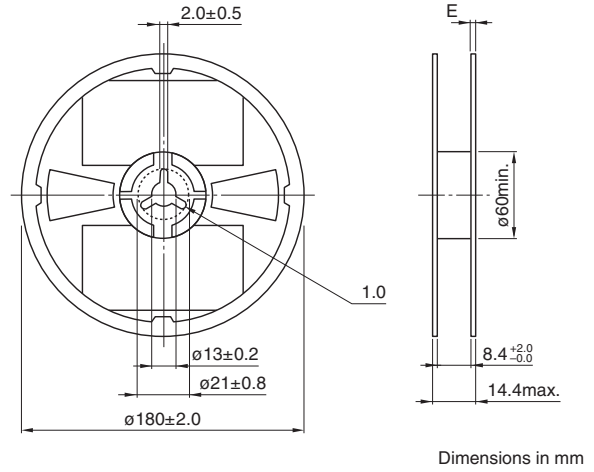

RECOMMENDED LAND PATTERN

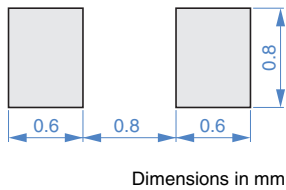

TAPE DIMENSIONS

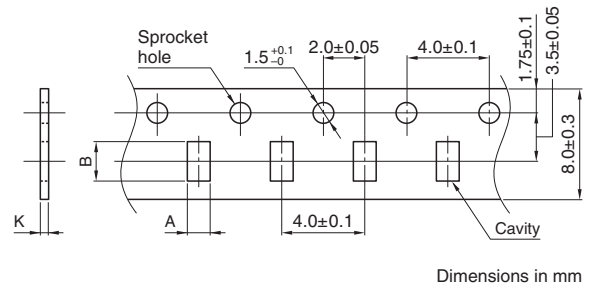

Type	A	B	K
KLZ1608-HR	1.1±0.2	1.9±0.2	1.1 max.

RECOMMENDED REFLOW PROFILE

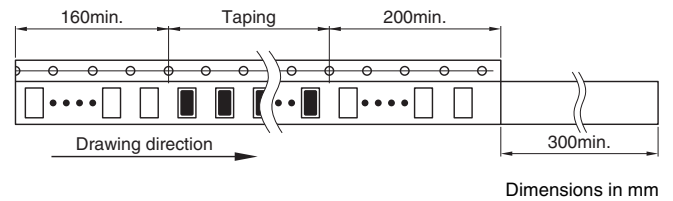
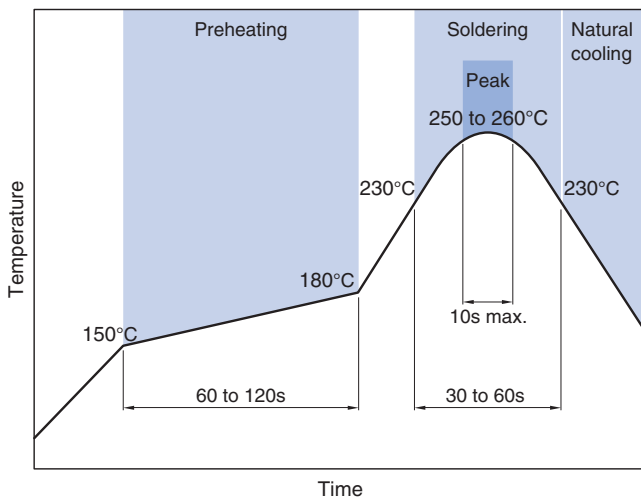

PACKAGE QUANTITY

Package quantity	4000 pcs/reel
------------------	---------------

TEMPERATURE RANGE, INDIVIDUAL WEIGHT

Operating temperature range*	Storage temperature range**	Individual weight
-55 to +150 °C	-55 to +150 °C	4 mg

* Operating temperature range includes self-temperature rise.

** The storage temperature range is for after the assembly.

REMINDERS FOR USING THESE PRODUCTS

Before using these products, be sure to request the delivery specifications.

SAFETY REMINDERS

Please pay sufficient attention to the warnings for safe designing when using this products.

REMINDERS

- The storage period is less than 12 months. Be sure to follow the storage conditions (temperature: 5 to 40°C, humidity: 10 to 75% RH or less).
If the storage period elapses, the soldering of the terminal electrodes may deteriorate.
- Do not use or store in locations where there are conditions such as gas corrosion (salt, acid, alkali, etc.).
- Before soldering, be sure to preheat components.
The preheating temperature should be set so that the temperature difference between the solder temperature and chip temperature does not exceed 150°C.
- Soldering corrections after mounting should be within the range of the conditions determined in the specifications.
If overheated, a short circuit, performance deterioration, or lifespan shortening may occur.
- When embedding a printed circuit board where a chip is mounted to a set, be sure that residual stress is not given to the chip due to the overall distortion of the printed circuit board and partial distortion such as at screw tightening portions.
- Self heating (temperature increase) occurs when the power is turned ON, so the tolerance should be sufficient for the set thermal design.
- Carefully lay out the coil for the circuit board design of the non-magnetic shield type.
A malfunction may occur due to magnetic interference.
- Use a wrist band to discharge static electricity in your body through the grounding wire.
- Do not expose the products to magnets or magnetic fields.
- Do not use for a purpose outside of the contents regulated in the delivery specifications.
- The products listed on this catalog are intended for use in general electronic equipment (AV equipment, telecommunications equipment, home appliances, amusement equipment, computer equipment, personal equipment, office equipment, measurement equipment, industrial robots) under a normal operation and use condition.
The products are not designed or warranted to meet the requirements of the applications listed below, whose performance and/or quality require a more stringent level of safety or reliability, or whose failure, malfunction or trouble could cause serious damage to society, person or property.
If you intend to use the products in the applications listed below or if you have special requirements exceeding the range or conditions set forth in the each catalog, please contact us.

- (1) Aerospace/aviation equipment
- (2) Transportation equipment (electric trains, ships, etc.)
- (3) Medical equipment
- (4) Power-generation control equipment
- (5) Atomic energy-related equipment
- (6) Seabed equipment
- (7) Transportation control equipment

- (8) Public information-processing equipment
- (9) Military equipment
- (10) Electric heating apparatus, burning equipment
- (11) Disaster prevention/crime prevention equipment
- (12) Safety equipment
- (13) Other applications that are not considered general-purpose applications

When designing your equipment even for general-purpose applications, you are kindly requested to take into consideration securing protection circuit/device or providing backup circuits in your equipment.

Mouser Electronics

Authorized Distributor

Click to View Pricing, Inventory, Delivery & Lifecycle Information:

[TDK:](#)

[KLZ1608AHR2R2WTD25](#) [KLZ1608AHR1R0WTD25](#) [KLZ1608MHR100WTD25](#) [KLZ1608MHR220WTD25](#)
[KLZ1608MHR4R7WTD25](#)