

客户 Customer: _____

承认书编号 No: H-19-0515001

系列 Series: HGS

提出日期 Date: 2019-05-15

规格 Spec: : 100μF 50V 8*12 2000H

产品料号 P/N: EHGS104M050F12BC3

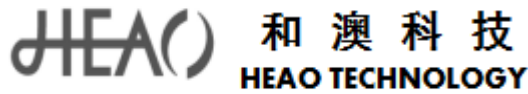

承认书
APPROVAL SHEET

承认 APPROVED BY:

签认后，请寄回一份，谢谢！

Please return us one copy your signed specification after you approved of it , thanks!!

核准 APPROVED BY	查核 CHECKED BY	经办 DESIGNED BY
李楠	莫胜辉部 2019.05.15 莫胜辉	陈曦

益阳市和澳电子科技有限公司

中国湖南省益阳市龙岭工业园上新路 E1 栋

HUNAN YIYANG HEAO TECHNOLOGY CO.,LTD

HTTP: //WWW.HEAOCAP.COM

TEL: +86-737-6685226

FAX: +86-737-6685226

Customer		SERIES	HGS	DATE	2019-5-21
----------	--	--------	-----	------	-----------

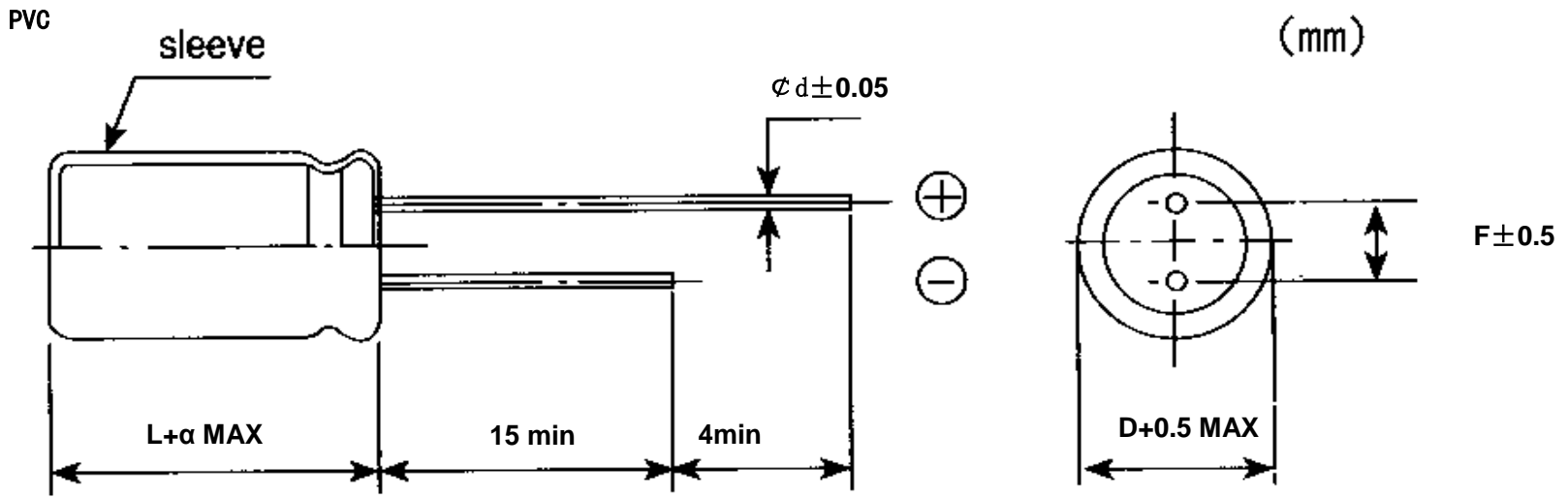
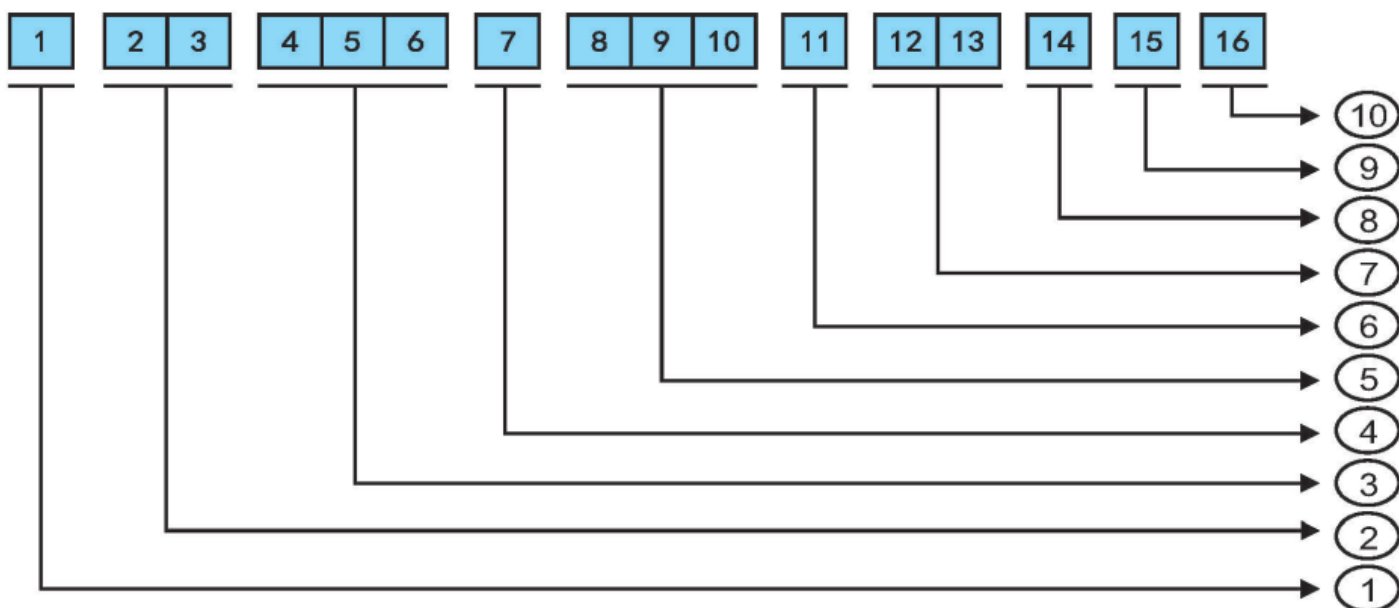

FIG-1

特性 (Characteristics)

No.	Customer Part No.	HEAO Part No.	容量 (uF) Capacitor	公差 (%) Tolerance	电压 (V) Voltage	寿命 (H) life	温度 (°C) Temperature	浪涌电压 (V) Surge Voltage	漏电流 (uA) Leakage Current	损耗 (%) Dissipation Factor	等效串联电阻 ESR Ω 100kHz	纹波电流 (mA) Ripple Current	尺寸 Dimensions (mm)					Appearance Drawing No.
													DΦ	L	α	d	F	
1		EHGS104M050F12BC	100	±20	50	2000	-40~+105	65	60	15	0.4	490	8	12	1.0	0.5	3.5	FIG-1

产品料号说明 FOR ALUMINUM ELECTROLYTIC CAPACITORS



1 产品分类
Category

类型 Type	代码 Code
电容器导针型	E
电容器牛角型	S
电容器贴片型	T
电容器固态型	P

2 系列代码
Series code

系列名称 Series name	代码 Code
HGS	见系列说明
HGH	
HGE	

3 容量代码
Capacitance code

容量值 (uF) Capacitance	代码 Code
0.1	101
1	102
10	103
100	104
1000	105
10000	106
100000	107
1000000	108
10000000	109
4.7	472
47	473

4 电容允许偏差代码
Capacitance tolerance

TOL. %	代码 Code
-10 ~ +10	K
-20 ~ +20	M
-10 ~ +30	Q
-10 ~ +20	V
-0 ~ +20	S
-0 ~ +30	A
-5 ~ +20	B
-10 ~ -20	C
-5 ~ +5	D
-0 ~ +10	E
-5 ~ -20	F
-15 ~ +5	N

5 电压代码
Voltage code

电压 Voltage	代码 Code
4	004
6.3	6R3
10	010
16	016
25	025
35	035
50	050
63	063
80	080
100	100
160	160
200	200
250	250
350	350
400	400
450	450
500	500

6 直径代码
Diameter

直径 (Φ) Diameter	代码 Code
4	C
5	D
6.3	E
8	F
10	G
12	H
12.5	I
13	J
16	K
18	L
22	M
25	N
30	O
35	P
40	Q

7 高度代码 (mm)
Height code

高度 Height	代码 Code
5	05
7	07
9	09
12	12
14	14
16	16
20	20
25	25
30	30
35	35
40	40
45	45
50	50
55	55
60	60

8 端子类别代码
Terminal code

端子类别 Terminal	代码 Code
长脚	B
编带	T
剪脚	C
左弯脚	L
右弯脚	R
直K脚	K
左弯K脚	W
右弯K脚	E

9 套管类别
Sleeve code

套管类别 Sleeve code	代码 Code
PVC	C
PET	T

10 端子长度
Seeve code

长度 Length	代码 Code
切脚2.0	2
切脚3.0	3
切脚4.0	4
切脚5.0	5
切脚6.0	6
切脚7.0	7
切脚8.0	8
牛角4.5	4
牛角6.8	6
编带直脚	实际脚距
编带弯脚	实际脚距

电解电容器检查记录表
Inspection record of Electrolytic Capacitors

料号(P/N):	EHGS104M050F12BC	检查号码(QC No.):	20190515001
系列(Series):	HGS	套管颜色 (sleeve colour):	黑色底白字
规格(Spec.):	100 μ F 50V Φ 8*13	数量(Qty):	10Pcs
批号(Lot No.):	HE190515001	寿命(life):	2000H
测试环境(Test Ambient):	温度(Temp.) 20 $^{\circ}$ C 湿度(R.H.) 65%		

一. 项目检验 (Inspection items)

检验项目	检验标准 (依 GB/T2828.1-2003 抽样标准)	AQL (CR=0; MAJ=0.25; MIN=0.65)		判定结果
外观检查	字体清楚, 无损伤, 尺寸符合要求	Ac	Re	OK
外套管绝缘电阻	$\geq 100M\Omega$	0	1	OK
耐焊接热	外观无损伤, 容值变化率 $\leq 5\%$	0	1	OK
可焊性	引出端有很好的镀层焊料	0	1	OK
压力释放	无防爆阀打开, 无击穿, 无燃烧	0	1	OK
引出端	外观良好, 无损伤, 特性稳定	0	1	OK
振动	外观良好, 无损伤, 无漏液, 容值变化率 $\leq 5\%$	0	1	OK

二. 尺寸 CASE SIZE TABLE(Unit:mm)

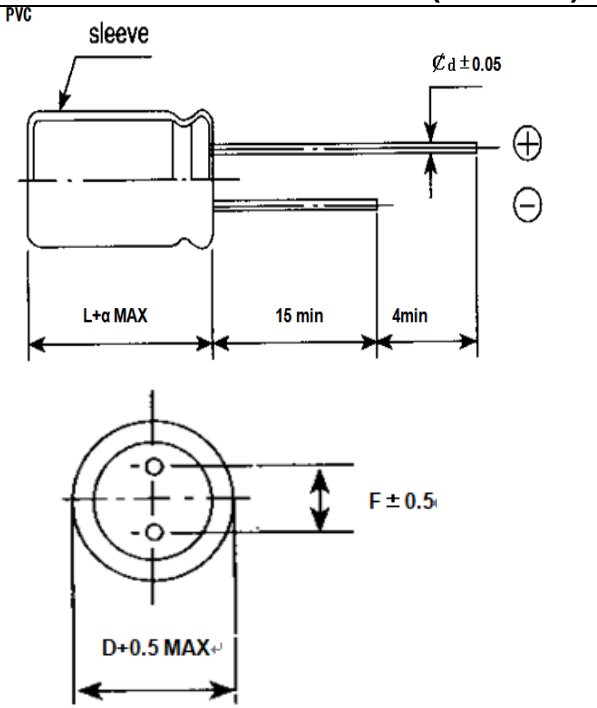
	直径 Φ D ± 0.5	长度 L \pm 1.0	脚距 F \pm 0.5	引脚加工 (Pin Processing Type)	判定结果
	8mm	12mm	3.5mm		OK

三. 特性数据 (Performance Data) :

项目 序号	静电容量 (Capacitance) (120HZ)	损 失 (Dissipation Factor) (120HZ)	漏电流 (leakage Current)	ESR 100kHz Ω	成品高度 Product height
	120HZ -20%~+20%	120HZ 15 %max	1min<60uA	<0.4Ω	12±1.0mm
1	95.4	4.3	2.6	0.27	13.04
2	96.4	4.2	2.8	0.28	13.06
3	95.7	3.8	2.6	0.27	13.05
4	96.4	4.4	2.7	0.28	13.05
5	97.3	4.5	2.8	0.27	13.06
6	95.6	4.3	2.5	0.27	13.04
7	96.3	4.2	2.4	0.28	13.05
8	94.5	4.6	2.6	0.27	13.05
9	95.2	4.1	2.4	0.28	13.06
10	96.5	4.3	2.3	0.27	13.05
Max	97.3	4.6	2.8	0.28	13.06
Mix	94.5	3.8	2.3	0.27	13.04
Ave	95.93	4.27	2.57	0.275	13.05

四. 其它 :

注 明	测试仪器 Test instrument:
	容量损耗测试仪 L.C.R. meter: CHROMA 11020 LCR METER
	漏电流测试仪 L.C. meter:CHROMA 11200 METER
	记录有效期: 2年 Record validity: 2years.



项目 Items	特性 Characteristics															
温度范围 Temperature range	-40℃ to +105℃															
标称电压 Rated Voltage	50WV.DC															
容量公差 Capacitance Tolerance	-20%~+20% 测试环境温度、测试频率(20±5 ℃、120Hz)															
漏电流 Leakage Current	充电时间 Time	2 分钟后 After 2 minutes					2 者之中取大值 Whichever is greater.									
	漏电流标准 LC standard	LC≤0.02CV+10uA														
	LC: Leakage Current (μA) C: 容量 Capacitance (μF) V: 电压 Voltage (V) 环境温度 (20 ℃)															
损失角之正切值(损耗) Dissipation Factor	电压 Voltage	6.3	10	16	25	35	50	63	80	100	160	250	350	400	450	500
	损耗 DF	0.22	0.19	0.16	0.14	0.12	0.10	0.10	0.10	0.10	0.15	0.15	0.15	0.15	0.15	0.15
	容量每增加 1000uF 损耗增加 2% Add 2% for every increase of 1000UF (25 ℃ , 120Hz)															
低温特性(阻抗比) Low Temperature Characteristics(Max Impedance Ratio)	电压 Voltage	6.3	10	16	2	35	50	63	80	100	160	250	350	400	450	500
	Z-25℃/Z20℃	7	4	3	2	2	2	2	2	3	3	3	6	6	6	6
	Z-40℃/Z20℃	15	10	8	6	4	3	3	3	6	6	6	--	--	--	--
Z-25℃:Z20℃: -25 度与 20 度的阻抗比; Z-40℃:Z+20℃: -40 度与 20 度的阻抗比 (20℃ , 120Hz)																
可靠性 Endurance	在 105℃环境温度中施加额定电压 2000 小时后, 电容器温度恢复到 20℃测试时, 各项特性变化应满足以下要求: The following specification shall be satisfied when the capacitors are restored to 20℃ after subjected to Rate Voltage with the rated ripple current is applied for 2000 hours at 105℃															
	容量变化 Capacitance Change	≅初始值±20%					≅±20% of the initial value									
	损耗变化 Dissipation Factor Change	≅200%标准值					≅200% of the initial specified value									
漏电流变化 Leakage Current Change 小于标准值 Not more than the specified value																
高温储存 High temperature storage	在 105℃环境温度中不加压放置 1000 小时后, 各项特性变化应满足以下要求: The following specification shall be satisfied when the capacitors are restored to 25℃after exposing them for 1000hours at 105℃ without voltage applied . 符合上面列出的各项要求 They meet the specified value for Endurance characteristics listed above.															



Contents Of Quality Assurance

范围(Scope)	保证方式及项目 Assurance Method Contents																										
<p>1、电器特性 Electrical Characteristics 1.1 静电容量 Capacitance</p>	<p>◎依据 EIAJ 5141,5102 ◎容量公差 -20%~+20% ◎Measured in Accordance With EIAJ 5141,5102 ◎Capacitors Tolerance:-20%~+20%</p>																										
<p>1.2 漏电流 Leakage Current</p>	<p>◎依据 EIAJ 5141,5102 ◎以额定直流电压充电 2 分钟后，漏电流最大允许值，依据本公司系列规定于各表所示之值以下 ◎Measured in Accordance With EIAJ 5141,5102 ◎After the Application of the rated D.C Voltage for 2 minutes,The Leakage Current Maximum value test in accordance with value standard aeries</p>																										
<p>1.3 损失角之正切值 Dissipation Factor</p>	<p>◎依据 EIAJ 5141,5102 ◎其 D.F 最大值，在本公司各系列规定所示值以下，其测量温度在+25±5℃，测试频率在 120Hz ◎Measured in Accordance With EIAJ 5141,5102 ◎The Dissipation Factor Maximum value at +25±5℃， Test in accordance with value Standard series</p>																										
<p>1.4 浪涌电压 Surge Voltage</p>	<p>◎依据 EIAJ 5141,5102</p> <table border="1" data-bbox="397 952 1567 1093"> <tr> <td>额定电压 WV</td> <td>16</td> <td>25</td> <td>35</td> <td>50</td> <td>63</td> <td>100</td> <td>160</td> <td>200</td> <td>250</td> <td>300</td> <td>400</td> <td>500</td> </tr> <tr> <td>浪涌电压 SV</td> <td>21</td> <td>35</td> <td>45</td> <td>65</td> <td>75</td> <td>130</td> <td>200</td> <td>250</td> <td>300</td> <td>330</td> <td>450</td> <td>560</td> </tr> </table> <p>◎电容器接 1KΩ 电阻，在常温下，以每 5±0.5 分钟为一个周期，每一周期加浪涌电压 30±5 秒，经过 1000 周期以后测量其值，应满足以下要求 ◎静电容量变化率：初始值±20%以内 ◎损耗变化率：规格值±200%以内 ◎漏电流变化率：规格值以内 ◎Measured in Accordance With EIAJ 5141,5102 ◎The Capacitor may be subjected for short periods not exceeding approximately 30±5 seconds at infrequency intervals of not than 5 minutes,the test shall be Conducted 1000 cycles at room temperature with Voltage applied through a series Resistance of 1000Ohms without discharge. unless otherwise specified as follows ◎Capacitor change:≤within 20% of initial value ◎Dissipation Factor ≤200% of specified value ◎Leakage current change:initial specified value</p>	额定电压 WV	16	25	35	50	63	100	160	200	250	300	400	500	浪涌电压 SV	21	35	45	65	75	130	200	250	300	330	450	560
额定电压 WV	16	25	35	50	63	100	160	200	250	300	400	500															
浪涌电压 SV	21	35	45	65	75	130	200	250	300	330	450	560															
<p>2、机械特性 Mechanical Characteristics 2.1、端子强度 Terminal Strength 2.1.1、拉力试验 Pull Test</p>	<p>◎依据 EIAJ 5141,5102 ◎将电容器本体垂直固定，于端子部施加如下表所示之负重，经 30±5 秒后，端子不可有断裂或其他异常</p> <table border="1" data-bbox="397 1697 1312 1848"> <thead> <tr> <th>端子线直径(mm) Terminal diameter</th> <th>负重(Kg) Weight</th> </tr> </thead> <tbody> <tr> <td>0.5 以下(含) ≦0.5</td> <td>0.5</td> </tr> <tr> <td>0.6~0.8</td> <td>1</td> </tr> <tr> <td>0.8 以上</td> <td>2.5</td> </tr> </tbody> </table> <p>◎Measured in Accordance With EIAJ 5141,5102 ◎That with Diameter of lead wire less than 0.5mm and case size than 10mm be capable of withstanding a steady pull of 0.5Kg for a period of 10 seconds ◎That with Diameter of lead wire between 0.6~0.8mm be capable of withstanding a steady pull of 1Kg for a period of 10 seconds ◎That with Diameter of lead wire lager than 0.8mm be capable of withstanding a steady pull of 2.5Kg for a period of 10 seconds</p>	端子线直径(mm) Terminal diameter	负重(Kg) Weight	0.5 以下(含) ≦0.5	0.5	0.6~0.8	1	0.8 以上	2.5																		
端子线直径(mm) Terminal diameter	负重(Kg) Weight																										
0.5 以下(含) ≦0.5	0.5																										
0.6~0.8	1																										
0.8 以上	2.5																										

<p>2.1.2、折弯测试 Bending Test</p>	<p>◎将电容器本体保持垂直状态，依下表的负重加于端子线，然后将本体向水平方向倾斜 90 度再回复原位置，再朝反方向倾斜 90 度，再回复原来位置，此为一个周期。如此做 2 周期，(每周期间时间为 5 秒钟).端子不可有断裂或其他异常。</p> <table border="1" data-bbox="397 203 1315 353"> <thead> <tr> <th>端子线直径(mm) Terminal diameter</th> <th>负重(Kg) Weight</th> </tr> </thead> <tbody> <tr> <td>0.5 以下(含) ≤0.5</td> <td>0.25</td> </tr> <tr> <td>0.6~0.8</td> <td>0.50</td> </tr> <tr> <td>0.8 以上</td> <td>1.00</td> </tr> </tbody> </table> <p>◎That with Diameter of lead wire less than 0.5mm can be given a weight of 0.25Kg ◎That with Diameter of lead wire between 0.6~0.8mm can be given a weight of 0.5Kg ◎That with Diameter of lead wire lager than 0.8mm can be given a weight of 1Kg</p>	端子线直径(mm) Terminal diameter	负重(Kg) Weight	0.5 以下(含) ≤0.5	0.25	0.6~0.8	0.50	0.8 以上	1.00																																								
端子线直径(mm) Terminal diameter	负重(Kg) Weight																																																
0.5 以下(含) ≤0.5	0.25																																																
0.6~0.8	0.50																																																
0.8 以上	1.00																																																
<p>2.2、耐焊接热性 Solder heat Resistance</p>	<p>◎依据 EIAJ 5141,5102 ◎将电容器端子 CP 线浸入温度为 350±10℃的锡熔液里，30±1 秒后取出，于常温下放置 1-2 小时后，测量其值，应满足以下要求： ◎静电容量变化率：初始值±20%以内 ◎损耗变化率：规格值以内 ◎漏电流变化率：规格值以内 ◎外观：无明显异常 ◎Measured in Accordance With EIAJ 5141,5102 ◎The section from the base to 4mm of the capacitor terminal must be immersed in 350±10℃,Liquid tin 30±1 seconds,the after removing The following specifications Shall be satisfied,When the capacitor terminal is restored to 20℃,With 1-2 hours ◎Capacitor change:≤within 20% of initial value ◎Dissipation Factor :initial of specified value ◎Leakage current change:initial specified value ◎Appearance is good</p>																																																
<p>2.3、焊锡附着性 Solder ability Test</p>	<p>◎依据 EIAJ 5141,5102 ◎将电容器端子 CP 线浸入温度为 230±5℃的锡熔液里，锡熔液离本体 4±1mm 处，经 2 秒后，其浸入部份，至少有 3/4 部有新锡附着。 ◎Measured in Accordance With EIAJ 5141,5102 ◎The section from the base to 4mm of the capacitor terminal must be immersed in 230±5℃,Liquid tin 2 seconds,then after removing. The liquid tin must be at here to No less than 3/4 this section.</p>																																																
<p>3、耐温性 Temperature resistance characteristics 3.1、低温特性 Low Temperature characteristics</p>	<p>◎依据 EIAJ 5141,5102 ◎将电容器置于低温箱中，温度达到-25℃和-40℃后测量其阻抗值，并将其值与+20℃时的阻抗值对比，应满足如下要求：</p> <table border="1" data-bbox="397 1384 1567 1496"> <thead> <tr> <th>电压 Voltage</th> <th>6.3</th> <th>10</th> <th>16</th> <th>25</th> <th>35</th> <th>50</th> <th>63</th> <th>80</th> <th>100</th> <th>160</th> <th>250</th> <th>350</th> <th>400</th> <th>450</th> <th>500</th> </tr> </thead> <tbody> <tr> <td>Z-25℃/Z20℃</td> <td>7</td> <td>4</td> <td>3</td> <td>2</td> <td>2</td> <td>2</td> <td>2</td> <td>2</td> <td>3</td> <td>3</td> <td>3</td> <td>6</td> <td>6</td> <td>6</td> <td>6</td> </tr> <tr> <td>Z-40℃/Z20℃</td> <td>15</td> <td>10</td> <td>8</td> <td>6</td> <td>4</td> <td>3</td> <td>3</td> <td>3</td> <td>6</td> <td>6</td> <td>6</td> <td>--</td> <td>--</td> <td>--</td> <td>--</td> </tr> </tbody> </table> <p>◎Measured in Accordance With EIAJ 5141,5102 ◎capacitor at -25℃ or -40℃.120Hz shall not be less than 80% of the value at 20℃ ◎Impedance ratio at 120Hz the following specifications shall be satisfied.</p>	电压 Voltage	6.3	10	16	25	35	50	63	80	100	160	250	350	400	450	500	Z-25℃/Z20℃	7	4	3	2	2	2	2	2	3	3	3	6	6	6	6	Z-40℃/Z20℃	15	10	8	6	4	3	3	3	6	6	6	--	--	--	--
电压 Voltage	6.3	10	16	25	35	50	63	80	100	160	250	350	400	450	500																																		
Z-25℃/Z20℃	7	4	3	2	2	2	2	2	3	3	3	6	6	6	6																																		
Z-40℃/Z20℃	15	10	8	6	4	3	3	3	6	6	6	--	--	--	--																																		
<p>3.2、高温特性 High Temperature characteristics</p>	<p>◎依据 EIAJ 5141,5102 ◎将电容器存放在各系列额定温度 85℃和 105℃±3℃空气循环式恒温箱中，测定其参数应满足以下要求： ◎静电容量变化率：初始值±10%以内 ◎损耗变化率：规格值以内 ◎漏电流变化率：规格值以内 ◎外观：无明显异常 ◎Measured in Accordance With EIAJ 5141,5102 ◎capacitor at -85℃ or -105℃.120Hz the following specifications shall be satisfied ◎Capacitor change:≤within 10% of initial value ◎Dissipation Factor :initial specified value ◎Leakage current change:initial specified value ◎Appearance is good</p>																																																

<p>3.3、耐湿特性 Humidity resistance characteristics</p>	<p>◎依据 EIAJ 5141,5102 ◎将电容器存放在温度为 $40\pm 2^{\circ}\text{C}$、相对湿度为 90-95%RH 循环式恒温箱中，放置 120 ± 6 小时测定其参数应满足以下要求： ◎静电容量变化率：初始值$\pm 10\%$以内 ◎损耗变化率：规格值以内 ◎漏电流变化率：规格值以内 ◎外观：无明显异常 ◎Measured in Accordance With EIAJ 5141,5102 ◎The testing oven used in this test shall be capable of painting the temperature</p>								
<p>3.3、耐湿特性 Humidity resistance characteristics</p>	<p>At $40\pm 2^{\circ}\text{C}$ and relative humidity 90 to 95% for 120 ± 6 Hours.the following specifications shall be satisfied ◎Capacitor change:\leqwithin 10% of initial value ◎Dissipation Factor :initial specified value ◎Leakage current change:initial specified value ◎Appearance is good</p>								
<p>3.4、高温负荷寿命 High temperature Load life</p>	<p>◎依据 EIAJ 5141,5102 ◎将电容器加 $1\text{K}\Omega$ 电阻保护，然后加额定电压，置于标称温度 85°C 或 105°C，循环式恒温箱中，2000 小时后取出测试其参数应满足以下要求： ◎静电容量变化率：初始值$\pm 20\%$以内 ◎损耗变化率：规格值以内 ◎漏电流变化率：规格值以内 ◎外观：无明显异常 ◎Measured in Accordance With EIAJ 5141,5102 ◎DC Voltage shall be applied through 2000Ohms series resistor in such a manner as To develop rated Voltage across the capacitors are restored to 25°C after the rated Voltage applied at 85°C or $105^{\circ}\text{C}\pm 2^{\circ}\text{C}$ ◎Capacitor change:\leqwithin 20% of initial value ◎Dissipation Factor :initial specified value ◎Leakage current change:initial specified value ◎Appearance is good</p>								
<p>3.5、纹波电流频率因子 Ripple current frequency coefficient</p>		<p>频率 HZ Frequency</p>	50	120	300	1k	10k	100k	
		0.47-4.7uF	0.65	1.00	1.35	1.75	2.30	2.5	
		10-68uF	0.75	1.00	1.25	1.50	1.75	1.80	
		100-1000uF	0.8	1.00	1.15	1.30	1.40	1.50	
		2200-10000uF	0.85	1.00	1.03	1.0	1.08	1.08	
<p>3.6、高温无负荷寿命 High temperature Unload life</p>	<p>◎依据 EIAJ 5141,5102 ◎将电容器放置于额定 85°C 或 105°C 的循环式恒温箱中（不加电压），放置 1000 ± 12 小时后取出，待产品回复常温，测量其参数应满足以下要求： ◎静电容量变化率：初始值$\pm 20\%$以内 ◎损耗变化率：规格值以内 ◎漏电流变化率：规格值 200%以内 ◎外观：无明显异常 ◎Measured in Accordance With EIAJ 5141,5102 ◎The following specification shall be satisfied. When the capacitors are restored to 20°C.after exposing then at 85°C or 105°C for 1000 ± 12 Hours without voltage applied ◎Capacitor change:\leqwithin 20% of initial value ◎Dissipation Factor :initial specified value ◎Leakage current change:initial of 200% specified value ◎Appearance is good</p>								

加工型式 Forming Lead Type

1.1 编带 Taping

- Straight lead type
- PIN Code : X
- $\Phi D=4\sim 5$

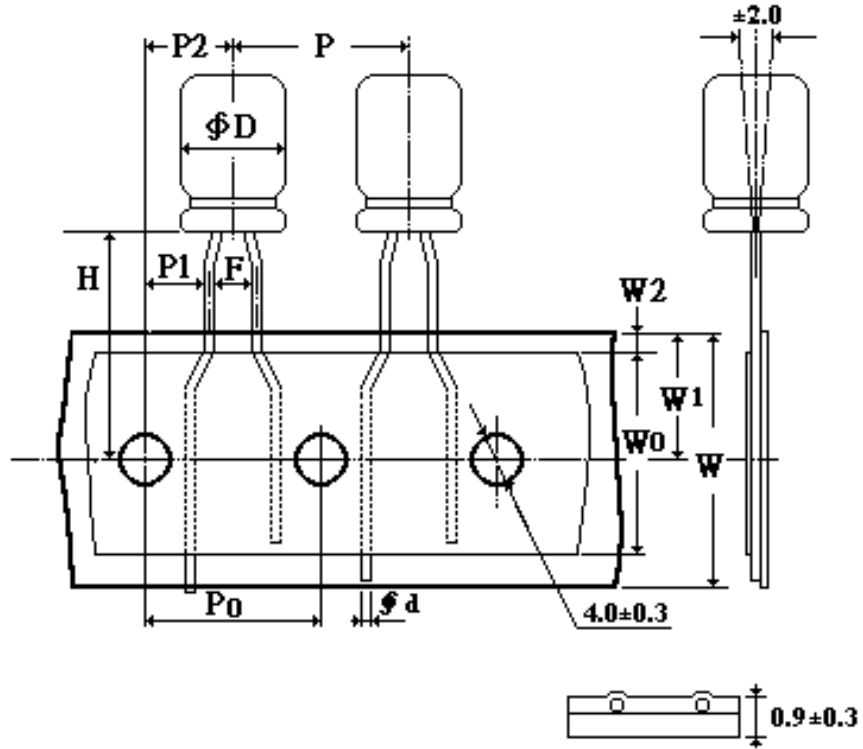

- PIN Code : B
- $\Phi D=4\sim 8$

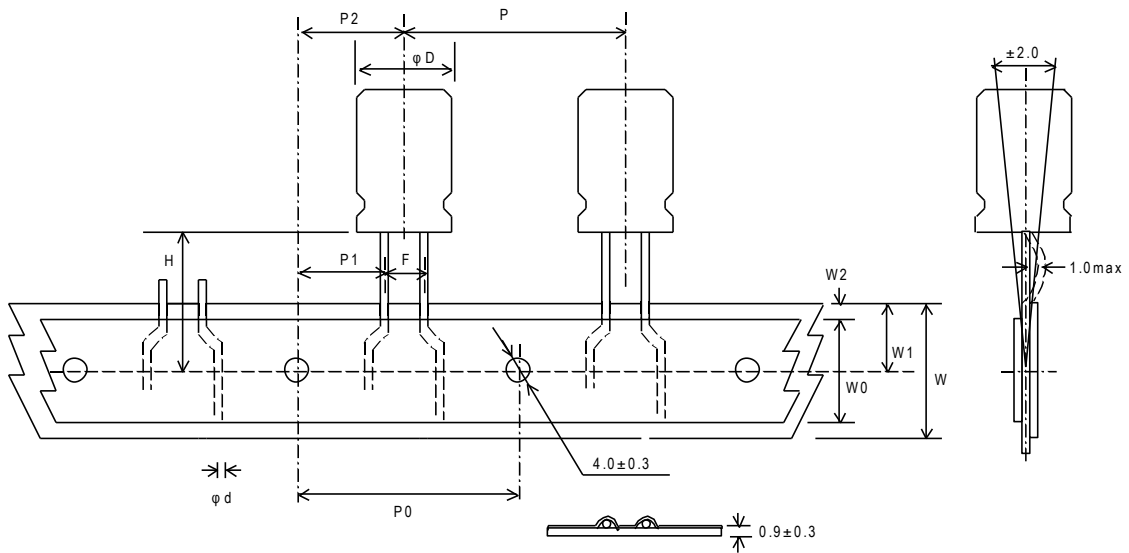

PIN Code : B
 $\Phi D=10$

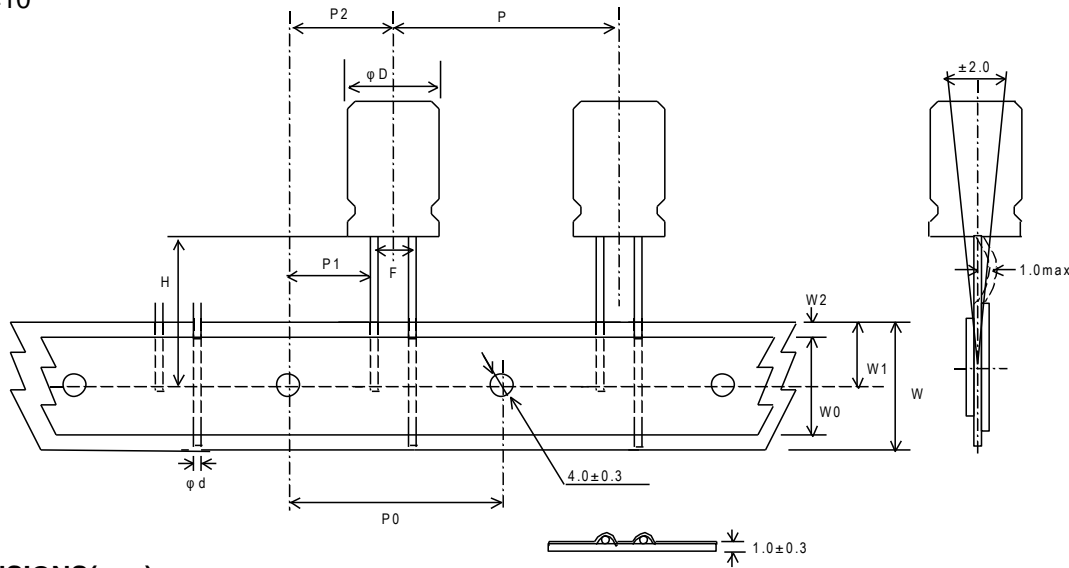

DIMENSIONS(mm)

Items	Symbol	CASE SIZE										Tolerance		
		4x5 4x7		5x5 5x7		5x11		6.3x5	6.3x7	6.3x11	8x5 8x7 8x11.5		8x16 8x20	10x12.5 10x16 10x20 10x23
Pin Code		X	B	X	B	X	B	B	B	B	B	B	B	
Lead wire diameter	Φd	0.45		0.45		0.5		0.45	0.5	0.5	0.45/0.5	0.6	0.6	± 0.05
Pitch of body	P	12.7		12.7		12.7		12.7	12.7	12.7	12.7	12.7	12.7	± 1.0
Feed hole pitch	P0	12.7		12.7		12.7		12.7	12.7	12.7	12.7	12.7	12.7	± 0.2
Hole center to lead distance	P1	4.35		4.35		4.35		4.35	4.35	4.35	4.35	4.35	3.85	± 0.7
Feed hole center to body center distance	P2	6.35		6.35		6.35		6.35	6.35	6.35	6.35	6.35	6.35	± 1.0
Lead to lead distance	F	2.5	1.5	2.5	2.0	2.5	2.0	2.5	2.5	2.5	3.5	3.5	5.0	± 0.5
Height of body from tape center	H	18.5		18.5		18.5		18.5	18.5	18.5	18.5	18.5	18.5	± 0.75
Base tape width	W	18.0		18.0		18.0		18.0	18.0	18.0	18.0	18.0	18.0	± 0.5
Adhesive tape width	W0	12.5		12.5		12.5		12.5	12.5	12.5	12.5	12.5	12.5	min
Hole position	W1	9.0		9.0		9.0		9.0	9.0	9.0	9.0	9.0	9.0	+0.75 -0.5
Hole down tape position	W2	3.0		3.0		3.0		3.0	3.0	3.0	3.0	3.0	3.0	max

● Forming type
 PIN Code : P
 $\Phi D=4\sim 8$

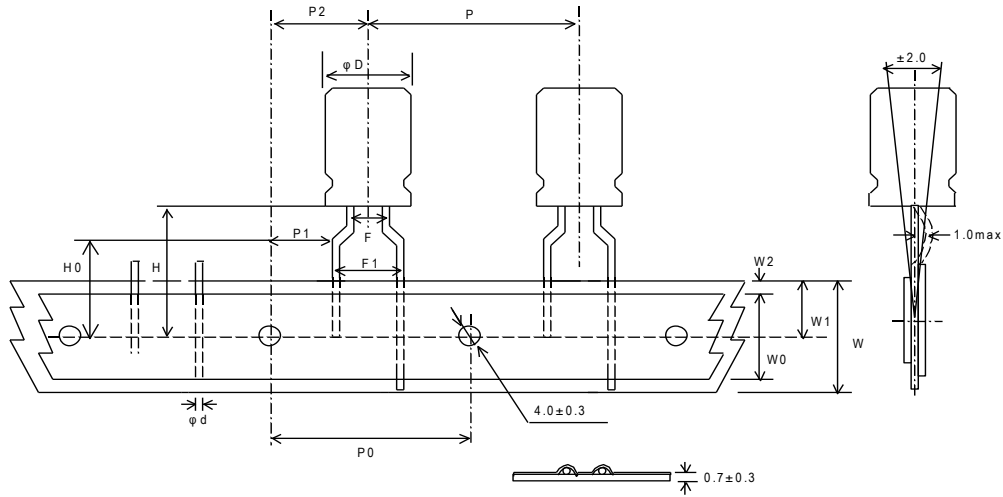

DIMENSIONS(mm)

Items	Symbol	CASE SIZE									Tolerance
		4x5 4x7	5x5	5x7	5x11	6.3x5	6.3x7	6.3x11	8x5 8x7 8x11.5	8x16 8x20	
Pin Code		P	P	P	P	P	P	P	P	P	
Lead wire diameter	Φd	0.45	0.45	0.45	0.5	0.45	0.5	0.5	0.45/0.5	0.6	± 0.05
Pitch of body	P	12.7	12.7	12.7	12.7	12.7	12.7	12.7	12.7	12.7	± 1.0
Feed hole pitch	P0	12.7	12.7	12.7	12.7	12.7	12.7	12.7	12.7	12.7	± 0.2
Hole center to lead distance	P1	3.85	3.85	3.85	3.85	3.85	3.85	3.85	3.85	3.85	± 0.7
Feed hole center to body center distance	P2	6.35	6.35	6.35	6.35	6.35	6.35	6.35	6.35	6.35	± 1.0
Lead to lead distance	F	1.5	2.0	2.0	2.0	2.5	2.5	2.5	3.5	3.5	± 0.5
Lead to lead distance	F1	5.0	5.0	5.0	5.0	5.0	5.0	5.0	5.0	5.0	+0.8 -0.2
Height of body from tape center	H	18.5	18.5	18.5	18.5	18.5	18.5	18.5	18.5	18.5	± 0.75
Lead wire clinch height	H0	16.0	16.0	16.0	16.0	16.0	16.0	16.0	16.0	16.0	± 0.5
Base tape width	W	18.0	18.0	18.0	18.0	18.0	18.0	18.0	18.0	18.0	± 0.5
Adhesive tape width	W0	12.5	12.5	12.5	12.5	12.5	12.5	12.5	12.5	12.5	min
Hole position	W1	9.0	9.0	9.0	9.0	9.0	9.0	9.0	9.0	9.0	+0.75 -0.5
Hole down tape position	W2	3.0	3.0	3.0	3.0	3.0	3.0	3.0	3.0	3.0	max

1.2 端子切脚或成型 Lead Cut& Lead Forming

- LEAD CUT
PIN CODE: C
RANGE: $\Phi 4\sim\Phi 18$

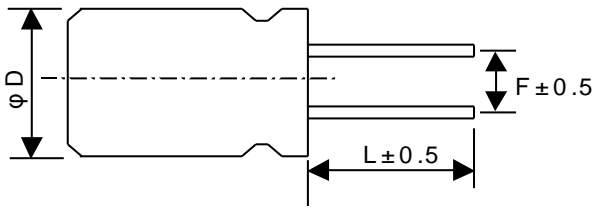

- LEAD FORMING AND CUT
PIN CODE: F
RANGE: $\Phi 4\sim\Phi 8$

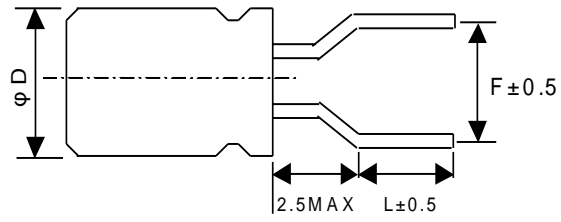

ΦD	F	L	ΦD	F	L
4	1.5	3.0~12.0	4	5.0	3.5, 4.5, 5.0, 7.0
5	2.0	3.0~12.0	5	5.0	3.5, 4.5, 5.0, 7.0
6.3	2.5	3.0~12.0	6.3	5.0	3.5, 4.5, 5.0, 7.0
8	3.5	3.0~12.0	8	5.0	3.5, 4.5, 5.0, 7.0
10	5.0	3.0~12.0	-	-	-
12.5	5.0	3.0~12.0	-	-	-
16	7.5	3.0~12.0	-	-	-
18	7.5	3.0~12.0	-	-	-

- Kink & cutting
PIN CODE: J
RANGE: $\Phi 10\sim\Phi 18$

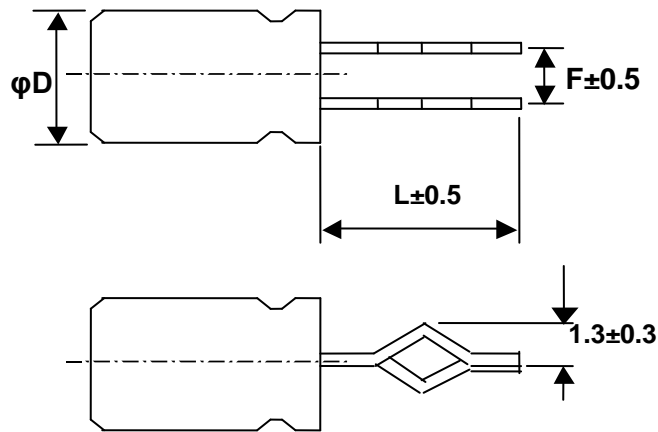

ΦD	F	L
10	5.0	3.6, 4.0, 4.5, 5.0
12.5	5.0	3.6, 4.0, 4.5, 5.0
16	7.5	3.6, 4.0, 4.5, 5.0
18	7.5	3.6, 4.0, 4.5, 5.0

波峰焊接

1.1曲线要求:

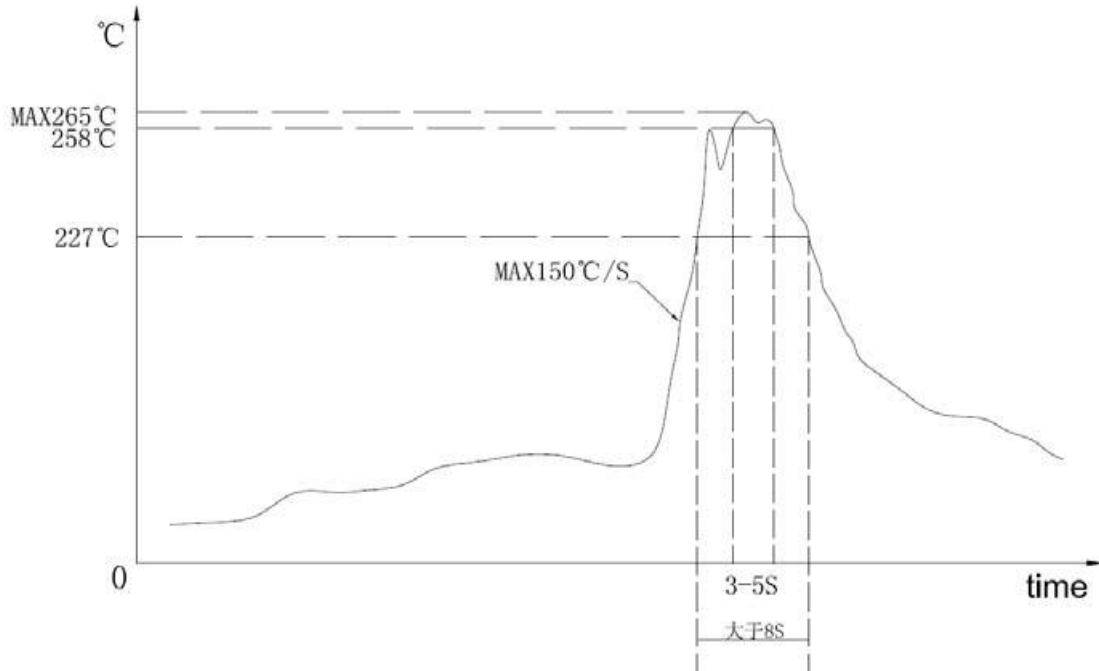

1.2物料要求:

- A) 焊接最高温度为265°C，物料最大承受温度应满足在265°C 5S 的焊接时间；
- B) 元件引脚能承受150 °C/S的热冲击, 且能循环2次以上。
- C) 插件元器件的本体塑封（塑胶部分）必须在60-90秒内耐120 °C高温。
- D) 能保证在227°C-265°C承受8S 连续焊接时间，258°C-265°C 5S的焊接时间。
- E) 插装物料手工焊接保证在温度设置390 °C时，8秒的焊接时间

铝电解电容 物质成份表 Aluminum electrolytic capacitors composition List

材料名称 MATERIALS		材料成份表 COMPOSITION OF MATERIALS	含量百分比	供应商
铝箔 ALUMINUM FOL	铝 AL		99.98%	众和、海星、宏远、飞乐、华锋、
	三氧化二铝 Al_2O_3		0.02%	
电解纸 PAPER	纸纤维素 CELLULOSE		100%	鲁南、凯恩
电解液 ELECTROLYTE	乙二醇 ETHYL GLYCL		50%	鸿崑、久制
	乙二酸铵 AMMONIUM ADIPATE		机密	
	乙二酸 ADIPIC ACID		机密	
	安息香酸铵 AMMOUIUN BENZOATE		机密	
	柠檬酸 CITRIC ACID		机密	
	对硝基安息香醇 PARA-NITORO BENZOIE ACID		机密	
	磷酸二氧氨 AMMDIHYDROGEN PHOSPHLATE		机密	
	纯水、甲酸铵 PURE WATER、AMMONIUM ACETATE		机密	
导针 LEAD WIRE	铝线 AL-WIRE	铝 AL	99.91%	金江、益利达
		硅 Si	0.03%	
		铁 Fe	0.05%	
		铜 Cu	0.01%	
	镀锡铜包钢线 TIN PLATED COPPER COVERED SLEEL WIRE	铁 Fe	71.35%	
		铜 Cu	20%	
		锡 Sn	8.65%	
胶粒 PUBBER	三元乙丙胶 EPDM		40%	玉环 科实达
	白土 CLAY		45%	
	碳烟 CARBON		9.00%	
	其它 OTHER		6.00%	
铝壳 AL-CASE	铝 AL		99.30%	宏信 大铭 奥星
	铜 Cu		0.20%	
	锰 Mn		0.20%	
	锌 Zn		0.20%	
	其它 OTHER		0.10%	
套管 SLEEVE TUBE	PET 聚对苯二甲酸乙二醇 POLYETHYLENE TEREPHTHALATE PET		90%	云林 弘泰 丰塑
	稳定剂 STABILILER		0.20%	
	润滑剂 LUBRICANT 颜料 PIGMENT 强韧剂 TOUGHENER		0.15% 1.00% 8.65%	

11. 其它说明

11. 1 铝电解电容器使用注意事项 IMPORTANT INFORMATION ON THE APPLICATION OF ALUMINUM ELECTROLYTIC CAPACITORS

(1). 直流铝电解电容器应按正确的极性使用 DC electrolytic capacitors are polarized

当直流铝电解电容器按反极性接入电路时，电容器会导致电子线路短路，由此产生的电流会引致电容器损坏。若电路中有可能在负引线施加正极电压，请选无极性产品。

When reverse voltage is applied on DC electrolytic capacitor, the capacitor will becomes short circuited please use no polarized capacitors in the circuit be damage due to abnormal current flows through the capacitors since the circuit where the positive voltage may be applied to the cathode terminal.

(2). 在额定工作电压以下作用 Use capacitor within rated voltage

当电容器上所施加电压高于额定工作电压时，电容器的漏电流将上升，其电气特性将在短时期内劣化直至损坏。请注意电压峰值勿超出额定工作电压。

When capacitor is used at higher voltage than the rated voltage, leakage current increases, characteristics drastically deteriorate and damage in a short period may occur as a result. Please take extra caution that the peak voltage should not exceed the rated voltage.

(3). 作快速充放电使用 Charge and discharge application.

当常规电容器被用作快速充电用途。其使用寿命可能会因为容量下降，温度急剧上升等而缩减

When aluminum electrolytic capacitors for general purpose are employed in rapid charge and discharge application, its life expectancy may be short end by capacitance decrease, heat rise, etc.

(4). 电容器贮存 Store the capacitor.

当铝电解电容器作了长期贮存后，其漏电流通常升高，贮存温度愈高，漏电流上升愈快。因此应注意贮存环境的选择，在电容器上施加电压后，漏电流值将不断下降，在铝电解电容器的漏电流值上升对电路有不良影响的，请在使用前充电处理。

Increased leakage current is common in aluminum capacitors which have been stored for long period of time. The Higher the storage temperature, the higher the leakage current increase, therefore please take precautions concerning the storage location. The leakage current decreases gradually as voltage is applied to the capacitor. In cases where increased leakage current causes problems in the circuit, apply voltage(aging) before using.

(5). 施加纹波电流应小于额定值 Ripple current applied to capacitor should not exceed the rated value.

施加纹波电流超过额定值后，会导致电容器体过热，容量下降，寿命缩短。所施加纹波电压的峰值应小于额定工作电压。Excessive heat will reduce capacitance and result in shortened life of capacitor if ripple currents exceeding the specified rated value are applied. The peak value of the ripple voltage should be less than the rated voltage.

(6). 使用环境温度 Ambient temperature.

铝电解电容器的使用寿命会受到环境温度的影响。据科学统计，使用环境温度下降 10℃其使用寿命增加 1 倍。

Life of the aluminum electrolytic capacitor is affected by the ambient temperature. It is generally stated, that life doubles for each 10°C decrease in temperature.

(7). 引出线强度 Lead stress

当拉力施加到电容器引出线，该拉力将作用于电容器内部，这将导致电容器内部短路，开路或漏电流上升。在电容器焊装到电路板，请勿强烈摇动电容器。

When a strong force is applied to the lead wires or terminals, stress is put on the internal connections. This may result in short circuit, open circuit or increased leakage current. It is not advisable to bend or handle a capacitor after it has been soldered to the PC board.

(8). 焊接过程耐热性 Heat resistance at the soldering process

铝电解电容器装至电路板进行浸焊或波焊时，其塑料套管可能因焊接时间过长、温度过高而发生破裂或二次收缩。

In the dip soldering process of PC board with aluminum electrolytic capacitors mounted, secondary shrinkage or crack of PVC sleeve may be observed when solder temperature is too high or dipping time is too long.

(9). 电路板的安装孔孔距及安装位置 Hole pitch and position of PC board.

电路板安装孔的设计应与产品说明书的引线脚距相一致，如果将电容器强行插入孔距不配套的电路板，那么会有应力作用于引出线，这将导致短路或漏电流上升。

A PC board must be designed so its hole pitch coincides with the lead pitch(lead spacing) of the capacitor specified by the catalog or specifications. when a capacitors is forcibly inserted into an unmatched hole pitch, a stress is put on the leads This could result in a short circuit or increased leakage current.

11. 2 符合 RoHS EU/RoHS

本产品（包括所有构件）完全符合欧盟 RoHS 要求，即 6 种有害物质的最大含量均不超过如下要求：

We product is according to the standard of ROHS , it means the max capacitance of six harmful material not over the following request

Cd (镉) - 100PPM	Pb (铅) -1000PPM	Hg (汞) -1000PPM
Cr ⁺⁶ (6 价铬) -1000PPM	PBBs (多溴联苯) -1000PPM	PBDEs (多溴联苯醚) -1000PPM