

**600mA, 1.5MHz Synchronous Step-Down Converter**

The SD8906A is a constant frequency, current mode PWM step-down converter. The device integrates a main switch and a synchronous rectifier for high efficiency without an external Schottky diode. It is ideal for powering portable equipment that runs from a single cell Lithium-Ion (Li+) battery. The output voltage can be regulated as low as 0.6V. The SD8906A can also run at 100% duty cycle for low dropout operation, extending battery life in portable system. This device offers two operation modes, PWM control and PFM Mode switching control, which allows a high efficiency over the wider range of the load.

The SD8906A is offered in a low profile (1mm) 5-pin, thin SOT package, and is available in an adjustable version and fixed output voltage of 1.2V, 1.5V, 1.8V, 2.5V and 3.3V.

**FEATURES**

- High Efficiency: Up to 96%
- 1.5MHz Constant Frequency Operation
- 600mA Output Current
- No Schottky Diode Required
- 2.3V to 5.5V Input Voltage Range
- Short Circuit Protection
- <math>1\mu\text{A}</math> Shutdown Current
- Tiny SOT23-5 Package
- Output Voltage as Low as 0.6V
- 100% Duty Cycle in Dropout
- Low Quiescent Current: 35 $\mu\text{A}$
- Slope Compensated Current Mode Control for Excellent Line and Load Transient Response
- Thermal Fault Protection
- Inrush Current Limit and Soft Start

**APPLICATIONS**

- Digital Still and Video Cameras
- Wireless and DSL Modems
- PDAs
- MP3 Players
- Cellular and Smart Phones

**Typical Application**

Figure 1. Basic Application Circuit



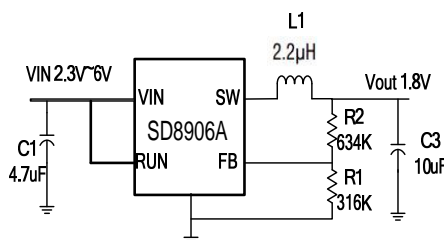
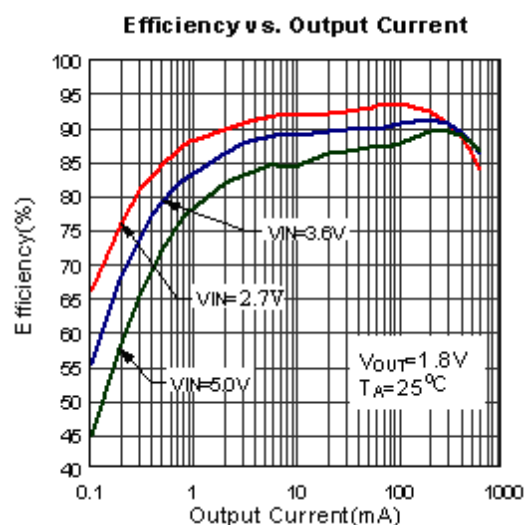

### Absolute Maximum Ratings (Note 1)

Lead Temperature(Soldering,10s) .....+300°C    Peak SW Sink and Source Current...1.8A  
 SW Voltage .....3V to (Vin+0.3V)    Storage Temperature Range .....-65°C to 150°C  
 Input Supply Voltage ..... -0.3V to 7V    Operating Temperature Range ... -40°C to +85°C  
 RUN,VOUT Voltages..... -0.3V to 7V    Junction Temperature(Note2) .....125°C

### Package/Order Information

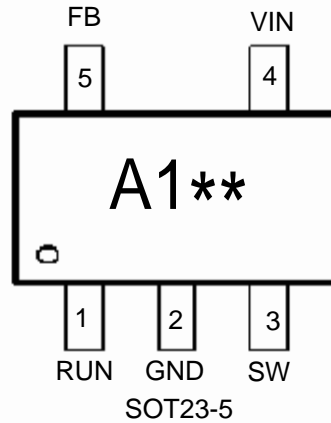

Part Number	OUTPUT VOLTAGE (V)	OUTPUT CURRENT (A)	SWICHING FREQUENCY	Temp Range
SD8906A	ADJ	0.6	1.5MHz	-40°C to +85°C

### Pin Description

PIN	NAME	FUNCTION
1	RUN	Chip Enable Pin. Drive RUN above 1.5V to turn on the part. Drive RUN below 0.3V to turn it off. Do not leave RUN floating.
2	GND	Ground Pin
3	SW	Power Switch Output. It is the switch node connection to Inductor. This pin connects to the drains of the internal P-ch and N-ch MOSFET switches.
4	VIN	Power Supply Input. Must be closely decoupled to GND, Pin 2, with a 4.7µF or greater ceramic capacitor.
5	VOUT	Output Voltage Feedback Pin. An internal resistive divider divides the output voltage down for comparison to the internal reference voltage.

**Electrical Characteristics** (Note 3)(V<sub>IN</sub>=V<sub>RUN</sub>=3.6V, V<sub>OUT</sub>=1.8V, T<sub>A</sub> = 25°C, unless otherwise noted.)

Parameter	Conditions	MIN	TYP	MAX	unit
Input Voltage Range		2.7		6	V
UVLO Threshold		2.2	2.4	2.5	V
Input DC Supply Current	(Note 4)				μA
PWM Mode	V <sub>out</sub> = 90%, I <sub>load</sub> =0mA		200	400	μA
PFM Mode	V <sub>out</sub> = 105%, I <sub>load</sub> =0mA		20	35	μA
Shutdown Mode	V <sub>RUN</sub> = 0V, V <sub>IN</sub> =4.2V		0.1	1.0	μA
Regulated Feedback Voltage	T <sub>A</sub> = 25°C	0.588	0.600	0.612	V
	T <sub>A</sub> = 0°C ≤ T <sub>A</sub> ≤ 85°C	0.586	0.600	0.613	V
	T <sub>A</sub> = -40°C ≤ T <sub>A</sub> ≤ 85°C	0.585	0.600	0.615	V
Reference Voltage Line Regulation	V <sub>in</sub> =2.7V to 5.5V		0.04	0.40	%/V
Output Voltage Line Regulation	V <sub>IN</sub> = 2.7V to 5.5V		0.04	0.4	%
Output Voltage Load Regulation			0.5		%
Oscillation Frequency	V <sub>out</sub> =100%	1.3	1.5	1.8	MHz
	V <sub>out</sub> =0V		300		KHz
On Resistance of PMOS	I <sub>SW</sub> =100mA		0.4	0.45	Ω
ON Resistance of NMOS	I <sub>SW</sub> =-100mA		0.35	0.45	Ω
Peak Current Limit	V <sub>IN</sub> = 3V, V <sub>out</sub> =90%		1.5		A
RUN Threshold		0.30	1.0	1.50	V
RUN Leakage Current			±0.01	±1.0	μA
SW Leakage Current	V <sub>RUN</sub> =0V, V <sub>IN</sub> =V <sub>sw</sub> =5V		±0.01	±1.0	μA

**Note 1:** Absolute Maximum Ratings are those values beyond which the life of a device may be impaired.**Note 2:** T<sub>J</sub> is calculated from the ambient temperature T<sub>A</sub> and power dissipation P<sub>D</sub> according to the following formula:  $T_J = T_A + (P_D) \times (250^\circ\text{C/W})$ .**Note3:** 100% production test at +25°C. Specifications over the temperature range are guaranteed by design and characterization.**Note 4:** Dynamic supply current is higher due to the gate charge being delivered at the switching frequency



### Typical Performance Characteristics

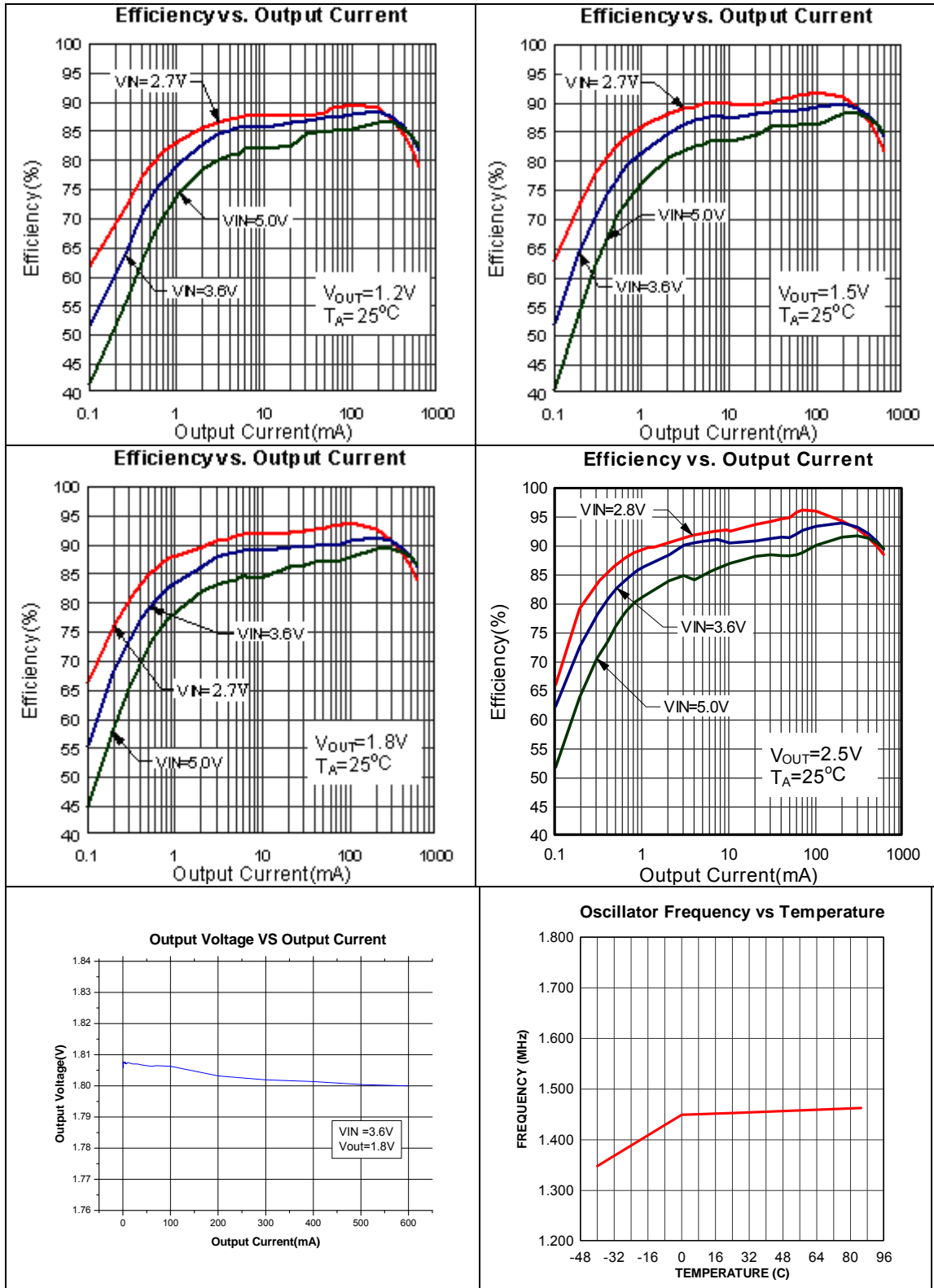

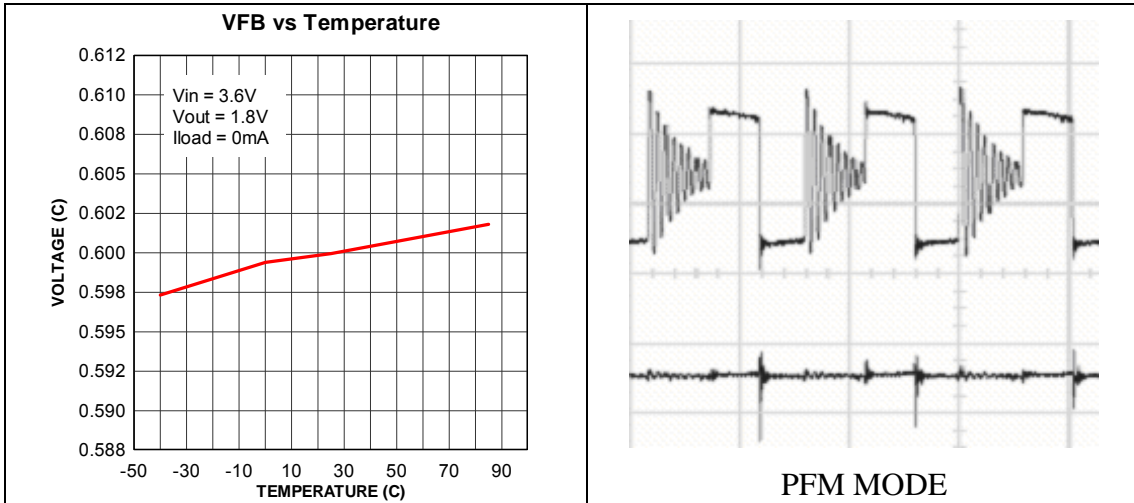
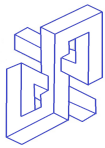

### Functional Block Diagram

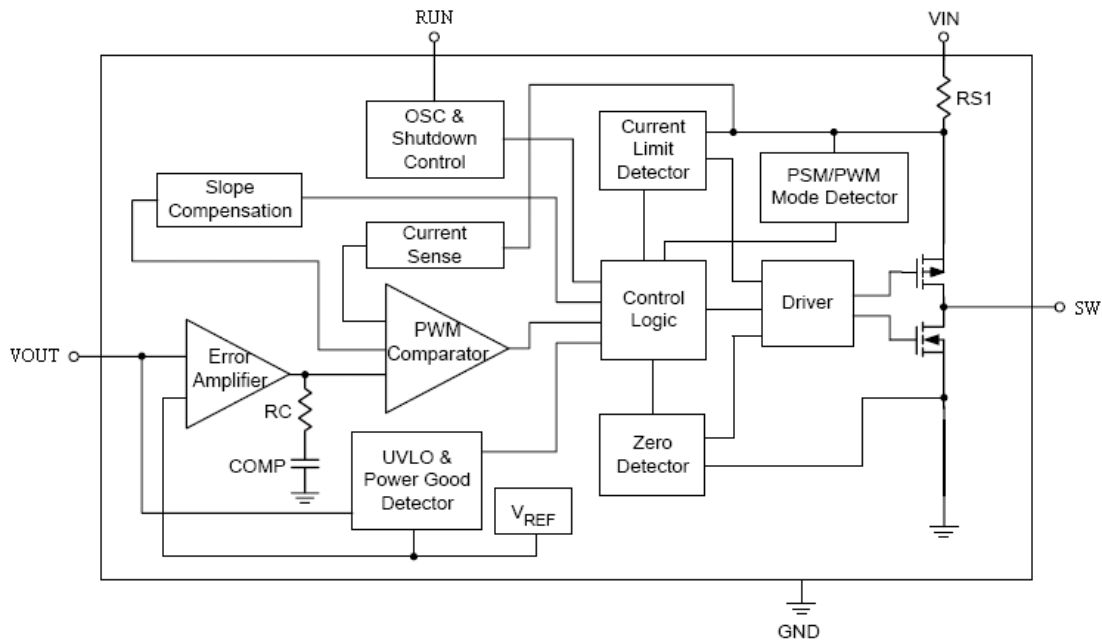

Figure 2. SD8906A Block Diagram



## Functional Description

The SD8906A is a high performance 600mA 1.5MHz monolithic step-down converter. The SD8906A requires only three external power components (C<sub>in</sub>, C<sub>out</sub> and L). The adjustable version can be programmed with external feedback to any voltage, ranging from 0.6V to the input voltage.

At dropout, the converter duty cycle increases to 100% and the output voltage tracks the input voltage minus the R<sub>dson</sub> drop of the high-side MOSFET.

The internal error amplifier and compensation provides excellent transient response, load, and line regulation. Soft start function prevents input inrush current and output overshoot during start up.

## APPLICATIONS INFORMATION

### Inductor Selection

For most designs, SD8906A operates with inductors of 1μH to 4.7μH. Low inductance values are physically smaller but require faster switching, which results in some efficiency loss. The inductor value can be derived from the following equation:

$$L = \frac{V_{OUT} \times (V_{IN} - V_{OUT})}{V_{IN} \times \Delta I_L \times f_{OSC}}$$

Where  $\Delta I_L$  is inductor Ripple Current.

Large value inductors result in lower ripple current and small value inductors result in high ripple current. For optimum voltage-positioning load transients, choose an inductor with DC series resistance in the 50mΩ to 150mΩ range.

### Input Capacitor Selection

The input capacitor reduces the surge current drawn from the input and switching noise from the device. The input capacitor impedance at the switching frequency should be less than input source impedance to prevent high frequency switching current passing to the input. A low ESR input capacitor sized for maximum RMS current must be used. Ceramic capacitors with X5R or X7R dielectrics are highly recommended because of their low ESR and small temperature coefficients. A 4.7μF ceramic capacitor for most applications is sufficient. A large value may be used for improved input voltage filtering.

### Output Capacitor Selection

The output capacitor is required to keep the output voltage ripple small and to ensure regulation loop stability. The output capacitor must have low impedance at the switching frequency. Ceramic capacitors with X5R or X7R dielectrics are recommended due to their low ESR and high ripple current ratings. The output ripple V<sub>OUT</sub> is determined by:

$$\Delta V_{OUT} \leq \frac{V_{OUT} \times (V_{IN} - V_{OUT})}{V_{IN} \times f_{OSC} \times L} \times \left( ESR + \frac{1}{8 \times f_{osc} \times C3} \right)$$

A 10μF ceramic can satisfy most applications.

### PC Board Layout Checklist

When laying out the printed circuit board, the following checking should be used to ensure proper operation of SD8906A. Check the following in your layout:

1. The power traces, consisting of the GND trace, the SW trace and the VIN trace should be kept short, direct and wide.
2. Does the (+) plates of C<sub>in</sub> connect to Vin as closely as possible? This capacitor provides the AC current to the internal power MOSFETs.
3. Keep the switching node, SW, away from the sensitive VOUT node.
4. Keep the (-) plates of C<sub>in</sub> and C<sub>out</sub> as close as possible

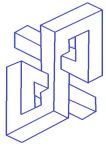

### Package Description

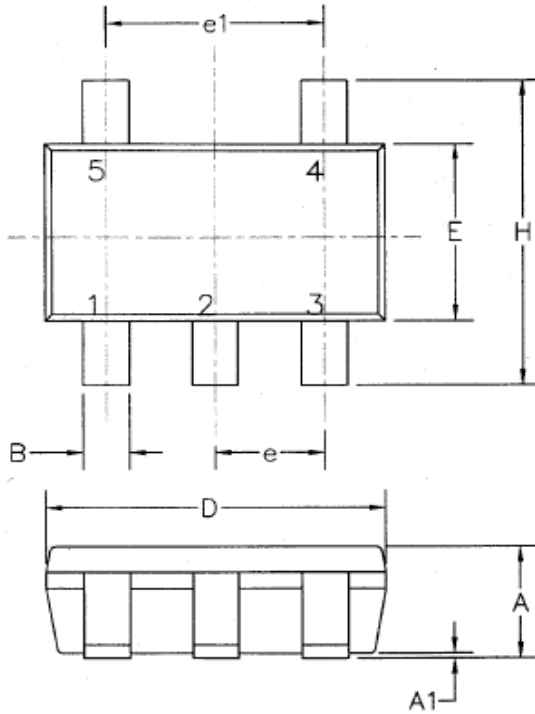

5LD SOT-23 PACKAGE OUTLINE DIMENSIONS  
ALL DIMENSIONS IN MM.

Dimension	Min.	Max.
A	0.9	1.10
A1	0.01	0.13
B	0.3	0.5
C	0.09	0.2
D	2.8	3.0
H	2.5	3.1
E	1.5	1.7
e	0.95 REF.	
e1	1.90 REF.	
L1	0.2	0.55
L	0.35	0.8
Q	0°	10°

