

N-Channel Super Junction Power MOSFET

Features

- New technology for high voltage device
- Low on-resistance and low conduction losses
- Small package
- Ultra Low Gate Charge cause lower driving requirements
- 100% Avalanche Tested
- ROHS compliant

Application

- Power factor correction (PFC)
- Switched mode power supplies(SMPS)
- Uninterruptible Power Supply (UPS)

V_{DS}	650	V
$R_{DS(ON) MAX}$	180	mΩ
I_D	21	A

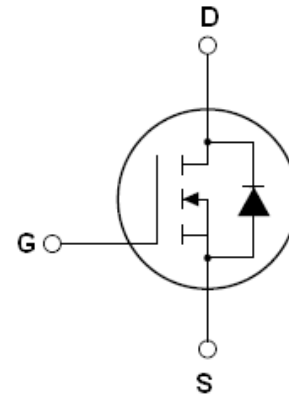

Schematic diagram

Package Marking And Ordering Information

Device	Device Package	Marking
SL21N65CK	TO-263	SL21N65CK
SL21N65C	TO-220	SL21N65C
SL21N65CF	TO-220F	SL21N65CF

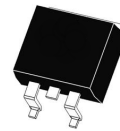

TO-263

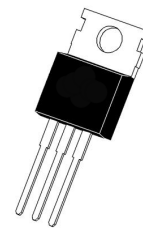

TO-220

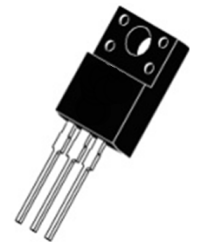

TO-220F

Table 1. Absolute Maximum Ratings ($T_C=25^\circ\text{C}$)

Parameter	Symbol	SL21N65CK SL21N65C	SL21N65CF	Unit
Drain-Source Voltage ($V_{GS}=0V$)	V_{DS}	650		V
Gate-Source Voltage ($V_{DS}=0V$), AC ($f>1\text{ Hz}$)	V_{GS}	± 30		V
Continuous Drain Current at $T_C=25^\circ\text{C}$	$I_{D(DC)}$	21	21*	A
Continuous Drain Current at $T_C=100^\circ\text{C}$	$I_{D(DC)}$	13.2	13.2*	A
Pulsed drain current (Note 1)	$I_{DM(pluse)}$	84	84*	A
Maximum Power Dissipation($T_C=25^\circ\text{C}$)	P_D	188	33.8	W
Derate above 25°C		1.5	0.27	W/ $^\circ\text{C}$
Single pulse avalanche energy (Note 2)	E_{AS}	441		mJ
Avalanche current (Note 1)	I_{AR}	10.5		A
Repetitive Avalanche energy, t_{AR} limited by T_{Jmax} (Note 1)	E_{AR}	0.7		mJ

Parameter	Symbol	SL21N65CK SL21N65C	SL21N65CF	Unit
Drain Source voltage slope, $V_{DS} \leq 480$ V,	dv/dt	50		V/ns
Reverse diode dv/dt, $V_{DS} \leq 480$ V, $I_{SD} < I_D$	dv/dt	15		V/ns
Operating Junction and Storage Temperature Range	T_J, T_{STG}	-55...+150		°C

* limited by maximum junction temperature

Table 2. Thermal Characteristic

Parameter	Symbol	SL21N65CK SL21N65C	SL21N65CF	Unit
Thermal Resistance, Junction-to-Case (Maximum)	R_{thJC}	0.66	3.69	°C / W
Thermal Resistance, Junction-to-Ambient (Maximum)	R_{thJA}	62.5	80	°C / W

Table 3. Electrical Characteristics (TA=25°C unless otherwise noted)

Parameter	Symbol	Condition	Min	Typ	Max	Unit
On/off states						
Drain-Source Breakdown Voltage	BV_{DSS}	$V_{GS}=0V, I_D=250\mu A$	650			V
Zero Gate Voltage Drain Current($T_C=25^\circ C$)	I_{DSS}	$V_{DS}=650V, V_{GS}=0V$		0.05	1	μA
Zero Gate Voltage Drain Current($T_C=125^\circ C$)	I_{DSS}	$V_{DS}=650V, V_{GS}=0V$			100	μA
Gate-Body Leakage Current	I_{GSS}	$V_{GS}=\pm 20V, V_{DS}=0V$			± 100	nA
Gate Threshold Voltage	$V_{GS(th)}$	$V_{DS}=V_{GS}, I_D=250\mu A$	3	3.5	4	V
Drain-Source On-State Resistance	$R_{DS(ON)}$	$V_{GS}=10V, I_D=10.5A$		150	180	m Ω
Dynamic Characteristics						
Forward Transconductance	g_{FS}	$V_{DS} = 20V, I_D = 10.5A$		16		S
Input Capacitance	C_{ISS}	$V_{DS}=50V, V_{GS}=0V,$ $F=1.0MHz$		2250		PF
Output Capacitance	C_{OSS}			83		PF
Reverse Transfer Capacitance	C_{RSS}			1.6		PF
Total Gate Charge	Q_g	$V_{DS}=480V, I_D=21A,$ $V_{GS}=10V$		36		nC
Gate-Source Charge	Q_{gs}			14		nC
Gate-Drain Charge	Q_{gd}			8.5		nC
Switching times						
Turn-on Delay Time	$t_{d(on)}$	$V_{DD}=380V, I_D=11A,$ $R_G=4\Omega, V_{GS}=10V$		11		nS
Turn-on Rise Time	t_r			6		nS
Turn-Off Delay Time	$t_{d(off)}$			61		nS
Turn-Off Fall Time	t_f			4.5		nS
Source- Drain Diode Characteristics						
Source-drain current(Body Diode)	I_{SD}	$T_C=25^\circ C$			21	A
Pulsed Source-drain current(Body Diode)	I_{SDM}				84	A
Forward on voltage	V_{SD}	$T_J=25^\circ C, I_{SD}=21A, V_{GS}=0V$		0.9	1.3	V
Reverse Recovery Time	t_{rr}	$T_J=25^\circ C, I_F=21A, di/dt=100A/\mu s$		310		nS
Reverse Recovery Charge	Q_{rr}			5		μC
Peak Reverse Recovery Current	I_{rrm}			28		A

Notes 1. Repetitive Rating: Pulse width limited by maximum junction temperature

2. $T_J=25^\circ C, V_{DD}=50V, V_G=10V, R_G=25\Omega$

TYPICAL ELECTRICAL AND THERMAL CHARACTERISTICS (curves)

Figure1. Safe operating area for TO-220/TO-263

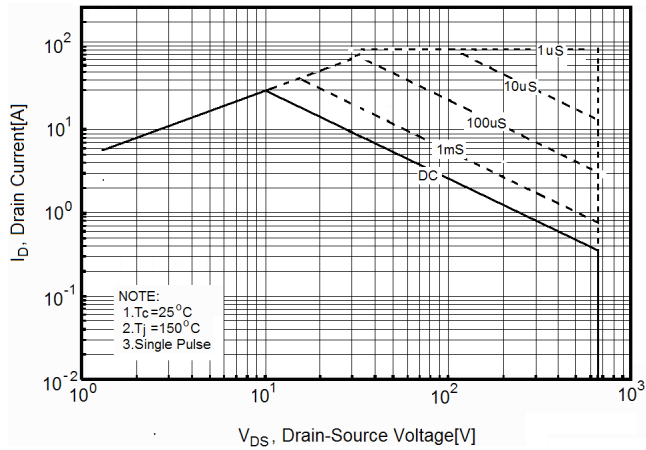

Figure2. Safe operating area for TO-220F

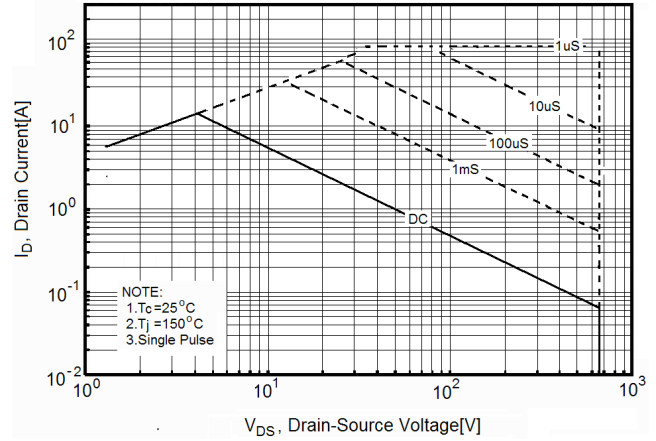

Figure3. Source-Drain Diode Forward Voltage

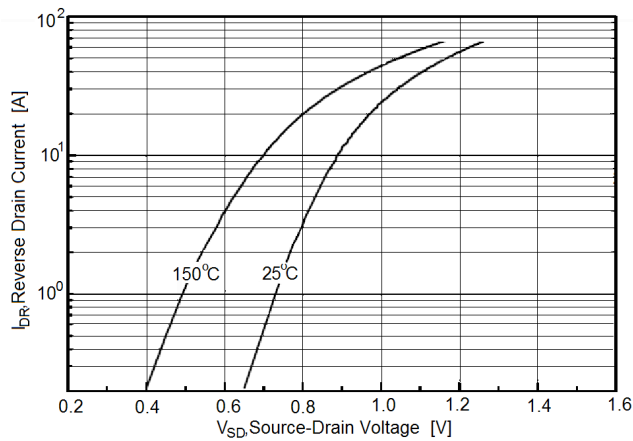

Figure4. Output characteristics

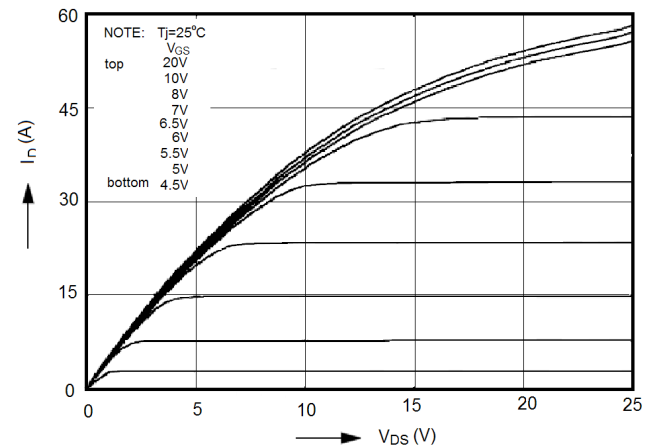

Figure5. Transfer characteristics

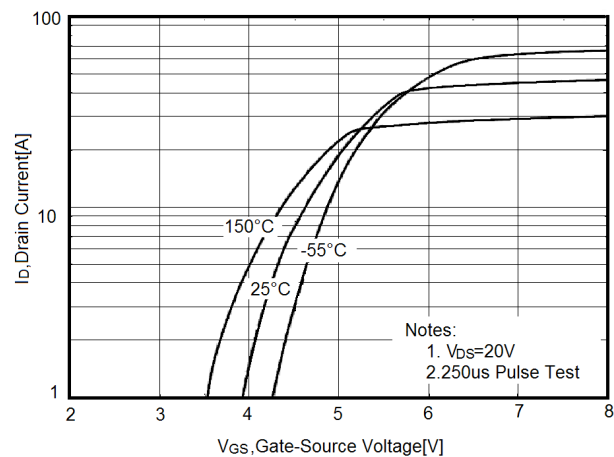

Figure6. Static drain-source on resistance

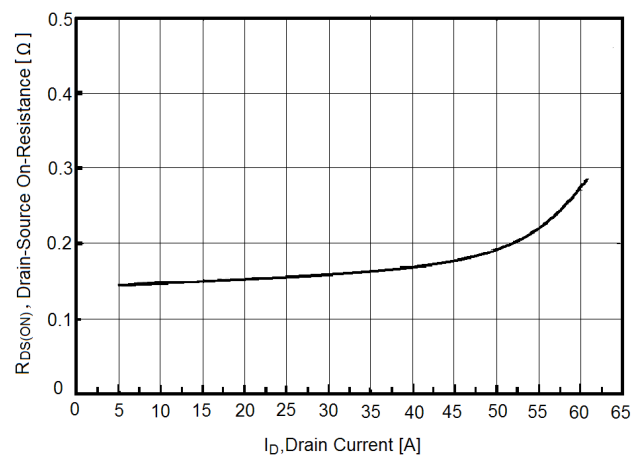

Figure7. $R_{DS(ON)}$ vs Junction Temperature

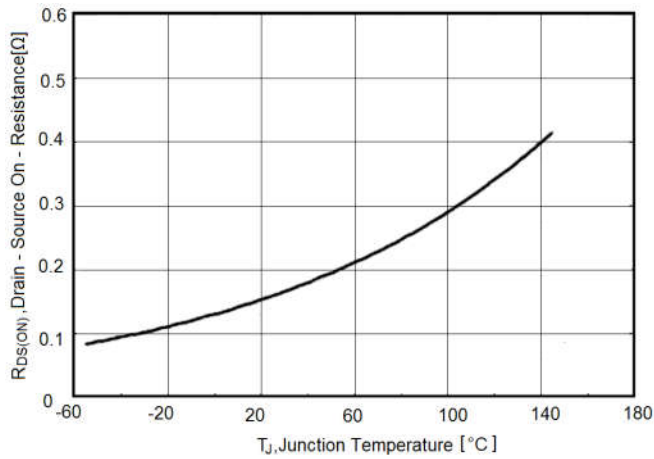

Figure8. BV_{DSS} vs Junction Temperature

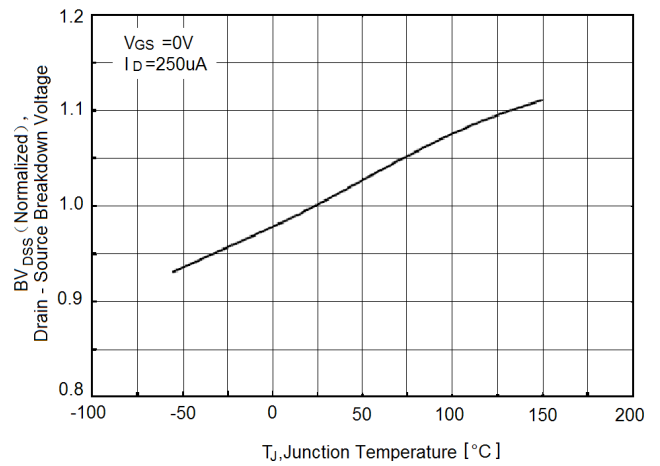

Figure9. Maximum I_D vs Junction Temperature

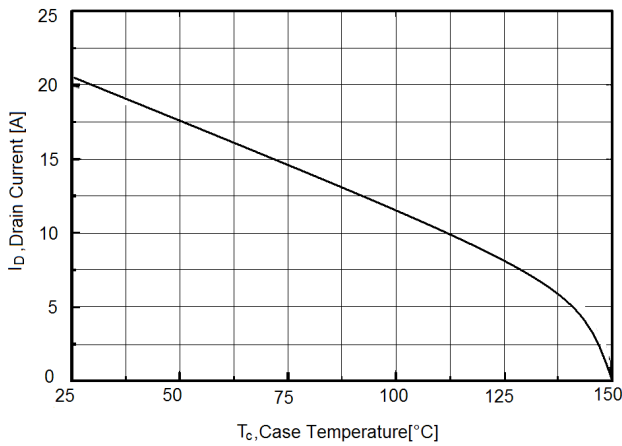

Figure10. Transient Thermal Impedance for TO-220

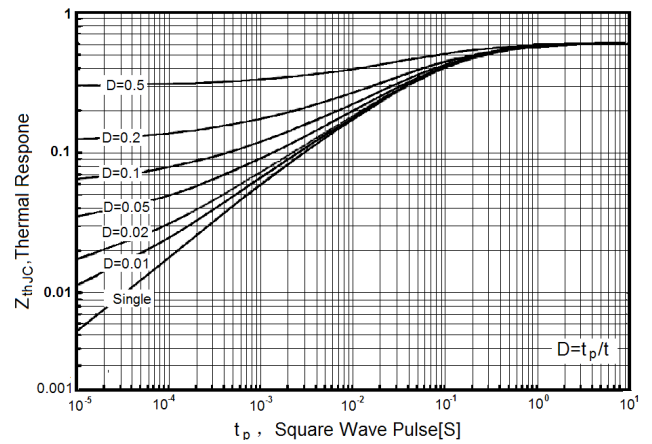

Figure11. Transient Thermal Impedance for TO-220F

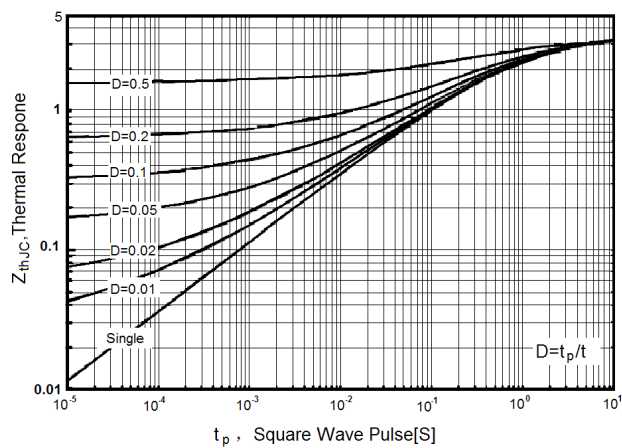

Figure12. Gate charge waveforms

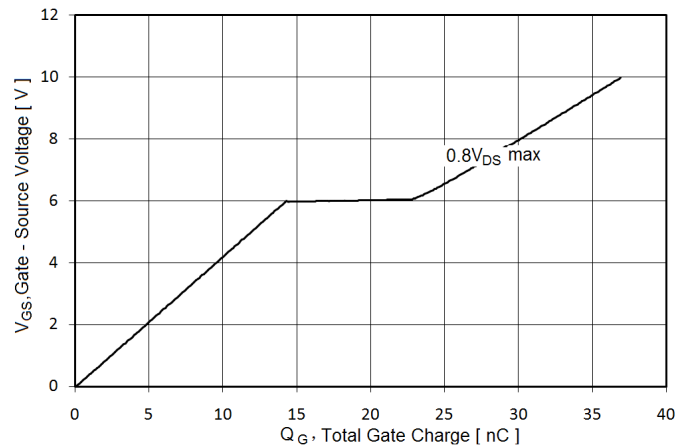
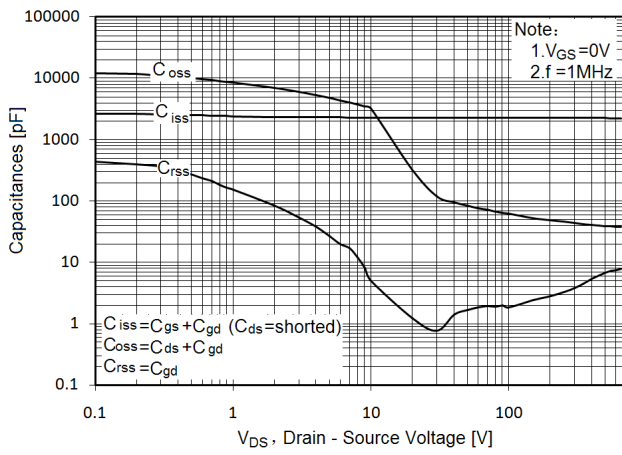
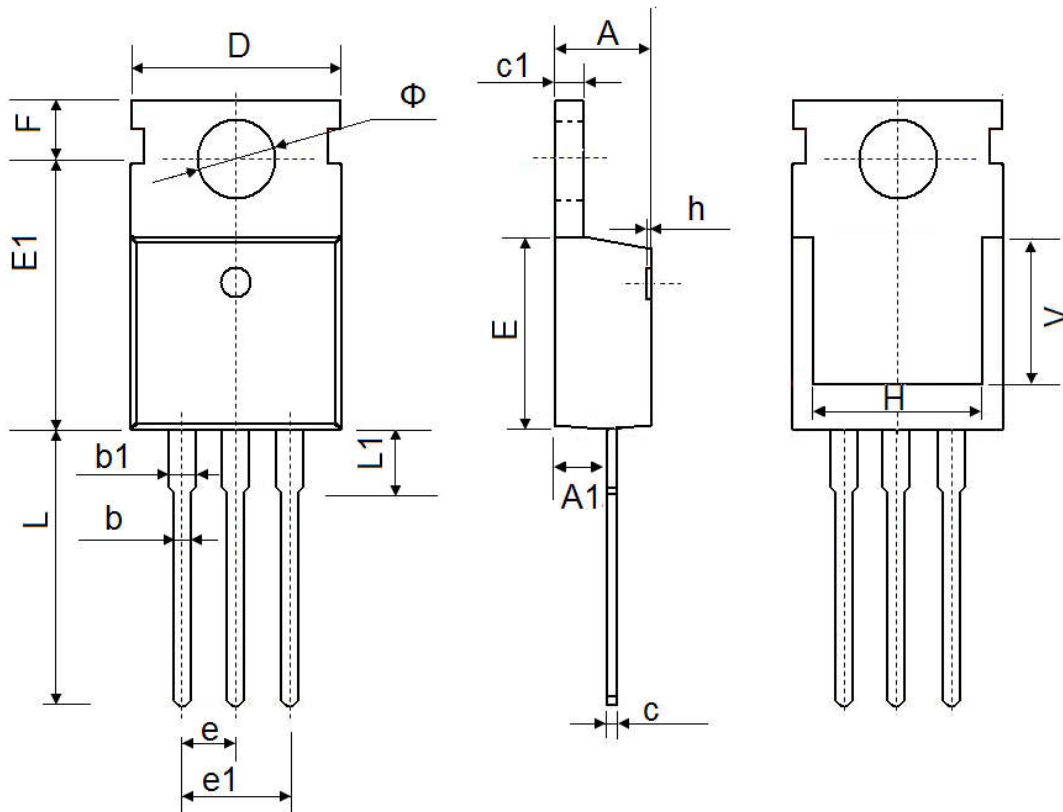

Figure13. Capacitance



TO-220-3L-C Package Information

Symbol	Dimensions In Millimeters		Dimensions In Inches	
	Min.	Max.	Min.	Max.
A	4.400	4.600	0.173	0.181
A1	2.250	2.550	0.089	0.100
b	0.710	0.910	0.028	0.036
b1	1.170	1.370	0.046	0.054
c	0.330	0.650	0.013	0.026
c1	1.200	1.400	0.047	0.055
D	9.910	10.250	0.390	0.404
E	8.9500	9.750	0.352	0.384
E1	12.650	12.950	0.498	0.510
e	2.540 TYP.		0.100 TYP.	
e1	4.980	5.180	0.196	0.204
F	2.650	2.950	0.104	0.116
H	7.900	8.100	0.311	0.319
h	0.000	0.300	0.000	0.012
L	12.900	13.400	0.508	0.528
L1	2.850	3.250	0.112	0.128
V	7.500 REF.		0.295 REF.	
Φ	3.400	3.800	0.134	0.150

TO-263-3L Package Information

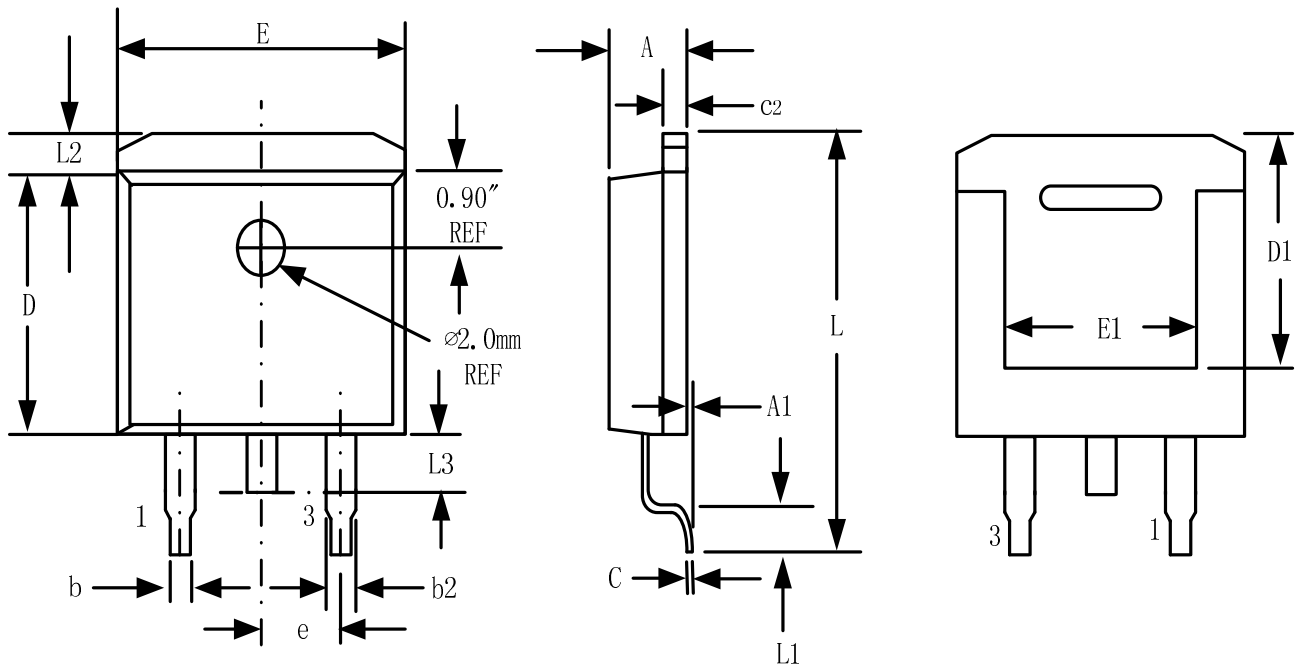

Symbol	Dimensions In Millimeters		Dimensions In Inches	
	Min.	Max.	Min.	Max.
A	4.32	4.57	0.170	0.180
A1	-	0.25		0.010
b	0.71	0.94	0.028	0.037
b2	1.15	1.40	0.045	0.055
c	0.46	0.61	0.018	0.024
c2	1.22	1.40	0.048	0.055
D	8.89	9.40	0.350	0.370
D1	8.01	8.23	0.315	0.324
E	10.04	10.28	0.395	0.405
E1	7.88	8.08	0.310	0.318
e	2.54 BSC		0.100 BSC	
L	14.73	15.75	0.580	0.620
L1	2.29	2.79	0.090	0.110
L2	1.15	1.39	0.045	0.055
L3	1.27	1.77	0.050	0.070

TO-220F Package Information

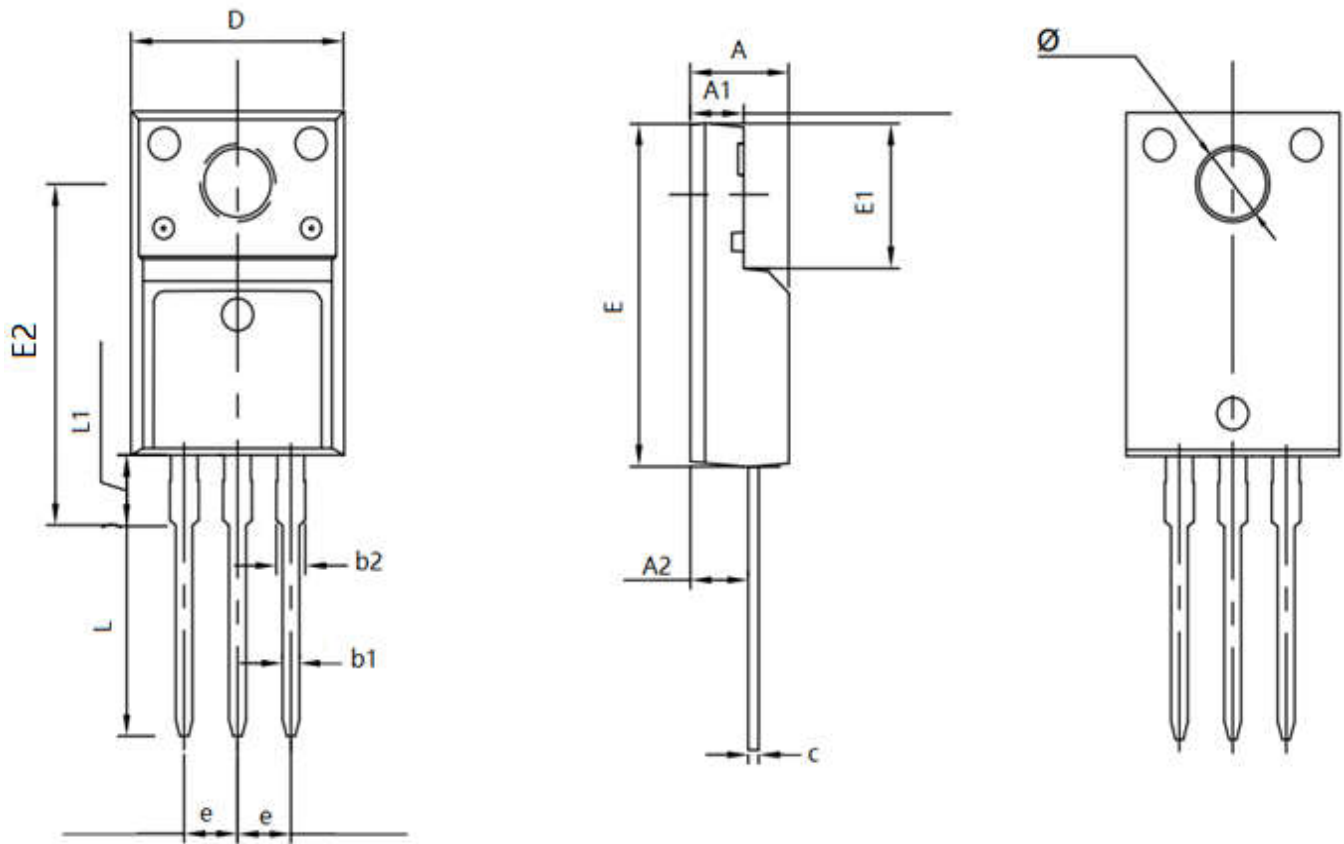

Symbol	Dimensions In Millimeters		Dimensions In Inches	
	Min.	Max.	Min.	Max.
A	4.500	4.900	0.177	0.193
A1	2.340	2.740	0.092	0.108
A2	2.560	2.960	0.101	0.117
b1	0.700	0.900	0.028	0.035
b2	1.180	1.580	0.046	0.062
c	0.400	0.600	0.016	0.024
D	9.960	10.360	0.392	0.408
E	15.670	15.970	0.617	0.629
E1	6.500	6.900	0.256	0.272
E2	15.500	16.100	0.610	0.634
e	2.540 TYP		0.100 TYP	
φ	3.080	3.280	0.121	0.129
L	12.640	13.240	0.498	0.521
L1	3.030	3.430	0.119	0.135