

DIO7002

5.5V, 2.5A Low Loss Power Distribution Switch

Features

- Input voltage: 2.7V to 5.5V
- Typical 70mΩ on-resistance
- 2.5A load current capability
- Programmable current limit
- Enable polarity:
DIO7002A: Active high
DIO7002B: Active Low
- Over current protection, short circuit protection and over temperature protection
- Reverse blocking (no body diode)
- No reverse current when power ON or power OFF
- Compact SOT23-5 package minimizes the board space

Descriptions

The DIO7002 power distribution switch is intended for applications where precision current limiting is required or heavy capacitive loads and short circuits are encountered. The power switch rising and falling times are controlled to minimize current surges during turning on/off.

The DIO7002 device limits the output current under a safe level by using a constant current mode when the output load exceeds the current limit threshold.

The DIO7002 is available in the SOT23-5 packages. It is rated over the -40°C to +85°C temperature range.

Applications

- USB Ports/Hubs
- Digital TV
- Set-Top Boxes
- VOIP Phones

Typical Application

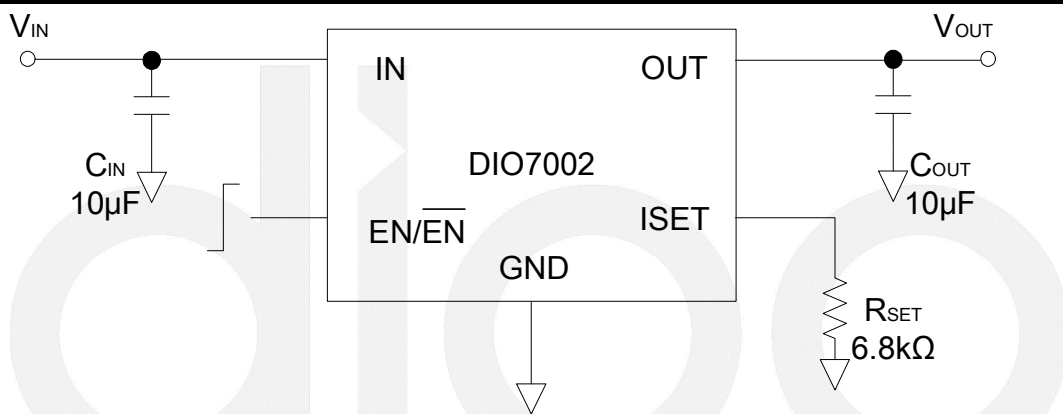

Ordering Information

Order Part Number	Top Marking	Enable		T _A	Package	
DIO7002AST5	YW2A	Active High	Green	-40 to +85°C	SOT23-5	Tape & Reel, 3000
DIO7002BST5	YW2B	Active Low	Green	-40 to +85°C	SOT23-5	Tape & Reel, 3000

Marking Definition

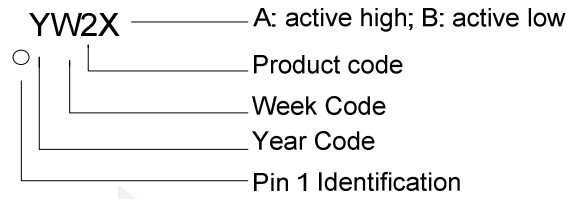

Pin Assignments

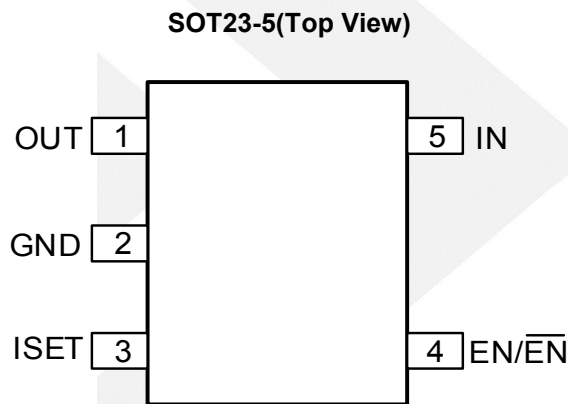

Figure 1 Pin Assignment

Pin Description

Pin Name	Pin number	Pin Description
OUT	1	Output pin, decoupled with a 10 μ F capacitor to GND
GND	2	Ground pin
ISET	3	External resistor used to set current limit threshold
EN/ $\bar{E}N$	4	ON/OFF control. Do not leave it floating
IN	5	Input pin, decoupled with a 10 μ F capacitor to GND



DIO7002

5.5V, 2.5A Low Loss Power Distribution Switch

Absolute Maximum Ratings

Stresses beyond those listed under "Absolute Maximum Rating" may cause permanent damage to the device. These are stress ratings only and functional operation of the device at these or any other condition beyond those indicated in the operational sections of the specifications is not implied. Exposure to absolute maximum rating conditions for extended periods may affect device reliability.

Parameter		Rating	Unit
All pins		-0.3 to 6	V
Power Dissipation ($P_D @ T_A = 25^\circ\text{C}$, SOT23-5)		0.6	W
Package Thermal Resistance	θ_{JA} , SOT23-5	250	$^\circ\text{C/W}$
	θ_{JC} , SOT23-5	130	
Junction Temperature Range		150	$^\circ\text{C}$
Lead Temperature (Soldering, 10 sec.)		260	$^\circ\text{C}$
Storage Temperature Range (T_{STG})		-65 to 150	$^\circ\text{C}$
ESD Susceptibility	HBM (Human Body Mode)	6	kV
	CDM (Charged Device Mode)	2	

Note: Input and output negative ratings may be exceeded if input and output diode current ratings are observed.

Recommended Operating Conditions

The Recommended Operating Conditions table defines the conditions for actual device operation to ensure optimal performance to the datasheet specifications. DIOO does not recommend exceeding them or designing to Absolute Maximum Ratings.

Parameter		Rating	Unit
IN		2.7 to 5.5	V
All other pins		0 to 5.5	V
Junction Temperature Range		-40 to 125	$^\circ\text{C}$
Ambient Temperature Range		-40 to 85	$^\circ\text{C}$



DIO7002

5.5V, 2.5A Low Loss Power Distribution Switch

Electrical Characteristics

$T_A=25\text{ }^\circ\text{C}$ $V_{IN} = 5\text{V}$, unless otherwise noted.

Symbol	Parameter	Conditions	Min.	Typ.	Max.	Unit
V_{IN}	Input Voltage Range		2.7		5.5	V
I_{SHDN}	Shut down Input Current	Open load, IC Disabled		0.2	1	μA
I_Q	Quiescent Supply Current	Open load, IC Disabled		60		μA
$R_{DS(ON)}$	FET R_{ON}			70		m Ω
$V_{EN(H)}$	EN Rising Threshold		2			V
$V_{EN(L)}$	EN Falling Threshold				0.8	V
I_{EN}	EN Leakage Current	$V_{EN}=5.0\text{V}$			1	μA
V_{IN_UVLO}	IN UVLO Threshold				2.5	V
V_{IN_HYS}	IN UVLO Hysteresis			0.25		V
I_{LIM}	Over Current Limit	$R_{SET}=6.8\text{k}\Omega$	0.9	1	1.2	A
$I_{LIM(min)}$				0.4		
$I_{LIM(max)}$				2.5		
T_{ON}	Turn-on Time	$R_L=10\Omega, C_{OUT}=1\mu\text{F}$		700		μs
T_{OFF}	Turn-off Time	$R_L=10\Omega, C_{OUT}=1\mu\text{F}$		20		μs
T_{SD}	Thermal Shut down Temperature			140		$^\circ\text{C}$
	Thermal Shut down Hysteresis			20		$^\circ\text{C}$

Block Diagram

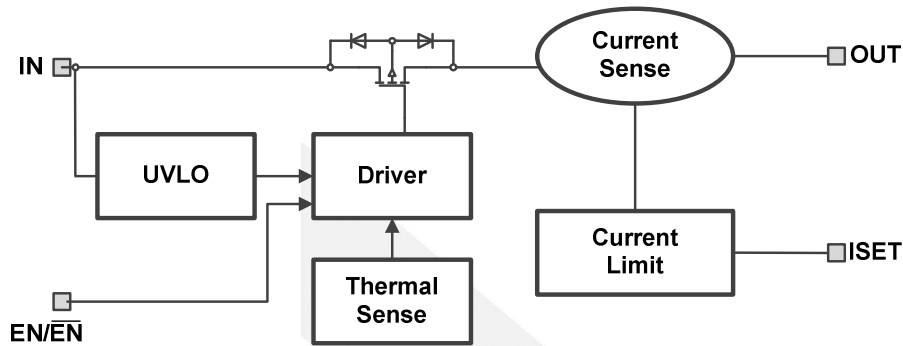

Application Information

Power Supply Considerations

A 10 μ F ceramic capacitor from V_{IN} to GND to prevent the input voltage from dropping during the hot-plug condition is strongly recommended. However higher capacitance could help reduce the voltage drop. Furthermore, bypassing the output with a 10 μ F ceramic capacitor improves the immunity of the device to short-circuit transients, because an output short will cause ringing on the input without the input capacitor. It could destroy the internal circuitry when the input transient voltage exceeds the absolute maximum supply voltage even for a short duration.

Enable

The logic enable controls the power switch, the bias for the charge pump, driver, and other circuitry to reduce the supply current. The supply current is reduced to less than 1 μ A when a logic low is present on EN pin. A logic high input on EN restores bias to the drive and control circuits and turns the power on. The enable input is compatible with both TTL and CMOS logic levels.

Current Limiting Setting

Current limit is programmable to protect the power source from over current and short circuit conditions. Connecting a resistor R_{SET} from I_{SET} pin to GND to control the current limit:

$$I_{LIM} (A) = 6800/R_{SET} (\Omega).$$

Current limit beyond 2.5A is not recommended.

Over-Current Protection

The DIO7002 responds to over current conditions by limiting output current to the I_{LIM} levels. When an over current condition is detected, the device maintains a constant output current and reduces the output voltage accordingly. Complete shut down occurs only if the fault is present long enough to activate thermal limit.

Two possible overload conditions can occur. In the first condition, an excessive load occurs while the device is enabled. When the excessive load occurs, very high currents may flow for a short time before the current limit circuit can react. After the current limit circuit has tripped (reached the over current trip threshold) the device switches into constant current mode to limit the current close to I_{LIM} .



DIO7002

In the second condition, the load is gradually increasing beyond the recommended operating current. The current is permitted to rise until the current limit threshold (I_{LIM}) is reached or until the thermal limit of the device is exceeded. The DIO7002 is capable of delivering current up to the current limit threshold (I_{LIM}) without damaging the device. Once the threshold has been reached, the device switches into its constant current mode.

Thermal Protection

Thermal protection prevents damage to the IC when heavy overload or short circuit conditions are present for extended periods of time. The conditions force the DIO7002 into constant current mode, and under short circuit conditions, the voltage across the switch is equal to the input voltage. The increased dissipation causes the junction temperature to rise to high levels. The protection circuit senses the junction temperature of the switch and shuts it off. Hysteresis is built into the thermal sense circuit, and after the device has cooled approximately 20 degrees, the switch turns back on. The switch continues to cycle in this way until the overload or input power is removed.



Typical Performance Characteristics

$T_A=25^\circ\text{C}$, $V_{IN}=5\text{V}$, $C_{IN}=C_{OUT}=10\mu\text{F}$, unless otherwise noted.

I_Q vs. V_{IN}

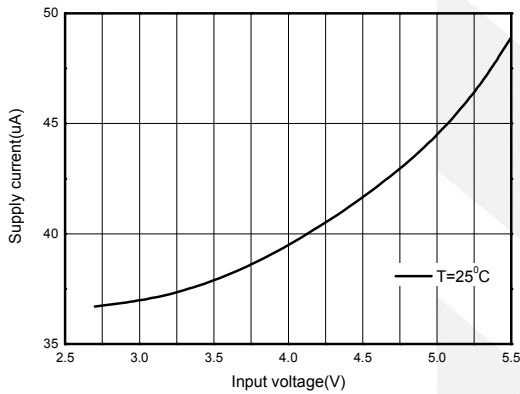

I_Q vs. Temperature

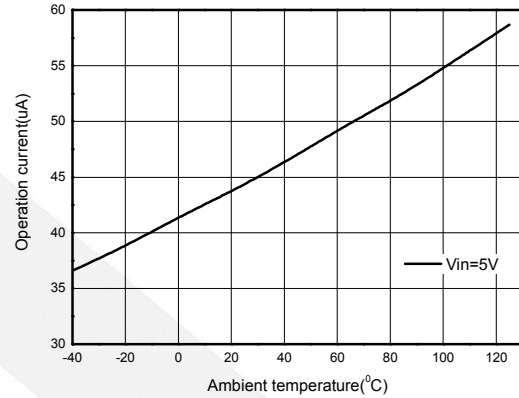

I_{SHDN} vs. V_{IN}

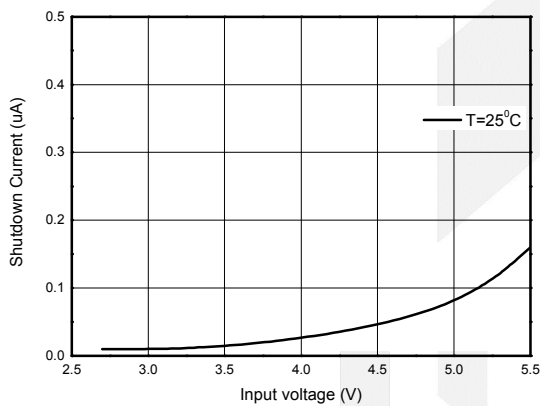

V_{EN} vs. V_{IN}

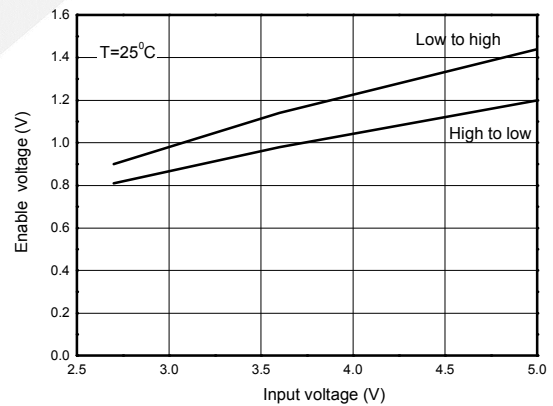

$R_{DS(ON)}$ vs. V_{IN}

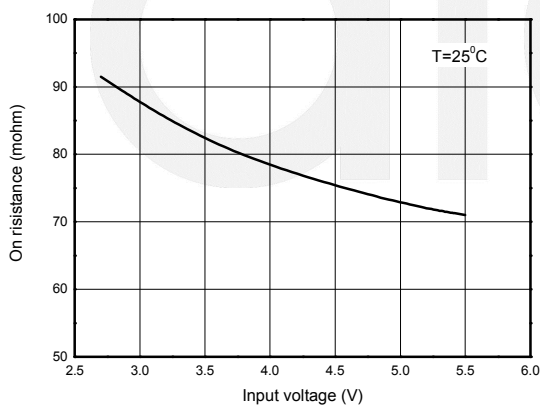

$R_{DS(ON)}$ vs. Temperature

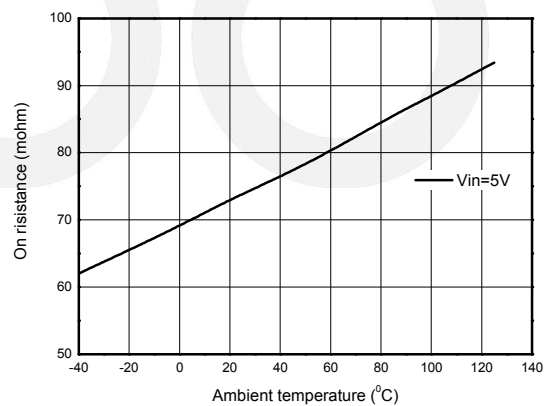



DIO7002

5.5V, 2.5A Low Loss Power Distribution Switch

I_{LIM} vs. V_{IN}

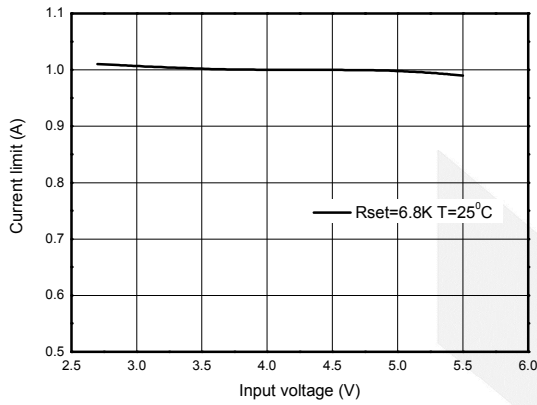

I_{LIM} vs. Temperature

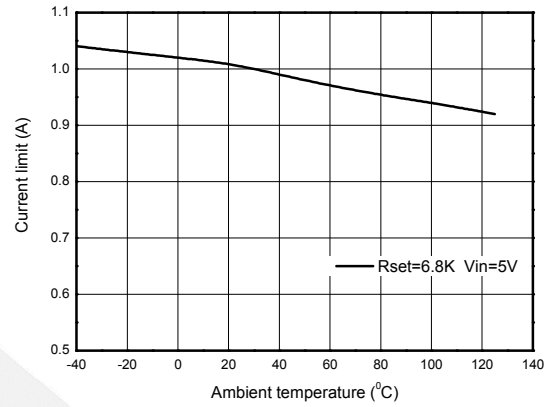

V_{IN} Start up ($R_{OUT}=2.5\Omega$)

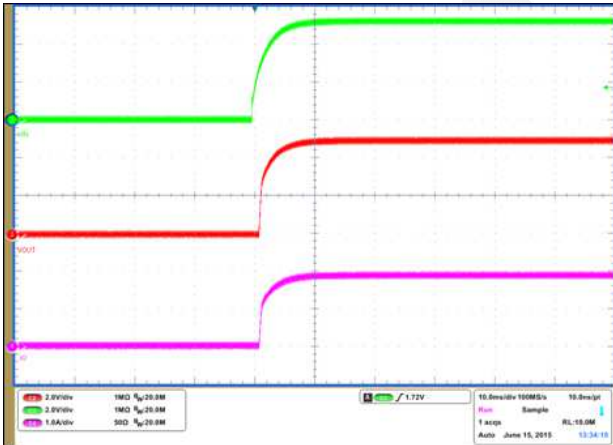

V_{IN} Shut down ($R_{OUT}=2.5\Omega$)

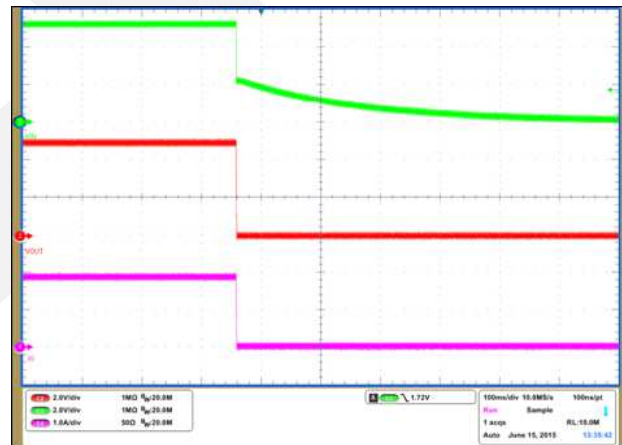

EN Start up ($R_{OUT}=2.5\Omega$)

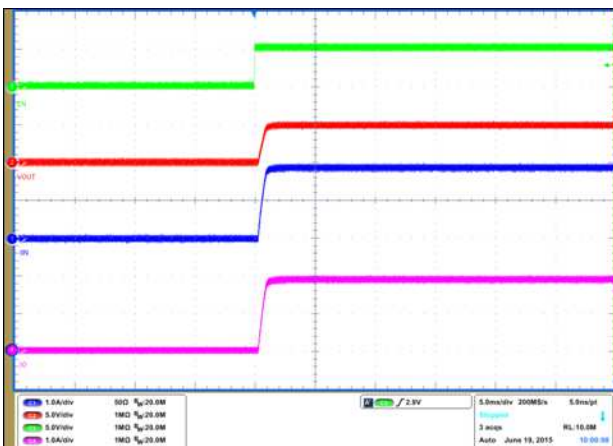

EN Shut down ($R_{OUT}=2.5\Omega$)

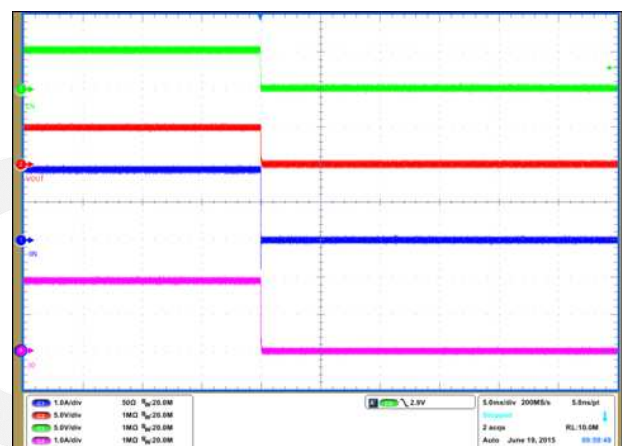

Over Temperature Protection
($R_{OUT}=10\Omega$)

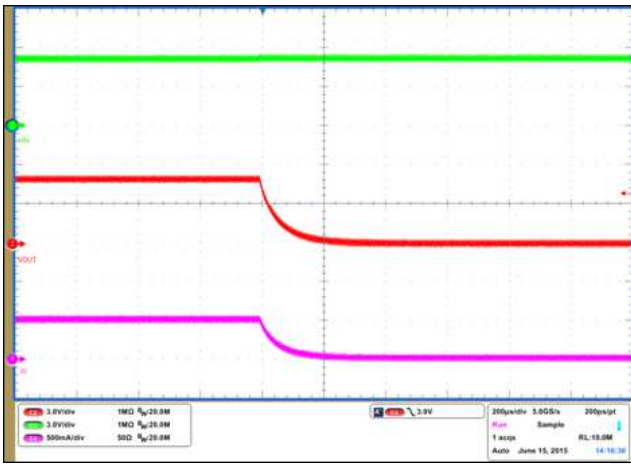

Over Temperature Recovery
($R_{OUT}=10\Omega$)

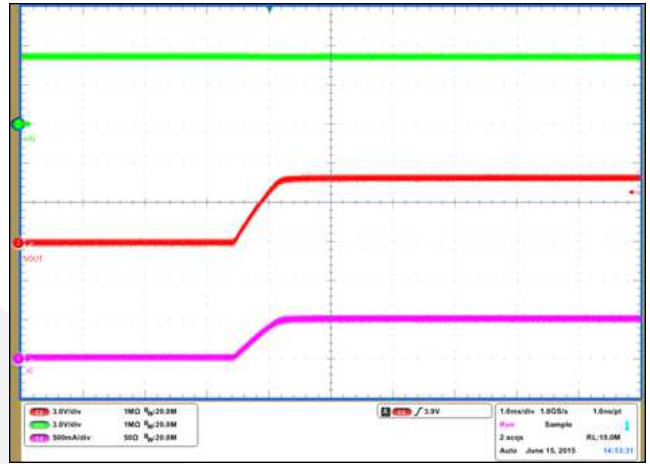

Over Current Protection
($R_{OUT}=2.5\Omega$)

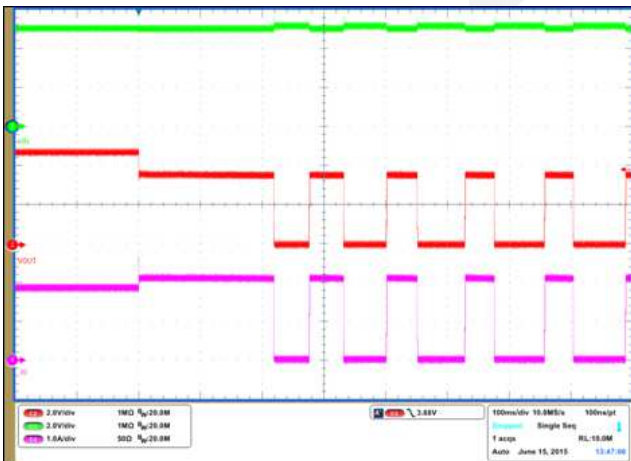

Over Current Recovery
($R_{OUT}=2.5\Omega$)

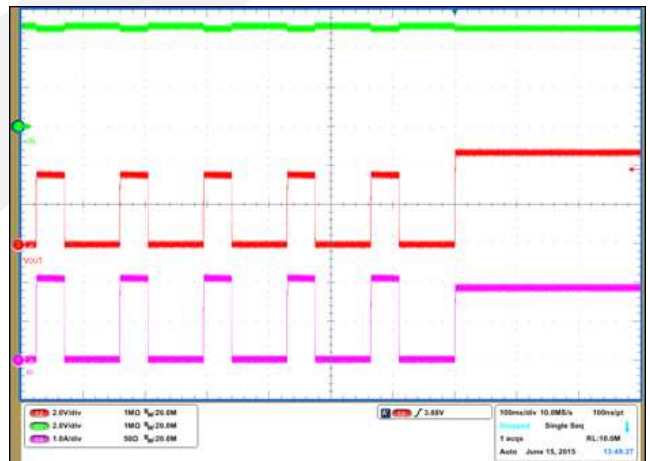

Short Circuit
($R_{OUT}=10\Omega$)

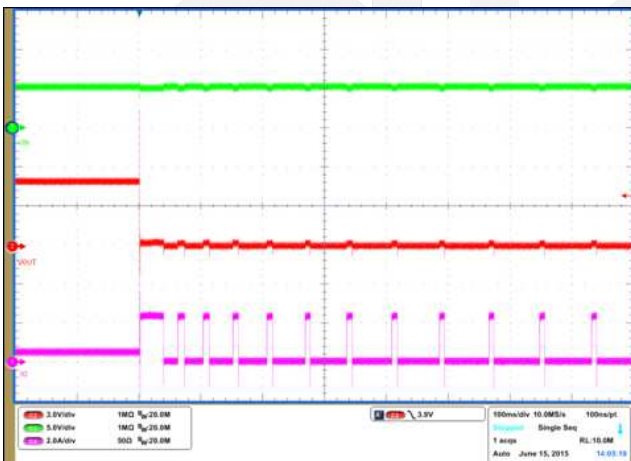

Short Circuit Recovery
($R_{OUT}=10\Omega$)

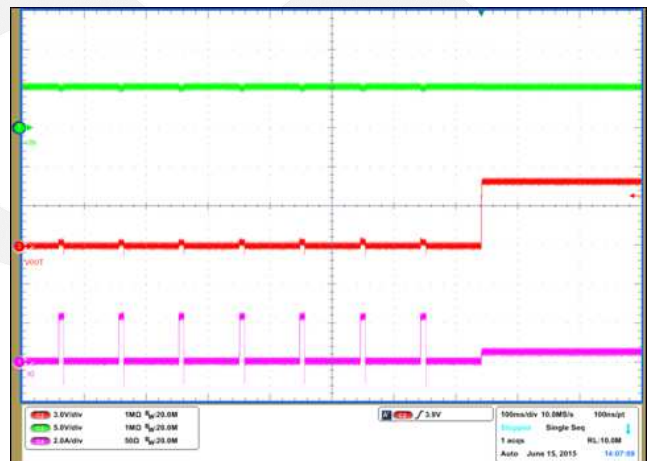



DIO7002

5.5V, 2.5A Low Loss Power Distribution Switch

$V_{IN_UVLO_H}$ ($R_{OUT}=10\Omega$)

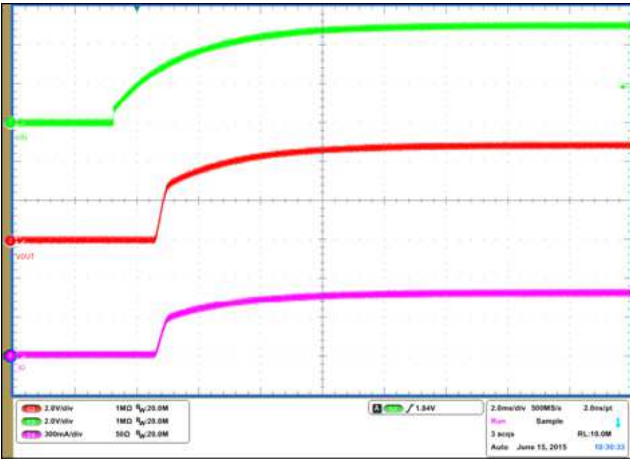

$V_{IN_UVLO_L}$ ($R_{OUT}=10\Omega$)

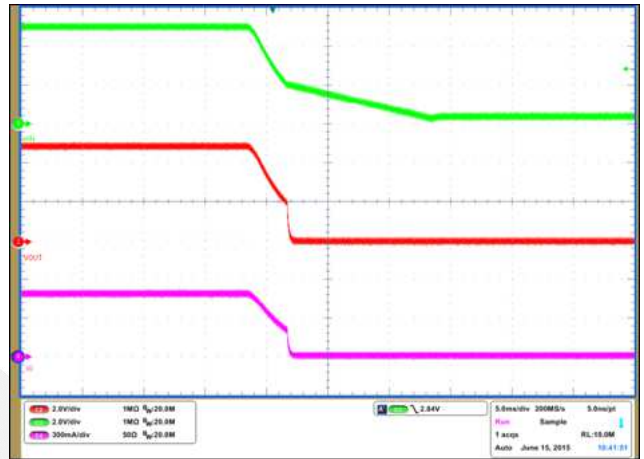

Turn on Time
($R_{OUT}=10\Omega$, $C_{OUT}=1\mu F$)

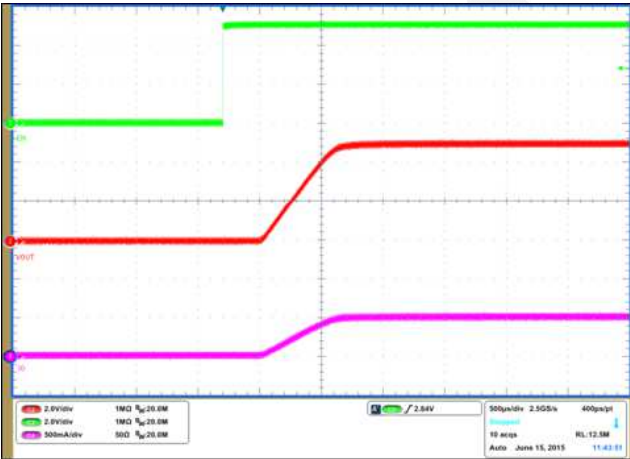

Turn off Time
($R_{OUT}=10\Omega$, $C_{OUT}=1\mu F$)

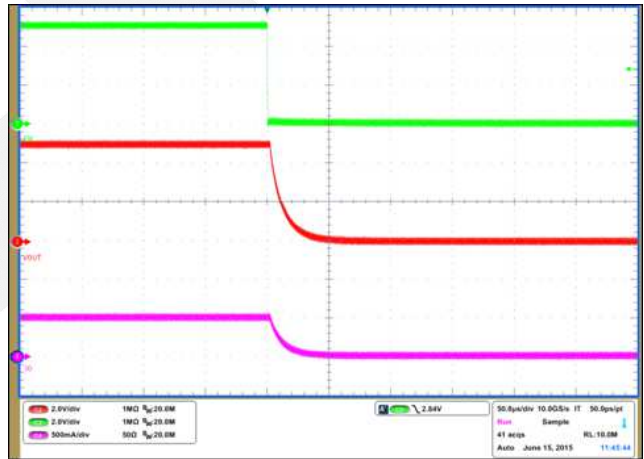

Physical Dimensions: SOT23-5

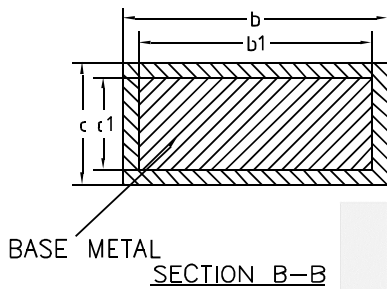
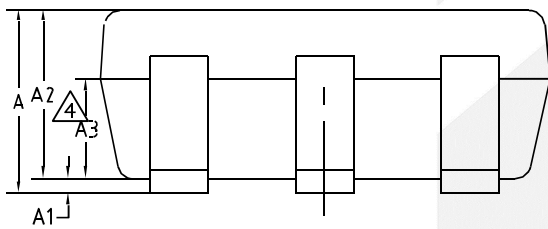
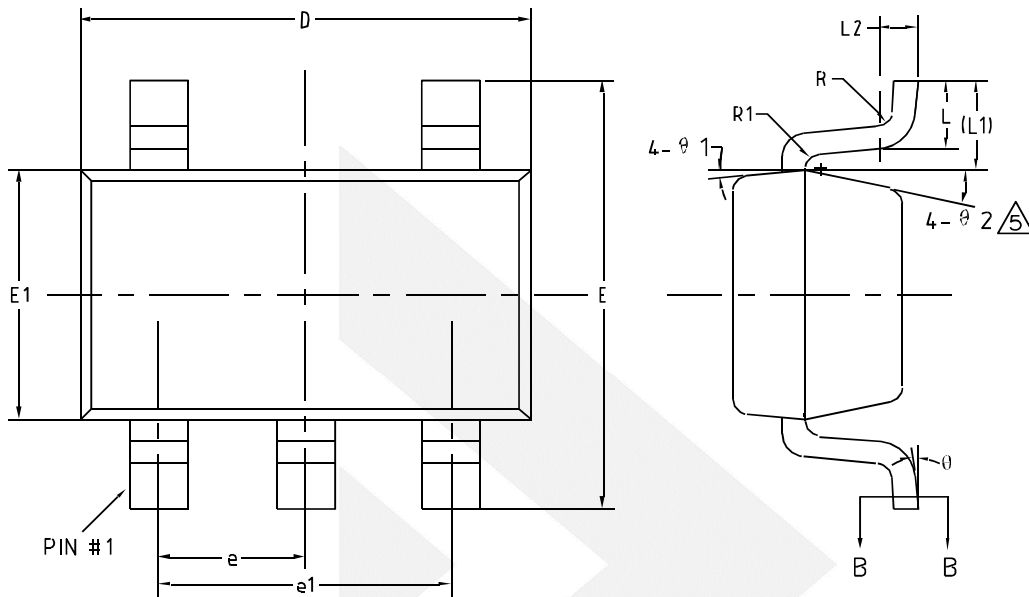

COMMON DIMENSIONS (UNITS OF MEASURE=MILLIMETER)			
Symbol	MIN	NOM	MAX
A	-	-	1.25
A1	0	-	0.15
A2	1.00	1.10	1.20
A3	0.60	0.65	0.70
b	0.36	-	0.50
b1	0.36	0.38	0.45
c	0.14	-	0.20
c1	0.14	0.15	0.16
D	2.826	2.926	3.026
E	2.60	2.80	3.00
E1	1.526	1.626	1.726
e	0.90	0.95	1.00
e1	1.80	1.90	2.00
L	0.35	0.45	0.60
L1	0.59REF		
L2	0.25BSC		
R	0.10	-	-
R1	0.10	-	0.20
θ	0°	-	8°
θ1	3°	5°	7°
θ2	6°	-	14°



DIO7002

5.5V, 2.5A Low Loss Power Distribution Switch

CONTACT US

Dioo is a professional design and sales corporation for high-quality and performance analog semiconductors. The company focuses on industry markets, such as, cell phone, handheld products, laptop, and medical equipment and so on. Dioo's product families include analog signal processing and amplifying, LED drivers and charger IC. Go to <http://www.dioo.com> for a complete list of Dioo product families.

For additional product information, or full datasheet, please contact with our Sales Department or Representatives.

dioo