

## SCHOTTKY DIODES

### FEATURES

- Extremely Fast Switching Speed

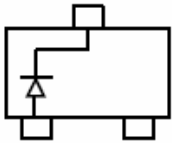
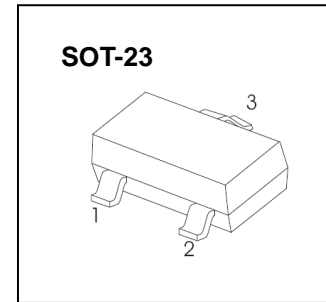

BAT54 MARKING: KL1

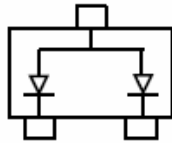

BAT54A MARKING: KL2

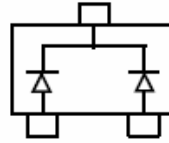

BAT54C MARKING: KL3

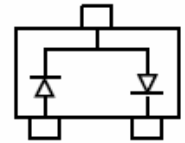

BAT54S MARKING: KL4

### Maximum Ratings @T<sub>A</sub>=25°C

Parameter	Symbol	Limits	Unit
Peak Repetitive Peak reverse voltage	V <sub>RRM</sub>	30	V
Working Peak Reverse Voltage	V <sub>RWM</sub>		
DC Blocking Voltage	V <sub>R</sub>		
Forward Continuous Current	I <sub>FM</sub>	200	mA
Power Dissipation	P <sub>D</sub>	200	mW
Storage temperature	T <sub>STG</sub>	-55-150	°C

### Electrical Characteristics @T<sub>A</sub>=25°C

Parameter	Symbol	Min.	Typ.	Max.	Unit	Conditions
Reverse Breakdown Voltage	V <sub>(BR)R</sub>	30			V	I <sub>R</sub> =100μA
Forward voltage	V <sub>F1</sub>			0.24	V	I <sub>F</sub> =0.1mA
	V <sub>F2</sub>			0.32	V	I <sub>F</sub> =1mA
	V <sub>F3</sub>			0.40	V	I <sub>F</sub> =10mA
	V <sub>F4</sub>			0.50	V	I <sub>F</sub> =30mA
	V <sub>F5</sub>			1	V	I <sub>F</sub> =100mA
Reverse current	I <sub>R</sub>			2	μA	V <sub>R</sub> =25V
Diode Capacitance	C <sub>D</sub>			10	pF	V <sub>R</sub> =1V, f=1MHz
Reverse Recovery Time	t <sub>rr</sub>			5	nS	I <sub>F</sub> =I <sub>R</sub> =10mA I <sub>rr</sub> =0.1X I <sub>R</sub> , R <sub>L</sub> =100Ω



## Typical Characteristics

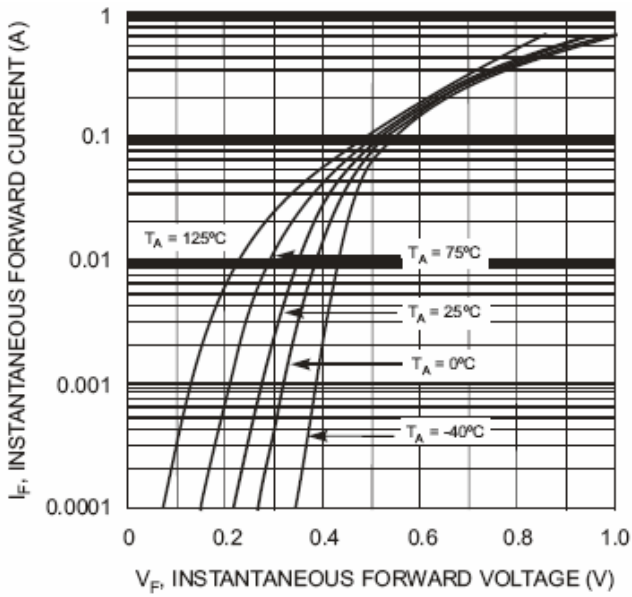

Fig. 1 Forward Characteristics

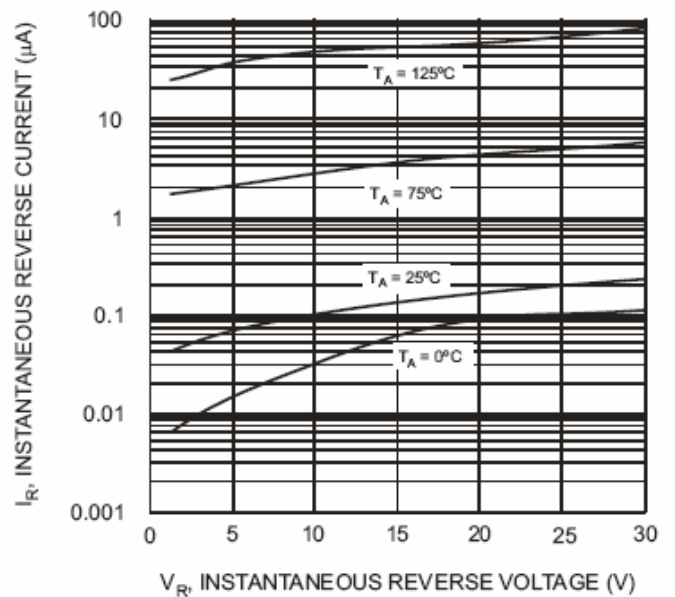

Fig. 2 Typical Reverse Characteristics

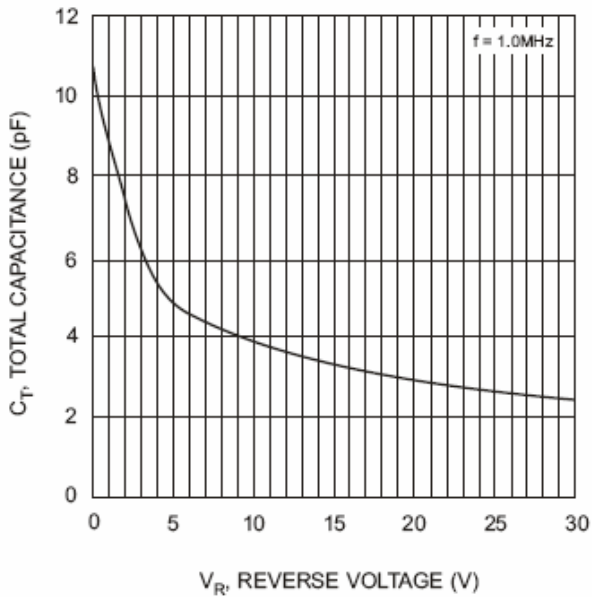

Fig. 3 Typical Capacitance vs. Reverse Voltage

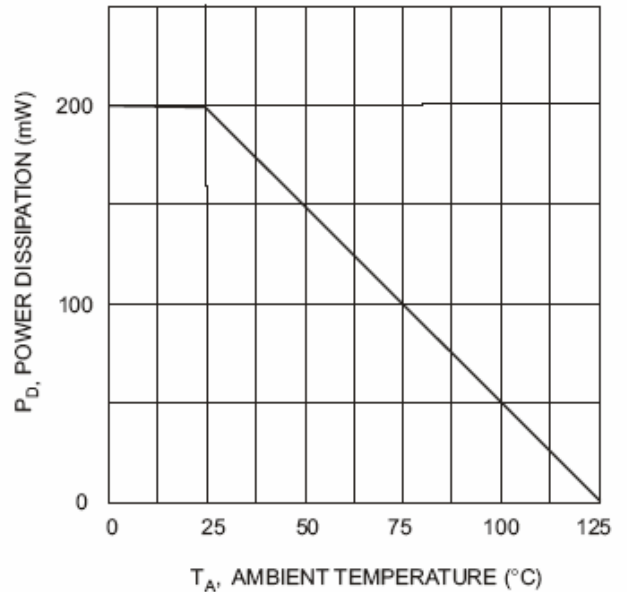

Fig. 4 Power Derating Curve

