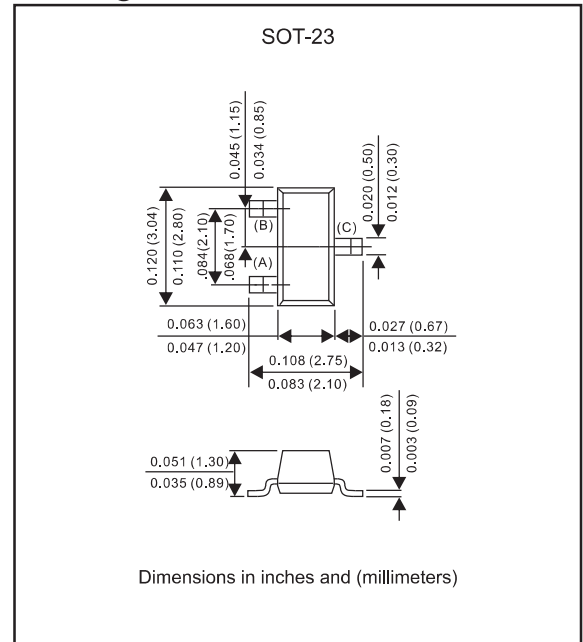

BAT54 / BAT54A / BAT54C / BAT54S**200mA Surface Mount Small Signal Schottky Diodes-30V****Features**

- Low current rectification and high speed switching.
- Small surface mount type.
- Up to 200mA current capability.
- Low forward voltage drop.
- Silicon epitaxial planar chip, metal silicon junction.
- Lead-free parts for green partner, exceeds environmental standards of MIL-STD-19500 /228
- High speed (trr < 5 ns)
- Suffix "-H" indicates Halogen-free part, ex.BAT54-H.

Mechanical data

- Epoxy:UL94-V0 rated flame retardant
- Case : Molded plastic, SOT-23
- Terminals : Solder plated, solderable per MIL-STD-750, Method 2026
- Mounting Position : Any

Package outline**Maximum ratings and Electrical Characteristics (AT $T_A=25^\circ\text{C}$ unless otherwise noted)**

PARAMETER	CONDITIONS	Symbol	MIN.	TYP.	MAX.	UNIT
Repetitive peak reverse voltage		V_{RRM}			30	V
Reverse voltage		V_R			30	V
Total Device dissipation	FR-5 board, (Note 1) $T_A = 25^\circ\text{C}$ Derate above 25°C	P_D			200 2.0	mW mW/ $^\circ\text{C}$
Repetitive peak forward current		I_{FRM}			300	mA
Forward surge current	tp<1s	I_{FSM}			600	mA
Forward current		I_F			200	mA
Thermal Resistance	Junction to ambient	$R_{\theta JA}$		500		$^\circ\text{C}/\text{W}$
Operating Junction temperature range		T_J	-55		+125	$^\circ\text{C}$
Storage temperature range		T_{STG}	-55		+125	$^\circ\text{C}$
Forward voltage	$I_F = 0.1 \text{ mA}$	V_F		0.220	0.240	V
	$I_F = 1 \text{ mA}$	V_F		0.290	0.320	V
	$I_F = 10 \text{ mA}$	V_F		0.350	0.400	V
	$I_F = 30 \text{ mA}$	V_F		0.410	0.500	V
	$I_F = 100 \text{ mA}$	V_F		0.520	1.000	V
Reverse current	$V_R = 25 \text{ V}$	I_R		0.5	2.0	μA
Diode capacitance	$V_R = 1 \text{ V}$, $f = 1\text{MHz}$	C_J		7.6	10.0	pF
Reverse recovery time	$I_F = I_R = 10 \text{ mAdc}$, $I_{R(REC)} = 1.0 \text{ mAdc}$	trr			5	ns

Note : 1.FR-5 = 1.0 x 0.75 x 0.062 in

Rating and characteristic curves for each diode (BAT54 / A / C / S)

FIG.1-TYPICAL FORWARD CHARACTERISTICS

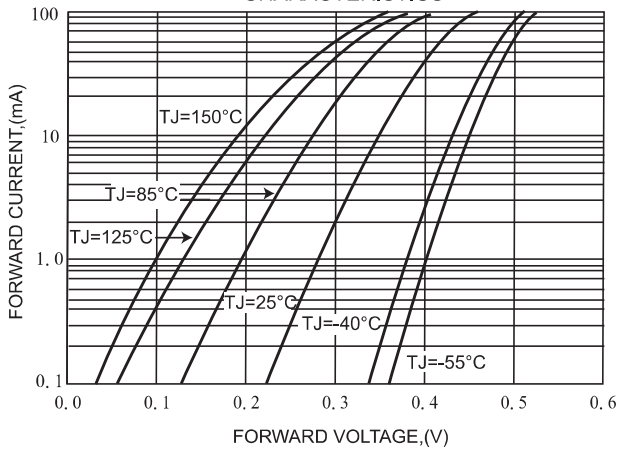

FIG.2 - TYPICAL LEAKAGE CURRENT CHARACTERISTICS

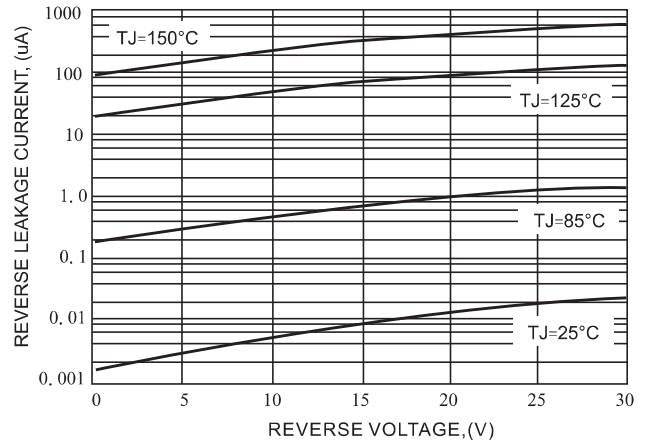
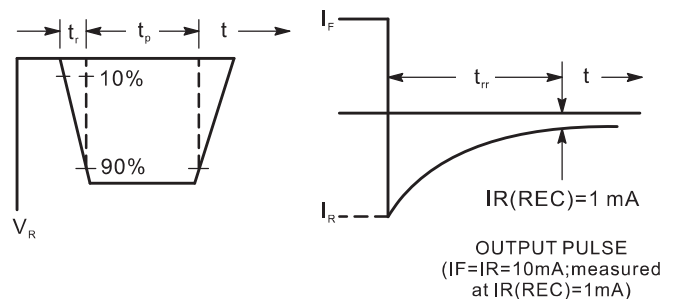
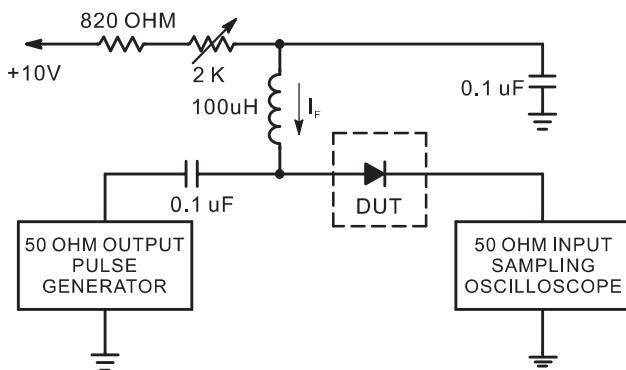
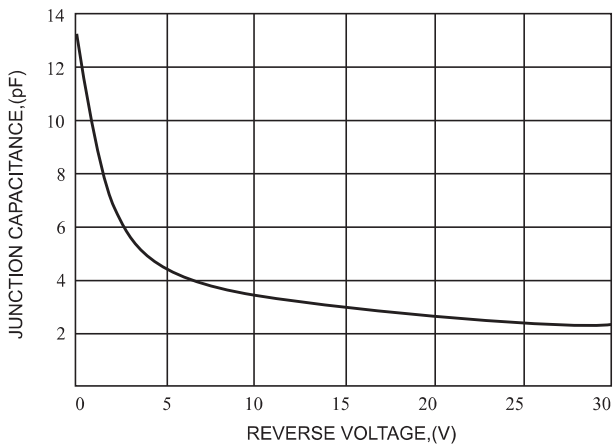

FIG.3-TYPICAL JUNCTION CAPACITANCE





- Notes : 1. A2.0 Kohm variable resistor adjusted for a forward Current (I_F) of 10mA.
 2. Input pulse is adjusted so $I_R(\text{peak})$ is equal to 10 mA.
 3. $t_p \gg t_{rr}$.

Recovery Time Equivalent Test Circuit

BAT54 / BAT54A / BAT54C / BAT54S

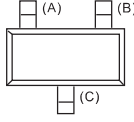
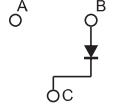
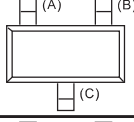
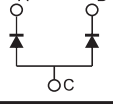
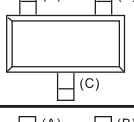
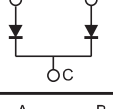
Pinning information

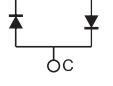
Type number	Marking code	Simplified outline	Symbol
BAT54	JV3, LV3, L4, KL1		
BAT54A	B6, L42, KL2		
BAT54C	5C, KL3, L43		
BAT54S	LD3, L44, KL4		

Suggested solder pad layout

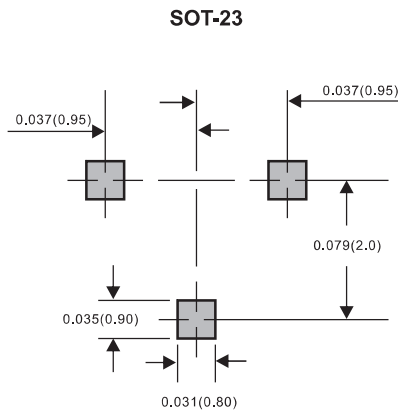

Dimensions in inches and (millimeters)

Reel packing

PACKAGE	REEL SIZE	REEL (pcs)	COMPONENT SPACING (m/m)	BOX (pcs)	INNER BOX (m/m)	REEL DIA, (m/m)	CARTON SIZE (m/m)	CARTON (pcs)	APPROX. GROSS WEIGHT (kg)
SOT-23	7"	3,000	4.0	30,000	183*183*123	178	382*262*387	240,000	11.6