

TOSHIBA Bi-CMOS Power Integrated Circuit Multi-Chip Package (MCP)

TB67B000HG

High voltage

3-Phase Full-Wave Sine-Wave PWM Brushless Motor Driver

The TB67B000HG is a high-voltage PWM BLDC motor driver. The product integrates a sine-wave PWM/wide-angle commutation controller and the high-voltage driver in a single package (“two-in-one”). It is designed to change the speed of a BLDC directly motor by using a speed control signal (analog) from a microcontroller.

Features

- A Controller and a high-voltage driver integrated in a single package.
Sine-wave PWM drive or wide-angle commutation drive is selectable.
- IGBTs arranged in three bridge units
- Built-in oscillator circuit (carrier frequency = $f_{osc}/252$ (Hz))
- High-side bootstrap supply: Built-in bootstrap diode
- Built-in overcurrent protection, thermal shutdown, undervoltage lockout, and motor-lock detection.
- On-chip regulator ($V_{reg} = 7$ V (typ.), 30 mA (max), $V_{refout} = 5$ V (typ.), 35 mA (max))
- Operating power supply voltage range: $V_{CC} = 13.5$ to 16.5 V
- Motor power supply operating voltage range: $V_{BB} = 50$ to 450 V

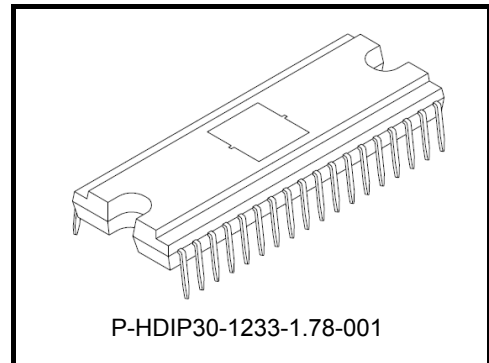

Weight: 2.59 g (typ.)

Block Diagram

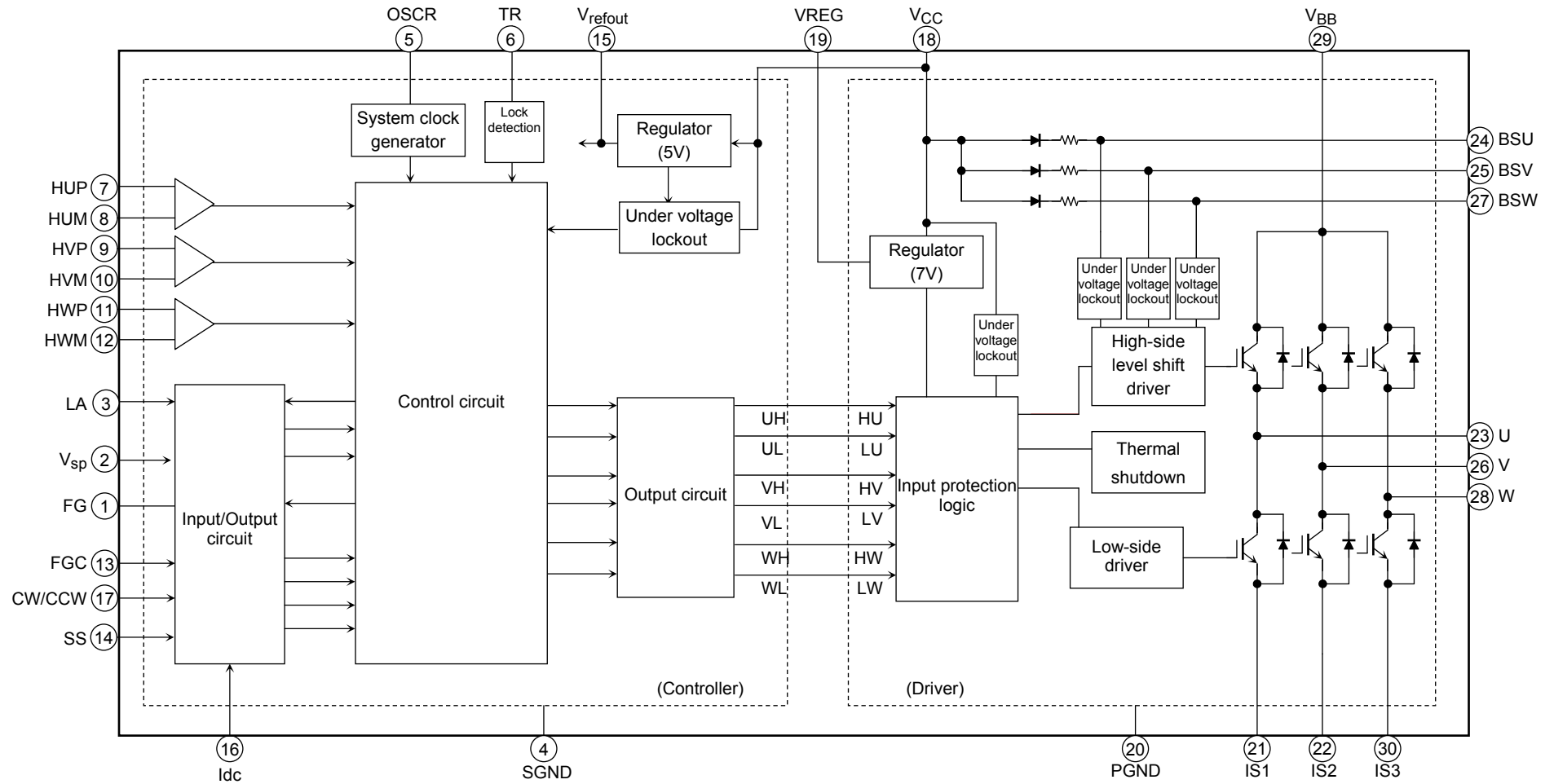

Pin Assignment

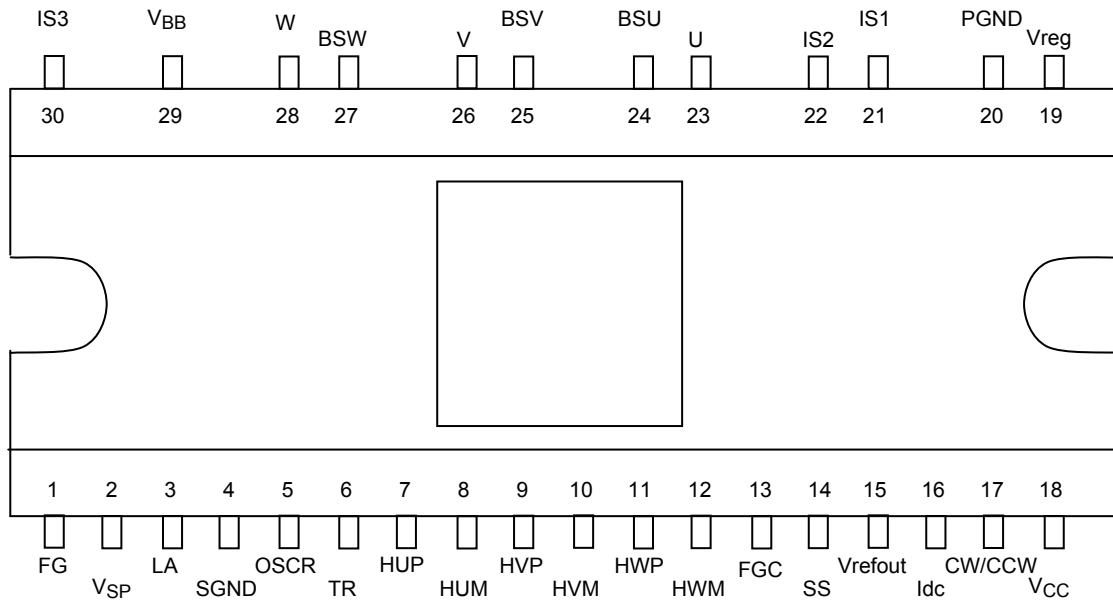

Note: Die pad on surface and PGND is connected. When using the heat sink, handle it not to short with the IC terminals. When applying the different potential with GND level to the heat sink, insulate with die pad and the heat sink.

Pin Description

Pin No.	Symbol	Description	Function
1	FG	FG signal output	FGC = H: FG = output 1ppr FGC = M: FG = output 2.4ppr FGC = L: FG = output 3ppr ppr: one pulse per one electrical angle
2	V _{SP}	Voltage command input	This pin has a pull-down resistor. (150 kΩ)
3	LA	Lead angle control input	This pin has a pull-down resistor. (200 kΩ) Input voltage range: 0 to 5V (V _{refout}) SS=H: 0 to 28° in 16 steps. SS=L: 0 to 58° in 32 steps.
5	OSCR	Resistor for oscillation	Connect a resistor for internal clock oscillation.
6	TR	Motor lock detection	Connect a capacitor for motor lock detection oscillation or connect to GND.
7	HUP	U-phase hall input+	When position signal outputs HHH or LLL, gate block protection drives. Built-in digital filter (≈ 1.6 μs)
8	HUM	U-phase hall input-	
9	HVP	V-phase hall input+	
10	HVM	V-phase hall input-	
11	HWP	W-phase hall input+	
12	HWM	W-phase hall input-	
13	FGC	FG output signal switch	This pin has a pull-down resistor. (100 kΩ) H: FG=output 1ppr. M: FG=output 2.4ppr. L: FG=output 3ppr. ppr: one pulse per one electrical angle
15	V _{refout}	Reference voltage output	5 V (typ.), 35 mA (max), Connecting a capacitor for voltage stability.
14	SS	Switch for commutation waveform	This pin has a pull-down resistor. (100 kΩ) H: Wide-angle commutation (150° commutation) L: Sine-wave PWM drive (180° commutation)
17	CW/CCW	Forward/Reverse switching input	This pin has a pull-down resistor. (100 kΩ) H: Forward L: Reverse
16	Idc	Current limit input	This pin has a pull-up resistor. (200 kΩ) DC link input Reference potential of 0.5 V. This pin has a RC filter (≈ 1 μs) and a digital filter (≈ 0.6 μs).
4	SGND	Ground pin	Signal ground. Connect with PGND.
19	VREG	Reference voltage output	7V (typ.), 30 mA (max). Connecting a capacitor for voltage stability.
18	V _{CC}	Power supply pin for the power stage	15 V (typ.)
20	PGND	Ground pin	Power ground Connect with SGND.
23	U	U-phase output pin	—
24	BSU	Bootstrap supply (phase U)	For connecting a bootstrap capacitor to the U-phase output.
21	IS1	U-phase IGBT emitter	For connecting a detecting resistor for motor coil current to the PGND pin.
22	IS2	V-phase IGBT emitter	For connecting a detecting resistor for motor coil current to the PGND pin.
25	BSV	Bootstrap supply (phase V)	For connecting a bootstrap capacitor to the V-phase output.
26	V	V-phase output pin	—
29	V _{BB}	High-voltage power supply pin	Power supply pin for driving a motor.
27	BSW	Bootstrap supply (phase W)	For connecting a bootstrap capacitor to the W-phase output.
28	W	W-phase output pin	—
30	IS3	W-phase IGBT emitter	For connecting a detecting resistor for motor coil current to the PGND pin.

Input/Output Equivalent Circuits

Equivalent circuit diagrams may be partially omitted or simplified for explanatory purposes.

Pin	Input/Output Signal	Internal Circuit
HUP HUM HVP HVM HWP HWM	Analog / Digital Hysteresis: ± 7.5 mV (typ.) Digital filter time constant: $1.6 \mu\text{s}$ (typ.)	
VSP	Analog VSP voltage range: 0 to 10 V Internal pull-down resistor: $150\text{k}\Omega$	
CW/CCW SS	Digital L: 0.8 V (max) H: Vrefout - 1 V (min) Internal pull-down resistor: $100\text{k}\Omega$	
LA	Analog LA voltage range: 0 to 5 V (Vrefout) Internal pull-down resistor: $200\text{k}\Omega$	
Idc	Analog Analog filter time constant: $1.0 \mu\text{s}$ (typ.) Digital filter time constant: $0.6 \mu\text{s}$ (typ.) Internal pull-up resistor: $200\text{k}\Omega$	
FGC	Digital L: 0.8 V (max) M: 2.0V(min) 3.0V(max) H: Vrefout - 1 V (min) Internal pull-down resistor: $100\text{k}\Omega$	

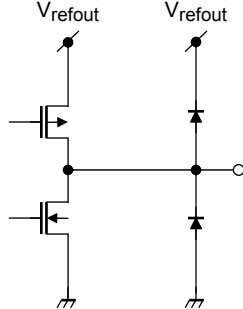
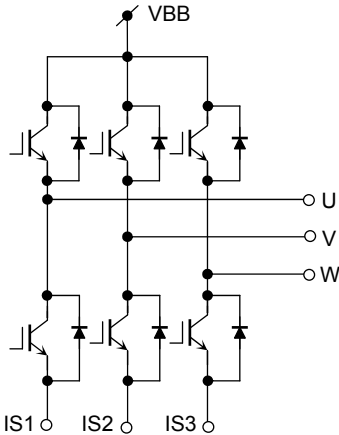
Pin	Input/Output Signal	Internal Circuit
FG	Digital Push-pull output (± 2 mA max) FGC=H: 1ppr FGC=M: 2.4ppr FGC=L: 3ppr	
U V W IS1 IS2 IS3	U,V,W-phase output pin U,V,W-phase IGBT emitter pin	

Absolute Maximum Ratings (Ta = 25°C)

Characteristics	Symbol	Rating	Unit
Power supply voltage	V _{BB}	500	V
	V _{CC}	18	
Input voltage	V _{in (1)}	-0.3 to V _{CC} (Note 1)	V
	V _{in (2)}	-0.3 to V _{refout} +0.3 (Note 2)	
Output current (DC)	I _{OUT}	2	A
Output current (pulse 1ms)	I _{OUTP}	3 (Note 3)	A
V _{reg} current	I _{reg}	30	mA
V _{refout} current	I _{refout}	35	mA
Power dissipation	P _D	35 (Note 4)	W
Operating temperature	T _{opr}	-30 to 115 (Note 5)	°C
Storage temperature	T _{stg}	-55 to 150	°C

Note: The absolute maximum ratings of a semiconductor device are a set of ratings that must not be exceeded, even for a moment. Do not exceed any of these ratings. Exceeding the rating (s) may cause the device breakdown, damage or deterioration, and may result injury by explosion or combustion. Please use the TB67B000HG within the specified operating ranges.

Using continuously under heavy loads (e.g. the application of high temperature/current/voltage and the significant change in temperature, etc.) may cause this product to decrease in the reliability significantly even if the operating conditions (i.e. operating temperature/current/voltage, etc.) are within the absolute maximum ratings and the operating ranges.

Please design the appropriate reliability upon reviewing the Toshiba Semiconductor Reliability Handbook ("Handling Precautions"/"Derating Concept and Methods") and individual reliability data (i.e. reliability test report and estimated failure rate, etc).

Note 1: V_{in (1)} pin: V_{SP} and LA

Note 2: V_{in (2)} pin: HUP, HUM, HVP, HVM, HWP, HWM, SS, FGC, CW/CCW, and I_{dc}.

Note 3: Apply pulse

Note 4: Package thermal resistance ($\theta_{j-c} = 1 \text{ }^\circ\text{C/W}$) with an infinite heat sink at Ta = 25°C

Note 5: The operating temperature range is determined according to the P_D MAX – Ta characteristics.

Operating conditions (Ta = 25°C)

Characteristics	Symbol	Min	Typ.	Max	Unit
Power supply voltage	V _{BB}	50	280	450	V
	V _{CC}	13.5	15	16.5	
Oscillation frequency	F _{OSC}	3.5	5	6.4	MHz
Output current	I _{out}	—	—	2	A
Operating temperature	T _{opr}	-30 (Note 6)	—	115 (Note 6)	°C

Note 6: The operating temperature range is determined according to the P_D MAX – Ta characteristics.

Package Power Dissipation

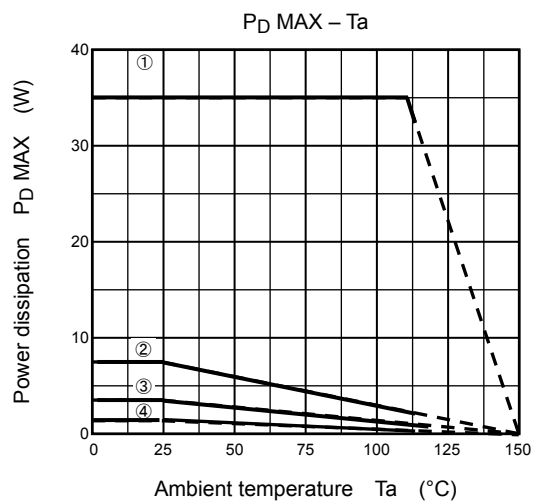

- ① INFINITE HEAT SINK
: $R_{\theta j-c} = 1^{\circ}\text{C/W}$
- ② When mounted on the board (74.2 × 114.3 × 1.6 mm, Cu20%), HEAT SINK (10 × 10 × 1 mm, Cu)
: $R_{\theta j-a} = 17^{\circ}\text{C/W}$
- ③ When mounted on the board (74.2 × 114.3 × 1.6 mm, Cu20%)
: $R_{\theta j-a} = 35^{\circ}\text{C/W}$
- ④ IC only
: $R_{\theta j-a} = 53^{\circ}\text{C/W}$

Electrical Characteristics (Ta = 25°C)

Characteristics		Symbol	Test Condition	Min	Typ.	Max	Unit	
Current dissipation		I_{BB}	$V_{BB} = 450\text{ V}$	—	—	0.5	mA	
		I_{CC}	$V_{CC} = 15\text{ V}$	—	5	10		
Current consumption of bootstrap		$I_{BS}(\text{ON})$	$V_{BS} = 15\text{ V}$, high-side ON	—	210	410	μA	
		$I_{BS}(\text{OFF})$	$V_{BS} = 15\text{ V}$, high-side OFF	—	180	370		
Input current		$I_{IN}(\text{LA})$	$V_{in} = 5\text{ V}$, LA	—	25	50	μA	
		$I_{IN}(\text{Vsp})$	$V_{in} = 5\text{ V}$, V_{sp}	—	35	70		
		$I_{IN}(\text{Idc})$	$V_{in} = \text{GND}$, I_{dc}	—	-25	-50		
		$I_{IN}(1)$	$V_{in} = 5\text{ V}$, CW/CCW, FGC, SS	—	50	100		
Input voltage	V_{IN1}	H	CW/CCW, FGC, SS	$V_{refout-1}$	—	V_{refout}	V	
		L		0	—	0.8		
	V_{IN2}	H	FGC	4	—	V_{refout}	V	
		M		2	—	3		
		L		0	—	1		
	$V_{SP(H)}$	T	Test mode for motor shipping SS=H	8.2	—	10	V	
		H	PWM ON duty 95% SS=H	5.1	5.4	5.7		
		M	Refresh → Start motor operation, SS=H	1.8	2.1	2.4		
		L	Turned-off → Refresh SS=H	0.7	1.0	1.3		
	$V_{SP(L)}$	T	Test mode for motor shipping SS=L	8.2	—	10	V	
		H	PWM ON duty 92% SS=L	5.1	5.4	5.7		
		M	Refresh → Start motor operation, SS=L	1.8	2.1	2.4		
		L	Turned-off → Refresh SS=L	0.7	1.0	1.3		
	PWM oscillation frequency (Carrier frequency)		$F_C(20)$	OSC/R = 68 k Ω	18	20	22	kHz
			$F_C(18)$	OSC/R = 75 k Ω	16.2	18	19.8	
	Motor lock detection		TONTR	TR=0.01 μF Driving time (Note)	3.33	5	8.33	s
		TOFFTR	TR=0.01 μF Turn off time (Note)	20	30	46.15	s	
		FTR	TR=0.01 μF frequency	65	100	150	Hz	
Lead angle offset (LA)		$T_{LAH(0)}$	LA = 0 V or open, Hall IN = 100 Hz SS=H	—	0	—	$^\circ$	
		$T_{LAH(2.5)}$	LA = 2.5 V, Hall IN = 100 Hz SS=H	11.25	15	18.75		
		$T_{LAH(5)}$	LA = 5 V, Hall IN = 100 Hz SS=H	26.25	28.125	—		
Lead angle offset		$T_{LAL(0)}$	LA = 0 V or Open, Hall IN = 100 Hz SS=L	—	0	—	$^\circ$	
		$T_{LAL(2.5)}$	LA = 2.5 V, Hall IN = 100 Hz SS=L	26	30	33		
		$T_{LAL(5)}$	LA = 5 V, Hall IN = 100 Hz SS=L	52	57	60		
Hall device input	Input sensitivity	V_S	Difference input	40	—	—	mVpp	
	In-phase range	V_W		0.5	—	4.0	V	

	Input hysteresis	VH (1)	(Note)	±1.5	±7.5	±13.5	mV
Hall IC input	VIN4	H	HUP, HVP, HWP: HUM,HVM,HWM=Vrefout/2	$V_{refout} - 1$	—	V_{refout}	V
		L		0	—	0.8	
Current detection		V _{dc}	I _{dc} ,	0.475	0.5	0.525	V
Output voltage		VFG (H)	I _{OUT} = 2 mA FG	4	—	—	V
		VFG (L)	I _{OUT} = -2 mA FG	—	—	1	
		V _{refout1}	I _{OUT} = 15 mA V _{refout}	4.7	5.0	5.3	
		V _{refout2}	I _{OUT} = 35 mA V _{refout}	4.5	5.0	5.3	
		V _{reg}	I _{OUT} = 30 mA V _{reg}	6.5	7	7.5	
Output saturated voltage		V _{CEsatH}	V _{CC} = 15 V, I _C = 1 A, High side	—	2.3	3.2	V
		V _{CEsatL}	V _{CC} = 15 V, I _C = 1 A, Low side	—	2.3	3.2	
Forward voltage of FRD		V _{FH}	I _F = 1 A, High side	—	2.1	3.1	V
		V _{FL}	I _F = 1 A, Low side	—	2.1	3.1	
Forward voltage of BSD		V _F (BSD)	I _F = 500 μA	—	0.9	1.2	V
Over heat protection		TSD	(Note)	135	—	185	°C
		TSDhys		—	50	—	
V _{CC} Undervoltage lockout (Driver)		V _{CC} (H)	Undervoltage positive-going threshold	10.5	11.5	12.5	V
		V _{CC} (L)	Undervoltage negative-going threshold	10	11	12	
VBS Undervoltage lockout (Driver)		VBS (H)	Undervoltage positive-going threshold	8.5	9.5	10.5	V
		VBS (L)	Undervoltage negative-going threshold	8	9	9.5	
Output delay time		t _{on}	V _{BB} = 280 V, V _{CC} = 15 V, I _C = 1 A	—	1.2	3	μs
		t _{off}	V _{BB} = 280 V, V _{CC} = 15 V, I _C = 1 A	—	1	3	
Input delay time		T _{DC}	I _{dc} (f _{osc} = 5 MHz)	—	3.5	—	μs
FRD reverse recovery time		t _{rr}	V _{BB} = 280 V, V _{CC} = 15 V, I _C = 1 A	—	150	—	ns

(Note): Toshiba does not implement testing before shipping.

Functional Description

1. Basic operation

The motor is driven by 120° commutation. When the positional signal reaches number of rotations $f = 1$ Hz or higher, the rotor position is estimated according to the positional signal and the motor is driven with the lead angle based on the input voltage of the LA pin.

From start to 1 Hz: Driven by square wave (120° commutation)

1Hz or higher: Driven by sine-wave PWM (180° commutation) or wide-angle commutation (150° commutation)

When $f_{osc} = 5\text{MHz}$, approx. 1 Hz.

*: When f is 1Hz or higher, the motor is driven by the command of the LA pin.

When f is 1Hz or less or the motor is driven with reverse rotation direction (according to the timing chart), it is driven by 120° commutation (lead angle is 0°).

Driven system (sine-wave PWM or wide-angle commutation) can be switched by the SS pin. Setting of lead angle is different between these driving systems.

SS	Driving system	Lead angle
Low	Sine-wave PWM drive (180° commutation)	0 to 58° / 32 steps
High	Wide-angle commutation (150° commutation)	0 to 28° / 16 steps

2. Voltage Command (V_{SP}) Signal and Bootstrap Voltage Regulation

SS=L

- (1) When $V_{SP} \leq 1.0$ V:

The commutation signal outputs are disabled (i.e., gate protection is activated).

- (2) When $1.0 \text{ V} < V_{SP} \leq 2.1$ V:

The low-side transistors are turned on at a regular (PWM carrier) frequency. (ON duty: $18/f_{osc}$)

- (3) When $2.1 \text{ V} < V_{SP} \leq 7.3$ V:

During sine-wave PWM drive, the commutation signals directly appear externally. During square-wave drive, the low-side transistors are forced on at a regular (PWM carrier) frequency. (ON duty: $18/f_{osc}$)

In stop state (Forward: 1Hz or less, Reverse: 5Hz or less), commutation signals are outputted after V_{SP} ($V_{SP} > 2.1$ V) is inputted and the refresh function operates for 1.5ms (typ.). In operation state (Forward: more than 1Hz, Reverse: more than 5Hz), commutation signals are outputted after V_{SP} ($V_{SP} > 2.1$ V) is inputted.

Note: In startup, low-side transistor should be turned on ($1.0 \text{ V} < V_{SP} \leq 2.1$ V) for a certain period to charge gate power supply of high-side transistors.

- (4) When $8.2 \text{ V} \leq V_{SP} \leq 10$ V (test mode for motor shipping):

The TB67B000HG drives in sine-wave drive mode with lead angle of zero. However, it drives in square-wave mode in detecting reverse rotation.

When V_{SP} reaches 7.9 V (typ.), lead angle switches to zero.

The PWM duty cycle is calculated as $PWM_carrier_frequency \times 92\%$ (typ.) and kept the constant value ($5.4 \text{ V}(\text{typ.}) \leq V_{SP}$).

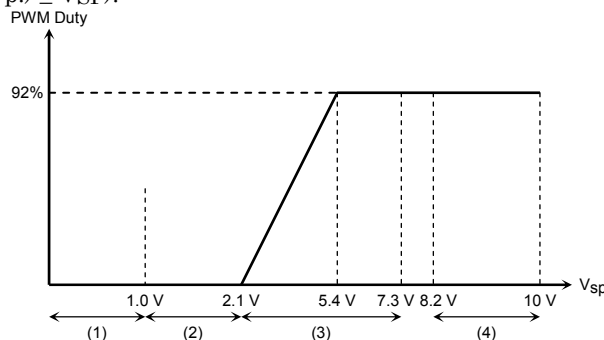

SS=H

- (1) When $V_{SP} \leq 1.0$ V:
The commutation signal outputs are disabled (i.e., gate protection is activated).
- (2) When 1.0 V < $V_{SP} \leq 2.1$ V:
The low-side transistors are turned on at a regular (PWM carrier) frequency. (ON duty: $18/f_{osc}$)
- (3) When 2.1 V < $V_{SP} \leq 7.3$ V:
During wide-angle commutation, the commutation signals directly appear externally. During square-wave drive, the low-side transistors are forced on at a regular (PWM carrier) frequency. (ON duty: $18/f_{osc}$)
In stop state (Forward: 1Hz or less, Reverse: 5Hz or less), commutation signals are outputted after V_{SP} ($V_{SP} > 2.1$ V) is inputted and the refresh function operates for 1.5ms (typ.). In operation state (Forward: more than 1Hz, Reverse: more than 5Hz), commutation signals are outputted after V_{SP} ($V_{SP} > 2.1$ V) is inputted.

Note: In startup, low-side transistor should be turned on (1.0 V < $V_{SP} \leq 2.1$ V) for a certain period to charge gate power supply of high-side transistors.

- (4) When 8.2 V $\leq V_{SP} \leq 10$ V (test mode):
The TB67B000HG drives in wide-angle commutation mode with lead angle of zero. However, it drives in square-wave mode in detecting reverse rotation.
When V_{SP} reaches 7.9 V (typ.), lead angle switches to zero.
The PWM duty cycle is calculated as $PWM_carrier_frequency \times 95\%$ (typ.) and kept the constant value (5.4 V $\leq V_{SP}$ (typ.)).

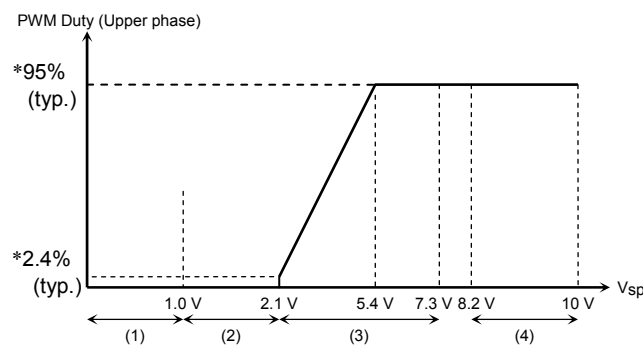

*: Maximum ON duty: $T_{on} = 95\%$ (typ.) when $V_{SP} = 5.4$ V (typ.)
Minimum ON duty: $T_{on} = 2.4\%$ (typ.) when $V_{SP} = 2.1$ V (typ.).

Ex.: When $f_{osc} = 5$ MHz, maximum ON time = 48 μ s (typ.) ($f_c = 19.8$ kHz)
minimum ON time = 1.2 μ s (typ.) ($f_c = 19.8$ kHz)

3. Dead Time Insertion (cross conduction protection)

To prevent a short-circuit between external low-side and high-side power elements during sine-wave PWM drive, a dead time is digitally inserted between the turn-on of one side and the turn-off of the other side. (The dead time is also implemented at the full duty cycle during square-wave drive.)

$$T_d = 9/f_{osc}$$

When $f_{osc} = 5 \text{ MHz}$, $T_d \approx 1.8 \mu\text{sec}$ ($9/f_{osc}$)

f_{osc} = reference clock (CR oscillation frequency)

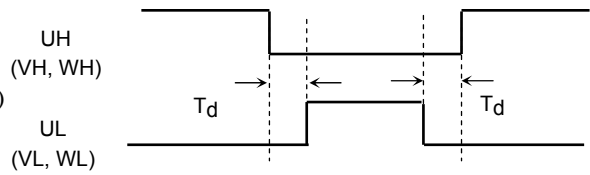

When input voltage (V_{SP}) is more than 2.1 V and the hall signal frequency is 1Hz or less, the upper phase (UH, VH, and WH) operates PWM drives (according to V_{SP}) with 120° commutation. And the lower phase (UL, VL, and WL) operates with 120° commutation. It refreshes in off timing. (In case of reverse direction drive, the operation is the same as forward direction drive.)

Output waveform (Image)

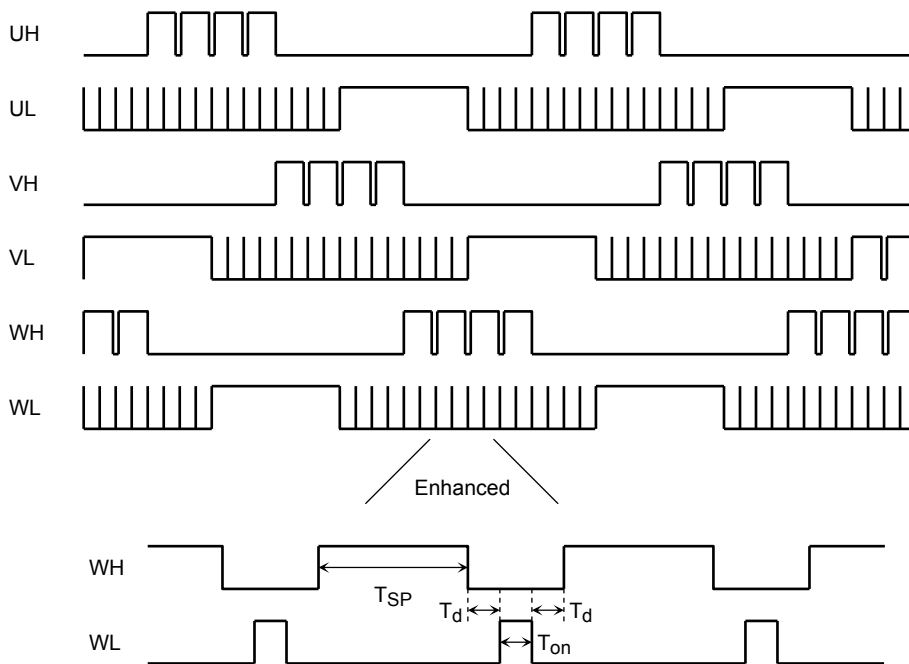

T_{SP} : Changeable by V_{SP} . (The condition in this figure: $V_{SP} = 5.4 \text{ V}$ (typ.)), $T_{on} = 18/f_{osc}$, $T_d = 9/f_{osc}$.

*: Lead angle offset (LA pin) is not activated when hall signal frequency is 1 Hz or less. The lead angle is also deactivated in detecting of reverse rotation.

4. Lead Angle Control

The lead angle can be adjusted between 0° and 58° according to the induced voltage level on the LA input.

SS=L

LA analog input (0 to 5 V in 32 separate steps.)

0 V = 0°

5 V = 58° (A lead angle of 58° is assumed when the LA voltage exceeds 5 V.)

SS=H

LA analog input (0 to 5 V in 16 separate steps.)

0 V = 0°

5 V = 28° (A lead angle of 28° is assumed when the LA voltage exceeds 5 V.)

5. PWM Carrier Frequency

The triangular waveform generator provides a carrier frequency of $f_{osc}/252$ necessary for PWM generation. (The triangular wave is also used to force the switch-on of low-side transistors during square-wave drive.)

Carrier frequency: $F_C = f_{osc}/252$ (Hz),
 where f_{osc} = reference clock (crystal oscillator) frequency

6. Position Detecting Pin

<Hall device input>

V_W is 0.5 to 4.0 V in in-phase range. Input hysteresis voltage (V_H) is 7.5 mV (typ.).

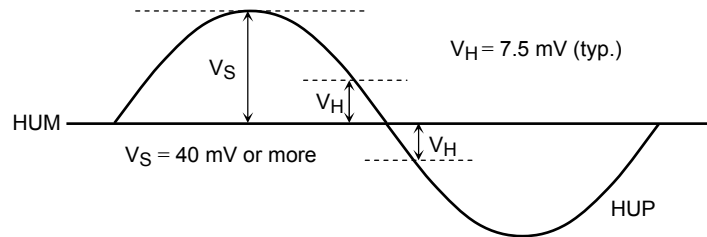

<Hall IC input>

Usage conditions: HUP, HVP, and HWP = GND to V_{refout}
 HUM, HVM, and HWM = $V_{refout} / 2$

7. Rotating Pulse Output

The TB67B000HG outputs rotating pulse based on hall signal. FGC terminal can switch one pulse per electrical angle or 3 pulses per electrical angle. One pulse per electrical angle is generated from hall signal of U phase. 3 pulses per electrical angle are generated by combining each rising and falling edge of U, V, and W phases.

When the pulse is outputted at 2.4 pulses per electrical angle (FGC=M), FG terminal outputs L level under the condition that the direction of motor rotating is forward or reverse at 1Hz or less. It is outputted regardless of the input voltage of V_{sp} .

FGC	FG
High	1 pulse per electrical angle
Middle	2.4 pulse per electrical angle (2 pulse per 5/6 electrical angle)
Low	3 pulses per electrical angle

Timing Chart of FG Signal

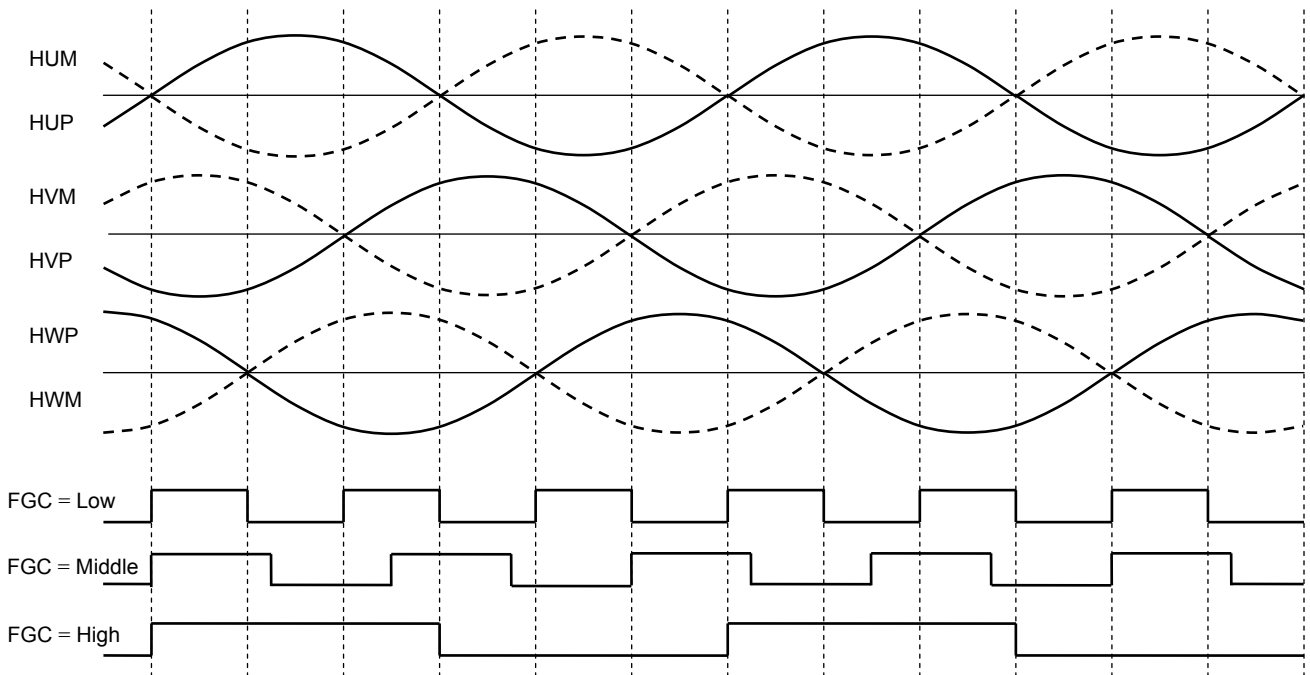

8. Protection-Related Input Pins

(1) Overcurrent protection (I_{dc} pin)

If the voltage of the DC-link current exceeds the internal reference voltage, the gate block is activated and the commutation signals (U, V, and W) are forced Low. Overcurrent protection is disabled after every carrier period under the condition that the voltage is 0.5 (typ.).

Reference voltage = 0.5 V (typ.)

(2) Abnormal position signal protection

When the position detection signals (internal hall sensor outputs) are all Highs or all Lows, or position input signals (HUP, HUM, HVP, HVM, HWP, and HWM) are all open, the commutation outputs (U, V, and W) are forced off. When these inputs are then set to any other combination, the commutation outputs are re-enabled.

(3) Undervoltage lockout (V_{CC})

While the power supply voltage is outside the rated range during power-on or power-off, the commutation outputs (U, V, and W) are set to the high-impedance state to prevent external power elements from damage due to short-circuits.

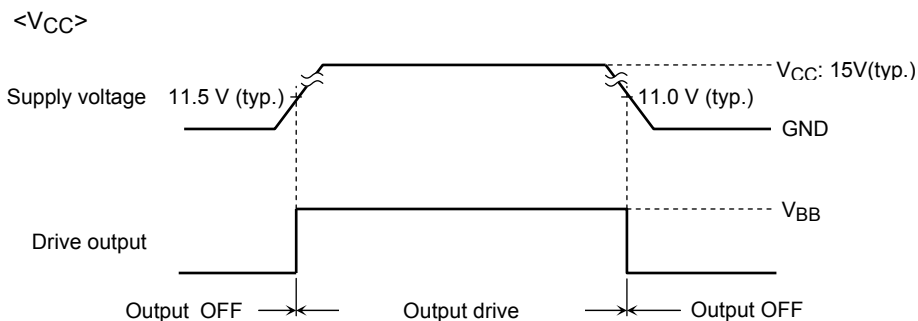

- (4) Monitor for V_{BS} bootstrap power supply
 When V_{BS} power supply falls, high-side of IGBT output is turned off.

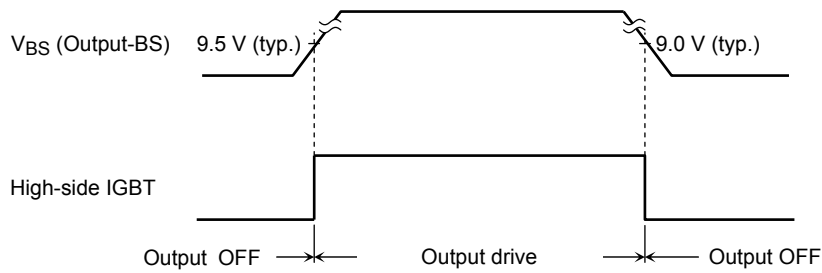

- (5) Thermal shutdown circuit
 When chip temperature rises high abnormally because of internal or external heat generation, all outputs of IGBT are tuned off.

$T_{SD} = 135(\text{min.}), 185^{\circ}\text{C}(\text{max.}) \quad T_{SDhys} = 50^{\circ}\text{C}(\text{typ.})$

Recovery temperature after TSD: $T_{SD} - T_{SDhys}$

9. Motor-lock detection

When hall signal detects below state, intermitted operation (drive period: stop period = 1: 6) is repeated.

<Description of motor-lock detection>

Motor lock detection starts counting (drive period) when V_{SP} exceeds 2.1 V. When direction of motor rotation and setting direction are the same (forward direction: sine-wave PWM mode or wide-angle commutation mode), lock detection drives with 120° commutation (square-wave drive) under the condition that frequency of the hall signal is about 1 Hz or less (when $f_{osc} = 5\text{MHz}$).

When direction of motor rotation is opposed against setting direction (reverse direction: 120° commutation mode of reverse hall input), lock detection drives under the condition that frequency of the hall signal is about 5 Hz or less (when $f_{osc} = 5\text{MHz}$).

When lock detection enables, operation is turned off (output drive is OFF) during stop period.

When V_{SP} is set 1.0 V or less, counter is reset and remove stop state. Then, when V_{SP} is set 2.1 V or more again, counter starts counting from initial state.

Table of lock detection

CW/CCW pin	V_{sp} pin > 2.1V		V_{sp} pin \leq 2.1V
	Direction of motor rotation		
	CW	CCW	
High(CW)	$f_{osc} \leq 1\text{Hz}$ (Rotating direction: set of CW/CCW pin = motor)	$f_{osc} \leq 5\text{Hz}$ (Rotating direction: set of CW/CCW pin \neq motor)	Inactive
Low(CCW)	$f_{osc} \leq 5\text{Hz}$ (Rotating direction: set of CW/CCW pin \neq motor)	$f_{osc} \leq 1\text{Hz}$ (Rotating direction: set of CW/CCW pin = motor)	Inactive

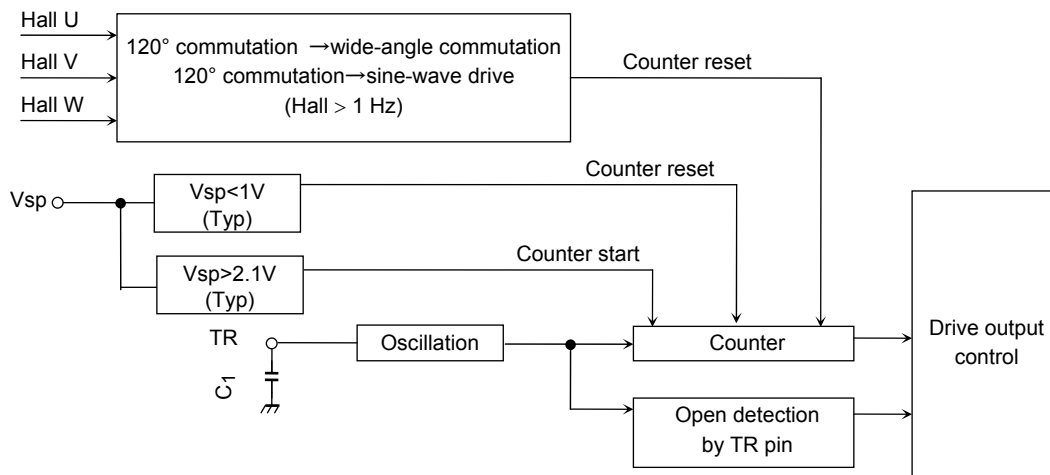

<Setting method>

Time of detection and stop outputting can be determined by an external capacitor (C_1) of TR pin.

· Setting period

$$\text{Drive period } T_{on}[s] = C_1 \times (V_H - V_L) \times 2/I \times 500 \text{ counts}$$

$$\text{Stop period } T_{off}[s] = C_1 \times (V_H - V_L) \times 2/I \times 3000 \text{ counts (Note 1)}$$

- Ex.: When $C_1 = 0.01\mu\text{F}$, $I = 3\mu\text{A}$ (typ.), $V_H = 2\text{V}$ (typ.) and $V_L = 0.5\text{V}$ (typ.), and then $T_{on}[s] = 5\text{s}$ (typ.) and $T_{off}[s] = 30\text{s}$ (typ.).

Note 1: Bootstrap capacitor does not charge (refresh) during stop period.

To charge bootstrap capacitor in recovery, V_{sp} should be set as follows by voltage command input; $1.0\text{V} < V_{sp} \leq 2.1\text{V}$.

Note 2: When TR pin is open, the operation moves to stop mode (drive output OFF) by open detection.

Note 3: Counter is not activated by applying fixed voltage (GND) to the TR pin. And motor lock detection is turned off and drive mode can be continued.

Timing Chart

CW/CCW	SS	Hall input (frequency)	Drive method	No.	
H	H	CW (1Hz or less)	Square-wave drive (120° commutation)	5	
		CW (1Hz or higher)	Wide-angle commutation (150° commutation)	3	
		CCW	Square-wave drive (120° commutation)	6	
	L	L	CW (1Hz or less)	Square-wave drive (120° commutation)	5
			CW (1Hz or higher)	Sine-wave PWM drive (180° commutation)	1
			CCW	Square-wave drive (120° commutation)	6
L	H	CW	Square-wave drive (120° commutation)	8	
		CCW (1Hz or less)	Square-wave drive (120° commutation)	7	
		CCW (1Hz or higher)	Wide-angle commutation (150° commutation)	4	
	L	L	CW	Square-wave drive (120° commutation)	8
			CCW (1Hz or less)	Square-wave drive (120° commutation)	7
			CCW (1Hz or higher)	Sine-wave PWM drive (180° commutation)	2

Timing Chart 1: Output waveform of sine-wave PWM drive
(CW/CCW = High, SS = Low, LA = GND, Noninverted hall signal inputs)

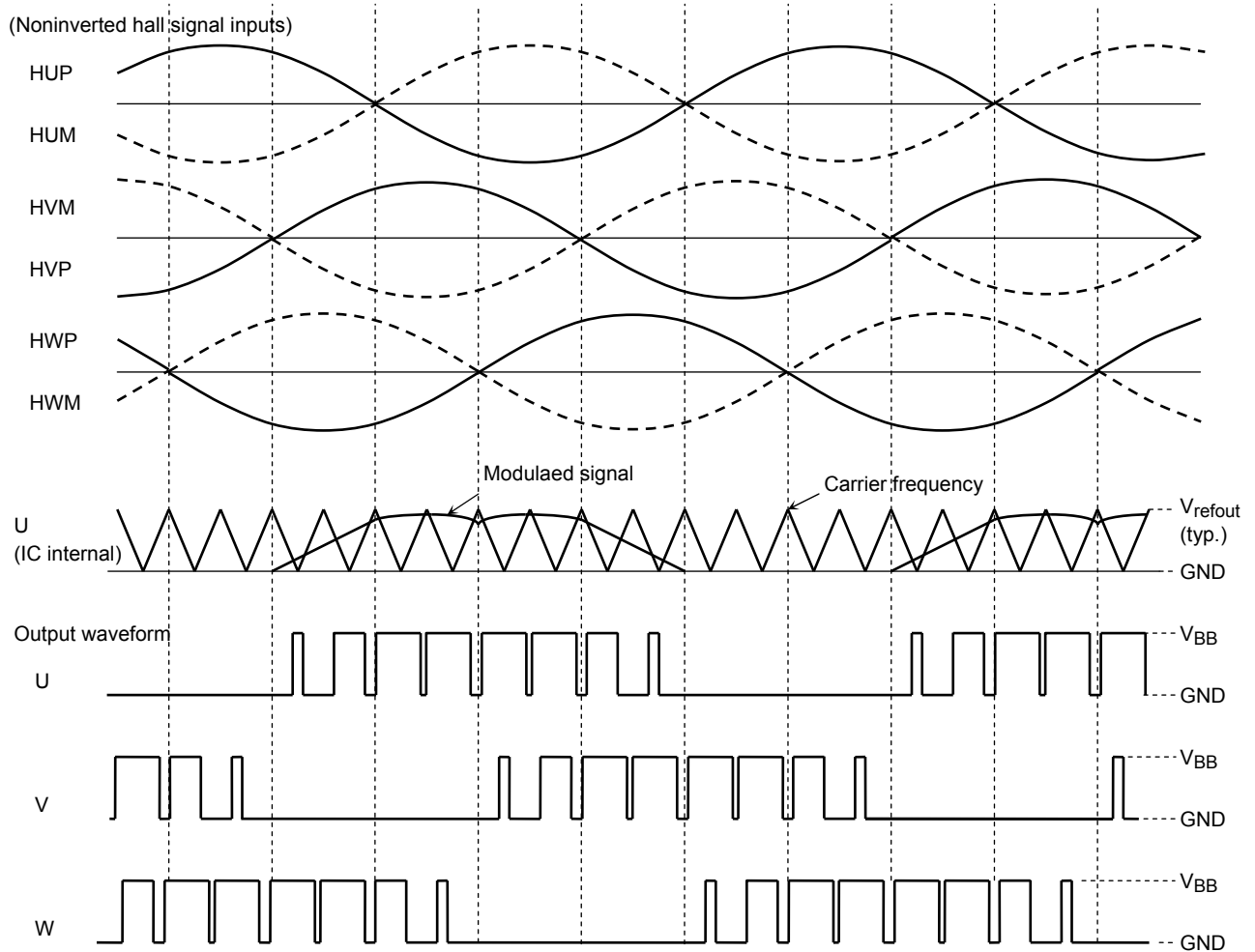

Note: The above timing chart is simplified to illustrate the function and behavior of the device.

**Timing Chart 2: Output waveform of sine-wave PWM drive
(CW/CCW = Low, SS = Low, LA = GND, Inverted hall signal inputs)**

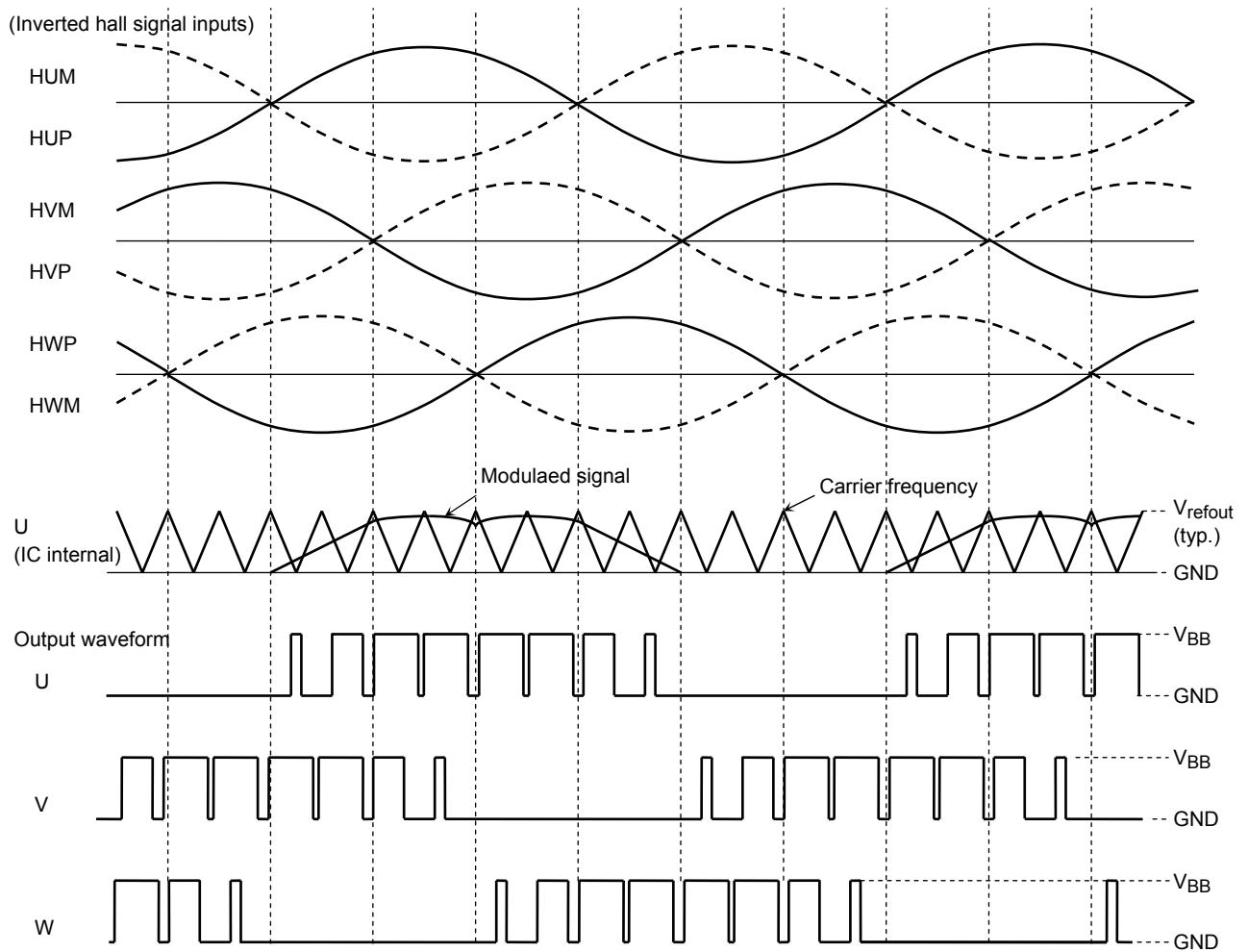

Note: The above timing chart is simplified to illustrate the function and behavior of the device.

Timing Chart 3: Output waveform of wide-angle commutation
 (CW/CCW = High, SS = High, LA = GND, Noninverted hall signal inputs)

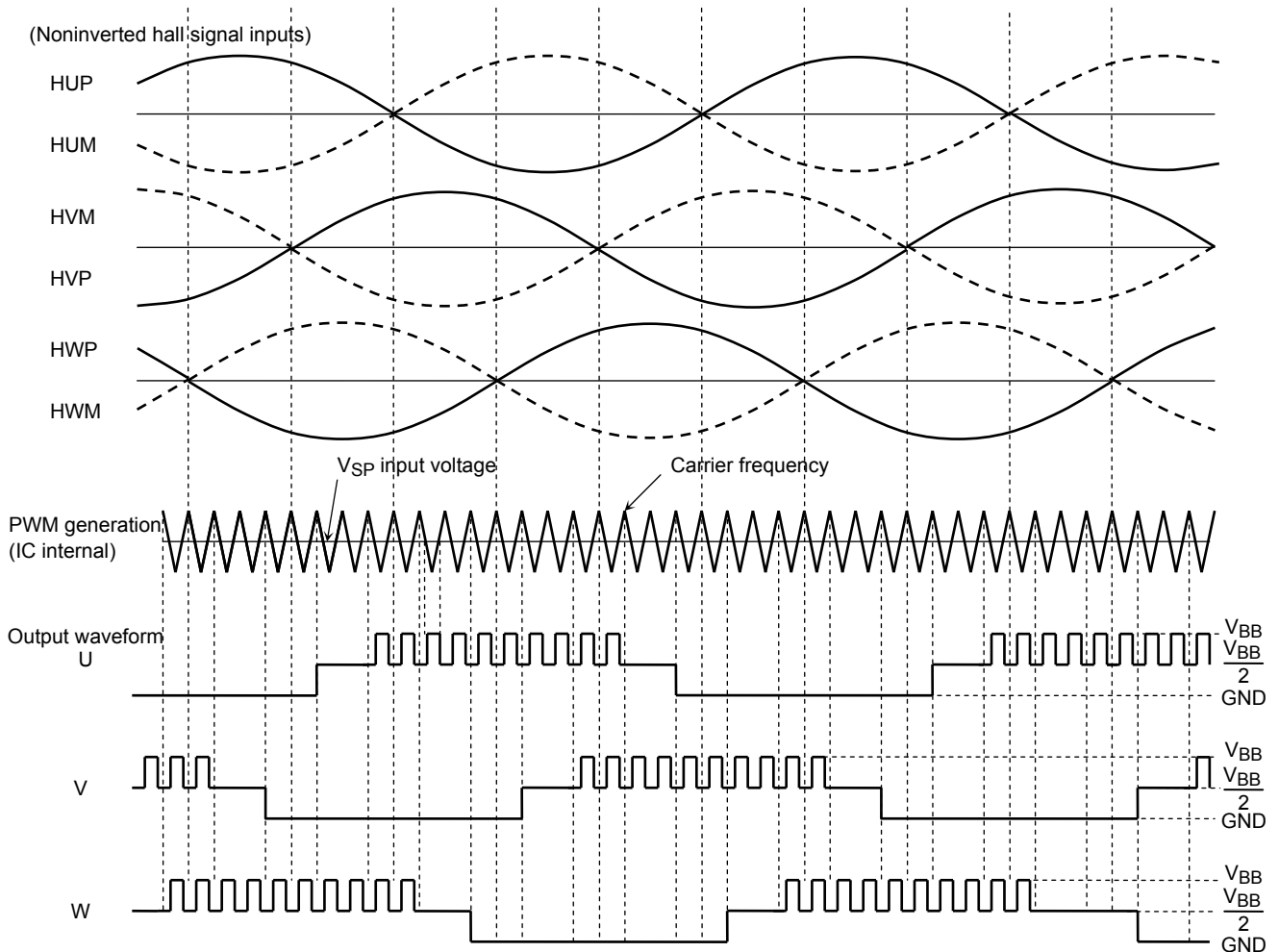

Note: The above timing chart is simplified to illustrate the function and behavior of the device.

The above U-phase waveform shows the behavior of the U-phase output signal when a resistor is connected between the U and VM pins and also between the U pin and ground to obtain $\frac{V_{BB}}{2}$. Likewise, resistors are connected to the V and W pins. $\frac{V_{BB}}{2}$ indicates the high-impedance state.

**Timing Chart 4: Output waveform of wide-angle commutation
(CW/CCW = Low, SS=High, LA = GND, Inverted hall signal inputs)**

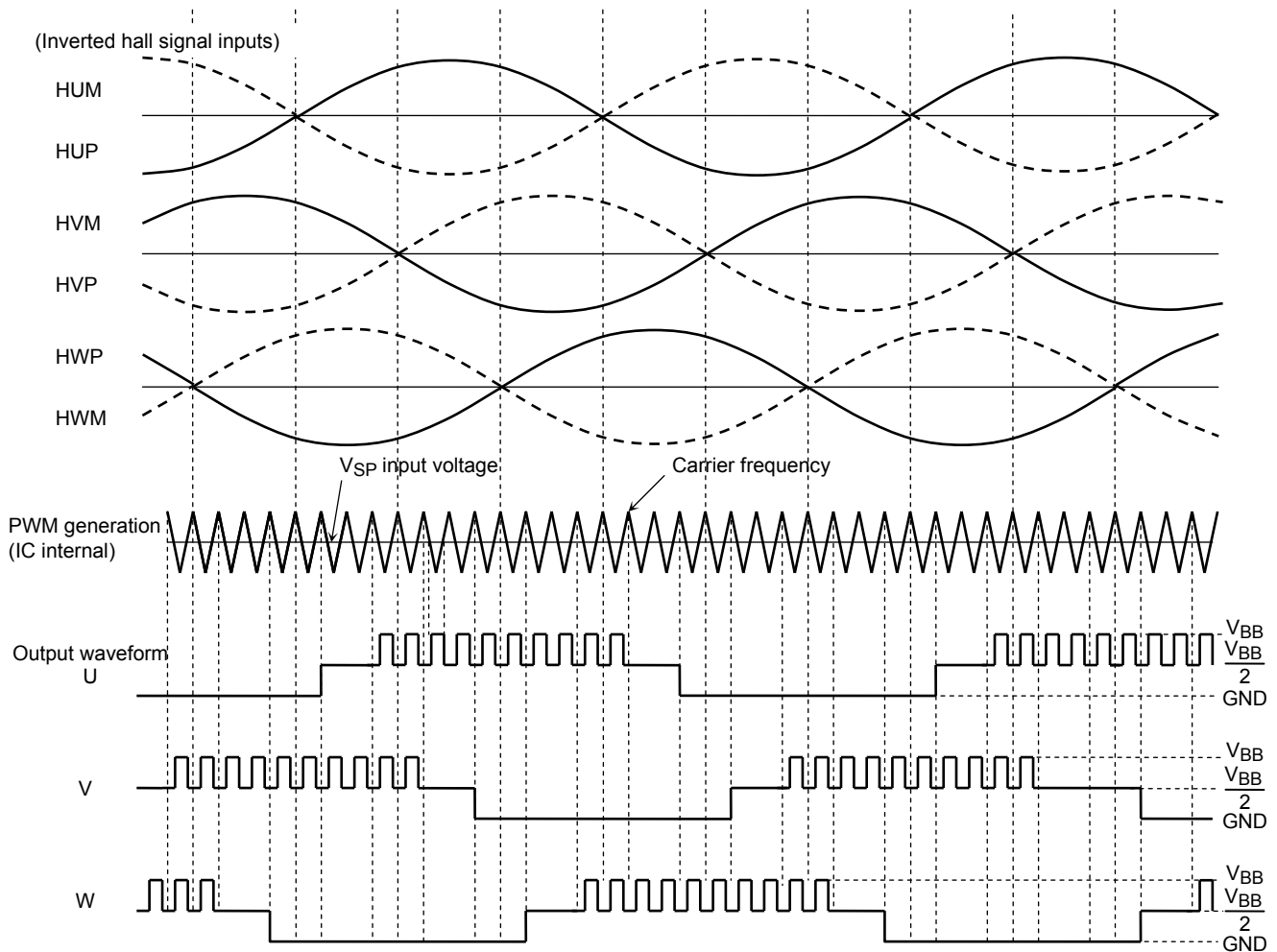

Note: The above timing chart is simplified to illustrate the function and behavior of the device.

The above U-phase waveform shows the behavior of the U-phase output signal when a resistor is connected between the U and VM pins and also between the U pin and ground to obtain $\frac{V_{BB}}{2}$. Likewise, resistors are connected to the V and W pins. $\frac{V_{BB}}{2}$ indicates the high-impedance state.

**Timing Chart 5: Output waveform of square-wave drive
(CW/CCW = High, LA = GND, Noninverted hall signal inputs)**

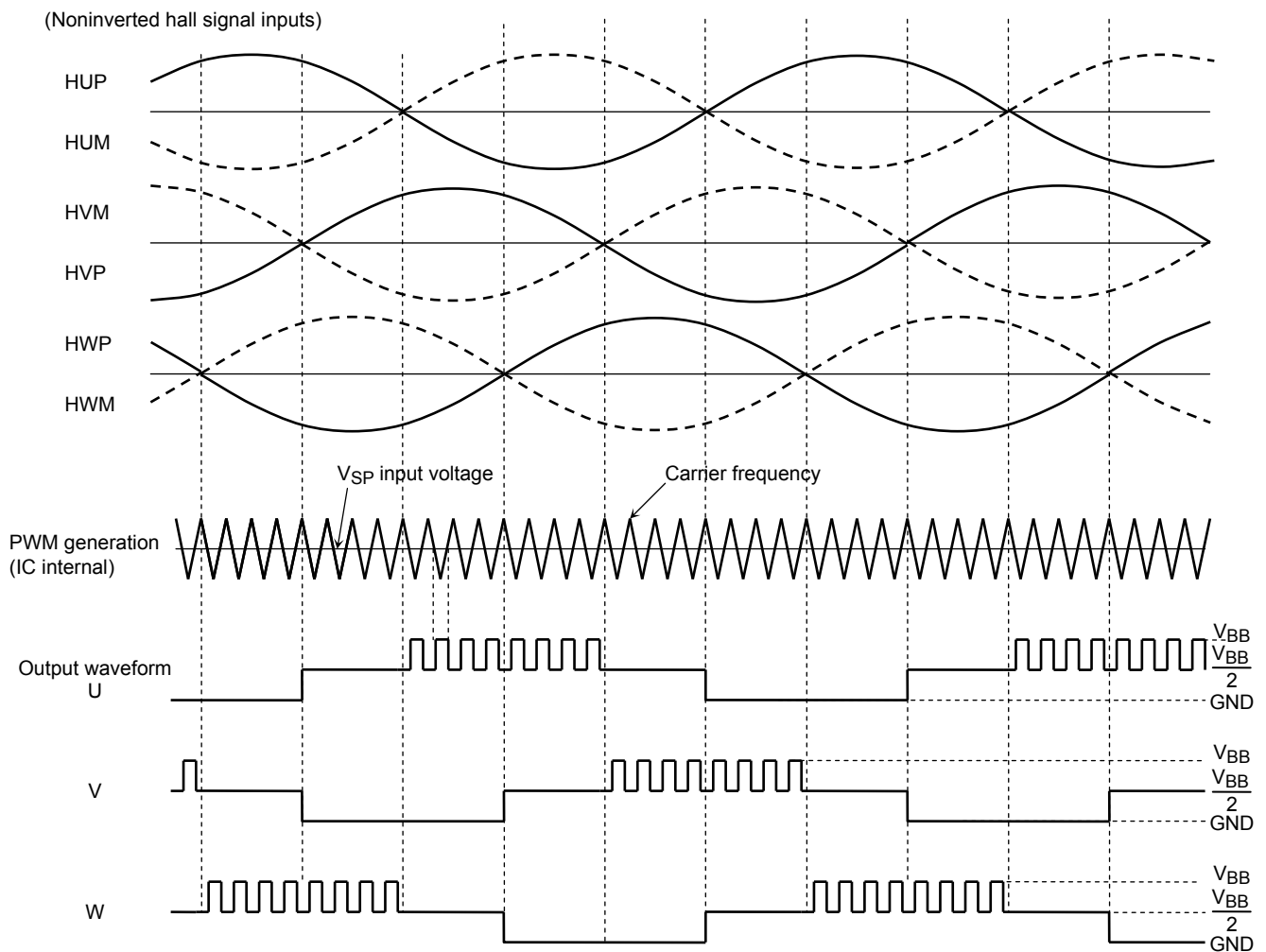

Note: The above timing chart is simplified to illustrate the function and behavior of the device.

The above U-phase waveform shows the behavior of the U-phase output signal when a resistor is connected between the U and VM pins and also between the U pin and ground to obtain $\frac{V_{BB}}{2}$. Likewise, resistors are connected to the V and W pins. $\frac{V_{BB}}{2}$ indicates the high-impedance state.

Timing Chart 6: Output waveform of square-wave drive
 (CW/CCW = High, LA = GND, Inverted hall signal inputs)

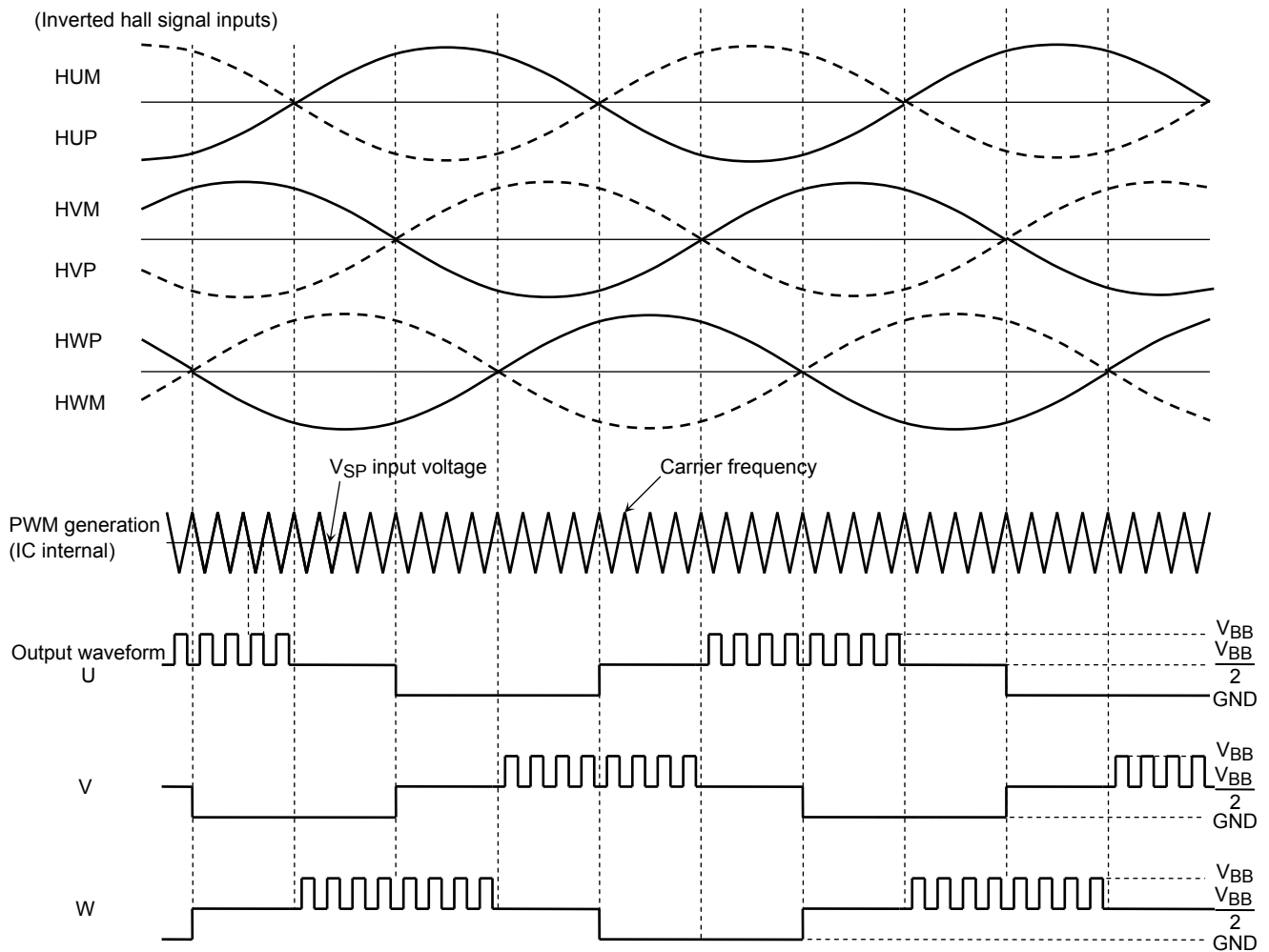

Note: The above timing chart is simplified to illustrate the function and behavior of the device.

The above U-phase waveform shows the behavior of the U-phase output signal when a resistor is connected between the U and VM pins and also between the U pin and ground to obtain $\frac{V_{BB}}{2}$. Likewise, resistors are connected to the V and W pins. $\frac{V_{BB}}{2}$ indicates the high-impedance state.

**Timing Chart 7: Output waveform of square-wave drive
(CW/CCW = Low, LA = GND, Inverted hall signal inputs)**

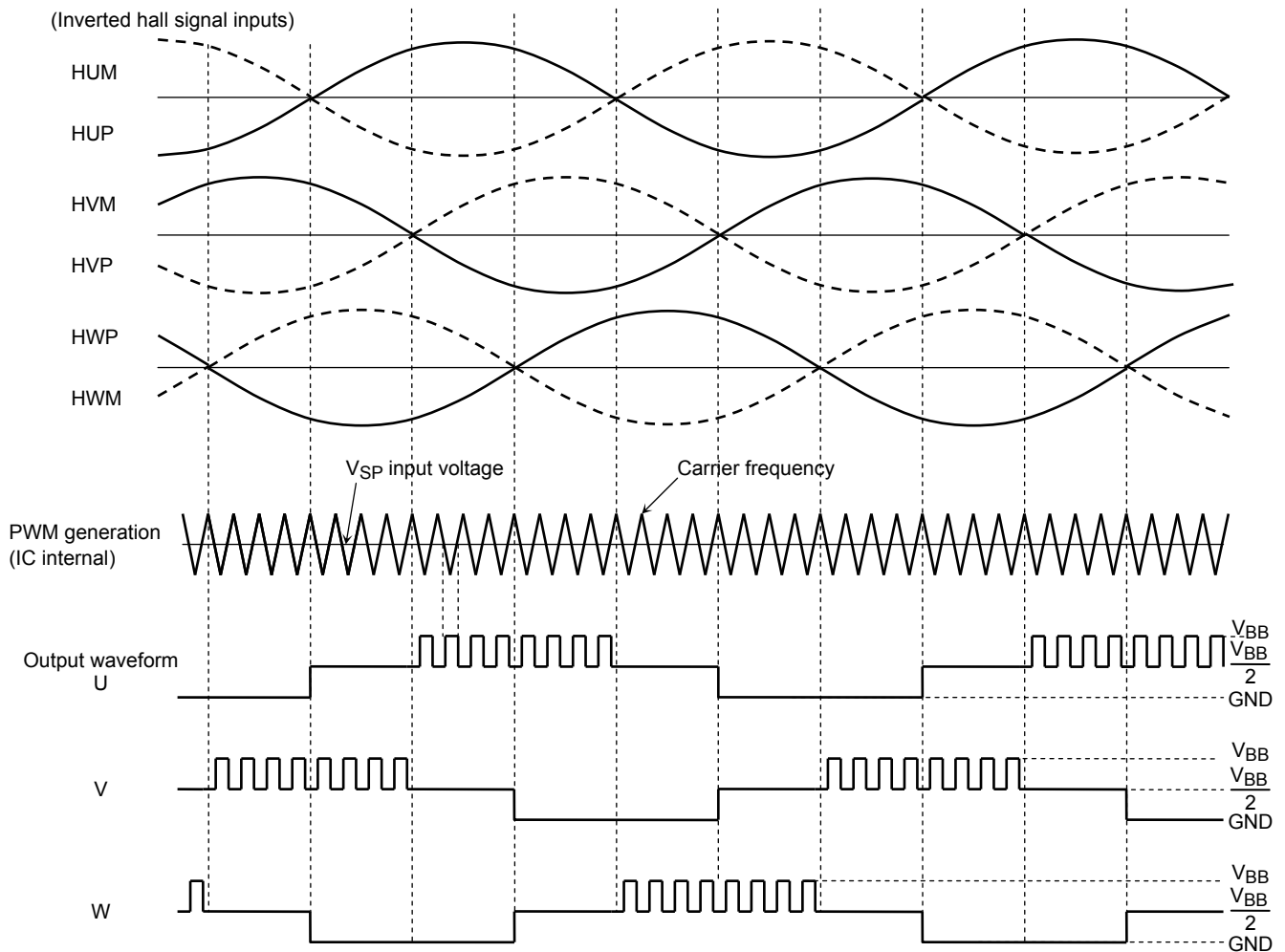

Note: The above timing chart is simplified to illustrate the function and behavior of the device.

The above U-phase waveform shows the behavior of the U-phase output signal when a resistor is connected between the U and VM pins and also between the U pin and ground to obtain $\frac{V_{BB}}{2}$. Likewise, resistors are connected to the V and W pins. $\frac{V_{BB}}{2}$ indicates the high-impedance state.

**Timing Chart 8: Output waveform of square-wave drive
(CW/CCW = Low, LA = GND, Noninverted hall signal inputs)**

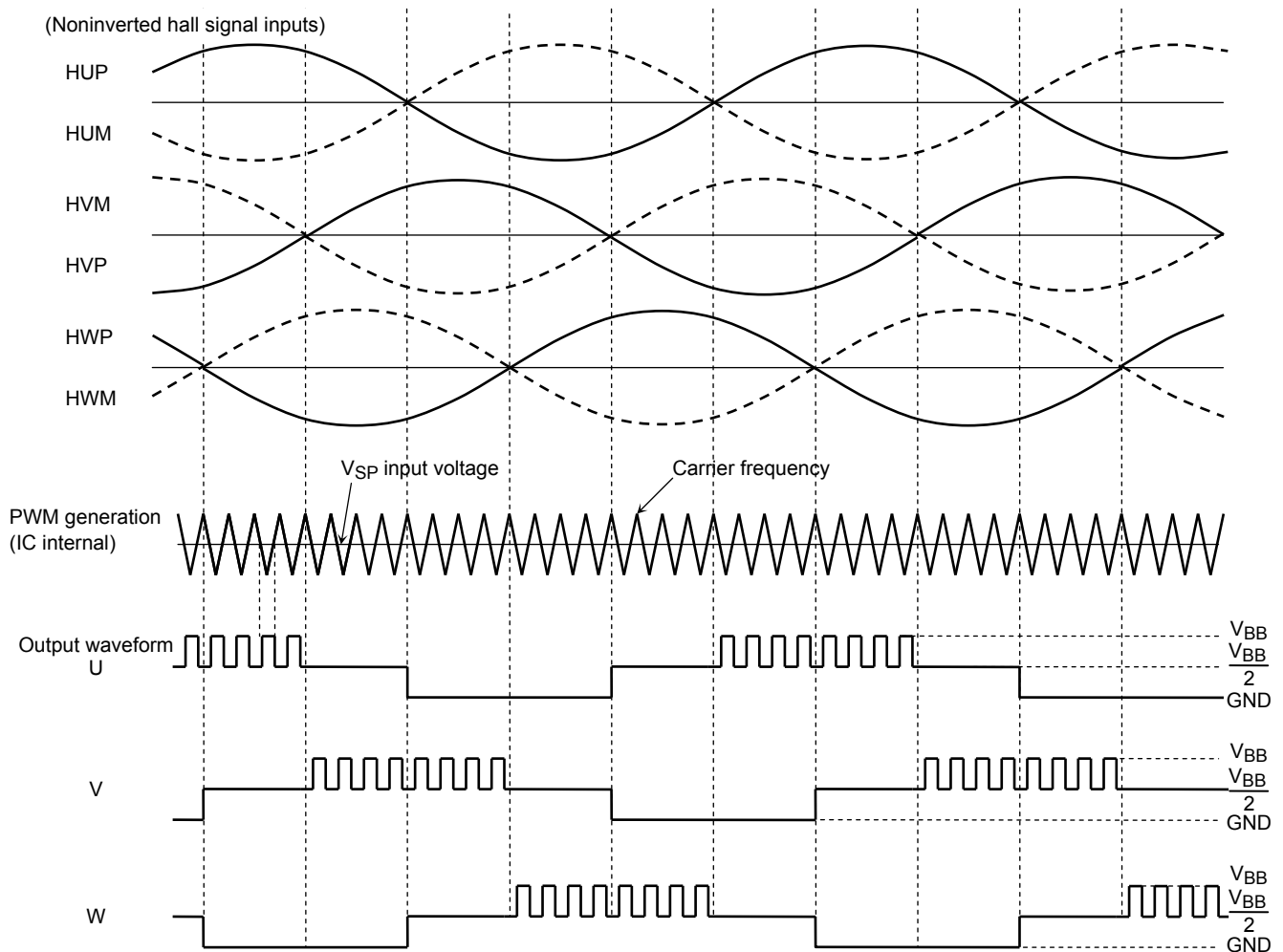

Note: The above timing chart is simplified to illustrate the function and behavior of the device.

The above U-phase waveform shows the behavior of the U-phase output signal when a resistor is connected between the U and VM pins and also between the U pin and ground to obtain $\frac{V_{BB}}{2}$. Likewise, resistors are connected to the V and W pins. $\frac{V_{BB}}{2}$ indicates the high-impedance state.

Application Circuit

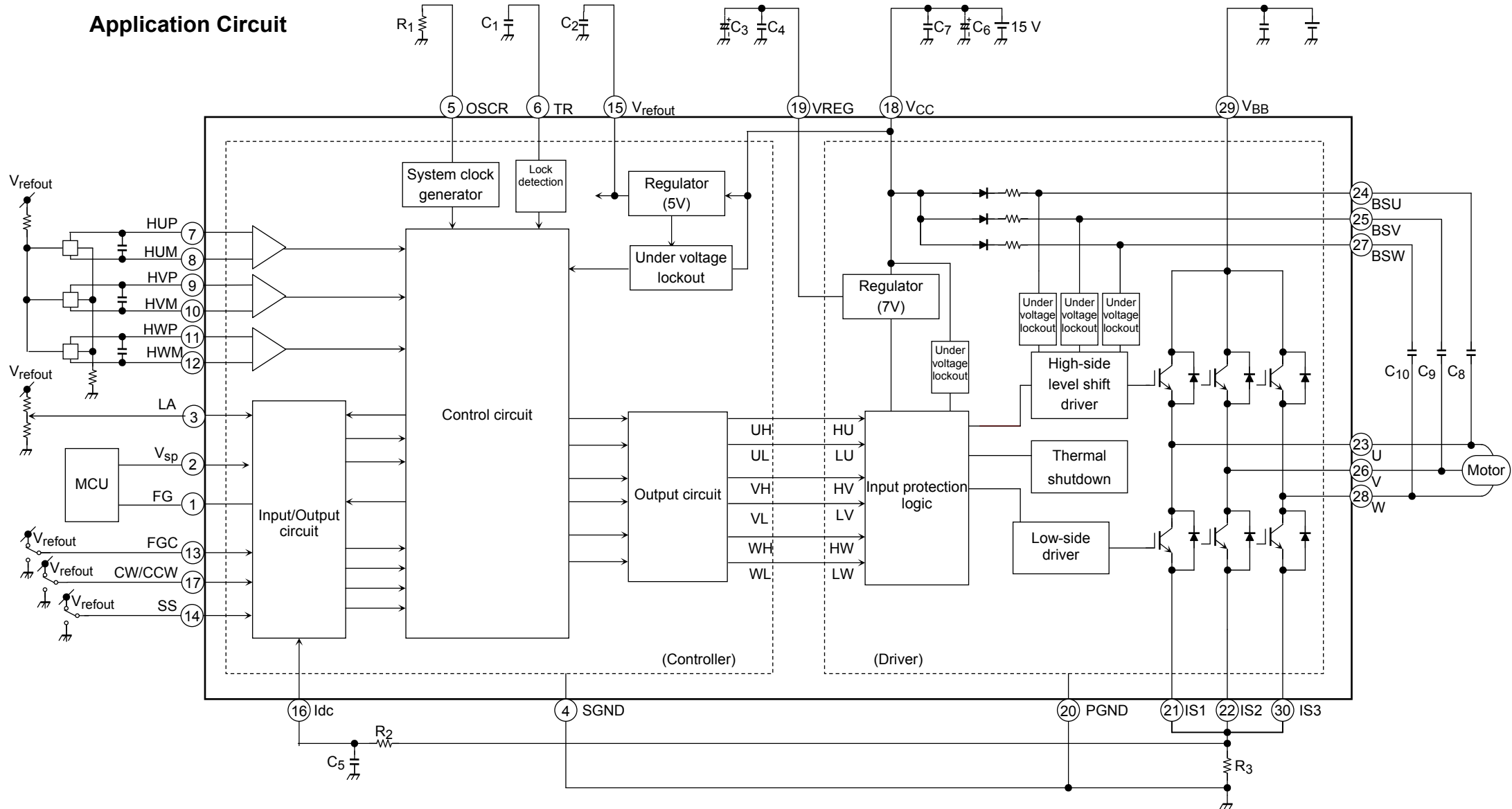

Utmost care is necessary in the design of board layout since the IC may be destroyed and cause smoke or ignition by short-circuiting between outputs, air contamination faults, or faults due to improper grounding, or by short-circuiting between contiguous pins. Specially, in the design of the output, V_{BB}, U, V, W, IS1, IS2, IS3 and GND lines which have high voltage and high current, utmost care is necessary. Add overcurrent protection such as a fuse not to allow large current continuing to flow in case of over current generation or IC breakdown.

External Parts

Symbol	Purpose	Recommended value	Note
R ₁	Internal clock generation	68 kΩ	(Note 1)
C ₁	Motor lock detection	10 V / 0.01 μF	(Note 2)
C ₂	V _{refout} oscillation protection	10 V / 0.1 μF to 1.0 μF	(Note 3)
C ₃	V _{REG} power supply stability	25 V / 1 μF	(Note 3)
C ₄		25 V / 1000 pF	
C ₅	Noise absorber	10 V / 1000pF	(Note 4)
R ₂		5.1 kΩ	
R ₃	Overcurrent detection	0.62 Ω ± 1% (1 W)	(Note 5)
C ₆	V _{CC} power supply stability	25 V / 10 μF	(Note 3)
C ₇		25 V / 0.1 μF	
C ₈ , C ₉ , C ₁₀	Bootstrap capacitor	25 V / 2.2 μF	(Note 6)

Note 1: For carrier frequency and dead time, determine the resistor to set the oscillation frequency of 6.4 MHz or less.

Note 2: This part sets the output stop period and output drive period of motor lock detection. When this function is not used, connect it to GND. As for detailed descriptions, please refer to the section of "Motor Lock Detection" in this document.

Note 3: This part is used as a capacitor for power supply stability. Adjust the part to the application environment as required. When mounting, place it as close as possible to the base of the leads of this product to improve the noise elimination.

Note 4: These parts are used as a low-pass filter for noise absorption. Test to confirm noise filtering, then set the filter time-constant.

Note 5: This part is used to set the value for overcurrent detection. $I_{out(max)} = V_{dc} \div R_3$ ($V_{dc} = 0.5$ V (typ.))

Note 6: The required bootstrap capacitance value varies according to the motor drive conditions. The voltage stress for the capacitor is the value of V_{CC}.

Package Dimensions

Unit: mm

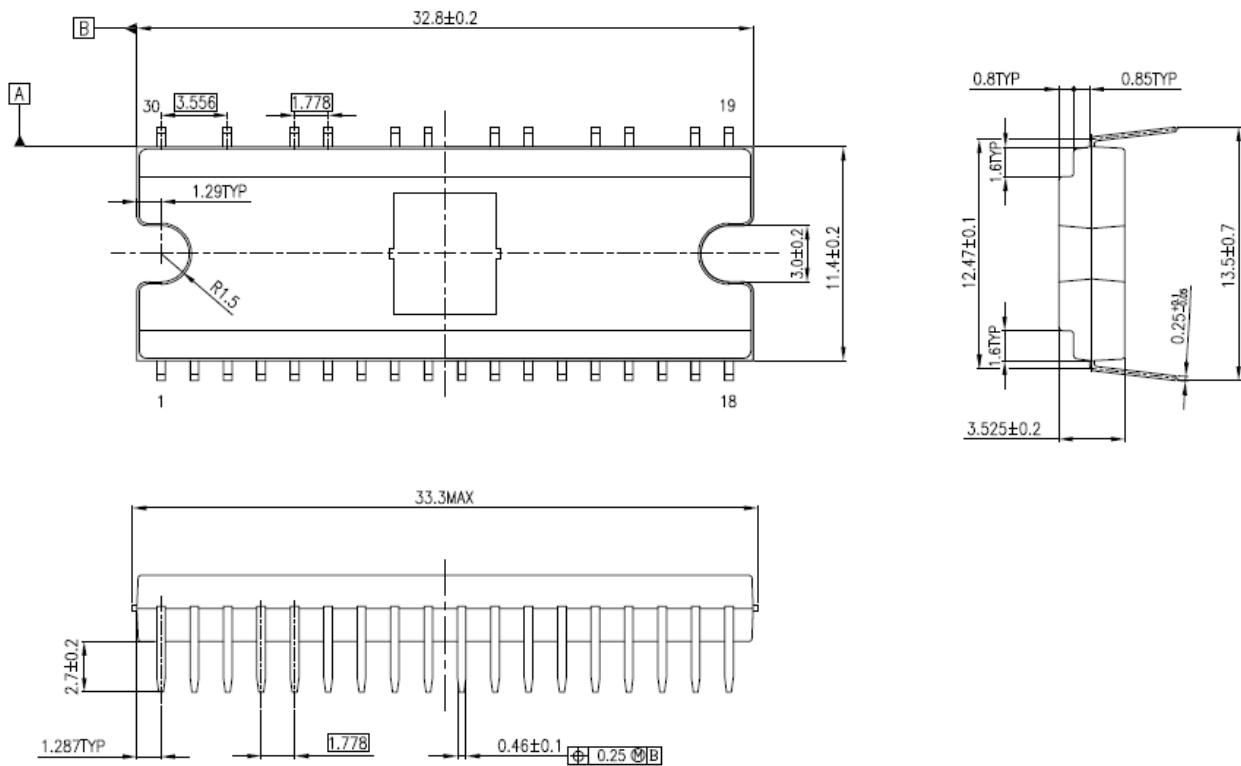

Weight: 2.59 g (typ.)

Note: Die pad on surface and PGND is connected. When using the heat sink, handle it not to short with the IC terminals. When applying the different potential with GND level to the heat sink, insulate with die pad and the heat sink.

Notes on Contents

1. Block Diagrams

Some of the functional blocks, circuits, or constants in the block diagram may be omitted or simplified for explanatory purposes.

2. Equivalent Circuits

The equivalent circuit diagrams may be simplified or some parts of them may be omitted for explanatory purposes.

3. Timing Charts

Timing charts may be simplified for explanatory purposes.

4. Application Circuits

The application circuits shown in this document are provided for reference purposes only. Thorough evaluation is required, especially at the mass production design stage.

Toshiba does not grant any license to any industrial property rights by providing these examples of application circuits.

5. Test Circuits

Components in the test circuits are used only to obtain and confirm the device characteristics. These components and circuits are not guaranteed to prevent malfunction or failure from occurring in the application equipment.

IC Usage Considerations

Notes on handling of ICs

[1] The absolute maximum ratings of a semiconductor device are a set of ratings that must not be exceeded, even for a moment. Do not exceed any of these ratings.

Exceeding the rating(s) may cause the device breakdown, damage or deterioration, and may result injury by explosion or combustion.

[2] Use an appropriate power supply fuse to ensure that a large current does not continuously flow in case of over current and/or IC failure. The IC will fully break down when used under conditions that exceed its absolute maximum ratings, when the wiring is routed improperly or when an abnormal pulse noise occurs from the wiring or load, causing a large current to continuously flow and the breakdown can lead smoke or ignition. To minimize the effects of the flow of a large current in case of breakdown, appropriate settings, such as fuse capacity, fusing time and insertion circuit location, are required.

[3] If your design includes an inductive load such as a motor coil, incorporate a protection circuit into the design to prevent device malfunction or breakdown caused by the current resulting from the inrush current at power ON or the negative current resulting from the back electromotive force at power OFF. IC breakdown may cause injury, smoke or ignition.

Use a stable power supply with ICs with built-in protection functions. If the power supply is unstable, the protection function may not operate, causing IC breakdown. IC breakdown may cause injury, smoke or ignition.

[4] Do not insert devices in the wrong orientation or incorrectly.

Make sure that the positive and negative terminals of power supplies are connected properly.

Otherwise, the current or power consumption may exceed the absolute maximum rating, and exceeding the rating(s) may cause the device breakdown, damage or deterioration, and may result injury by explosion or combustion.

In addition, do not use any device that is applied the current with inserting in the wrong orientation or incorrectly even just one time. Utmost care is necessary in the design of board layout since the IC may be destroyed and cause smoke or ignition by short-circuiting between outputs, air contamination faults, or faults due to improper grounding, or by short-circuiting between contiguous pins. Specially, in the design of the output, V_{BB} , U, V, W, IS1, IS2, IS3 and GND lines which have high voltage and high current, utmost care is necessary.

[5] Die pad on surface and PGND is connected.

When using the heat sink, handle it not to short with the IC terminals. When applying the different potential with GND level to the heat sink, insulate with die pad and the heat sink.

Points to remember on handling of ICs**(1) Over current Protection Circuit**

Over current protection circuits (referred to as current limiter circuits) do not necessarily protect ICs under all circumstances. If the over current protection circuits operate against the over current, clear the over current status immediately.

Depending on the method of use and usage conditions, such as exceeding absolute maximum ratings can cause the over current protection circuit to not operate properly or IC breakdown before operation. In addition, depending on the method of use and usage conditions, if over current continues to flow for a long time after operation, the IC may generate heat resulting in breakdown.

(2) Thermal Shutdown Circuit

Thermal shutdown circuits do not necessarily protect ICs under all circumstances. If the thermal shutdown circuits operate against the over temperature, clear the heat generation status immediately.

Depending on the method of use and usage conditions, such as exceeding absolute maximum ratings can cause the thermal shutdown circuit to not operate properly or IC breakdown before operation.

(3) Heat Radiation Design

In using an IC with large current flow such as power amp, regulator or driver, please design the device so that heat is appropriately radiated, not to exceed the specified junction temperature (T_j) at any time and condition. These ICs generate heat even during normal use. An inadequate IC heat radiation design can lead to decrease in IC life, deterioration of IC characteristics or IC breakdown. In addition, please design the device taking into consideration the effect of IC heat radiation with peripheral components.

(4) Back-EMF

When a motor rotates in the reverse direction, stops or slows down abruptly, a current flow back to the motor's power supply due to the effect of back-EMF. If the current sink capability of the power supply is small, the device's motor power supply and output pins might be exposed to conditions beyond absolute maximum ratings. To avoid this problem, take the effect of back-EMF into consideration in system design.

RESTRICTIONS ON PRODUCT USE

- Toshiba Corporation, and its subsidiaries and affiliates (collectively "TOSHIBA"), reserve the right to make changes to the information in this document, and related hardware, software and systems (collectively "Product") without notice.
- This document and any information herein may not be reproduced without prior written permission from TOSHIBA. Even with TOSHIBA's written permission, reproduction is permissible only if reproduction is without alteration/omission.
- Though TOSHIBA works continually to improve Product's quality and reliability, Product can malfunction or fail. Customers are responsible for complying with safety standards and for providing adequate designs and safeguards for their hardware, software and systems which minimize risk and avoid situations in which a malfunction or failure of Product could cause loss of human life, bodily injury or damage to property, including data loss or corruption. Before customers use the Product, create designs including the Product, or incorporate the Product into their own applications, customers must also refer to and comply with (a) the latest versions of all relevant TOSHIBA information, including without limitation, this document, the specifications, the data sheets and application notes for Product and the precautions and conditions set forth in the "TOSHIBA Semiconductor Reliability Handbook" and (b) the instructions for the application with which the Product will be used with or for. Customers are solely responsible for all aspects of their own product design or applications, including but not limited to (a) determining the appropriateness of the use of this Product in such design or applications; (b) evaluating and determining the applicability of any information contained in this document, or in charts, diagrams, programs, algorithms, sample application circuits, or any other referenced documents; and (c) validating all operating parameters for such designs and applications. **TOSHIBA ASSUMES NO LIABILITY FOR CUSTOMERS' PRODUCT DESIGN OR APPLICATIONS.**
- **PRODUCT IS NEITHER INTENDED NOR WARRANTED FOR USE IN EQUIPMENTS OR SYSTEMS THAT REQUIRE EXTRAORDINARILY HIGH LEVELS OF QUALITY AND/OR RELIABILITY, AND/OR A MALFUNCTION OR FAILURE OF WHICH MAY CAUSE LOSS OF HUMAN LIFE, BODILY INJURY, SERIOUS PROPERTY DAMAGE AND/OR SERIOUS PUBLIC IMPACT ("UNINTENDED USE").** Except for specific applications as expressly stated in this document, Unintended Use includes, without limitation, equipment used in nuclear facilities, equipment used in the aerospace industry, medical equipment, equipment used for automobiles, trains, ships and other transportation, traffic signaling equipment, equipment used to control combustions or explosions, safety devices, elevators and escalators, devices related to electric power, and equipment used in finance-related fields. **IF YOU USE PRODUCT FOR UNINTENDED USE, TOSHIBA ASSUMES NO LIABILITY FOR PRODUCT.** For details, please contact your TOSHIBA sales representative.
- Do not disassemble, analyze, reverse-engineer, alter, modify, translate or copy Product, whether in whole or in part.
- Product shall not be used for or incorporated into any products or systems whose manufacture, use, or sale is prohibited under any applicable laws or regulations.
- The information contained herein is presented only as guidance for Product use. No responsibility is assumed by TOSHIBA for any infringement of patents or any other intellectual property rights of third parties that may result from the use of Product. No license to any intellectual property right is granted by this document, whether express or implied, by estoppel or otherwise.
- **ABSENT A WRITTEN SIGNED AGREEMENT, EXCEPT AS PROVIDED IN THE RELEVANT TERMS AND CONDITIONS OF SALE FOR PRODUCT, AND TO THE MAXIMUM EXTENT ALLOWABLE BY LAW, TOSHIBA (1) ASSUMES NO LIABILITY WHATSOEVER, INCLUDING WITHOUT LIMITATION, INDIRECT, CONSEQUENTIAL, SPECIAL, OR INCIDENTAL DAMAGES OR LOSS, INCLUDING WITHOUT LIMITATION, LOSS OF PROFITS, LOSS OF OPPORTUNITIES, BUSINESS INTERRUPTION AND LOSS OF DATA, AND (2) DISCLAIMS ANY AND ALL EXPRESS OR IMPLIED WARRANTIES AND CONDITIONS RELATED TO SALE, USE OF PRODUCT, OR INFORMATION, INCLUDING WARRANTIES OR CONDITIONS OF MERCHANTABILITY, FITNESS FOR A PARTICULAR PURPOSE, ACCURACY OF INFORMATION, OR NONINFRINGEMENT.**
- Do not use or otherwise make available Product or related software or technology for any military purposes, including without limitation, for the design, development, use, stockpiling or manufacturing of nuclear, chemical, or biological weapons or missile technology products (mass destruction weapons). Product and related software and technology may be controlled under the applicable export laws and regulations including, without limitation, the Japanese Foreign Exchange and Foreign Trade Law and the U.S. Export Administration Regulations. Export and re-export of Product or related software or technology are strictly prohibited except in compliance with all applicable export laws and regulations.
- Please contact your TOSHIBA sales representative for details as to environmental matters such as the RoHS compatibility of Product. Please use Product in compliance with all applicable laws and regulations that regulate the inclusion or use of controlled substances, including without limitation, the EU RoHS Directive. **TOSHIBA ASSUMES NO LIABILITY FOR DAMAGES OR LOSSES OCCURRING AS A RESULT OF NONCOMPLIANCE WITH APPLICABLE LAWS AND REGULATIONS.**