



PJ78L06SQ

3-Terminal Voltage Regulator

Features

- Input voltage: up to 30V
- Output: 6V
- Output current up to 100 mA, internal thermal overload protection and short-circuit limiting.

SOT-89

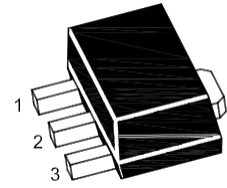

1. OUT 2. GND 3. IN

Maximum Ratings

Ratings at $T_A = 25^\circ\text{C}$ ambient temperature unless otherwise specified.

Parameter	Symbols	Value	Units
Input Voltage	V_I	30	V
Output Current	I_o	100	mA
Junction Temperature	T_J	150	$^\circ\text{C}$
Operating Temperature Range	T_{OPR}	-40~125	$^\circ\text{C}$
Power Dissipation	P_D	500	mW
Storage Temperature Range	T_{STG}	-55~150	$^\circ\text{C}$

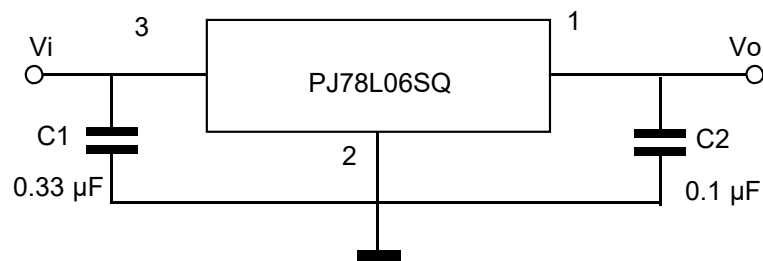



PJ78L06SQ

3-Terminal Voltage Regulator

Electrical Characteristics

Ratings at $T_A = 25^\circ\text{C}$ ambient temperature, $0^\circ\text{C} \leq T_J \leq 125^\circ\text{C}$ $V_I = 11\text{V}$, $I_O = 40\text{mA}$, $C_i = 0.33\mu\text{F}$, $C_o = 0.1\mu\text{F}$, unless otherwise specified.

Parameter	Symbols	Test Conditions	Min	Typ	Max	Unit
Output Voltage	V_O	$T_J = 25^\circ\text{C}$	5.76	6	6.24	V
		$I_O = 1\text{mA to } 40\text{mA}$ $V_I = 8.5\text{V to } 21\text{V}$	5.7	6	6.3	V
		$I_O = 1\text{mA to } 70\text{mA}$ $V_I = 11\text{V}$	5.7	6	6.3	V
Line Regulation	ΔV_O	$V_I = 8.5\text{V to } 21\text{V}$ $T_J = 25^\circ\text{C}$			155	mV
		$V_I = 9\text{V to } 21\text{V}$ $T_J = 25^\circ\text{C}$			105	mV
Load Regulation	ΔV_O	$I_O = 1\text{mA to } 100\text{mA}$, $T_J = 25^\circ\text{C}$			65	mV
		$I_O = 1\text{mA to } 40\text{mA}$, $T_J = 25^\circ\text{C}$			35	mV
Ripple Rejection	RR	$V_I = 9\text{V to } 19\text{V}$, $T_J = 25^\circ\text{C}$ $f = 120\text{Hz}$	40			dB
Output Noise Voltage	V_N	$f = 10\text{Hz} \sim 100\text{KHz}$ $T_J = 25^\circ\text{C}$		49		μV
Dropout Voltage	V_D	$T_J = 25^\circ\text{C}$		1.7		V
Quiescent Current	I_Q	$T_J = 25^\circ\text{C}$			5.5	mA
Quiescent Current Change	ΔI_Q	$V_I = 9\text{V to } 21\text{V}$, $I_O = 40\text{mA}$			1.5	mA
		$V_I = 11\text{V}$, $I_O = 1\text{mA to } 40\text{mA}$			0.1	mA



PJ78L06SQ

3-Terminal Voltage Regulator

Ratings and Characteristic Curves

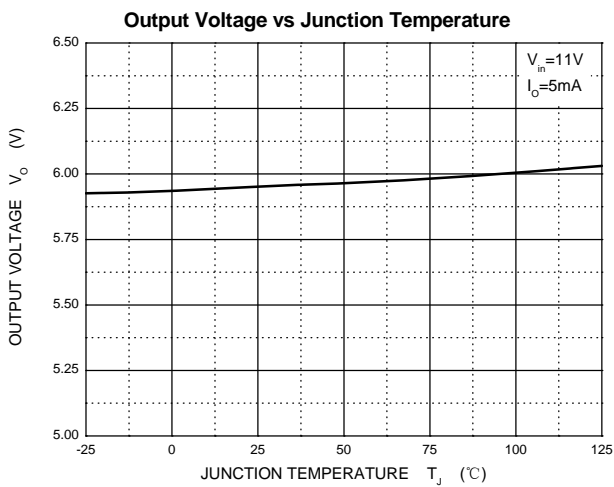
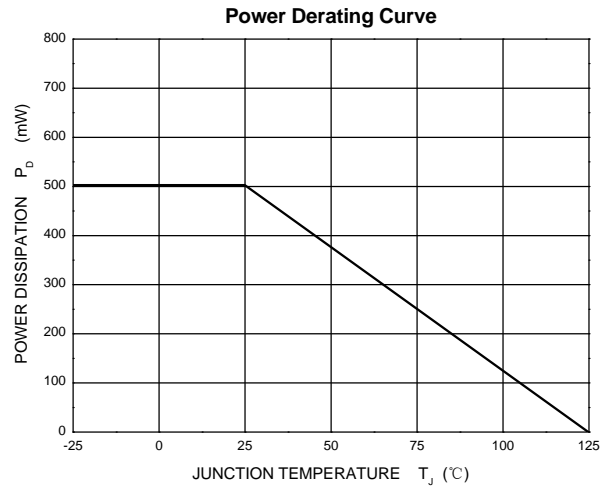
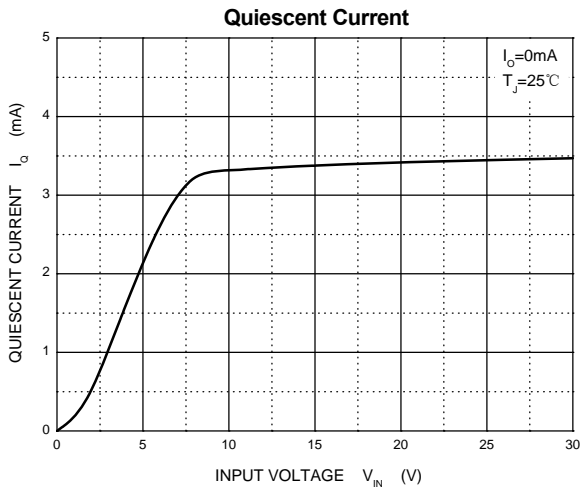
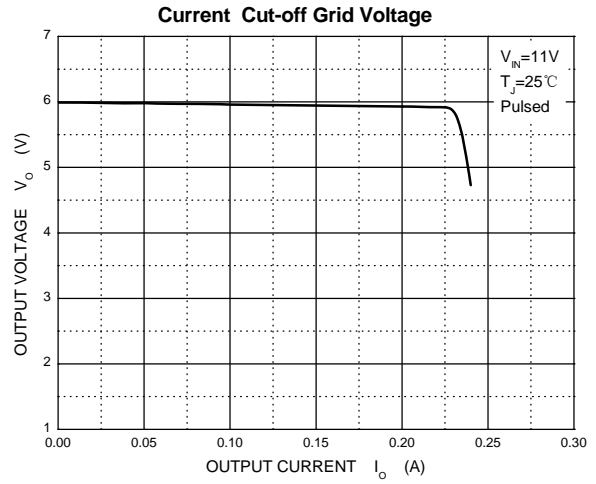
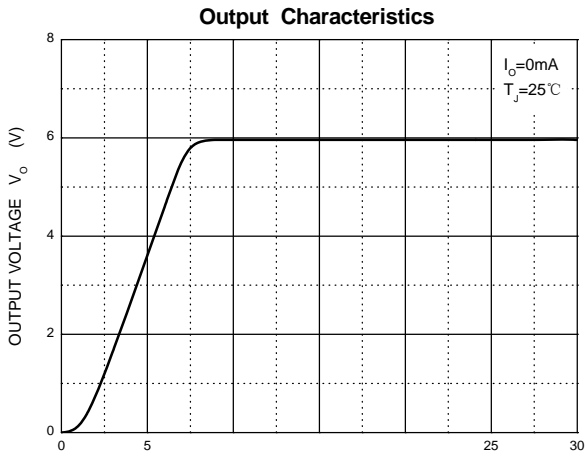



PJ78L06SQ

3-Terminal Voltage Regulator

Package Outline

SOT-89

Dimensions in mm

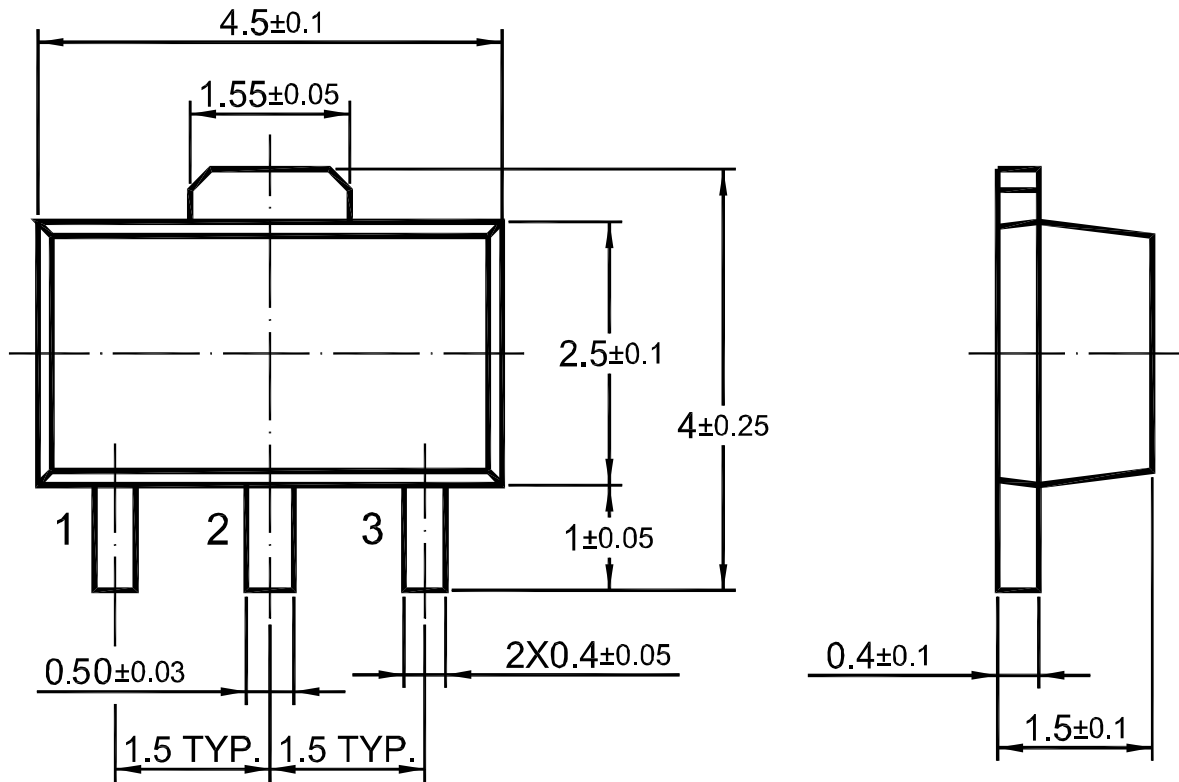

Ordering Information

Device	Package	Shipping
PJ78L06SQ	SOT-89	1,000/ Tape & Reel (7 inches)