

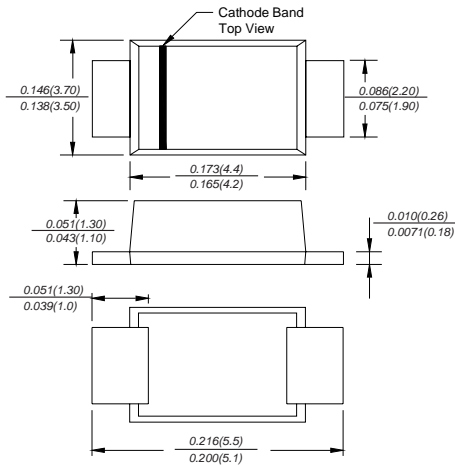

ST34BF THRU ST310BF

SURFACE MOUNT TRENCH SCHOTTKY RECTIFIER
 Reverse Voltage - 40 to 100 Volts Forward Current - 3.0 Amperes

SMBF



FEATURES

- ◆ The plastic package carries Underwriters Laboratory Flammability Classification 94V-0
- ◆ Metal silicon junction, majority carrier conduction
- ◆ High efficiency operation
- ◆ Ultra low forward voltage drop, low power losses
- ◆ High forward surge current capability
- ◆ High temperature soldering guaranteed:
 260°C/10 seconds, 0.375" (9.5mm) lead length,
 5 lbs. (2.3kg) tension

MECHANICAL DATA

Case: JEDEC SMBF molded plastic body
Terminals: leads solderable per MIL-STD-750, Method 2026
Mounting Position: Any
Weight: 57mg/0.002oz

MAXIMUM RATINGS AND ELECTRICAL CHARACTERISTICS

Ratings at 25°C ambient temperature unless otherwise specified.
 Single phase half-wave 60Hz, resistive or inductive load, for capacitive load current derate by 20%.

| MDD Catalog Number | SYMBOLS | ST34BF | ST36BF | ST310BF | UNITS | |
|--|-----------------|--------------------------|-------------|---------|-------|----|
| Maximum repetitive peak reverse voltage | V_{RRM} | 40 | 60 | 100 | V | |
| Maximum RMS voltage | V_{RMS} | 28 | 42 | 70 | V | |
| Maximum DC blocking voltage | V_{DC} | 40 | 60 | 100 | V | |
| Maximum average forward rectified current 0.375" (9.5mm) lead length (see fig. 1) | $I_{(AV)}$ | 3.0 | | | A | |
| Peak forward surge current 8.3ms single half sine-wave superimposed on rated load (JEDEC Method) | I_{FSM} | 80.0 | 60.0 | | A | |
| Maximum instantaneous forward voltage at 3.0A | V_F | 0.41 | 0.50 | 0.60 | V | |
| Maximum DC reverse current at rated DC blocking voltage | I_R | $T_A=25^\circ C$ 0.10 | 0.03 | 0.02 | mA | |
| $T_A=100^\circ C$ | | 20.0 | | 10.0 | | |
| Typical junction capacitance (NOTE 1) | C_J | 500 | | | pF | |
| Typical thermal resistance (NOTE 2) | $R_{\theta JA}$ | 68 | | | °C/W | |
| Operating junction temperature range | T_J | -55 to +125 | -55 to +150 | | °C | |
| Storage temperature range | T_{STG} | -55 to +150 | | | | °C |

Note: 1. Measured at 1MHz and applied reverse voltage of 4.0V D.C.
 2. Thermal resistance from junction to ambient at 0.375" (9.5mm) lead length, P.C.B. mounted



RATINGS AND CHARACTERISTIC CURVES ST34BF THRU ST310BF

AVERAGE FORWARD RECTIFIED CURRENT, AMPERES

FIG. 1- FORWARD CURRENT DERATING CURVE

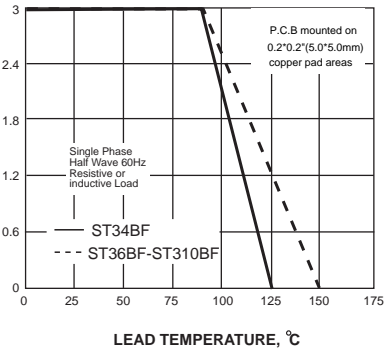

PEAK FORWARD SURGE CURRENT, AMPERES

FIG. 2-MAXIMUM NON-REPETITIVE PEAK FORWARD SURGE CURRENT

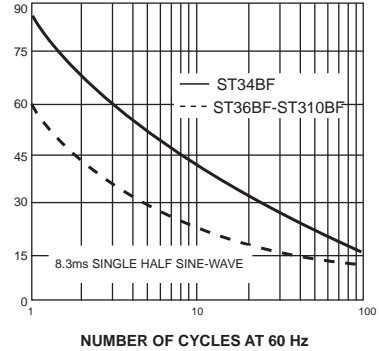

INSTANTANEOUS FORWARD CURRENT, AMPERES

FIG. 3-TYPICAL INSTANTANEOUS FORWARD CHARACTERISTICS

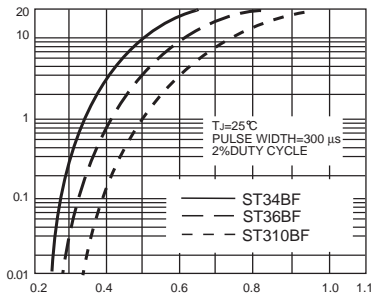

INSTANTANEOUS FORWARD VOLTAGE, VOLTS

INSTANTANEOUS REVERSE CURRENT, MILLIAMPERES

FIG. 4-TYPICAL REVERSE CHARACTERISTICS

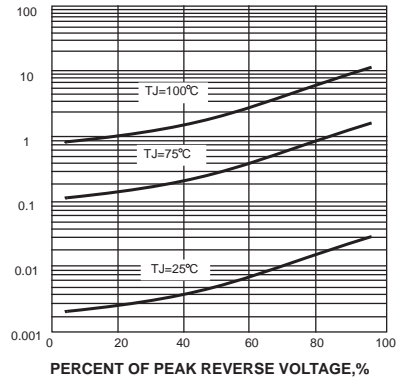

PERCENT OF PEAK REVERSE VOLTAGE, %

JUNCTION CAPACITANCE, pF

FIG. 5-TYPICAL JUNCTION CAPACITANCE

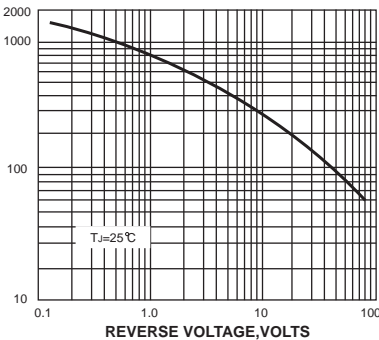

REVERSE VOLTAGE, VOLTS

TRANSIENT THERMAL IMPEDANCE, °C/W

FIG. 6-TYPICAL TRANSIENT THERMAL IMPEDANCE

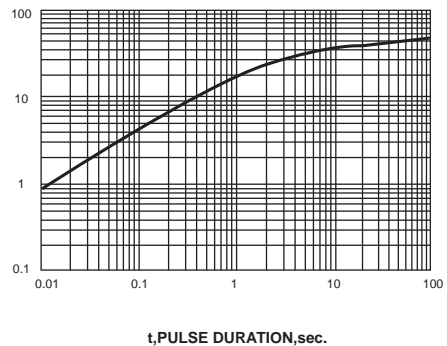

t, PULSE DURATION, sec.

The curve graph is for reference only, can't be the basis for judgment (曲线图仅供参考)!

