

SMA4728A THRU SMA4764A

1000mW Surface Mount Zener Diodes - 3.3V-100V

Features

- Batch process design, excellent power dissipation offers better reverse leakage current and thermal resistance.
- Standard zener voltage tolerance $\pm 5\%$.
- Low inductance.
- Low profile package.
- Built-in strain relief.
- Lead-free parts meet environmental standards of MIL-STD-19500 /228
- Suffix "-H" indicates Halogen free parts, ex. SMA4728A-H.

Mechanical data

- Epoxy : UL94-V0 rated flame retardant
- Case : Molded plastic, JEDEC DO-214AC / SMA
- Terminals :Plated terminals, solderable per MIL-STD-750, Method 2026
- Polarity : Indicated by cathode band
- Mounting Position : Any
- Weight : Approximated 0.07 gram

Package outline

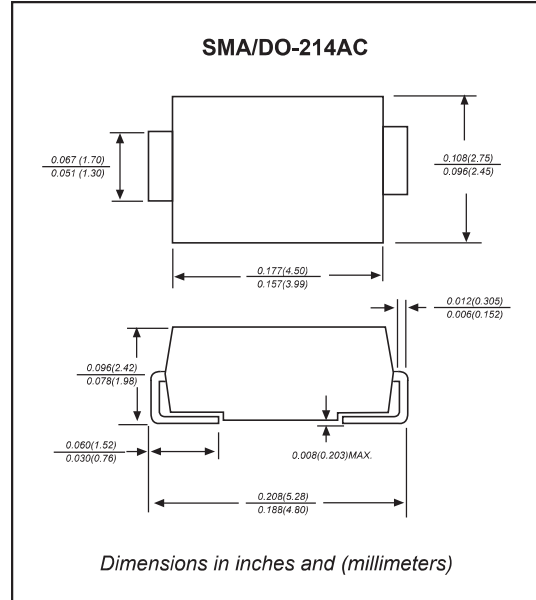

Maximum ratings (at $T_A=25^\circ\text{C}$ unless otherwise noted)

PARAMETER	CONDITIONS	Symbol	MIN.	TYP.	MAX.	UNIT
Forward voltage	$I_F = 200 \text{ mA}$	V_F			1.20	V
Power Dissipation	a: $T_L=75^\circ\text{C}$	P_D			1000	mW
Thermal resistance	Junction to case(Note 1)	$R_{\theta JC}$		30		$^\circ\text{C}/\text{W}$
	Junction to ambient(Note 1)	$R_{\theta JA}$		50		
Operating junction temperature range		T_J	-55		+150	$^\circ\text{C}$
Storage temperature range		T_{STG}	-65		+175	$^\circ\text{C}$

Note : 1, Mounted on 0.2"x0.2"(5x5mm)FR-4 PCB

SMA4728A THRU SMA4764A

Electrical characteristics (at $T_a=25^{\circ}\text{C}$ unless otherwise noted)

Part No.	Marking code	Zener voltage			Test current	Zener impedance			Leakage current		Maximum Surge current
		$V_Z @ I_{ZT}$ (Volts)				I_{ZT}	$Z_{ZT} @ I_{ZT}$	$Z_{ZK} @ I_{ZK}$	I_{ZK}	I_R	
		Min.	Nom.	Max.	mA	(Ω)Max	(Ω)Max	mA	(μA)Max	Volts	mApk
SMA4728A	Z3V3	3.14	3.3	3.47	76	10	400	1.00	100	1.0	1380
SMA4729A	Z3V6	3.42	3.6	3.78	69	10	400	1.00	100	1.0	1260
SMA4730A	Z3V9	3.71	3.9	4.10	64	9	400	1.00	50	1.0	1190
SMA4731A	Z4V3	4.09	4.3	4.52	58	9	400	1.00	10	1.0	1070
SMA4732A	Z4V7	4.47	4.7	4.94	53	8	500	1.00	10	1.0	970
SMA4733A	Z5V1	4.85	5.1	5.36	49	7	550	1.00	10	1.0	890
SMA4734A	Z5V6	5.32	5.6	5.88	45	5	600	1.00	10	2.0	810
SMA4735A	Z6V2	5.89	6.2	6.51	41	2	700	1.00	10	3.0	730
SMA4736A	Z6V8	6.46	6.8	7.14	37	3.5	700	1.00	10	4.0	660
SMA4737A	Z7V5	7.13	7.5	7.88	34	4.0	700	0.50	10	5.0	605
SMA4738A	Z8V2	7.79	8.2	8.61	31	4.5	700	0.50	10	6.0	550
SMA4739A	Z9V1	8.65	9.1	9.56	28	5	700	0.50	10	7.0	500
SMA4740A	Z10	9.50	10	10.50	25	7	700	0.25	10	7.6	454
SMA4741A	Z11	10.45	11	11.55	23	8	700	0.25	5	8.4	414
SMA4742A	Z12	11.40	12	12.60	21	9	700	0.25	5	9.1	380
SMA4743A	Z13	12.35	13	13.65	19	10	700	0.25	5	9.9	344
SMA4744A	Z15	14.25	15	15.75	17	14	700	0.25	5	11.4	304
SMA4745A	Z16	15.20	16	16.80	15.5	16	700	0.25	5	12.2	285
SMA4746A	Z18	17.10	18	18.90	14	20	750	0.25	5	13.7	250
SMA4747A	Z20	19.00	20	21.00	12.5	22	750	0.25	5	15.2	225
SMA4748A	Z22	20.90	22	23.10	11.5	23	750	0.25	5	16.7	205
SMA4749A	Z24	22.80	24	25.20	10.5	25	750	0.25	5	18.2	190
SMA4750A	Z27	25.65	27	28.35	9.5	35	750	0.25	5	20.6	170
SMA4751A	Z30	28.50	30	31.50	8.5	40	1000	0.25	5	22.8	150
SMA4752A	Z33	31.35	33	34.65	7.5	45	1000	0.25	5	25.1	135
SMA4753A	Z36	34.20	36	37.80	7.0	50	1000	0.25	5	27.4	125
SMA4754A	Z39	37.05	39	40.95	6.5	60	1000	0.25	5	29.7	115
SMA4755A	Z43	40.85	43	45.15	6.0	70	1500	0.25	5	32.7	110
SMA4756A	Z47	44.65	47	49.35	5.5	80	1500	0.25	5	35.8	95
SMA4757A	Z51	48.45	51	53.55	5.0	95	1500	0.25	5	38.8	90
SMA4758A	Z56	53.20	56	58.80	4.5	110	2000	0.25	5	42.6	80
SMA4759A	Z62	58.90	62	65.10	4.0	125	2000	0.25	5	47.1	70
SMA4760A	Z68	64.60	68	71.40	3.7	150	2000	0.25	5	51.7	65
SMA4761A	Z75	71.25	75	78.75	3.3	175	2000	0.25	5	56.0	60
SMA4762A	Z82	77.90	82	86.10	3.0	200	3000	0.25	5	62.2	55
SMA4763A	Z91	86.45	91	95.55	2.8	250	3000	0.25	5	69.2	50
SMA4764A	Z100	95.00	100	105.0	2.5	350	3000	0.25	5	76.0	45

Note : 5% tolerance of Zener voltage

Rating and characteristic curves (SMA4728A THRU SMA4764A)

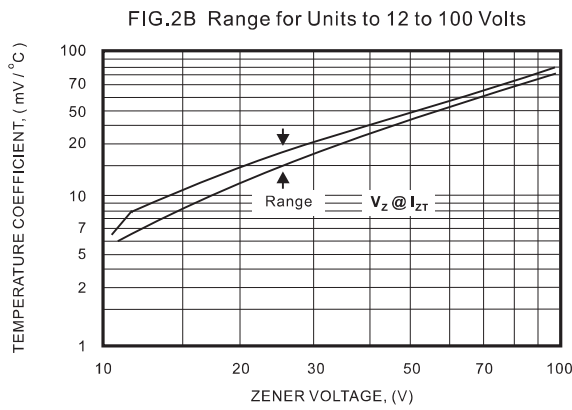
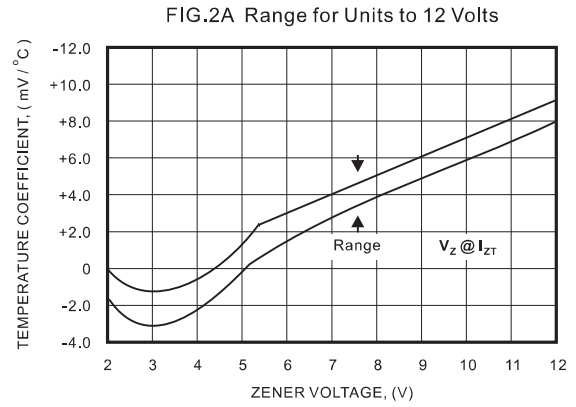
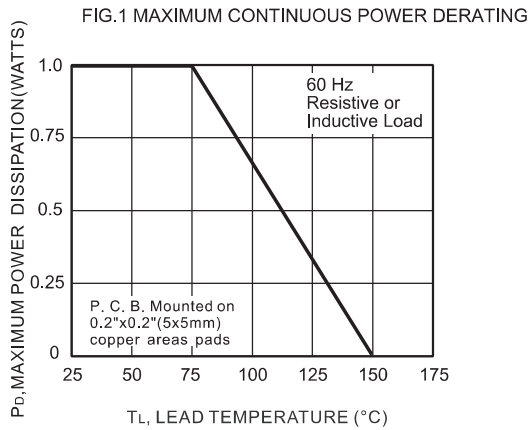
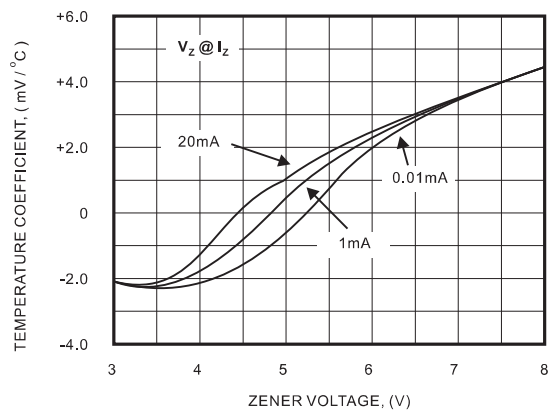
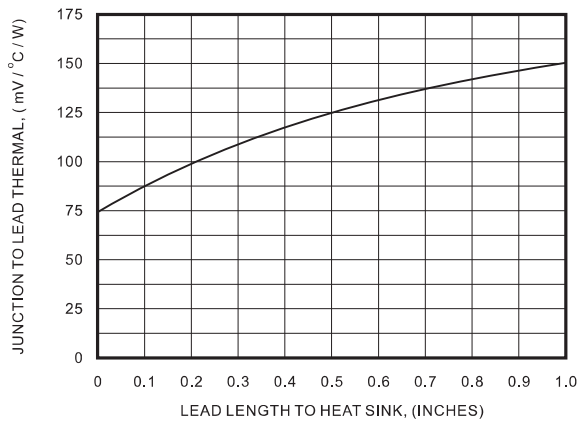

Fig. 3 Temperature Coefficients (-55°C to +150°C temperature change; 90% of the units are in the ranges indicated.)



Rating and characteristic curves (SMA4728A THRU SMA4764A)

Fig 4. Effect of Zener Voltage

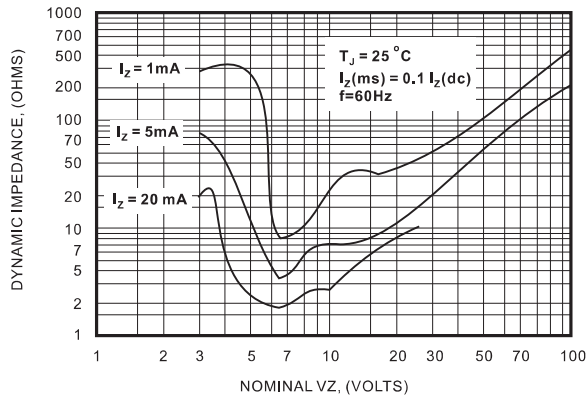

Fig 5. Effect of Zener Current

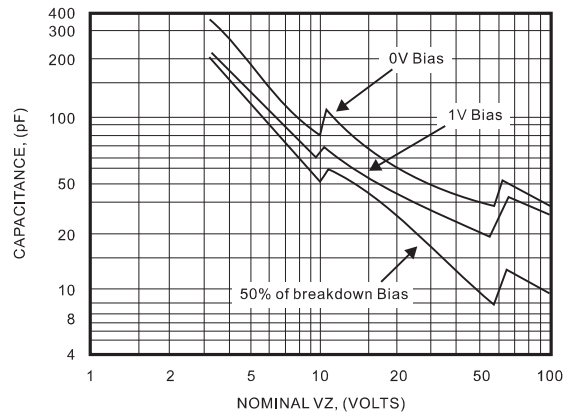
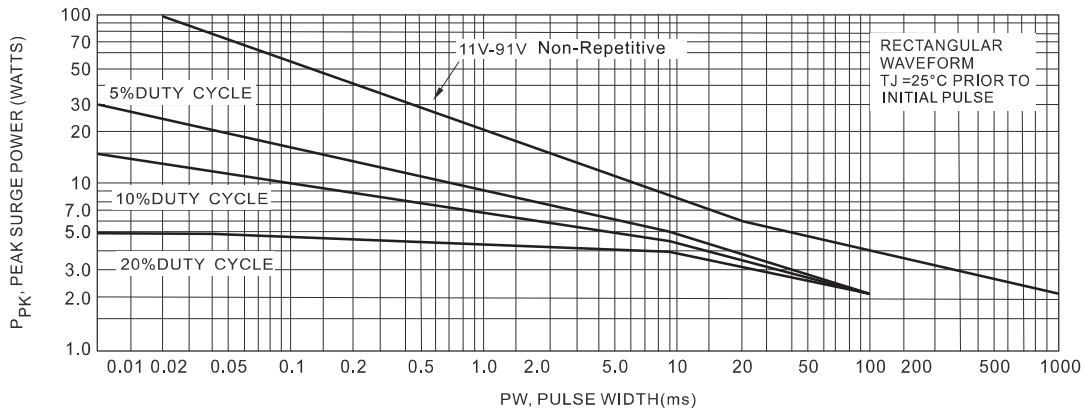



Fig 6. Maximum surge power



SMA4728A THRU SMA4764A

Pinning information

Pin	Simplified outline	Symbol
Pin1 cathode Pin2 anode		

Suggested solder pad layout

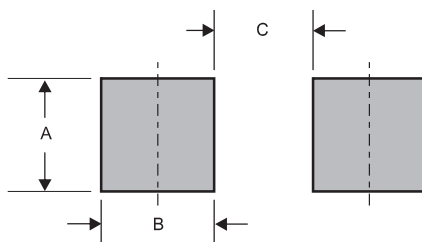

Dimensions in inches and (millimeters)

PACKAGE	A	B	C
SMA	0.110 (2.80)	0.063 (1.60)	0.087 (2.20)