

RFIC 2018.01 Update Rev1.7

DESCRIPTION

The SW423R is a broadband single-pole double-throw (SPDT) antenna switch fabricated with GaAs PHEMT process. Due to its excellent performance in insertion loss, isolation and linearity along with the ultra small form factor and low cost, the device is ideally suited for applications like IoT and embedded systems.

The SW423R is provided in a miniature 1mm x 1mm x 0.4mm, 6 pin DFN (Dual Flat No-lead) package.

KEY FEATURES

- Broadband frequency range: 0.1 to 6.0GHz
- Low insertion loss: 0.5dB typical @ 2.4-2.5GHz
- High isolation: 26dB typical @ 2.4-2.5GHz
27dB typical @ 4.9-5.9GHz
- Excellent linearity performance:
IP1dB = +30dBm (H/L=3/0V)
- Support 1.6V~ 5V control voltage
- Lead-Free and RoHS compliant
- Non-Reflective switch

Pin Detail

Pin Number	Name	Description
1	RF1	RF Port1
2	GND	GND
3	RF2	RF Port2
4	VC2	RF2 On/Off control voltage input of switch
5	RFC	RF Common Port
6	VC1	RF1 On/Off control voltage input of switch

Pin Assignment

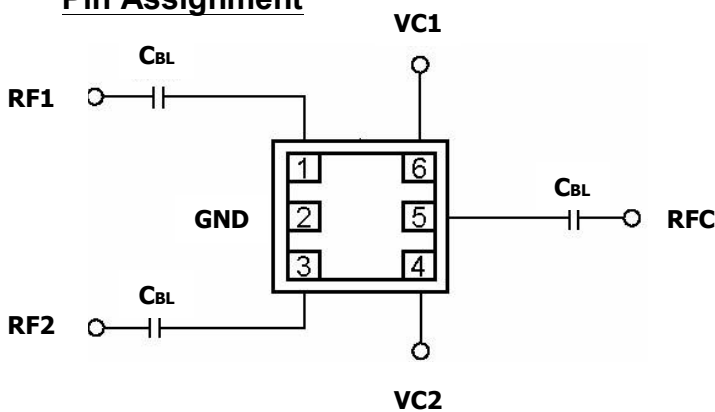

DC blocking capacitors are necessary for all RF ports (typical is 47 pF for > 1GHz application). All unused ports are terminated in 50 Ω.

Logic Control Table

VC1	VC2	RFC-RF1	RFC-RF2
High	Low	Off	On
Low	High	On	Off

High = +1.6V to +5V

Low = +0V to +0.2V

Important Note:

The information provided in this datasheet is deemed to be accurate and reliable only at present time. RFIC Technology Corp. reserves the right to make any changes to the specifications in this datasheet without prior notice.



Caution: ESD Sensitive
Appropriate precaution in handling, packaging And testing devices must be observed.

Absolute Maximum Ratings

Parameter	Rating	Unit
Control Voltage	+6	V
RF Input Power >500MHz	+33	dBm
Operating Ambient Temperature	-40 to +125	°C
Storage Temperature	-65 to +150	°C
Moisture Level	MSL1	
ESD Level	Class 1A HBM	

For more information, please contact us at:

Sales Dept.

Tel: +886-2-2698-1022

e-mail: sales@rfintc.com

© 2006 RFIC Technology Corporation All rights reserved.

RFIC Technology Corp. reserves the right to make changes to the specifications without notice.

Electrical Characteristics for +3V Control Voltages

Logic High = 1.6V~5V; Logic Low = 0~0.2V; TA = 25°C; unless otherwise noted.

Parameter	Specification			Units	Notes
	Min	Typ.	Max		
Insertion Loss		0.4	0.5	dB	DC – 1.0GHz
		0.6	0.7		1.0 – 3.0GHz
		0.8	1.1		3.0 – 5.0GHz
		0.5	0.6		2.4 – 2.5GHz
		1.0	1.2		4.9 – 5.9GHz
Isolation	25	27		dB	DC – 1.0GHz
	24	27			1.0 – 3.0GHz
	24	27			3.0 – 5.0GHz
	24	26			2.4 – 2.5GHz
	25	27			4.9 – 5.9GHz
VSWR		1:2:1	1:5:1		DC – 6GHz
IIP ₃		50		dBm	+15dBm per tone, Δf=5MHz V _{High} =3V, V _{Low} =0V
IP _{1dB}		32		dBm	V _{High} =5V, V _{Low} =0V V _{High} =3V, V _{Low} =0V
		30			
Switching Speed					
	T _{ON}	100		ns	50% control to 90% RF
T _{OFF}		100		ns	50% control to 10% RF
Control Current		5	10	uA	

Note: All measurements made in a 50 ohm system. C_{BL}=47pF for > 1GHz application

RFIC 2018.01 Update Rev1.7

Typical Characteristic Chart

(RFC to RF1, RF2 (0, 2.7 V), TOP = +25°C)

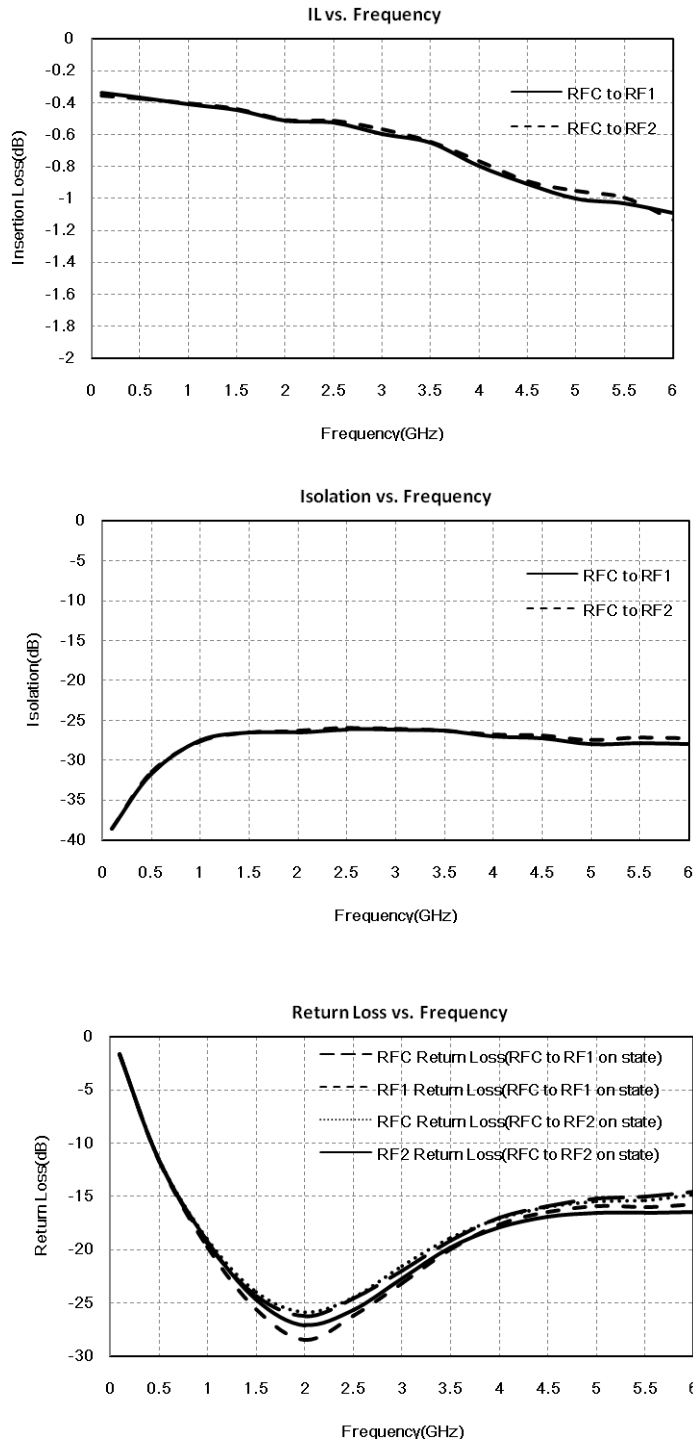

For more information, please contact us at:

Sales Dept.

Tel: +886-2-2698-1022

e-mail: sales@rfintc.com

© 2006 RFIC Technology Corporation All rights reserved.

RFIC Technology Corp. reserves the right to make changes to the specifications without notice.

Package Outline

Top View

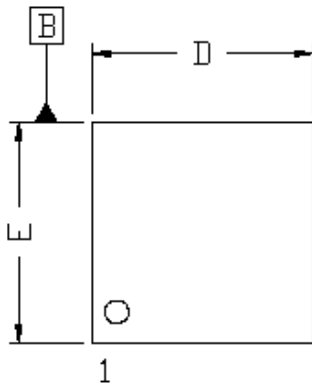

Bottom View

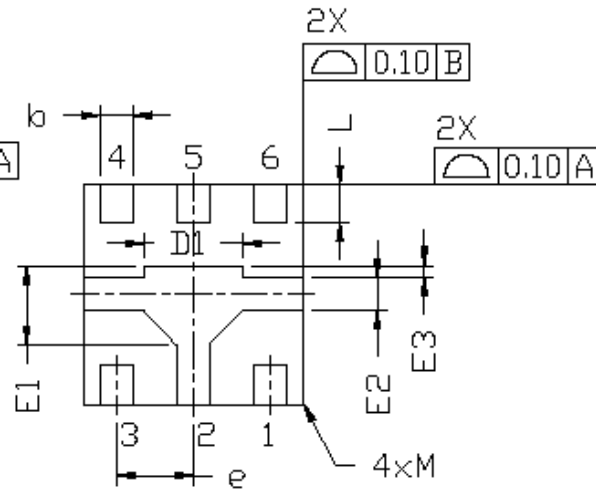

Side View

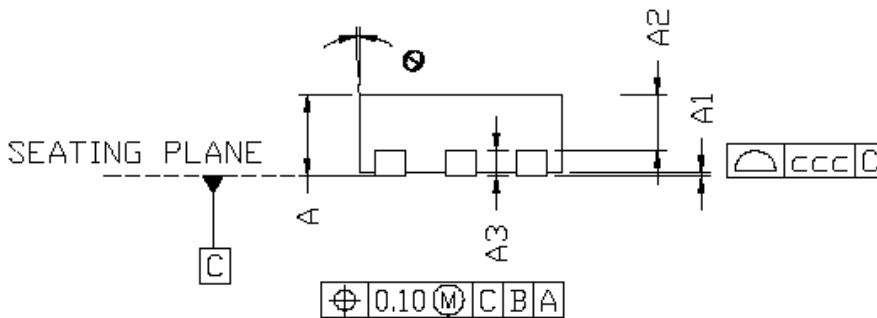

Symbol	Dimensions in Millimeters		
	MIN	NOM	MAX
A	0.35	---	0.40
A1	0.00	---	0.05
A2	0.223	---	0.273
A3	---	0.127REF	---
b	0.10	0.15	0.20
D	0.95	1.00	1.03
D1	---	0.45BSC	---
E	0.95	1.00	1.03
E1	---	0.36BSC	---
E2	0.10	0.15	0.20
E3	---	0.055BSC	---
e	---	0.35BSC	---
L	0.125	0.175	0.225
θ	-12	---	0
ccc	---	0.05	---
M	---	---	0.05
Burr	0.00	0.03	0.06

SW423R

Packing

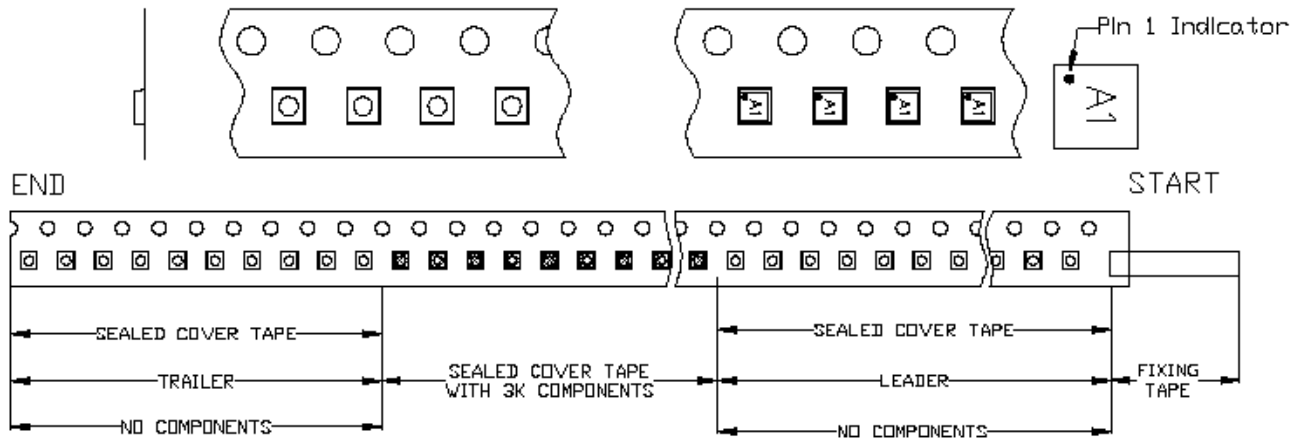

ITEM		SPECIFICATION (mm)(minimum)
LEADER	COVER TAPE WITH EMPTY CAVITIES	840(210格)
TRAILER	COVER TAPE WITH EMPTY CAVITIES	400(100格)
FIXING TAPE		100
PROTECTIVE BAND (t=1.0mm)		1200

PKG TYPE	Tape Width (mm)	Reel Size	Devices Per Reel
US0N6L-1x1x0.4mm US0N-6L(1.0x1.0)	8	7"	3000

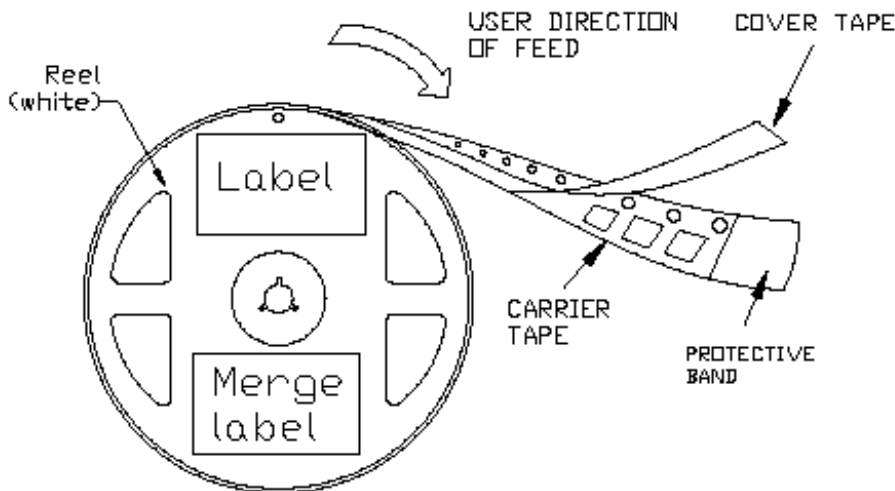



RFIC 2018.01 Update Rev1.7

CAUTION -Limitation of Applications-

The product is designed and manufactured for consumer application only and is not available for any application listed below which requires especially high reliability for the prevention of such defect as may directly cause damage to the third party's life, body or property.

- Aircraft equipment.
- Aerospace equipment.
- Undersea equipment.
- Medical equipment.
- Transportation equipment (vehicles, trains, ships, etc.).
- Traffic signal equipment.
- Disaster prevention / crime prevention equipment.
- Application of similar complexity and/ or reliability requirements to the applications listed in the above.