

FEATURES

- Extremely Fast Switching Speed
- Low forward voltage

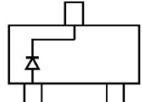

BAT54W Marking: KL5

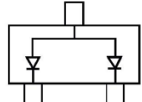

BAT54AW Marking: KL6

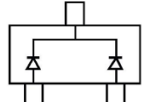

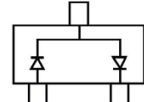

BAT54CW Marking: KL7

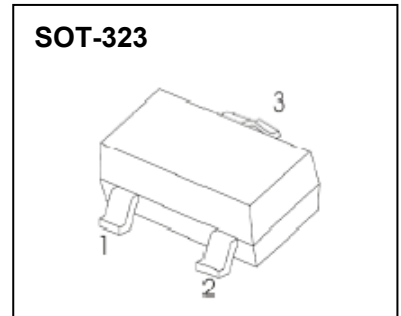

BAT54SW Marking: KL8

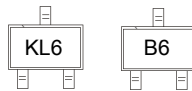

MARKING:

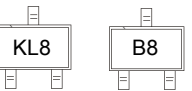
BAT54W	BAT54AW	BAT54CW	BAT54SW
			

MAXIMUM RATINGS ($T_a=25^\circ\text{C}$ unless otherwise noted)

Parameter	Symbol	Value	Unit
Peak Repetitive Reverse Voltage	V_{RRM}	30	V
Working Peak Reverse Voltage	V_{RWM}		
DC Blocking Voltage	V_R		
Forward Continuous Current	I_{FM}	200	mA
Non-repetitive Peak Forward Surge Current @ $t=8.3\text{ms}$	I_{FSM}	600	mA
Repetitive Peak Forward Current @ $t \leq 1\text{s}, \delta \leq 0.5$	I_{FRM}	300	mA
Power Dissipation	P_D	200	mW
Thermal Resistance from Junction to Ambient	$R_{\theta JA}$	500	$^\circ\text{C/W}$
Junction Temperature	T_j	125	$^\circ\text{C}$
Storage Temperature	T_{stg}	-55~+150	$^\circ\text{C}$

ELECTRICAL CHARACTERISTICS ($T_a=25^\circ\text{C}$ unless otherwise specified)

Parameter	Symbol	Test conditions	Min	Typ	Max	Unit
Reverse voltage	$V_{(BR)}$	$I_R=100\mu\text{A}$	30			V
Reverse current	I_R	$V_R=25\text{V}$			2	μA
Forward voltage	V_F	$I_{F1}=0.1\text{mA}$			0.24	V
		$I_{F2}=1\text{mA}$			0.32	V
		$I_{F3}=10\text{mA}$			0.40	V
		$I_{F4}=30\text{mA}$			0.50	V
		$I_{F5}=100\text{mA}$			1	V
Diode capacitance	C_D	$V_R=0\text{V}, f=1\text{MHz}$			10	pF
Reverse recovery time	t_{rr}	$I_F=I_R=10\text{mA}$ $I_{rr}=0.1 \times I_R, R_L=100\Omega$			5	ns

Typical Characteristics

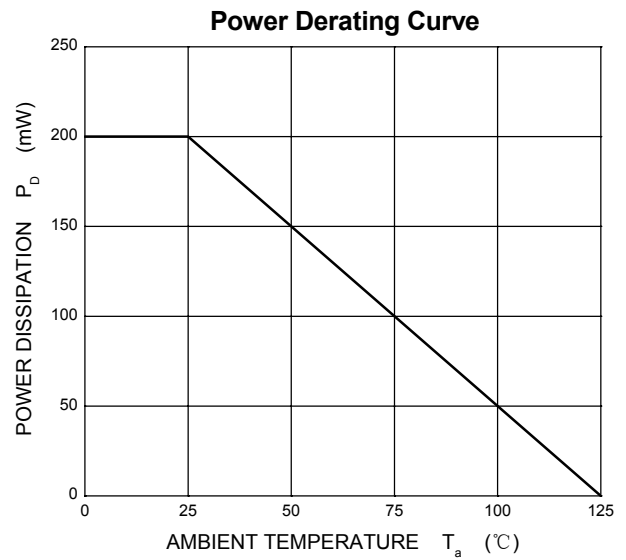
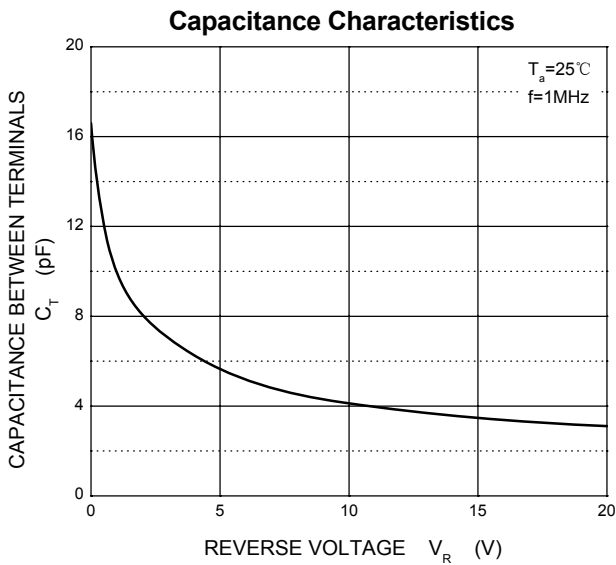
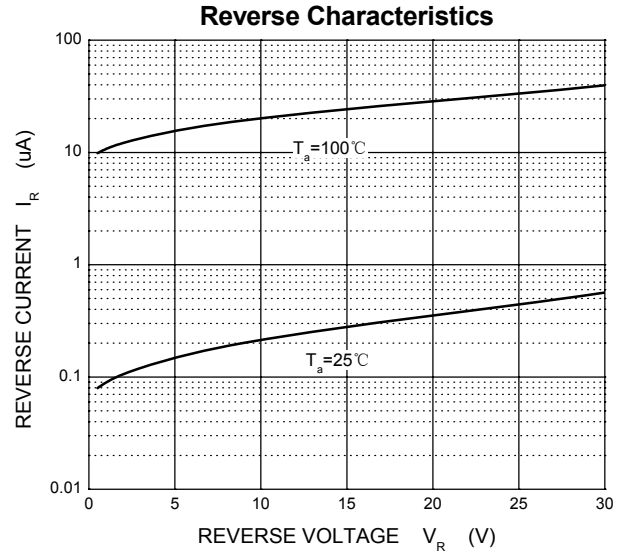
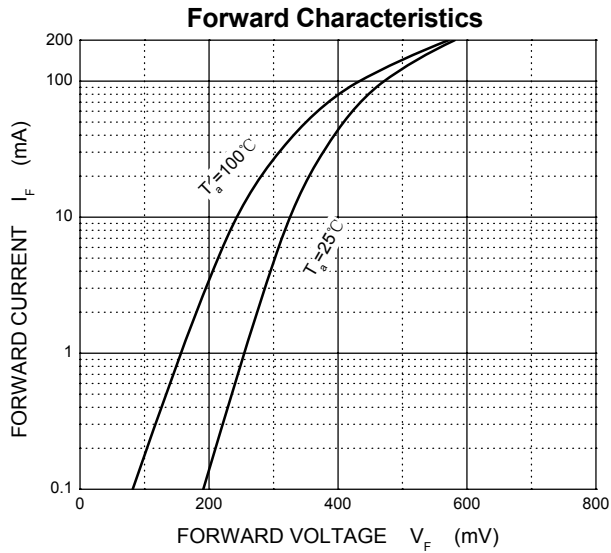

SOT-323 Package Outline Dimensions

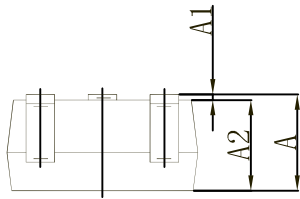
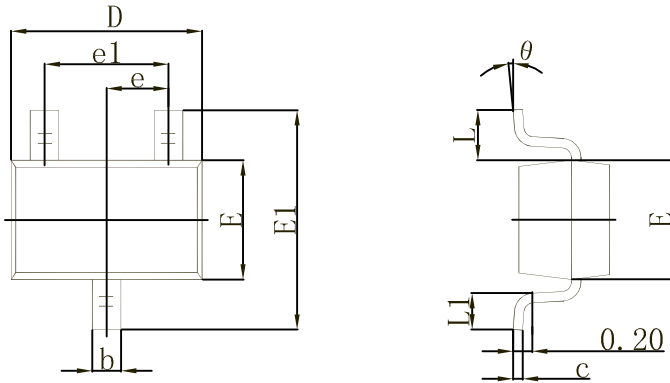

Symbol	Dimensions In Millimeters		Dimensions In Inches	
	Min	Max	Min	Max
A	0.900	1.100	0.035	0.043
A1	0.000	0.100	0.000	0.004
A2	0.900	1.000	0.035	0.039
b	0.200	0.400	0.008	0.016
c	0.080	0.150	0.003	0.006
D	2.000	2.200	0.079	0.087
E	1.150	1.350	0.045	0.053
E1	2.150	2.450	0.085	0.096
e	0.650 TYP		0.026 TYP	
e1	1.200	1.400	0.047	0.055
L	0.525 REF		0.021 REF	
L1	0.260	0.460	0.010	0.018
θ	0°	8°	0°	8°

SOT-323 Suggested Pad Layout

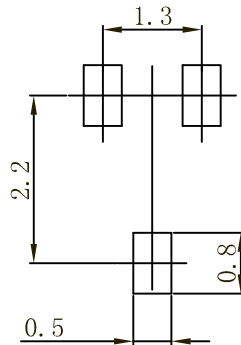

Note:

1. Controlling dimension: in millimeters.
2. General tolerance: $\pm 0.05\text{mm}$.
3. The pad layout is for reference purposes only.