

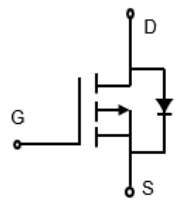

## Lonten P-channel -30V, -4.0A, 50mΩ Power MOSFET

<p><b>Description</b>                  These P-Channel enhancement mode power field effect transistors are using trench DMOS technology. This advanced technology has been especially tailored to minimize on-state resistance, provide superior switching performance, and with stand high energy pulse in the avalanche and commutation mode. These devices are well suited for high efficiency fast switching applications.</p> <p><b>Features</b></p> <ul style="list-style-type: none"> <li>◆ -30V,-4.0A,<math>R_{DS(ON).max}=50m\Omega@V_{GS}=-10V</math></li> <li>◆ Improved dv/dt capability</li> <li>◆ Fast switching</li> <li>◆ Green device available</li> </ul> <p><b>Applications</b></p> <ul style="list-style-type: none"> <li>◆ PWM applications</li> <li>◆ Load switch</li> <li>◆ Portable Equipment</li> </ul>	<p><b>Product Summary</b></p> <table style="width: 100%; border: none;"> <tr> <td style="padding: 2px;"><math>V_{DSS}</math></td> <td style="padding: 2px;">-30V</td> </tr> <tr> <td style="padding: 2px;"><math>R_{DS(on).max}@V_{GS}=-10V</math></td> <td style="padding: 2px;">50mΩ</td> </tr> <tr> <td style="padding: 2px;"><math>I_D</math></td> <td style="padding: 2px;">-4.0A</td> </tr> </table> <p><b>Pin Configuration</b></p> <div style="display: flex; justify-content: space-around; align-items: center;">   </div> <p style="text-align: center;"><b>SOT-23</b></p> <p style="text-align: center;">P-Channel MOSFET <span style="float: right;"></span></p>	$V_{DSS}$	-30V	$R_{DS(on).max}@V_{GS}=-10V$	50mΩ	$I_D$	-4.0A
$V_{DSS}$	-30V						
$R_{DS(on).max}@V_{GS}=-10V$	50mΩ						
$I_D$	-4.0A						

### Absolute Maximum Ratings $T_A = 25^\circ C$ unless otherwise noted

Parameter	Symbol	Value	Unit
Drain-Source Voltage	$V_{DSS}$	-30	V
Continuous drain current ( $T_A = 25^\circ C$ )	$I_D$	-4.0	A
Continuous drain current ( $T_A = 100^\circ C$ )		-2.5	A
Pulsed drain current <sup>1)</sup>	$I_{DM}$	-16.0	A
Gate-Source voltage	$V_{GSS}$	$\pm 12$	V
Power Dissipation ( $T_A = 25^\circ C$ )	$P_D$	1.2	W
Storage Temperature Range	$T_{STG}$	-55 to +150	$^\circ C$
Operating Junction Temperature Range	$T_J$	-55 to +150	$^\circ C$

### Thermal Characteristics

Parameter	Symbol	Value	Unit
Thermal Resistance, Junction-to-Case	$R_{\theta JA}$	104	$^\circ C/W$

**Package Marking and Ordering Information**

Device	Device Package	Marking
LPSC3481	SOT-23	3481

**Electrical Characteristics**
 $T_J = 25^\circ\text{C}$  unless otherwise noted

Parameter	Symbol	Test Condition	Min.	Typ.	Max.	Unit
<b>Static characteristics</b>						
Drain-source breakdown voltage	$BV_{DSS}$	$V_{GS}=0\text{ V}, I_D=-250\mu\text{A}$	-30	---	---	V
Gate threshold voltage	$V_{GS(th)}$	$V_{DS}=V_{GS}, I_D=-250\mu\text{A}$	-0.6	-0.95	-1.3	V
Drain-source leakage current	$I_{DSS}$	$V_{DS}=-30\text{ V}, V_{GS}=0\text{ V}, T_J = 25^\circ\text{C}$	---	---	-1	$\mu\text{A}$
		$V_{DS}=-24\text{ V}, V_{GS}=0\text{ V}, T_J = 125^\circ\text{C}$	---	---	-10	$\mu\text{A}$
Gate leakage current, Forward	$I_{GSSF}$	$V_{GS}=12\text{ V}, V_{DS}=0\text{ V}$	---	---	100	nA
Gate leakage current, Reverse	$I_{GSSR}$	$V_{GS}=-12\text{ V}, V_{DS}=0\text{ V}$	---	---	-100	nA
Drain-source on-state resistance	$R_{DS(on)}$	$V_{GS}=-10\text{ V}, I_D=-4\text{ A}$	---	41	50	m $\Omega$
		$V_{GS}=-4.5\text{ V}, I_D=-3.5\text{ A}$	---	47	60	m $\Omega$
		$V_{GS}=-2.5\text{ V}, I_D=-2.5\text{ A}$	---	60	85	m $\Omega$
Forward transconductance	$g_{fs}$	$V_{DS}=-5\text{ V}, I_D=-4.0\text{ A}$	---	15	---	S
<b>Dynamic characteristics</b>						
Input capacitance	$C_{iss}$	$V_{DS} = -15\text{ V}, V_{GS} = 0\text{ V},$ $F = 1\text{ MHz}$	---	1180	---	pF
Output capacitance	$C_{oss}$		---	80	---	
Reverse transfer capacitance	$C_{rss}$		---	68	---	
Turn-on delay time	$t_{d(on)}$	$V_{DD} = -15\text{ V}, V_{GS}=-10\text{ V}, I_D = -4\text{ A}$ $R_g=3\Omega$	---	1.8	---	ns
Rise time	$t_r$		---	30.2	---	
Turn-off delay time	$t_{d(off)}$		---	52.5	---	
Fall time	$t_f$		---	7.3	---	
Gate resistance	$R_g$	$V_{GS}=0\text{ V}, V_{DS}=0\text{ V}, f=1\text{ MHz}$	---	11.5	---	$\Omega$
<b>Gate charge characteristics</b>						
Gate to source charge	$Q_{gs}$	$V_{DS}=-15\text{ V}, I_D=-4.0\text{ A},$ $V_{GS}=-10\text{ V}$	---	2.1	---	nC
Gate to drain charge	$Q_{gd}$		---	2.3	---	
Gate charge total	$Q_g$		---	19.3	---	
<b>Drain-Source diode characteristics and Maximum Ratings</b>						
Continuous Source Current	$I_S$		---	---	-4.0	A
Pulsed Source Current <sup>2)</sup>	$I_{SM}$		---	---	-16.0	A
Diode Forward Voltage	$V_{SD}$	$V_{GS}=0\text{ V}, I_S=-2\text{ A}, T_J=25^\circ\text{C}$	---	---	-1.2	V

**Notes:**

1: Repetitive Rating: Pulse width limited by maximum junction temperature.

 2: Pulse Test: Pulse Width  $\leq 300\ \mu\text{s}$ , Duty Cycle  $\leq 2\%$ .

**Electrical Characteristics Diagrams**

Figure 1. Typ. Output Characteristics

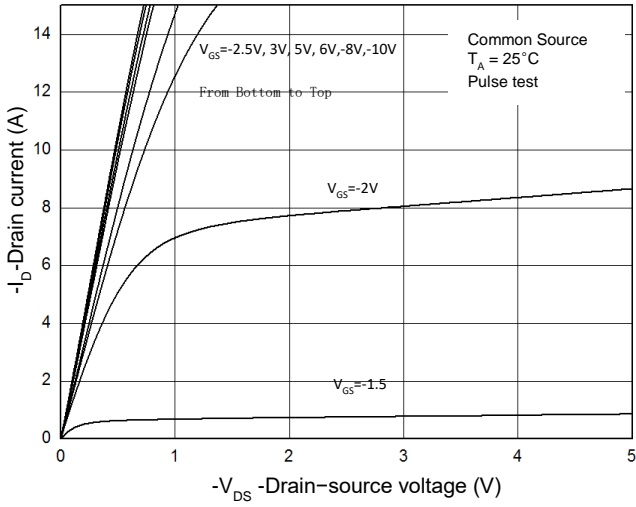

Figure 2. Transfer Characteristics

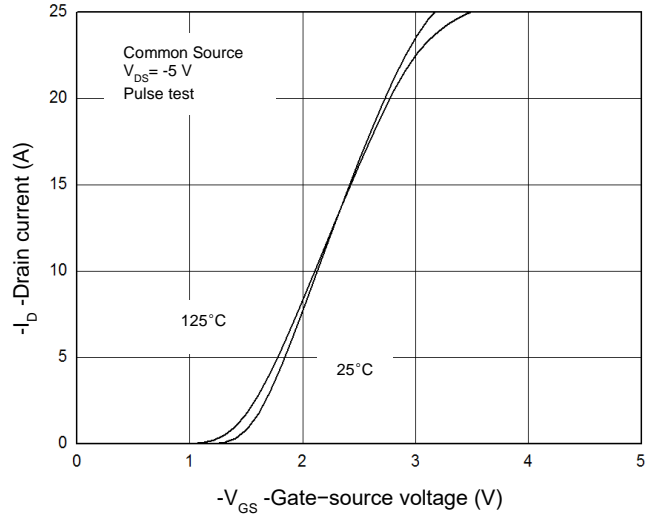

Figure 3. Capacitance Characteristics

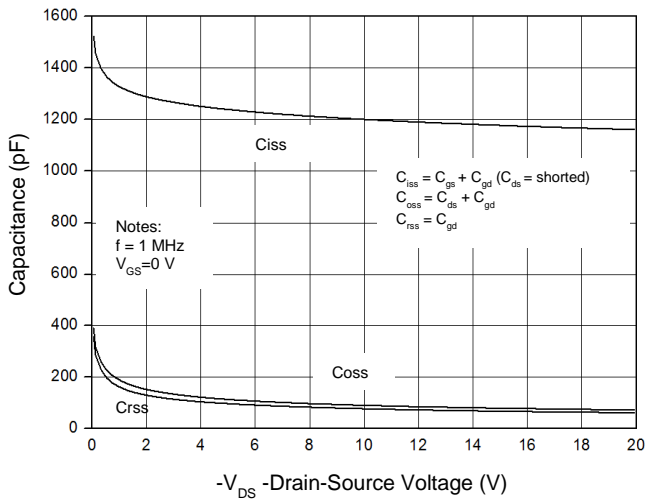

Figure 4. Gate Charge Waveform

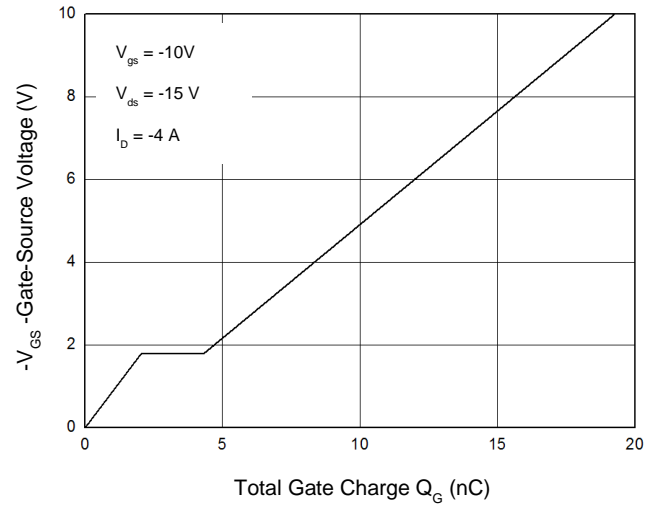

Figure 5. Body-Diode Characteristics

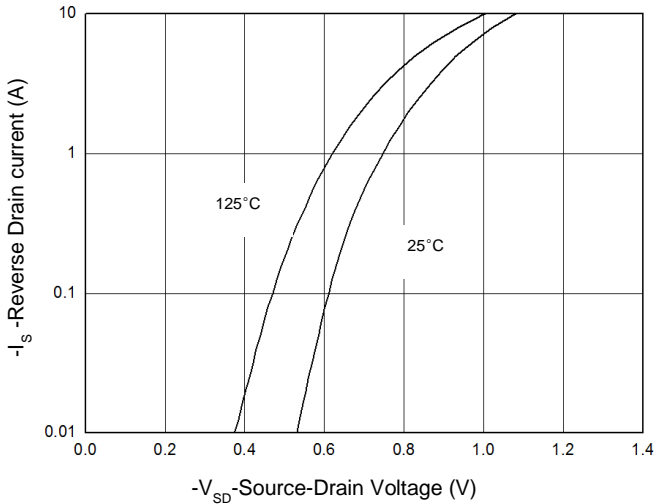

Figure 6. Rds(on)-Drain Current

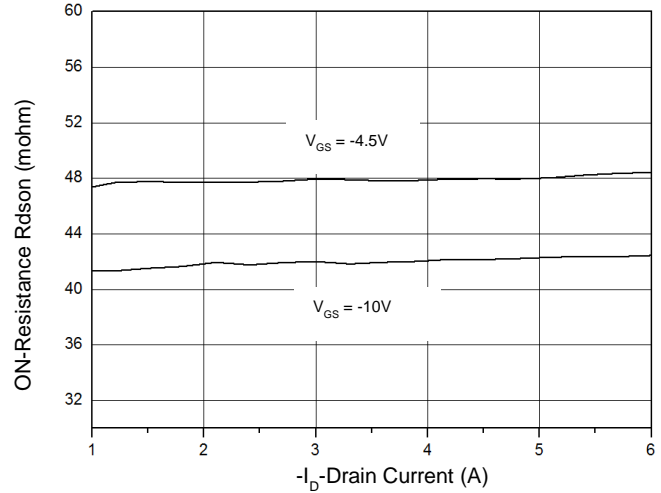

Figure 7. R<sub>ds(on)</sub>-Junction Temperature(°C)

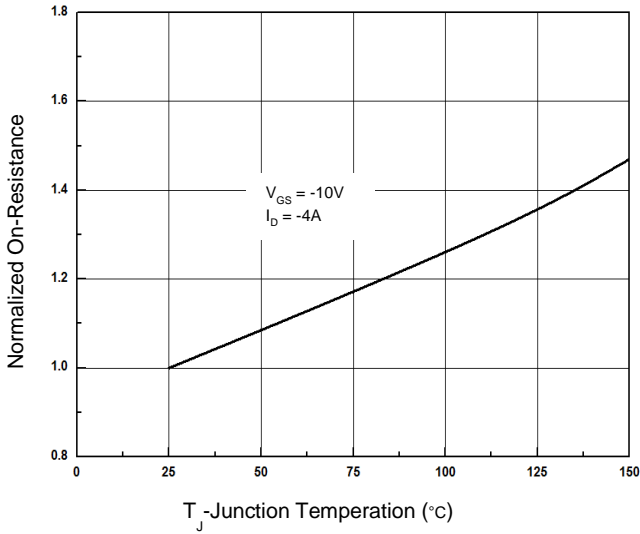

Figure 9. BV<sub>dss</sub> vs. Junction temperature(°C)

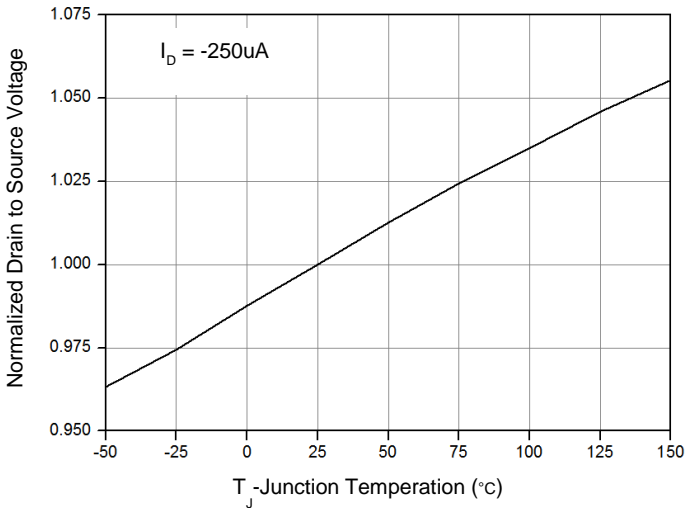

Figure 8. R<sub>ds(on)</sub> vs Gate Voltage

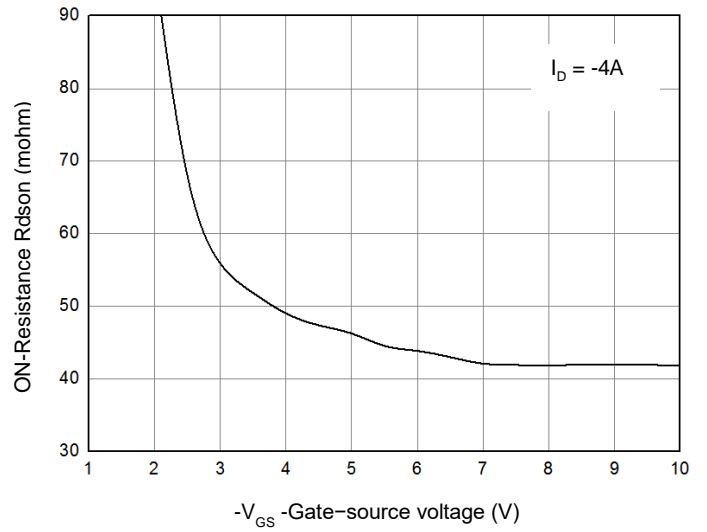

Figure 10. Maximum Safe Operating Area

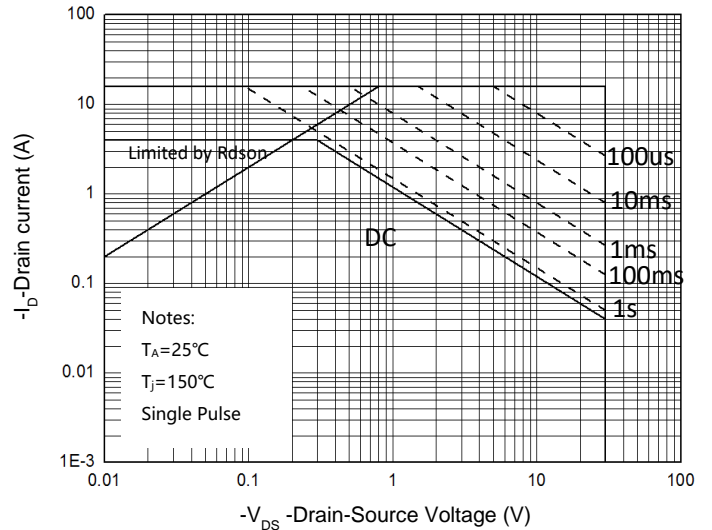
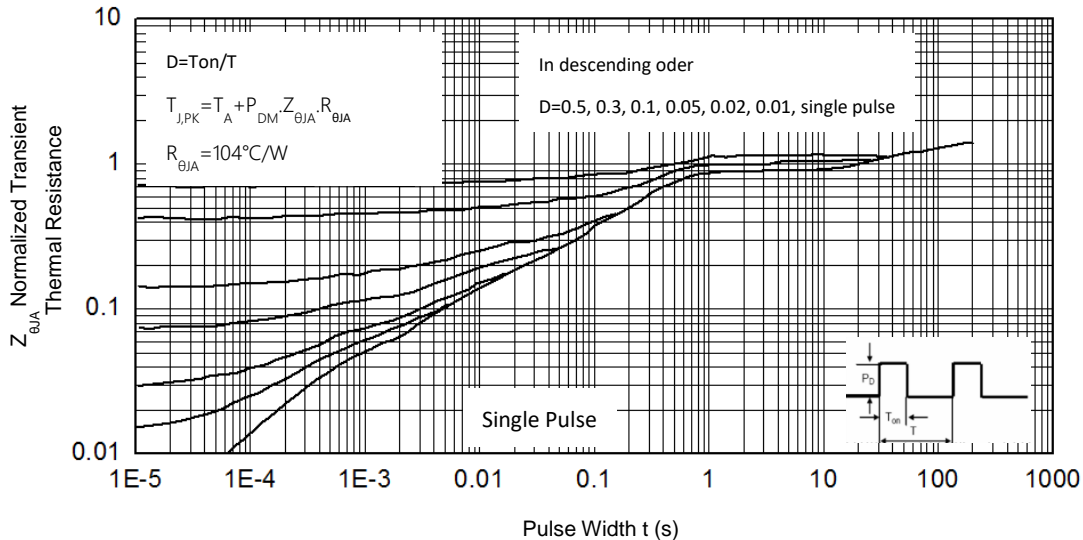

Figure 11. Normalized Maximum Transient Thermal Impedance (R<sub>thJA</sub>)



**Test Circuit & Waveform**

Figure 8. Gate Charge Test Circuit & Waveform

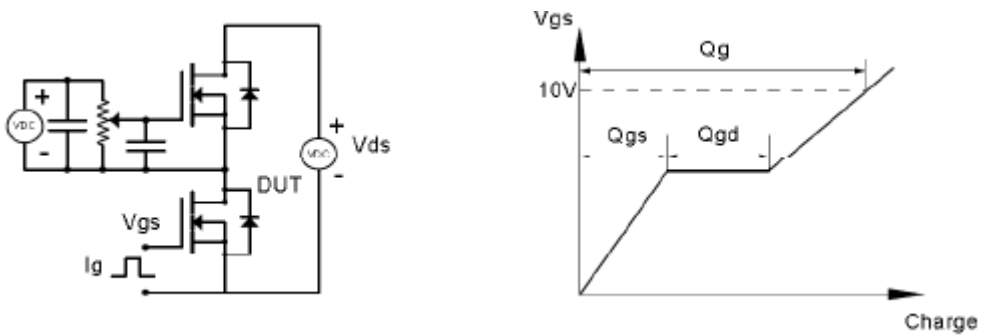

Figure 9. Resistive Switching Test Circuit & Waveforms

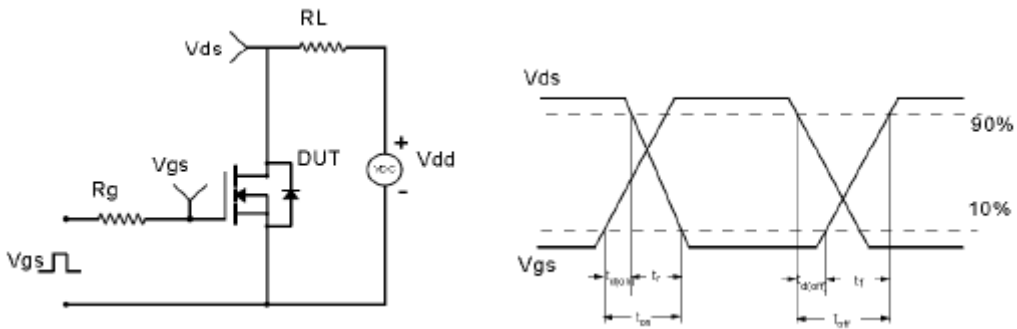

Figure 10. Unclamped Inductive Switching (UIS) Test Circuit & Waveform

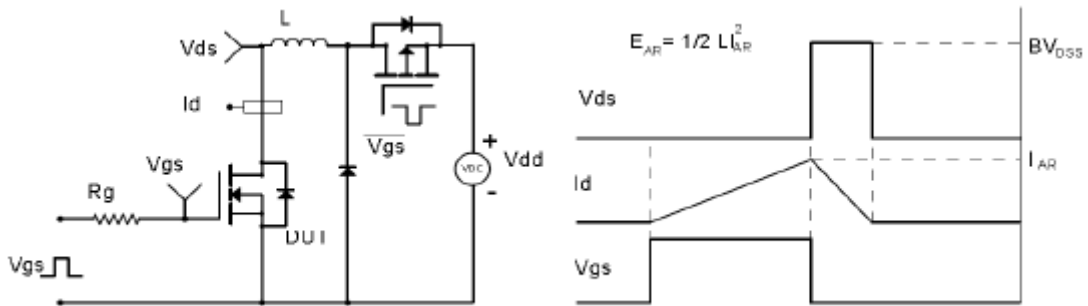
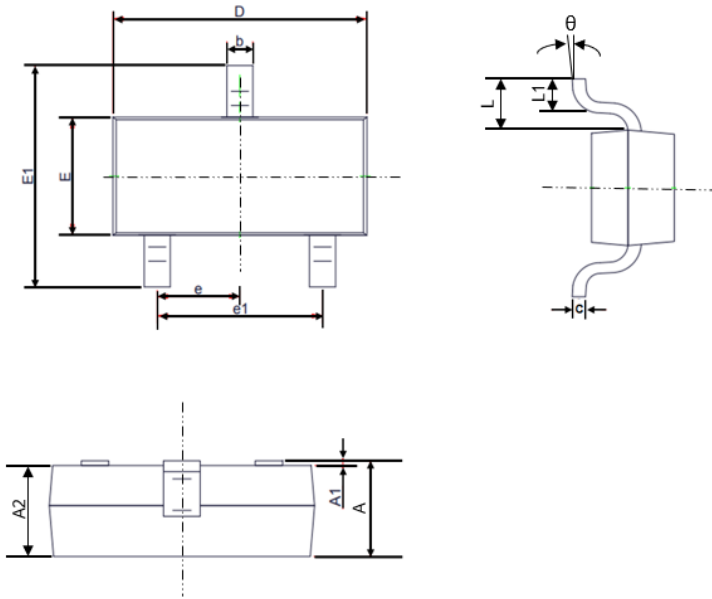

Figure 11. Diode Recovery Circuit & Waveform



## Mechanical Dimensions for SOT-23



SYMBOL	COMMON DIMENSIONS			
	MILLIMETERS		INCHS	
	MIN	MAX	MIN	MAX
A	0.90	1.20	0.035	0.047
A1	0.00	0.10	0.000	0.004
A2	0.90	1.10	0.035	0.043
b	0.39	0.45	0.015	0.018
c	0.08	0.15	0.003	0.006
D	2.80	3.00	0.110	0.118
E	1.20	1.40	0.047	0.055
E1	2.30	2.50	0.091	0.098
e	0.95 TYP.		0.037 TYP.	
e1	1.90 REF.		0.075 REF.	
L	0.55 REF.		0.022 REF.	
L1	0.20	-	0.008	-
$\theta$	0°	10°	0°	10°

## SOT-23 Part Marking Information

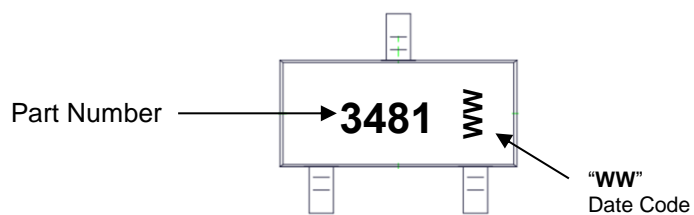

---

**Disclaimer**

The content specified herein is for the purpose of introducing LONTEN's products (hereinafter "Products"). The information given in this document shall in no event be regarded as a guarantee of conditions or characteristics. Examples of application circuits, circuit constants and any other information contained herein illustrate the standard usage and operations of the Products. The peripheral conditions must be taken into account when designing circuits for mass production.

LONTEN does not assume any liability for infringement of patents, copyrights, or other intellectual property rights of third parties by or arising from the use of the Products or technical information described in this document.

The Products are not designed or manufactured to be used with any equipment, device or system which requires an extremely high level of reliability the failure or malfunction of which may result in a direct threat to human life or create a risk of human injury (such as a medical instrument, transportation equipment, aerospace machinery, nuclear-reactor controller, fuel-controller or other safety device). LONTEN shall bear no responsibility in any way for use of any of the Products for the above special purposes.

Although LONTEN endeavors to improve the quality and reliability of its products, semiconductor products have specific characteristics such as the occurrence of failure at a certain rate and malfunctions under certain use conditions. Please be sure to implement safety measures to guard them against the possibility of physical injury, and injury or damage caused by fire in the event of the failure of a LONTEN product.

The content specified herein is subject to change for improvement without notice. When using a LONTEN product, be sure to obtain the latest specifications.