



PS2801-4



DESCRIPTION

The PS2801-4 is a four channel optically coupled isolator each channel consists of an infrared emitting diode and optically coupled to an NPN silicon photo transistor.

This device belongs to Isocom Compact Range of Optocouplers.

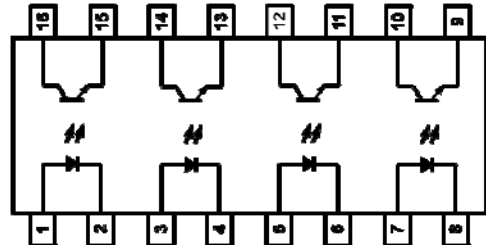

FEATURES

- Half Pitch 1.27mm
- High AC Isolation voltage 3000V_{RMS}
- Wide Operating Temperature Range -55°C to 110°C
- Pb Free and RoHS Compliant
- UL Approval E91231 Package Code "THP4"

APPLICATIONS

- Hybrid Substrates with High Density Mounting
- Industrial System Controllers
- Measuring Instruments
- System Appliances

ORDER INFORMATION

- Available in Tape and Reel with 2000pcs per reel

ABSOLUTE MAXIMUM RATINGS (T_A = 25°C)

Stresses exceeding the absolute maximum ratings can cause permanent damage to the device. Exposure to absolute maximum ratings for long periods of time can adversely affect reliability.

Input

Forward Current	50mA
Reverse Voltage	6V
Power dissipation	70mW

Output

Output Current	50mA
Collector to Emitter Voltage BV _{CEO}	80V
Emitter to Collector Voltage BV _{ECO}	7V
Power Dissipation	100mW

Total Package

Isolation Voltage	3000V _{RMS}
Total Power Dissipation	170mW
Operating Temperature	-55 to 110 °C
Storage Temperature	-55 to 150 °C
Lead Soldering Temperature (10s)	260°C

ISOCOM COMPONENTS 2004 LTD

Unit 25B, Park View Road West, Park View Industrial Estate
Hartlepool, Cleveland, TS25 1PE, United Kingdom
Tel : +44 (0)1429 863 609 Fax : +44 (0)1429 863 581
e-mail : sales@isocom.co.uk
<http://www.isocom.com>

ISOCOM COMPONENTS ASIA LTD

Hong Kong Office,
Block A, 8/F, Wah Hing Industrial mansion,
36 Tai Yau Street, San Po Kong, Kowloon, Hong Kong.
Tel : +852 2995 9217 Fax : +852 8161 6292
e-mail : sales@isocom.com.hk



PS2801-4

ELECTRICAL CHARACTERISTICS ($T_A = 25^\circ\text{C}$ unless otherwise specified)

INPUT

Parameter	Symbol	Test Condition	Min	Typ.	Max	Unit
Forward Voltage	V_F	$I_F = 20\text{mA}$		1.2	1.4	V
Reverse Current	I_R	$V_R = 4\text{V}$			10	μA
Terminal Capacitance	C_t	$V_F = 0\text{V}, f = 1\text{KHz}$		30	250	pF

OUTPUT

Parameter	Symbol	Test Condition	Min	Typ.	Max	Unit
Collector-Emitter Breakdown Voltage	BV_{CEO}	$I_F = 0, I_C = 0.1\text{mA}$	80			V
Emitter-Collector Breakdown Voltage	BV_{ECO}	$I_F = 0, I_E = 10\mu\text{A}$	7			V
Collector-Emitter Dark Current	I_{CEO}	$I_F = 0, V_{CE} = 48\text{V}$			100	nA

COUPLED

Parameter	Symbol	Test Condition	Min	Typ.	Max	Unit
Current Transfer Ratio	CTR	$I_F = 5\text{mA}, V_{CE} = 5\text{V}$	50		600	%
Collector-Emitter Saturation Voltage	$V_{CE(sat)}$	$I_F = 8\text{mA}, I_C = 2.4\text{mA}$			0.4	V
Floating Capacitance	C_f	$V_{CE} = 0\text{V}, f = 1\text{MHz}$		0.6	1	pF
Output Rise Time	t_r	$V_{CE} = 10\text{V},$ $I_C = 2\text{mA},$ $R_L = 100\Omega$		2	18	μs
Output Fall Time	t_f			3	18	
Turn-On Time	t_{ON}			3		
Turn-Off Time	t_{OFF}			3		
Turn-On Time	t_{ON}	$V_{CE} = 5\text{V},$ $I_C = 16\text{mA},$ $R_L = 1.9\text{k}\Omega$		2		
Turn-Off Time	t_{OFF}			40		
Storage Time	t_s			25		

ISOLATION

Parameter	Symbol	Test Condition	Min	Typ.	Max	Unit
Input to Output Isolation Voltage	V_{ISO}	$RH = 40\% - 60\%, t = 1 \text{ min}$ Note 1	3000			V_{RMS}
Input to Output Isolation Resistance	R_{ISO}	$RH = 40\% - 60\%, V_{IO} = 500\text{V}$ Note 1	5×10^{10}	1×10^{11}		Ω



PS2801-4

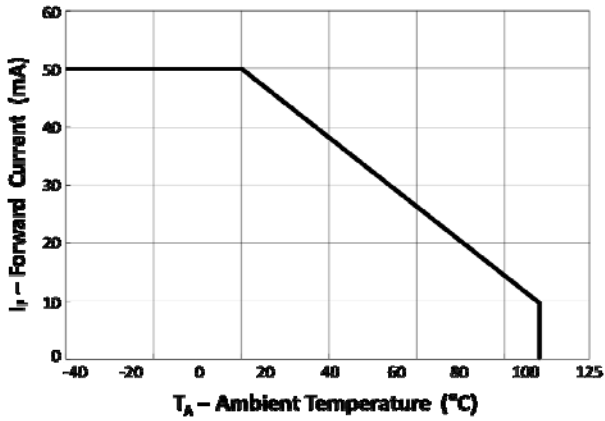

Fig 1 Forward Current vs T_A

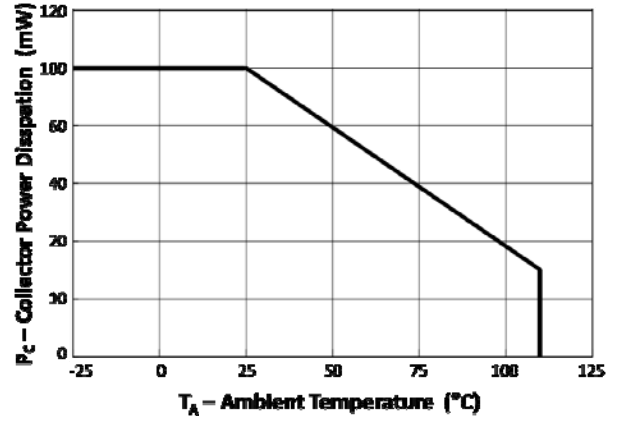

Fig 2 Collector Power Dissipation vs T_A

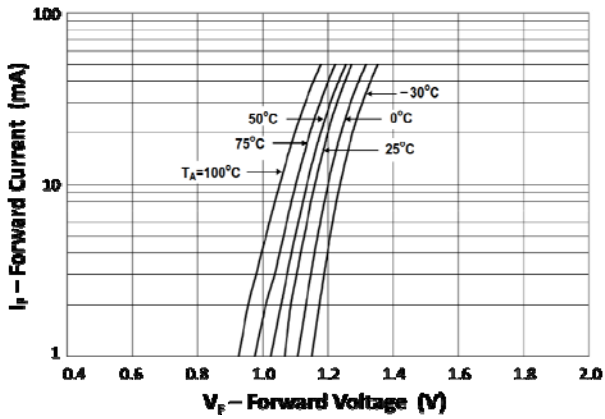

Fig 3 Forward Current vs Forward Voltage

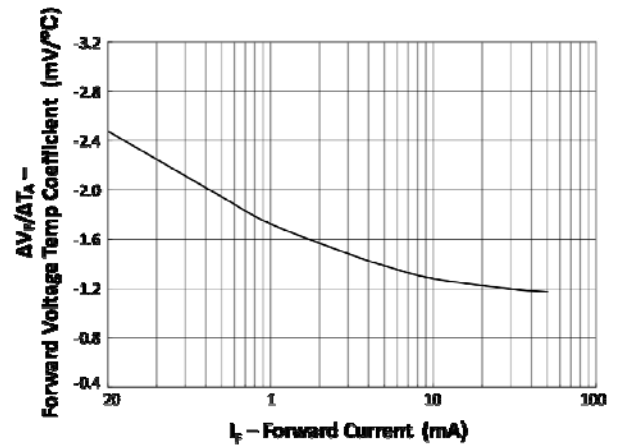

Fig 4 Forward Current Temperature Coefficient vs Forward Current

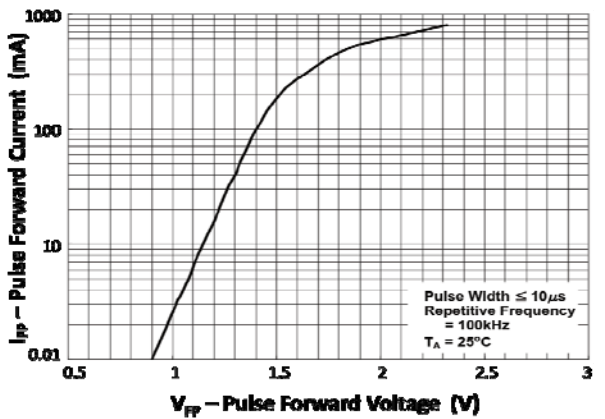

Fig 5 Pulse Forward Current vs Pulse Forward Voltage

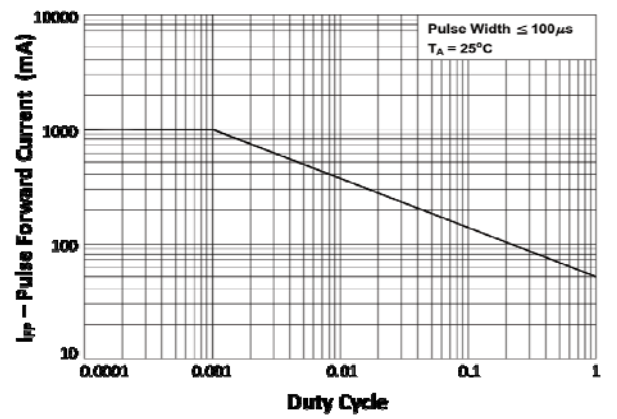

Fig 6 Pulse Forward Current vs Duty Cycle

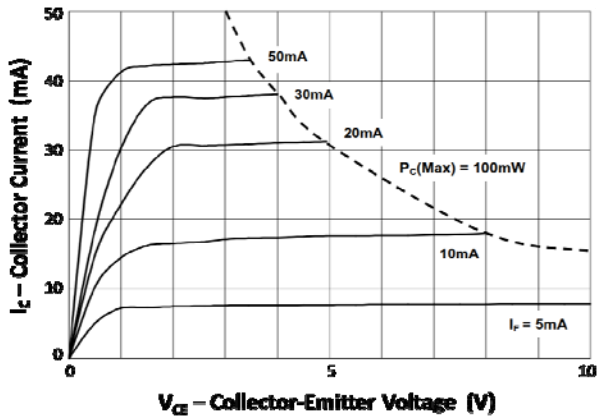

Fig 7 Collector Current vs Collector-Emitter Voltage

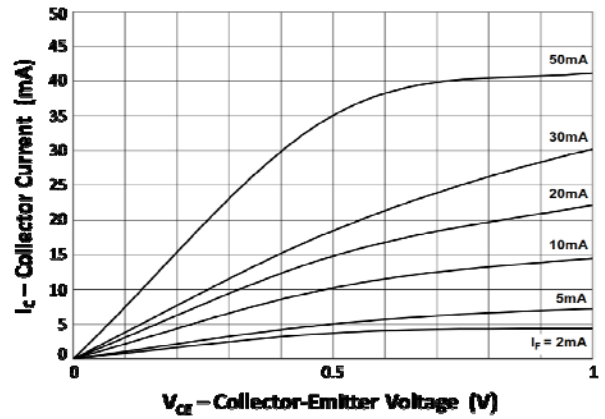

Fig 8 Collector Current vs Low Collector-Emitter Voltage

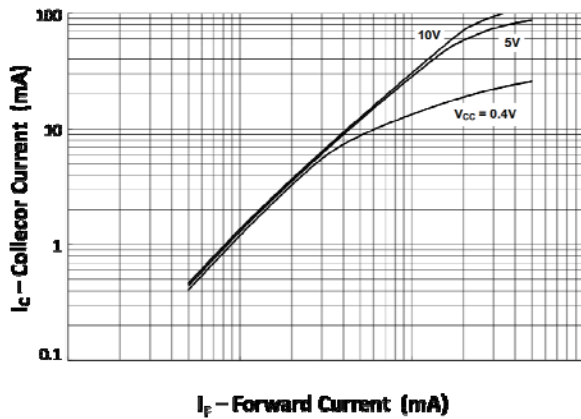

Fig 9 Collector Current vs Forward Current

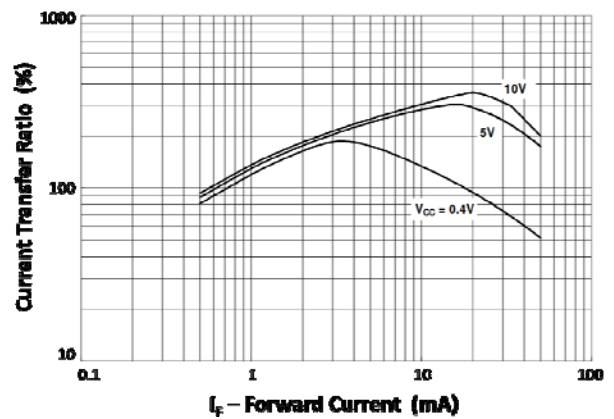

Fig 10 Current Transfer Ratio vs Forward Current

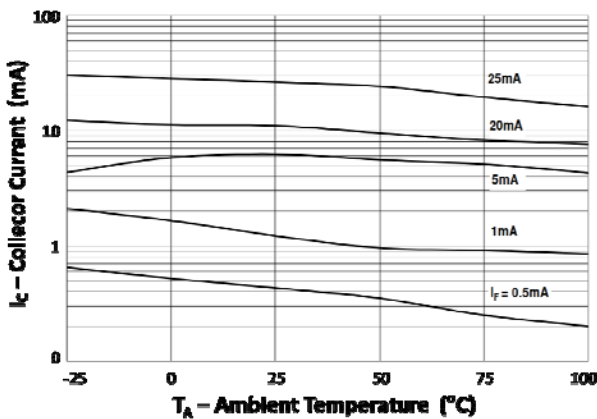

Fig 11 Collector Current vs T_A

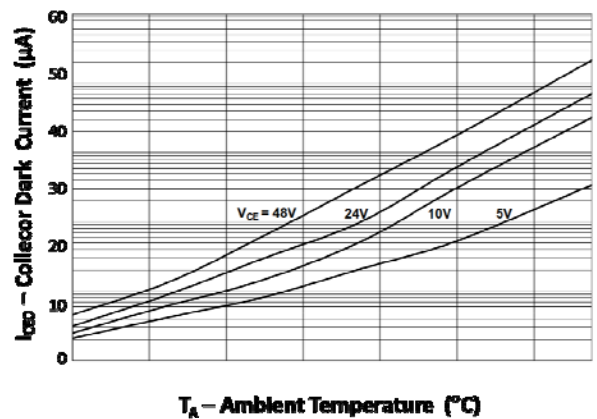

Fig 12 Collector Dark Current vs T_A

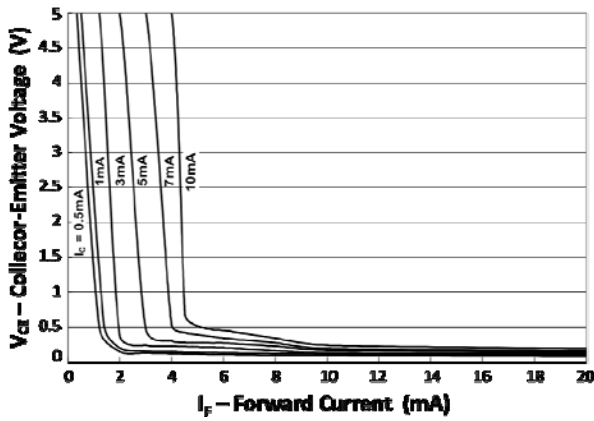

Fig 13 Collector-Emitter Voltage vs Forward Current

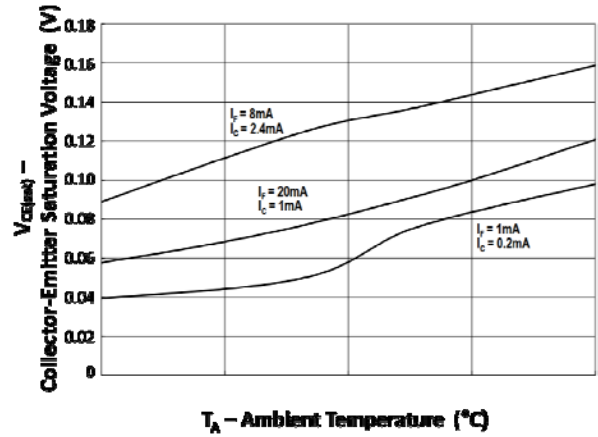

Fig 14 Collector-Emitter Saturation Voltage vs TA

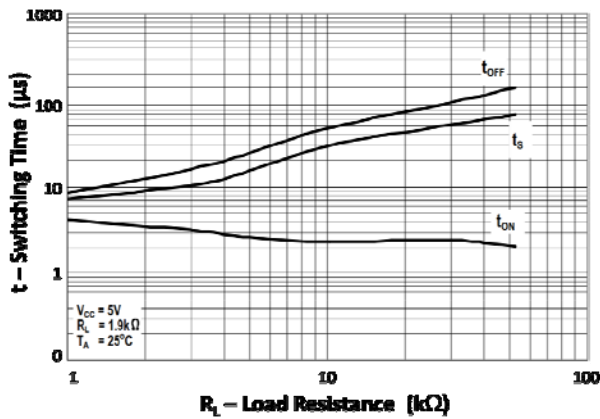

Fig 15 Switching Time vs Load Resistance

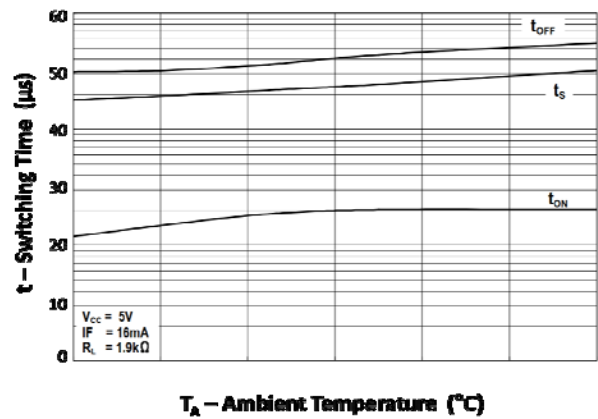

Fig 16 Switching Time vs TA

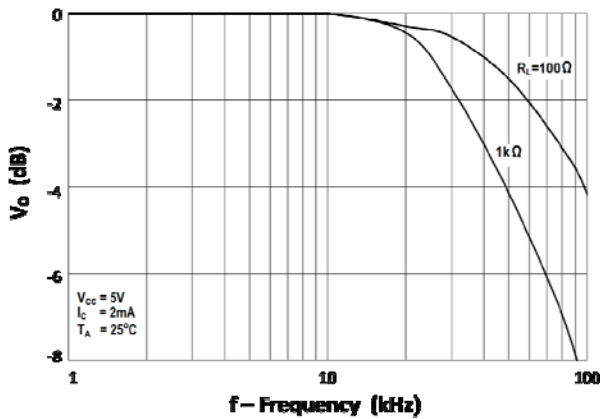
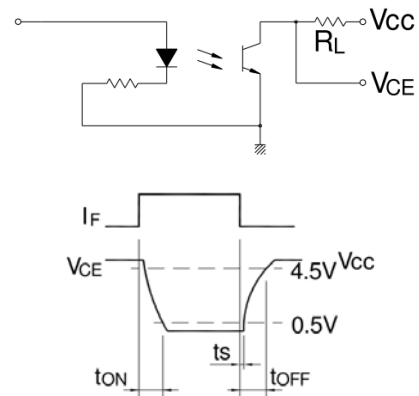

Fig 17 Frequency Response



Switching Time Test Circuit



PS2801-4

ORDER INFORMATION

UL Approval			
After PN	PN	Description	Packing quantity
None	PS2801-4	Surface Mount Tape & Reel	2000 pcs per reel

DEVICE MARKING

Example : PS2801-4

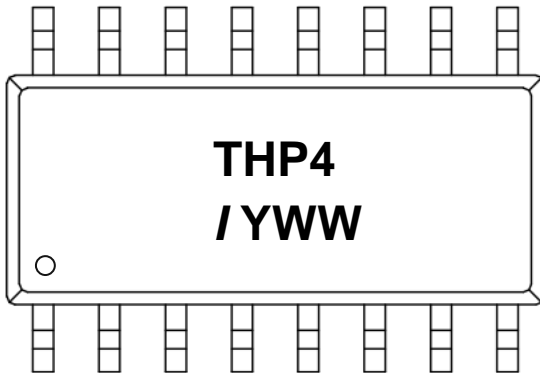

THP4 denotes Device Part Number
/ denotes Isocom
Y denotes 1 digit Year code
WW denotes 2 digit Week code



PS2801-4

PACKAGE DIMENSIONS (mm)

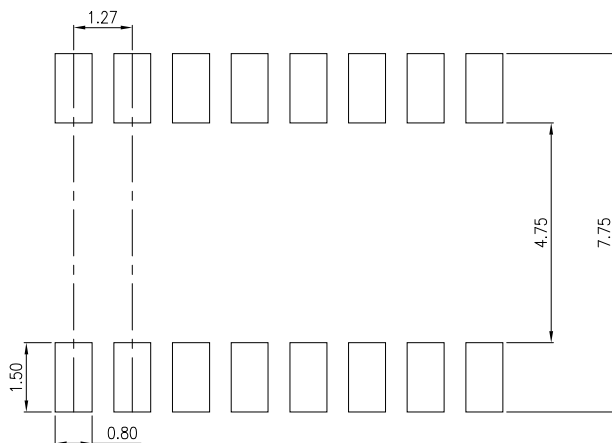
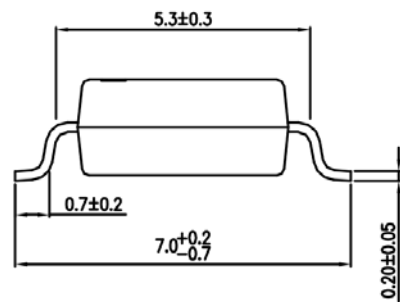
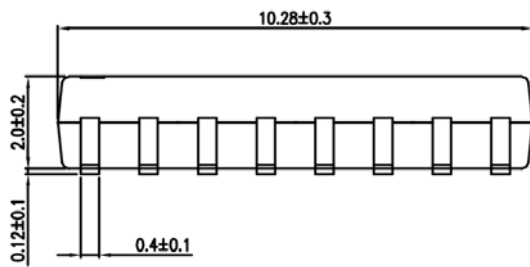
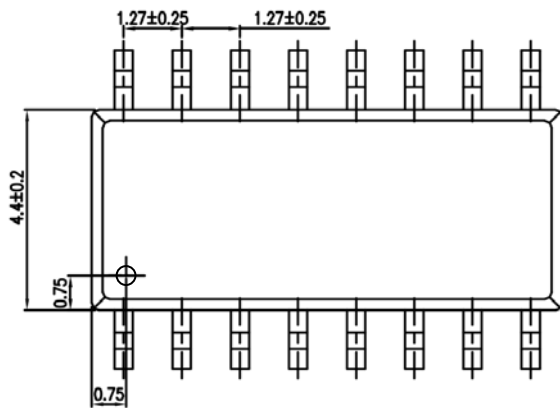

RECOMMENDED SOLDER PAD LAYOUT (mm)



PS2801-4

TAPE AND REEL PACKAGING

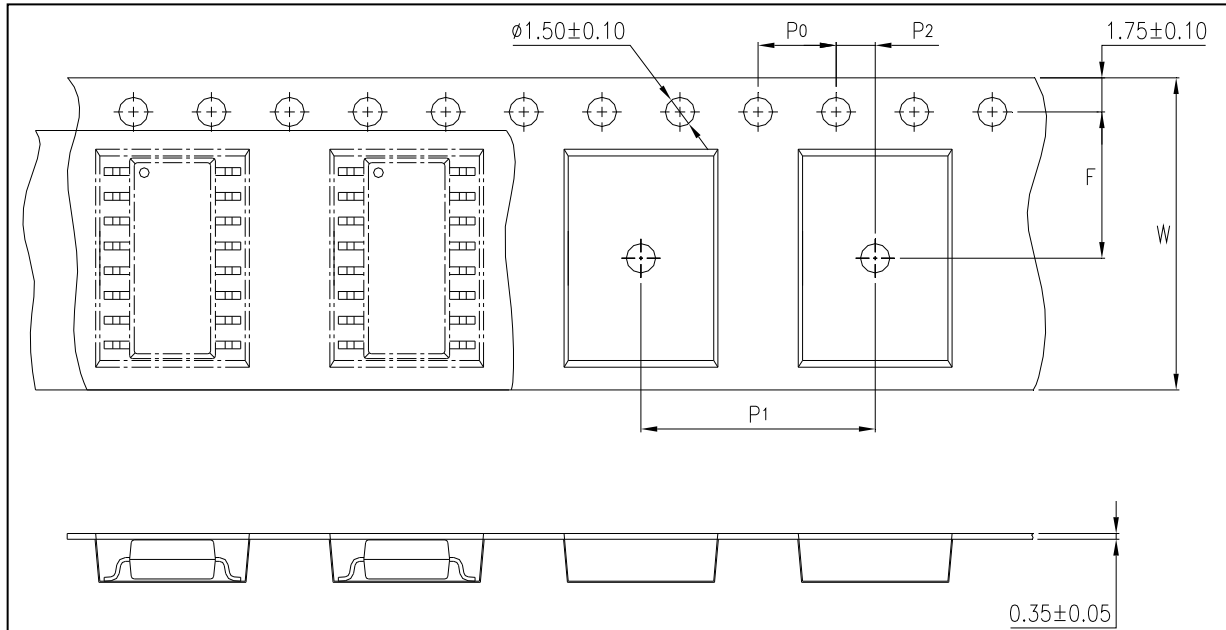

Description	Symbol	Dimension mm (inch)
Tape Width	W	16 ± 0.3 (0.63)
Pitch of Sprocket Holes	P ₀	4 ± 0.1 (0.15)
Distance of Compartment to Sprocket Holes	F	7.5 ± 0.1 (0.295)
	P ₂	2 ± 0.1 (0.079)
Distance of Compartment to Compartment	P ₁	12 ± 0.1 (0.47)



PS2801-4

IR REFLOW SOLDERING TEMPERATURE PROFILE

(One Time Reflow Soldering is Recommended)

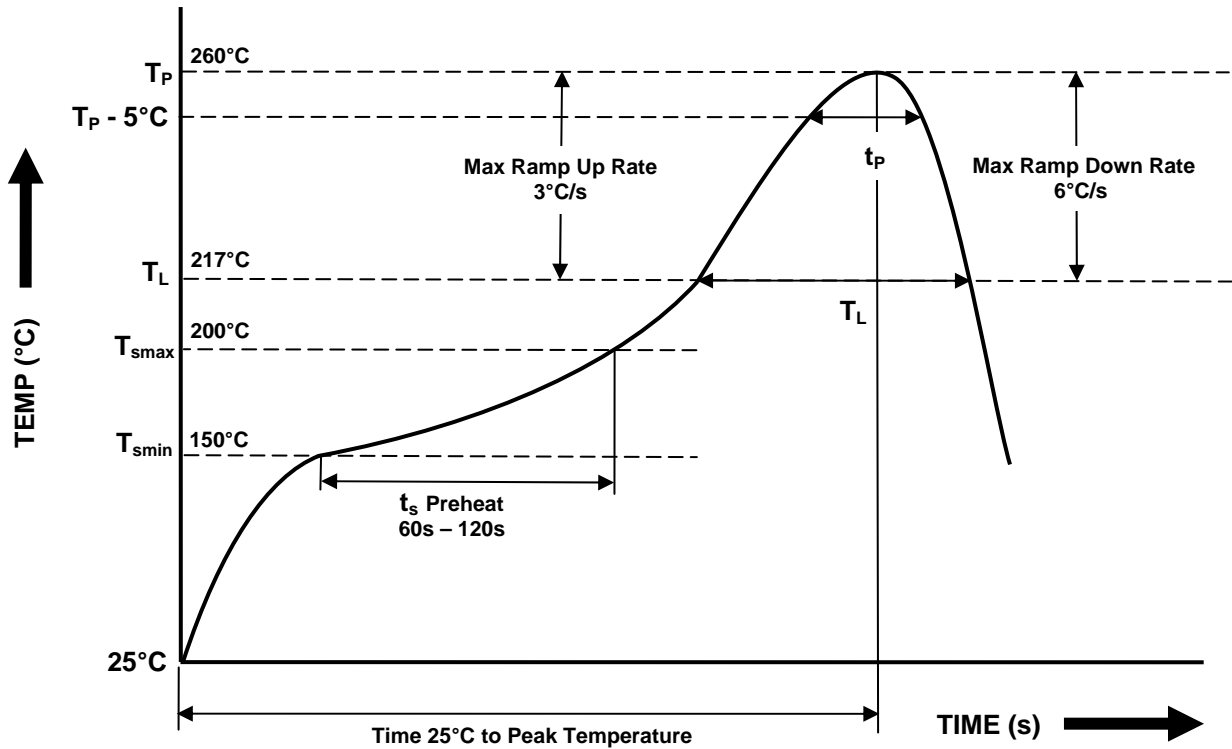

Profile Details	Conditions
Preheat - Min Temperature (T_{SMIN}) - Max Temperature (T_{SMAX}) - Time T_{SMIN} to T_{SMAX} (t_s)	150°C 200°C 60s - 120s
Soldering Zone - Peak Temperature (T_P) - Time at Peak Temperature - Liquidous Temperature (T_L) - Time within 5°C of Actual Peak Temperature ($T_P - 5^\circ C$) - Time maintained above T_L (t_L) - Ramp Up Rate (T_L to T_P) - Ramp Down Rate (T_P to T_L)	260°C 10s max 217°C 30s max 60s - 100s 3°C/s max 6°C/s max
Average Ramp Up Rate (T_{smax} to T_P)	3°C/s max
Time 25°C to Peak Temperature	8 minutes max

