

Specification for Approval

Date: 2014/12/12

Customer : 深圳台慶

TAI-TECH P/N: TMPC1206HP-Series(MG)-D

CUSTOMER P/N: _____

DESCRIPTION: _____

QUANTITY: _____ pcs

REMARK:

Customer Approval Feedback

西北臺慶科技股份有限公司
 TAI-TECH Advanced Electronics Co., Ltd
 Headquarter:
 NO.1 YOU 4TH ROAD, YOUTH INDUSTRIAL DISTRICT, YANG-MEI,
 TAO-YUAN HSIEN, TAIWAN, R.O.C.
 TEL: +886-3-4641148 FAX: +886-3-4643565
 http://www.tai-tech.com.tw
 E-mail: sales@tai-tech.com.tw

東莞臺慶精密電子有限公司
 DONGGUAN TAI-TECH ADVANCED ELECTRONICS CO., LTD
 JITIGANG MANAGEMENT DISTRICT, HUANGJIANG, DONGGUAN,
 GUANGDONG, CHINA
 TEL: +86-769-3365488 FAX: +86-769-3366896
 E-mail: sales@tai-tech.net

Office:
 金亨國際有限公司
 KAMHENG INTERNATIONAL LIMITED
 TEL: +86-852-25772033 FAX: +86-852-28817778

臺慶精密電子(昆山)有限公司
 TAI-TECH ADVANCED ELECTRONICS(KUNSHAN) CO., LTD
 SHINWHA ROAD, KUNJIA HI-TECH INDUSTRIAL PARK, KUN-SHAN,
 JIANG-SU, CHINA
 TEL: +86-512-57619396 FAX: +86-512-57619688
 E-mail: sales@tai-tech.cn

Office:
 北欣國際有限公司
 NORTH STAR INTERNATIONAL LIMITED
 TEL: +86-512-57619396 FAX: +86-512-57619688

慶邦電子元器件(泗洪)有限公司
 TAIPAQ ELECTRONICS (SIHONG) CO., LTD
 JIN SHA JIANG ROAD , CONOMIC DEVELOPMENT ZONE SIHONG ,
 JIANGSU , CHINA.
 TEL: +86-527-88601191 FAX: +86-527-88601190
 E-mail: sales@taipaq.cn

Sales Dep.

| APPROVED | CHECKED |
|------------------|---------------------|
| 管哲頌 Eric Kuan | 曾詩涵 Angela Tseng |

R&D Center

| APPROVED | CHECKED | DRAWN |
|------------------|------------------|------------------|
| 楊祥忠 Mike Yang | 詹偉特 Jack Chan | 何秦芝 Sharon Ho |

SMD Power Inductor

TMPC1206HP-Series(MG)-D

| ECN HISTORY LIST | | | | | |
|------------------|----------|-------------|----------|---------|-------|
| REV | DATE | DESCRIPTION | APPROVED | CHECKED | DRAWN |
| 1.0 | 14/12/12 | 新發行 | 楊祥忠 | 詹偉特 | 何秦芝 |
| | | | | | |
| | | | | | |
| | | | | | |
| | | | | | |
| | | | | | |
| | | | | | |
| | | | | | |
| | | | | | |
| | | | | | |
| | | | | | |
| | | | | | |
| | | | | | |
| | | | | | |
| | | | | | |
| | | | | | |
| | | | | | |
| | | | | | |
| | | | | | |
| | | | | | |
| | | | | | |
| | | | | | |
| | | | | | |
| | | | | | |
| | | | | | |
| 備 註 | | | | | |

SMD Power Inductor

TMPC1206HP-Series(MG)-D

1. Features

1. Carbonyl Powder.
2. Compact design.
3. High current · low DCR · high efficiency.
4. Very low acoustic noise and very low leakage flux noise.
5. High reliability.
6. 100% Lead(Pb)-Free and RoHS compliant.



2. Applications

Note PC power system · incl. IMVP-6
DC/DC converter .

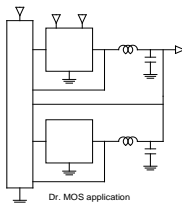

3. Dimensions

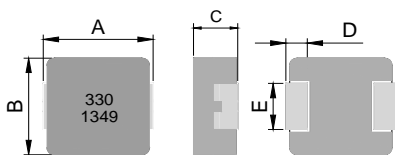

Recommend PC Board Pattern

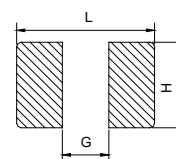

| Series | A(mm) | B(mm) | C(mm) | D(mm) | E(mm) |
|------------|----------|----------|---------|---------|---------|
| TMPC1206HP | 13.5±0.5 | 12.5±0.3 | 5.7±0.3 | 2.3±0.3 | 4.7±0.3 |

| L(mm) | G(mm) | H(mm) |
|-------|-------|-------|
| 14.2 | 8.0 | 5.0 |

4. Part Numbering



- A: Series
- B: Dimension
- C: Type
- D: Inductance
- E: Inductance Tolerance
- F: 印 D/C
- BxC
- HP:H:Carbonyl Powder,P:PAD broaden.
- 330=33uH
- M=±20%,Y=±30%
- 印字:黑色,330 及 D/C 1349 (13年,49週期,依實際生產周期而定)

5. Specification

| Part Number | Inductance L0 (uH)±20% @ 0 A | I rms (A) Typ. | I sat 1 (A) Typ. | I sat 2 (A) Typ. | DCR (mΩ) Typ. @25°C | DCR (mΩ) Max. @25°C |
|--------------------|---------------------------------|-------------------|------------------------|------------------------|---------------------------|---------------------------|
| TMPC1206HP-1R5MG-D | 1.50 | 26 | 43 | 50 | 2.7 | 3.2 |
| TMPC1206HP-2R2MG-D | 2.20 | 21 | 34 | 43 | 4.0 | 4.7 |
| TMPC1206HP-3R3MG-D | 3.30 | 17 | 28 | 35 | 5.8 | 7.1 |
| TMPC1206HP-4R7MG-D | 4.70 | 16 | 25 | 30 | 9.5 | 11.5 |
| TMPC1206HP-5R6MG-D | 5.60 | 15.5 | 22 | 28 | 10.8 | 12.6 |
| TMPC1206HP-6R8MG-D | 6.80 | 15 | 19 | 25 | 12 | 13.8 |
| TMPC1206HP-100MG-D | 10.0 | 11 | 15.5 | 21 | 18 | 20.7 |
| TMPC1206HP-120MG-D | 12.0 | 9.5 | 13.5 | 18 | 20 | 23 |
| TMPC1206HP-150MG-D | 15.0 | 9.0 | 13 | 16 | 25 | 29 |
| TMPC1206HP-180MG-D | 18.0 | 8.5 | 12 | 15 | 30 | 35 |
| TMPC1206HP-220MG-D | 22.0 | 8.0 | 11 | 14 | 34 | 39.5 |
| TMPC1206HP-270MG-D | 27.0 | 7.0 | 9.0 | 13 | 49 | 56 |
| TMPC1206HP-330MG-D | 33.0 | 6.0 | 8.0 | 12.0 | 65 | 75 |
| TMPC1206HP-470MG-D | 47.0 | 5.5 | 7.0 | 11.0 | 80 | 90 |
| TMPC1206HP-560MG-D | 56.0 | 5.3 | 6.5 | 10 | 101 | 118 |
| TMPC1206HP-680MG-D | 68.0 | 5.0 | 6.0 | 9.0 | 120 | 140 |
| TMPC1206HP-820MG-D | 82.0 | 4.5 | 5.5 | 8.5 | 138 | 161 |
| TMPC1206HP-101MG-D | 100 | 4.0 | 5.0 | 8.0 | 180 | 200 |
| TMPC1206HP-121MG-D | 120 | 3.5 | 4.5 | 7.0 | 210 | 235 |
| TMPC1206HP-151MG-D | 150 | 3.0 | 4.0 | 6.0 | 300 | 350 |

Note:

1. Test frequency : L : 100KHz /1.0V;
2. All test data referenced to 25°C ambient.
3. Testing Instrument : L/Q: HP4284A,CH11025,CH3302,CH1320 ,CH1320S LCR METER / Rdc:CH16502,Agilent33420A MICRO OHMMETER.
4. Heat Rated Current (I rms) will cause the coil temperature rise approximately Δt of 40°C (keep 1min.).
5. Saturation Current (I sat 1) will cause L0 to drop 20% typical. (keep quickly).
6. Saturation Current (I sat 2) will cause L0 to drop 30% typical. (keep quickly)
7. The part temperature (ambient + temp rise) should not exceed 125°C under worst case operating conditions. Circuit design, component, PCB trace size and thickness, airflow and other cooling provisions all affect the part temperature. Part temperature should be verified in the end application.
8. Special inquiries besides the above common used types can be met on your requirement.

6. Material List

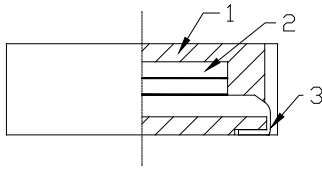

| NO | Items | Materials |
|----|----------------|-------------------------------|
| 1 | Core | Carbonyl Powder. |
| 2 | Wire | Polyester Wire or equivalent. |
| 3 | Solder Plating | 100% Pb free solder |

7. Reliability and Test Condition

| Item | Performance | Test Condition | | | | | | | | | | | | | | | |
|------------------------------------|---|--|--------------------------|------------------|----------------------------|-----------|----------------------------|-----|------|-----|-----------|------|------|-----|---|-----------|------|
| Operating temperature | -40~+125℃ | | | | | | | | | | | | | | | | |
| Storage temperature | -40~+125℃ (on board) | | | | | | | | | | | | | | | | |
| Electrical Performance Test | | | | | | | | | | | | | | | | | |
| Inductance | Refer to standard electrical characteristics list. | HP4284A, CH11025, CH3302, CH1320, CH1320S LCR Meter. | | | | | | | | | | | | | | | |
| DCR | | CH16502, Agilent33420A Micro-Ohm Meter. | | | | | | | | | | | | | | | |
| Saturation Current (Isat) | $\Delta L \leq 20\%$ typical. | Saturation DC Current (Isat) will cause L0 to drop $\Delta L(\%)$ (keep quickly). | | | | | | | | | | | | | | | |
| Heat Rated Current (Irms) | Approximately $\Delta T \leq 40^\circ\text{C}$ | Heat Rated Current (Irms) will cause the coil temperature rise $\Delta T(^\circ\text{C})$ without core loss. 1. Applied the allowed DC current(keep 1 min.). 2. Temperature measured by digital surface thermometer | | | | | | | | | | | | | | | |
| Reliability Test | | | | | | | | | | | | | | | | | |
| Life Test | Appearance : No damage. Inductance : within $\pm 10\%$ of initial value Q : Shall not exceed the specification value. RDC : within $\pm 15\%$ of initial value and shall not exceed the specification value | Preconditioning: Run through IR reflow for 2 times.(IPC/JEDEC J-STD-020D Classification Reflow Profiles) Temperature : 125 $\pm 2^\circ\text{C}$ (Bead) Temperature : 85 $\pm 2^\circ\text{C}$ (Inductor) Applied current : rated current Duration : 1000 ± 12 hrs Measured at room temperature after placing for 24 ± 2 hrs | | | | | | | | | | | | | | | |
| Load Humidity | | Preconditioning: Run through IR reflow for 2 times.(IPC/JEDEC J-STD-020D Classification Reflow Profiles) Humidity : 85 $\pm 2\%$ R.H., Temperature : 85 $\pm 2^\circ\text{C}$ Duration : 1000hrs Min. with 100% rated current Measured at room temperature after placing for 24 ± 2 hrs | | | | | | | | | | | | | | | |
| Thermal shock | | Preconditioning: Run through IR reflow for 2 times.(IPC/JEDEC J-STD-020D Classification Reflow Profiles) Condition for 1 cycle Step1 : -40 $\pm 2^\circ\text{C}$ 30 ± 5 min Step2 : 25 $\pm 2^\circ\text{C}$ ≤ 0.5 min Step3 : 105 $\pm 2^\circ\text{C}$ 30 ± 5 min Number of cycles : 500 Measured at room temperature after placing for 24 ± 2 hrs | | | | | | | | | | | | | | | |
| Vibration | | Oscillation Frequency: 10 ~ 2K ~ 10Hz for 20 minutes Equipment : Vibration checker Total Amplitude: 1.52mm $\pm 10\%$ Testing Time : 12 hours(20 minutes, 12 cycles each of 3 orientations). | | | | | | | | | | | | | | | |
| Shock | | <table border="1"> <thead> <tr> <th>Type</th> <th>Peak value (g's)</th> <th>Normal duration (D) (ms)</th> <th>Wave form</th> <th>Velocity change (Vi)ft/sec</th> </tr> </thead> <tbody> <tr> <td>SMD</td> <td>1500</td> <td>0.5</td> <td>Half-sine</td> <td>15.4</td> </tr> <tr> <td>Lead</td> <td>100</td> <td>6</td> <td>Half-sine</td> <td>12.3</td> </tr> </tbody> </table> | Type | Peak value (g's) | Normal duration (D) (ms) | Wave form | Velocity change (Vi)ft/sec | SMD | 1500 | 0.5 | Half-sine | 15.4 | Lead | 100 | 6 | Half-sine | 12.3 |
| Type | | Peak value (g's) | Normal duration (D) (ms) | Wave form | Velocity change (Vi)ft/sec | | | | | | | | | | | | |
| SMD | 1500 | 0.5 | Half-sine | 15.4 | | | | | | | | | | | | | |
| Lead | 100 | 6 | Half-sine | 12.3 | | | | | | | | | | | | | |
| Bending | Shall be mounted on a FR4 substrate of the following dimensions: $\geq 0805: 40 \times 100 \times 1.2\text{mm}$ $< 0805: 40 \times 100 \times 0.8\text{mm}$ Bending depth: $\geq 0805: 1.2\text{mm}$ $< 0805: 0.8\text{mm}$ duration of 10 sec. | | | | | | | | | | | | | | | | |

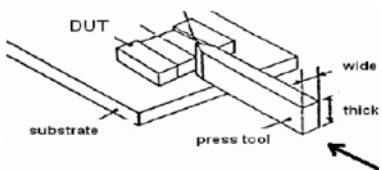
| Item | Performance | Test Method and Remarks | | | | | | |
|------------------------------|---|---|------------------|---------|--|---------------------|-------|----------------|
| Soderability | More than 95% of the terminal electrode should be covered with solder. | Preheat: 150°C, 60sec. Solder: Sn99.5%-Cu0.5%. Temperature: 245±5°C. Flux for lead free: Rosin. 9.5%. Dip time: 4±1sec. Depth: completely cover the termination | | | | | | |
| Resistance to Soldering Heat | | Number of heat cycles: 1 <table border="1"> <tr> <th>Temperature (°C)</th> <th>Time(s)</th> <th>Temperature ramp/immersion and emersion rate</th> </tr> <tr> <td>260 ±5(solder temp)</td> <td>10 ±1</td> <td>25mm/s ±6 mm/s</td> </tr> </table> | Temperature (°C) | Time(s) | Temperature ramp/immersion and emersion rate | 260 ±5(solder temp) | 10 ±1 | 25mm/s ±6 mm/s |
| Temperature (°C) | Time(s) | Temperature ramp/immersion and emersion rate | | | | | | |
| 260 ±5(solder temp) | 10 ±1 | 25mm/s ±6 mm/s | | | | | | |
| Terminal Strength | Appearance : No damage. Inductance : within±10% of initial value Q : Shall not exceed the specification value. RDC : within ±15% of initial value and shall not exceed the specification value | Preconditioning: Run through IR reflow for 2 times.(IPC/JEDEC J-STD-020DClassification Reflow Profiles With the component mounted on a PCB with the device to be tested, apply a force (>0.805:1kg , <=0.805:0.5kg)to the side of a device being tested. This force shall be applied for 60 +1 seconds. Also the force shall be applied gradually as not to apply a shock to the component being tested.  | | | | | | |

8. Soldering and Mounting

(1) Soldering

Mildly activated rosin fluxes are preferred. The minimum amount of solder can lead to damage from the stresses caused by the difference in coefficients of expansion between solder, chip and substrate. TAI-TECH terminations are suitable for re-flow soldering systems. If hand soldering cannot be avoided, the preferred technique is the utilization of hot air soldering tools.

(2) Solder re-flow:

Recommended temperature profiles for re-flow soldering in Figure 1.

(3) Soldering Iron:

Products attachment with a soldering iron is discouraged due to the inherent process control limitations. In the event that a soldering iron must be employed the following precautions are recommended.

- Preheat circuit and products to 150°C
- Never contact the ceramic with the i
- 355°C tip temperature (max)
- 1.0mm tip diameter (max)

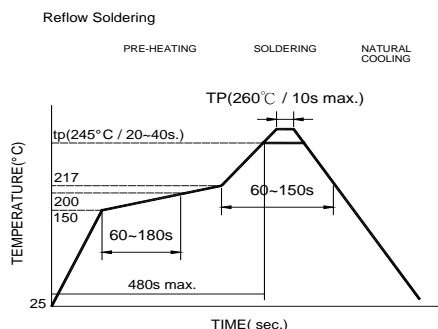

Reflow times: 3 times max.

Fig.1

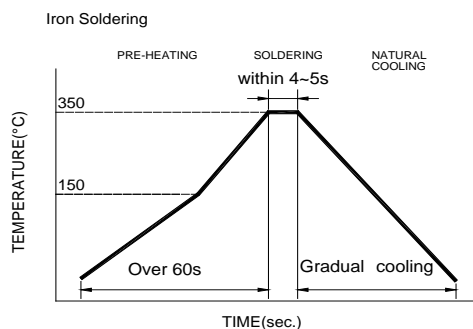

Iron Soldering times: 1 times max.

Fig.2

9. Packaging Information

(1) Reel Dimension

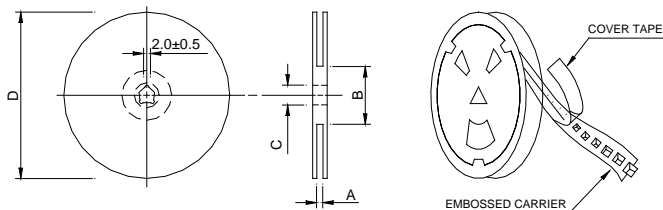

| Type | A(mm) | B(mm) | C(mm) | D(mm) |
|----------|----------|-------|----------|-------|
| 13"x24mm | 24.0±0.5 | 100±2 | 13.5±0.5 | 330 |

(2) Tape Dimension

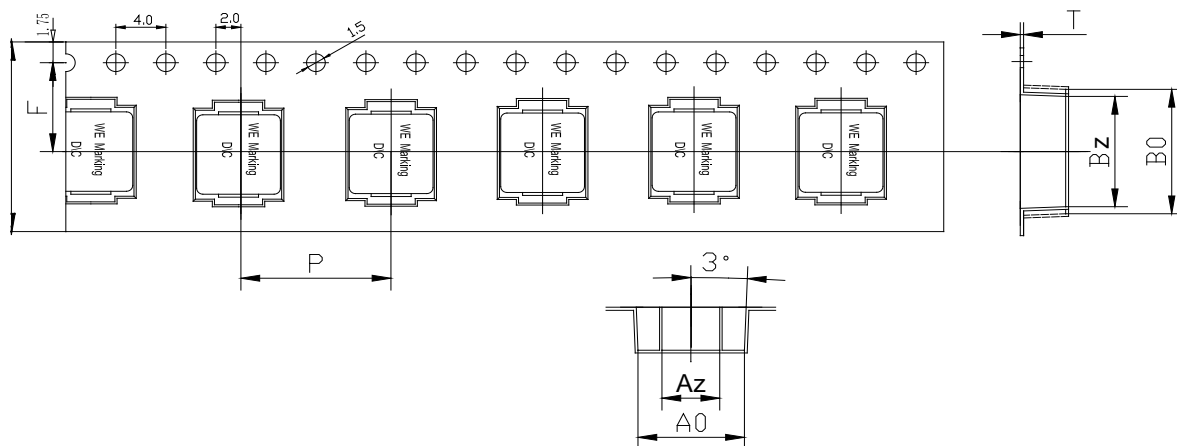

| Series | Size | Bo(mm) | Bz(mm) | Ao(mm) | Az(mm) | Ko(mm) | P(mm) | W(mm) | F(mm) | t(mm) |
|--------|------|----------|----------|----------|---------|---------|----------|--------|----------|-----------|
| TMPC | 1206 | 14.2±0.1 | 13.0±0.1 | 13.0±0.1 | 7.0±0.1 | 6.5±0.1 | 16.0±0.1 | 24±0.3 | 11.5±0.1 | 0.35±0.05 |

(3) Packaging Quantity

| TMPC | 1206 |
|-------------|------|
| Chip / Reel | 500 |
| Inner box | 1000 |
| Carton | 4000 |

(4) Tearing Off Force

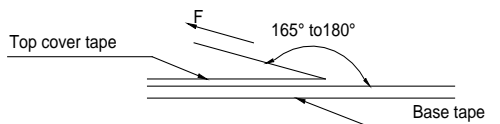

The force for tearing off cover tape is 10 to 130 grams in the arrow direction under the following conditions(referenced ANSI/EIA-481-C-2003 of 4.11 stadnard).

| Room Temp. (°C) | Room Humidity (%) | Room atm (hPa) | Tearing Speed mm/min |
|------------------|-------------------|----------------|----------------------|
| 5~35 | 45~85 | 860~1060 | 300 |

Application Notice

- Storage Conditions (component level)
To maintain the solderability of terminal electrodes:
 1. TAI-TECH products meet IPC/JEDEC J-STD-020D standard-MSL, level 1.
 2. Temperature and humidity conditions: Less than 40°C and 60% RH.
 3. Recommended products should be used within 12 months form the time of delivery.
 4. The packaging material should be kept where no chlorine or sulfur exists in the air.
- Transportation
 1. Products should be handled with care to avoid damage or contamination from perspiration and skin oils.
 2. The use of tweezers or vacuum pick up is strongly recommended for individual components.
 3. Bulk handling should ensure that abrasion and mechanical shock are minimized.

10. Typical Performance Curves

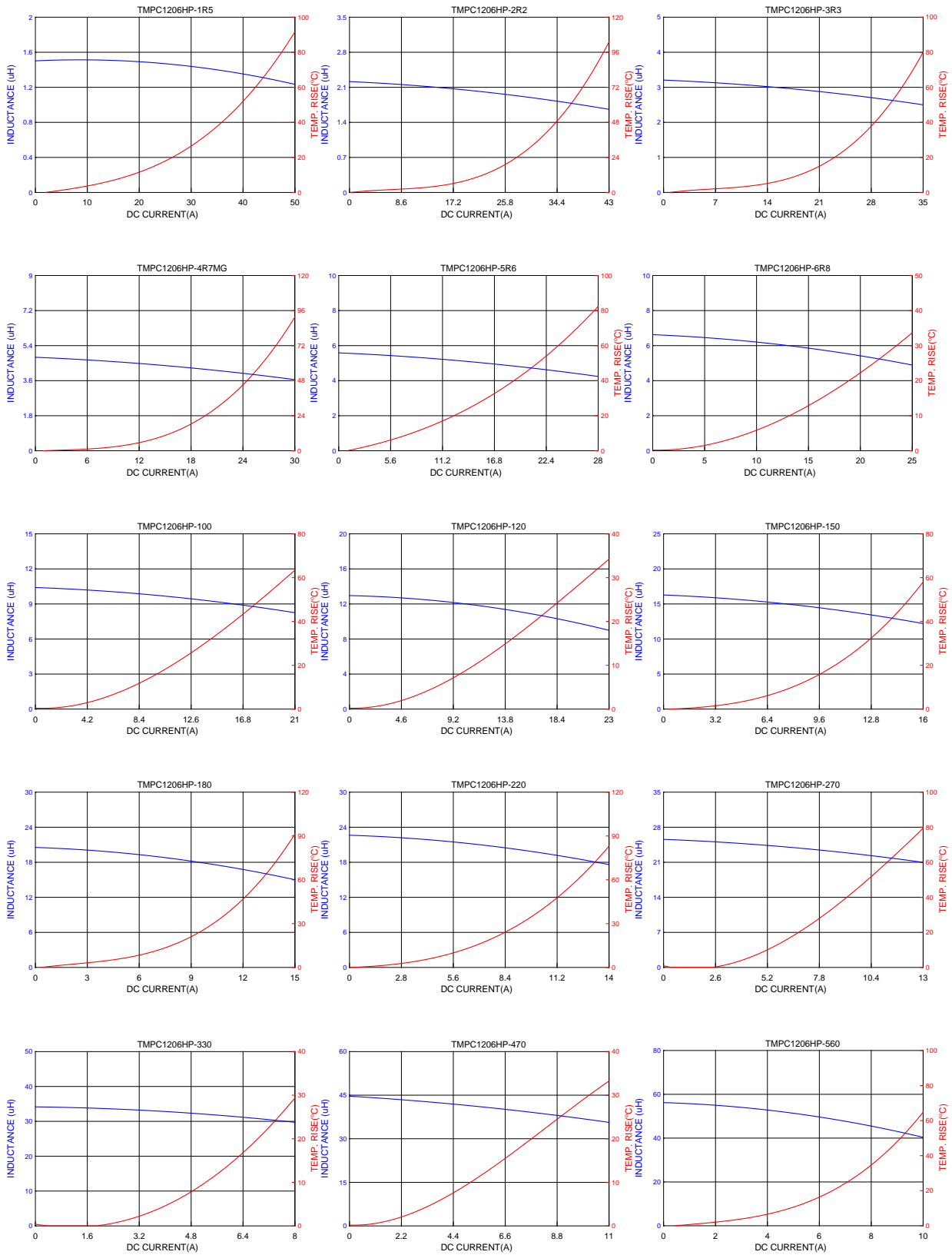

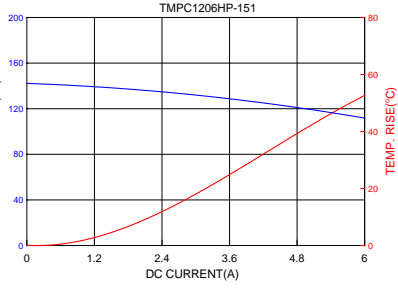
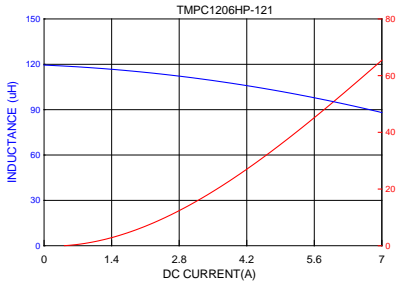
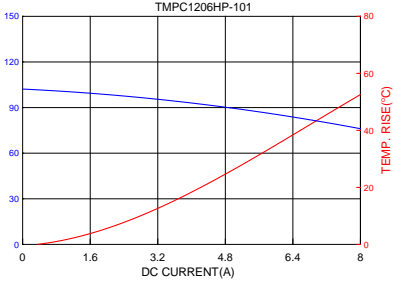
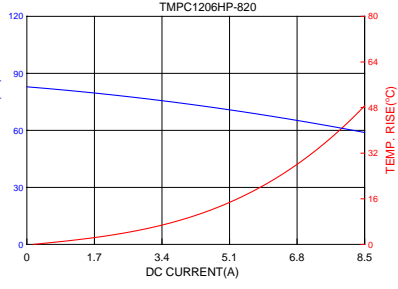
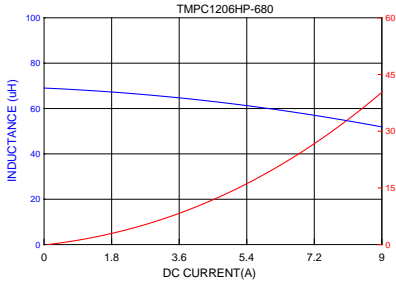

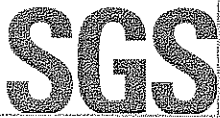

簽名有效
For Question
Please Contact with SGS
www.tw.sgs.com

測試報告

Test Report

號碼(No.) : CE/2014/14393 日期(Date) : 2014/01/24 頁數(Page) : 1 of 13

西北臺慶科技股份有限公司 / TAI-TECH ADVANCED ELECTRONICS CO., LTD. 

(東莞臺慶精密電子有限公司 / TAI-TECH ADVANCED ELECTRONICS (DONGGUAN) CO. LTD.)

(臺慶精密電子(昆山)有限公司 / TAI-TECH ADVANCED ELECTRONICS (KUN-SHAN) CO. LTD.)

(耀鑽科技股份有限公司 / YOSONIC TECHNOLOGY CO., LTD.)

桃園縣楊梅市幼獅工業區幼四路1號 / NO. 1, YOU 4TH ROAD, YOUTH INDUSTRIAL DISTRICT, YANG-MEI CITY, TAO-YUAN HSIEN. TAIWAN R. O. C.

(廣東省東莞市黃江鎮黃牛埔福祥街2號 / NO. 2, FUXIANG STREET, HUANGNIUPOU, HUANGJIANG TOWN, DONGGUAN, GUANGDONG)

(江蘇省昆山市蓬朗昆嘉高科技工業區郭澤路 / GUO-ZE ROAD, KUNJIA HI-TECH INDUSTRIAL PARK, KUN-SHAN, JIANG-SU, CHINA)

(桃園縣中壢市中壢工業區長春六路15號 / NO. 15, CHANGCHUN 6TH RD., JHONGLI CITY, TAOYUAN COUNTY 320, TAIWAN (R. O. C.))

以下測試樣品係由申請廠商所提供及確認 (The following sample(s) was/were submitted and identified by/on behalf of the applicant as) :

樣品名稱(Sample Description) : SMD POWER INDUCTOR

樣品型號(Style/Item No.) : TMPB, TMPC, SLPI, SMPI, SMPI-P3, EPI(ePI), VMPI, MLPI SERIES

收件日期(Sample Receiving Date) : 2014/01/20

測試期間(Testing Period) : 2014/01/20 TO 2014/01/24

=====

測試結果(Test Results) : 請見下一頁 (Please refer to next pages).

Troy Chang, Manager Tech
Signed for and on behalf of
SGS TAIWAN LTD
Chemical Laboratory - Taipei

This document is issued by the Company subject to its General Conditions of Service printed overleaf, available on request or accessible at <http://www.sgs.com.tw/Forms-and-Conditions.asp> and, for electronic format documents, subject to Terms and Conditions for Electronic Documents at <http://www.sgs.com.tw/terms-and-conditions/Forms-and-Conditions.asp>. Attention is drawn to the limitation of liability, indemnification and jurisdiction issues defined therein. Any holder of this document is advised that information contained hereon reflects the Company's findings at the time of its intervention only and within the limits of client's instruction, if any. The Company's sole responsibility is to its Client and this document does not exonerate parties to a transaction from exercising all their rights and obligations under the transaction documents. This document cannot be reproduced, except in full, without prior written approval of the Company. Any unauthorized alteration, forgery or falsification of the content or appearance of this document is unlawful and offenders may be prosecuted to the fullest extent of the law. Unless otherwise stated the results shown in this test report refer only to the sample(s) tested.



測試報告

Test Report

號碼(No.) : CE/2014/14393 日期(Date) : 2014/01/24 頁數(Page) : 2 of 13

西北臺慶科技股份有限公司 / TAI-TECH ADVANCED ELECTRONICS CO., LTD.



(東莞臺慶精密電子有限公司 / TAI-TECH ADVANCED ELECTRONICS (DONGGUAN) CO. LTD.)

(臺慶精密電子(昆山)有限公司 / TAI-TECH ADVANCED ELECTRONICS (KUN-SHAN) CO. LTD.)

(耀鑽科技股份有限公司 / YOSONIC TECHNOLOGY CO., LTD.)

桃園縣楊梅市幼獅工業區幼四路1號 / NO. 1, YOU 4TH ROAD, YOUTH INDUSTRIAL DISTRICT, YANG-MEI CITY, TAO-YUAN HSIEN. TAIWAN R. O. C.

(廣東省東莞市黃江鎮黃牛埔福祥街2號 / NO. 2, FUXIANG STREET, HUANGNIUPU, HUANGJIANG TOWN, DONGGUAN, GUANGDONG)

(江蘇省昆山市蓬朗昆嘉高科技工業區郭澤路 / GUO-ZE ROAD, KUNJIA HI-TECH INDUSTRIAL PARK, KUN-SHAN, JIANG-SU, CHINA)

(桃園縣中壢市中壢工業區長春六路15號 / NO. 15, CHANGCHUN 6TH RD., JHONGLI CITY, TAOYUAN COUNTY 320, TAIWAN (R. O. C.))

測試結果(Test Results)

測試部位(PART NAME)No.1 : 整體混測 (MIXED ALL PARTS)

| 測試項目 (Test Items) | 單位 (Unit) | 測試方法 (Method) | 方法偵測 極限值 (MDL) | 結果 (Result) |
|----------------------------------|--------------|---|----------------------|----------------|
| | | | | No.1 |
| 鎘 / Cadmium (Cd) | mg/kg | 參考IEC 62321-5: 2013方法, 以感應耦合電漿原子發射光譜儀檢測. / With reference to IEC 62321-5: 2013 and performed by ICP-AES. | 2 | n.d. |
| 鉛 / Lead (Pb) | mg/kg | 參考IEC 62321-5: 2013方法, 以感應耦合電漿原子發射光譜儀檢測. / With reference to IEC 62321-5: 2013 and performed by ICP-AES. | 2 | n.d. |
| 汞 / Mercury (Hg) | mg/kg | 參考IEC 62321-4: 2013方法, 以感應耦合電漿原子發射光譜儀檢測. / With reference to IEC 62321-4: 2013 and performed by ICP-AES. | 2 | n.d. |
| 六價鉻 / Hexavalent Chromium Cr(VI) | mg/kg | 參考IEC 62321: 2008方法, 以UV-VIS檢測. / With reference to IEC 62321: 2008 and performed by UV-VIS. | 2 | n.d. |
| 銻 / Antimony (Sb) | mg/kg | 參考US EPA 3052方法, 以感應耦合電漿原子發射光譜儀檢測. / With reference to US EPA Method 3052. Analysis was performed by ICP-AES. | 2 | n.d. |

This document is issued by the Company subject to its General Conditions of Service printed overleaf, available on request or accessible at <http://www.sgs.com.tw/Terms-and-Conditions.aspx> and, for electronic format documents, subject to Terms and Conditions for Electronic Documents at <http://www.sgs.com.tw/Terms-and-Conditions/Terms-Document.aspx>. Attention is drawn to the limitation of liability, indemnification and jurisdiction issues defined therein. Any holder of this document is advised that information contained hereon reflects the Company's findings at the time of its intervention only and within the limits of client's instruction, if any. The Company's sole responsibility is to its Client and this document does not exonerate parties to a transaction from exercising all their rights and obligations under the transaction documents. This document cannot be reproduced, except in full, without prior written approval of the Company. Any unauthorized alteration, forgery or falsification of the content or appearance of this document is unlawful and offenders may be prosecuted to the fullest extent of the law. Unless otherwise stated the results shown in this test report refer only to the sample(s) tested.



測試報告

Test Report

號碼(No.) : CE/2014/14393 日期(Date) : 2014/01/24 頁數(Page) : 3 of 13

西北臺慶科技股份有限公司 / TAI-TECH ADVANCED ELECTRONICS CO., LTD.



(東莞臺慶精密電子有限公司 / TAI-TECH ADVANCED ELECTRONICS (DONGGUAN) CO. LTD.)

(臺慶精密電子(昆山)有限公司 / TAI-TECH ADVANCED ELECTRONICS (KUN-SHAN) CO. LTD.)

(耀鑽科技股份有限公司 / YOSONIC TECHNOLOGY CO., LTD.)

桃園縣楊梅市幼獅工業區幼四路1號 / NO. 1, YOU 4TH ROAD, YOUTH INDUSTRIAL DISTRICT, YANG-MEI CITY, TAO-YUAN HSIEN. TAIWAN R. O. C.

(廣東省東莞市黃江鎮黃牛埔福祥街2號 / NO. 2, FUXIANG STREET, HUANGNIUPU, HUANGJIANG TOWN, DONGGUAN, GUANGDONG)

(江蘇省昆山市蓬朗昆嘉高科技工業區郭澤路 / GUO-ZE ROAD, KUNJIA HI-TECH INDUSTRIAL PARK, KUN-SHAN, JIANG-SU, CHINA)

(桃園縣中壢市中壢工業區長春六路15號 / NO. 15, CHANGCHUN 6TH RD., JHONGLI CITY, TAOYUAN COUNTY 320, TAIWAN (R. O. C.))

| 測試項目 (Test Items) | 單位 (Unit) | 測試方法 (Method) | 方法偵測 極限值 (MDL) | 結果 (Result) |
|---|--------------|--|----------------------|----------------|
| | | | | No.1 |
| 鄰苯二甲酸甲苯基丁酯 / BBP (Benzyl butyl phthalate) (CAS No.: 85-68-7) | % | 參考EN 14372, 以氣相層析/質譜儀檢測之。 / With reference to EN 14372. Analysis was performed by GC/MS. | 0.003 | n.d. |
| 鄰苯二甲酸二(2-乙基己基)酯 / DEHP (Di- (2-ethylhexyl) phthalate) (CAS No.: 117-81-7) | % | 參考EN 14372, 以氣相層析/質譜儀檢測之。 / With reference to EN 14372. Analysis was performed by GC/MS. | 0.003 | n.d. |
| 鄰苯二甲酸二異癸酯 / DIDP (Di- isodecyl phthalate) (CAS No.: 26761-40-0; 68515-49-1) | % | 參考EN 14372, 以氣相層析/質譜儀檢測之。 / With reference to EN 14372. Analysis was performed by GC/MS. | 0.01 | n.d. |
| 鄰苯二甲酸二異壬酯 / DINP (Di- isononyl phthalate) (CAS No.: 28553-12-0; 68515-48-0) | % | 參考EN 14372, 以氣相層析/質譜儀檢測之。 / With reference to EN 14372. Analysis was performed by GC/MS. | 0.01 | n.d. |
| 鄰苯二甲酸二正辛酯 / DNOP (Di-n- octyl phthalate) (CAS No.: 117- 84-0) | % | 參考EN 14372, 以氣相層析/質譜儀檢測之。 / With reference to EN 14372. Analysis was performed by GC/MS. | 0.003 | n.d. |
| 鄰苯二甲酸二丁酯 / DBP (Dibutyl phthalate) (CAS No.: 84-74-2) | % | 參考EN 14372, 以氣相層析/質譜儀檢測之。 / With reference to EN 14372. Analysis was performed by GC/MS. | 0.003 | n.d. |
| 鄰苯二甲酸二異丁酯 / DIEP (Di- isobutyl phthalate) (CAS No.: 84- 69-5) | % | 參考EN 14372, 以氣相層析/質譜儀檢測之。 / With reference to EN 14372. Analysis was performed by GC/MS. | 0.003 | n.d. |

This document is issued by the Company subject to its General Conditions of Service printed overleaf, available on request or accessible at <http://www.sgs.com/en/Terms-and-Conditions.aspx> and, for electronic format documents, subject to Terms and Conditions for Electronic Documents at <http://www.sgs.com/en/Terms-and-Conditions/Electronic-Documents.aspx>. Attention is drawn to the limitation of liability, indemnification and jurisdiction issues defined therein. Any holder of this document is advised that information contained hereon reflects the Company's findings at the time of its intervention only and within the limits of client's instruction, if any. The Company's sole responsibility is to its Client and this document does not exonerate parties to a transaction from exercising all their rights and obligations under the transaction documents. This document cannot be reproduced, except in full, without prior written approval of the Company. Any unauthorized alteration, forgery or falsification of the content or appearance of this document is unlawful and offenders may be prosecuted to the fullest extent of the law. Unless otherwise stated the results shown in this test report refer only to the sample(s) tested.



測試報告

Test Report

號碼(No.) : CE/2014/14393 日期(Date) : 2014/01/24 頁數(Page) : 4 of 13

西北臺慶科技股份有限公司 / TAI-TECH ADVANCED ELECTRONICS CO., LTD.



(東莞臺慶精密電子有限公司 / TAI-TECH ADVANCED ELECTRONICS (DONGGUAN) CO. LTD.)

(臺慶精密電子(昆山)有限公司 / TAI-TECH ADVANCED ELECTRONICS (KUN-SHAN) CO. LTD.)

(耀鑽科技股份有限公司 / YOSONIC TECHNOLOGY CO., LTD.)

桃園縣楊梅市幼獅工業區幼四路1號 / NO. 1, YOU 4TH ROAD, YOUTH INDUSTRIAL DISTRICT, YANG-MEI CITY, TAO-YUAN HSIEN, TAIWAN R. O. C.

(廣東省東莞市黃江鎮黃牛埔福祥街2號 / NO. 2, FUXIANG STREET, HUANGNIUPU, HUANGJIANG TOWN, DONGGUAN, GUANGDONG)

(江蘇省昆山市蓬朗昆嘉高科技工業區郭澤路 / GUO-ZE ROAD, KUNJIA HI-TECH INDUSTRIAL PARK, KUN-SHAN, JIANG-SU, CHINA)

(桃園縣中壢市中壢工業區長春六路15號 / NO. 15, CHANGCHUN 6TH RD., JHONGLI CITY, TAOYUAN COUNTY 320, TAIWAN (R. O. C.))

| 測試項目 (Test Items) | 單位 (Unit) | 測試方法 (Method) | 方法偵測 極限值 (MDL) | 結果 (Result) |
|--|--------------|--|----------------------|----------------|
| | | | | No.1 |
| 六溴環十二烷及所有主要被辨別出的異構物 / Hexabromocyclododecane (HBCDD) and all major diastereoisomers identified (α -HBCDD, β -HBCDD, γ -HBCDD) (CAS No.: 25637-99-4 and 3194-55-6 (134237-51-7, 134237-50-6, 134237-52-8)) | mg/kg | 參考IEC 62321: 2008方法, 以氣相層析/質譜儀檢測. / With reference to IEC 62321: 2008 method. Analysis was performed by GC/MS. | 5 | n.d. |
| 多溴聯苯總和 / Sum of PBBs | mg/kg | 參考IEC 62321: 2008方法, 以氣相層析/質譜儀檢測. / With reference to IEC 62321: 2008 and performed by GC/MS. | - | n.d. |
| 一溴聯苯 / Monobromobiphenyl | mg/kg | | 5 | n.d. |
| 二溴聯苯 / Dibromobiphenyl | mg/kg | | 5 | n.d. |
| 三溴聯苯 / Tribromobiphenyl | mg/kg | | 5 | n.d. |
| 四溴聯苯 / Tetrabromobiphenyl | mg/kg | | 5 | n.d. |
| 五溴聯苯 / Pentabromobiphenyl | mg/kg | | 5 | n.d. |
| 六溴聯苯 / Hexabromobiphenyl | mg/kg | | 5 | n.d. |
| 七溴聯苯 / Heptabromobiphenyl | mg/kg | | 5 | n.d. |
| 八溴聯苯 / Octabromobiphenyl | mg/kg | | 5 | n.d. |
| 九溴聯苯 / Nonabromobiphenyl | mg/kg | | 5 | n.d. |
| 十溴聯苯 / Decabromobiphenyl | mg/kg | 5 | n.d. | |

This document is issued by the Company subject to its General Conditions of Service printed overleaf, available on request or accessible at <http://www.sgs.com.tw/terms-and-conditions.aspx> and, for electronic format documents, subject to Terms and Conditions for Electronic Documents at <http://www.sgs.com.tw/terms-and-conditions/Electronic-Documents.aspx>. Attention is drawn to the limitation of liability, indemnification and jurisdiction issues defined therein. Any holder of this document is advised that information contained hereon reflects the Company's findings at the time of its intervention only and within the limits of client's instruction, if any. The Company's sole responsibility is to its Client and this document does not exonerate parties to a transaction from exercising all their rights and obligations under the transaction documents. This document cannot be reproduced, except in full, without prior written approval of the Company. Any unauthorized alteration, forgery or falsification of the content or appearance of this document is unlawful and offenders may be prosecuted to the fullest extent of the law. Unless otherwise stated the results shown in this test report refer only to the sample(s) tested.



測試報告

Test Report

號碼(No.) : CE/2014/14393 日期(Date) : 2014/01/24 頁數(Page) : 5 of 13

西北臺慶科技股份有限公司 / TAI-TECH ADVANCED ELECTRONICS CO., LTD.



(東莞臺慶精密電子有限公司 / TAI-TECH ADVANCED ELECTRONICS (DONGGUAN) CO. LTD.)

(臺慶精密電子(昆山)有限公司 / TAI-TECH ADVANCED ELECTRONICS (KUN-SHAN) CO. LTD.)

(耀鑽科技股份有限公司 / YOSONIC TECHNOLOGY CO., LTD.)

桃園縣楊梅市幼獅工業區幼四路1號 / NO. 1, YOU 4TH ROAD, YOUTH INDUSTRIAL DISTRICT, YANG-MEI CITY, TAO-YUAN HSIEN. TAIWAN R. O. C.

(廣東省東莞市黃江鎮黃牛埔福祥街2號 / NO. 2, FUXIANG STREET, HUANGNIUPU, HUANGJIANG TOWN, DONGGUAN, GUANGDONG)

(江蘇省昆山市蓬朗昆嘉高科技工業區郭澤路 / GUO-ZE ROAD, KUNJIA HI-TECH INDUSTRIAL PARK, KUN-SHAN, JIANG-SU, CHINA)

(桃園縣中壢市中壢工業區長春六路15號 / NO. 15, CHANGCHUN 6TH RD., JHONGLI CITY, TAOYUAN COUNTY 320, TAIWAN (R. O. C.))

| 測試項目 (Test Items) | 單位 (Unit) | 測試方法 (Method) | 方法偵測 極限值 (MDL) | 結果 (Result) |
|--|--------------|---|----------------------|----------------|
| | | | | No.1 |
| 多溴聯苯醚總和 / Sum of PBDEs | mg/kg | 參考IEC 62321: 2008方法, 以氣相層析/質譜儀檢測. / With reference to IEC 62321: 2008 and performed by GC/MS. | - | n.d. |
| 一溴聯苯醚 / Monobromodiphenyl ether | mg/kg | | 5 | n.d. |
| 二溴聯苯醚 / Dibromodiphenyl ether | mg/kg | | 5 | n.d. |
| 三溴聯苯醚 / Tribromodiphenyl ether | mg/kg | | 5 | n.d. |
| 四溴聯苯醚 / Tetrabromodiphenyl ether | mg/kg | | 5 | n.d. |
| 五溴聯苯醚 / Pentabromodiphenyl ether | mg/kg | | 5 | n.d. |
| 六溴聯苯醚 / Hexabromodiphenyl ether | mg/kg | | 5 | n.d. |
| 七溴聯苯醚 / Heptabromodiphenyl ether | mg/kg | | 5 | n.d. |
| 八溴聯苯醚 / Octabromodiphenyl ether | mg/kg | | 5 | n.d. |
| 九溴聯苯醚 / Nonabromodiphenyl ether | mg/kg | | 5 | n.d. |
| 十溴聯苯醚 / Decabromodiphenyl ether | mg/kg | 5 | n.d. | |
| 鹵素 / Halogen | | | | |
| 鹵素(氟) / Halogen-Fluorine (F) (CAS No.: 14762-94-8) | mg/kg | 參考BS EN 14582:2007, 以離子層析儀分析. / With reference to BS EN 14582:2007. Analysis was performed by IC. | 50 | n.d. |
| 鹵素(氯) / Halogen-Chlorine (Cl) (CAS No.: 22537-15-1) | mg/kg | | 50 | n.d. |
| 鹵素(溴) / Halogen-Bromine (Br) (CAS No.: 10097-32-2) | mg/kg | | 50 | n.d. |
| 鹵素(碘) / Halogen-Iodine (I) (CAS No.: 14362-44-8) | mg/kg | | 50 | n.d. |

This document is issued by the Company subject to its General Conditions of Service printed overleaf, available on request or accessible at <http://www.sgs.com/en/terms-and-conditions.aspx> and, for electronic format documents, subject to Terms and Conditions for Electronic Documents at <http://www.sgs.com/en/terms-and-conditions/terms-and-conditions.aspx>. Attention is drawn to the limitation of liability, indemnification and jurisdiction issues defined therein. Any holder of this document is advised that information contained hereon reflects the Company's findings at the time of its intervention only and within the limits of client's instruction, if any. The Company's sole responsibility is to its Client and this document does not exonerate parties to a transaction from exercising all their rights and obligations under the transaction documents. This document cannot be reproduced, except in full, without prior written approval of the Company. Any unauthorized alteration, forgery or falsification of the content or appearance of this document is unlawful and offenders may be prosecuted to the fullest extent of the law. Unless otherwise stated the results shown in this test report refer only to the sample(s) tested.



測試報告

Test Report

號碼(No.) : CE/2014/14393 日期(Date) : 2014/01/24 頁數(Page) : 6 of 13

西北臺慶科技股份有限公司 / TAI-TECH ADVANCED ELECTRONICS CO., LTD.



(東莞臺慶精密電子有限公司 / TAI-TECH ADVANCED ELECTRONICS (DONGGUAN) CO. LTD.)

(臺慶精密電子(昆山)有限公司 / TAI-TECH ADVANCED ELECTRONICS (KUN-SHAN) CO. LTD.)

(耀鑽科技股份有限公司 / YOSONIC TECHNOLOGY CO., LTD.)

桃園縣楊梅市幼獅工業區幼四路1號 / NO. 1, YOU 4TH ROAD, YOUTH INDUSTRIAL DISTRICT, YANG-MEI CITY, TAO-YUAN HSIEN. TAIWAN R. O. C.

(廣東省東莞市黃江鎮黃牛埔福祥街2號 / NO. 2, FUXIANG STREET, HUANGNIUPU, HUANGJIANG TOWN, DONGGUAN, GUANGDONG)

(江蘇省昆山市蓬朗昆嘉高科技工業區郭澤路 / GUO-ZE ROAD, KUNJIA HI-TECH INDUSTRIAL PARK, KUN-SHAN, JIANG-SU, CHINA)

(桃園縣中壢市中壢工業區長春六路15號 / NO. 15, CHANGCHUN 6TH RD., JHONGLI CITY, TAOYUAN COUNTY 320, TAIWAN (R. O. C.))

備註(Note) :

1. mg/kg = ppm ; 0.1wt% = 1000ppm
2. n.d. = Not Detected (未檢出)
3. MDL = Method Detection Limit (方法偵測極限值)
4. "-" = Not Regulated (無規格值)
5. 樣品的測試是基於申請人要求混合測試，報告中的混合測試結果不代表其中個別單一材質的含量。(The samples was/were analyzed on behalf of the applicant as mixing sample in one testing. The above results was/were only given as the informality value.)

This document is issued by the Company subject to its General Conditions of Service printed overleaf, available on request or accessible at <http://www.sgs.com/en/Terms and Conditions.aspx> and, for electronic format documents, subject to Terms and Conditions for Electronic Documents at <http://www.sgs.com/en/Terms and Conditions/Electronic Documents.aspx>. Attention is drawn to the limitation of liability, indemnification and jurisdiction issues defined therein. Any holder of this document is advised that information contained hereon reflects the Company's findings at the time of its intervention only and within the limits of client's instruction, if any. The Company's sole responsibility is to its Client and this document does not exonerate parties to a transaction from exercising all their rights and obligations under the transaction documents. This document cannot be reproduced, except in full, without prior written approval of the Company. Any unauthorized alteration, forgery or falsification of the content or appearance of this document is unlawful and offenders may be prosecuted to the fullest extent of the law. Unless otherwise stated the results shown in this test report refer only to the sample(s) tested.

測試報告 Test Report

號碼(No.) : CE/2014/14393 日期(Date) : 2014/01/24 頁數(Page) : 7 of 13

西北臺慶科技股份有限公司 / TAI-TECH ADVANCED ELECTRONICS CO., LTD.

(東莞臺慶精密電子有限公司 / TAI-TECH ADVANCED ELECTRONICS (DONGGUAN) CO. LTD.)

(臺慶精密電子(昆山)有限公司 / TAI-TECH ADVANCED ELECTRONICS (KUN-SHAN) CO. LTD.)

(耀鑽科技股份有限公司 / YOSONIC TECHNOLOGY CO., LTD.)

桃園縣楊梅市幼獅工業區幼四路1號 / NO. 1, YOU 4TH ROAD, YOUTH INDUSTRIAL DISTRICT, YANG-MEI CITY, TAO-YUAN HSIEN. TAIWAN R. O. C.

(廣東省東莞市黃江鎮黃牛埔福祥街2號 / NO. 2, FUXIANG STREET, HUANGNIUPU, HUANGJIANG TOWN, DONGGUAN, GUANGDONG)

(江蘇省昆山市蓬朗昆嘉高科技工業區郭澤路 / GUO-ZE ROAD, KUNJIA HI-TECH INDUSTRIAL PARK, KUN-SHAN, JIANG-SU, CHINA)

(桃園縣中壢市中壢工業區長春六路15號 / NO. 15, CHANGCHUN 6TH RD., JHONGLI CITY, TAOYUAN COUNTY 320, TAIWAN (R. O. C.))

- 1) 根據以下的流程圖之條件, 樣品已完全溶解。(六價鉻測試方法除外) / These samples were dissolved totally by pre-conditioning method according to below flow chart. (Cr⁶⁺ test method excluded)
- 2) 測試人員: 楊登偉 / Name of the person who made measurement: Climbgreat Yang
- 3) 測試負責人: 張啓興 / Name of the person in charge of measurement: Troy Chang

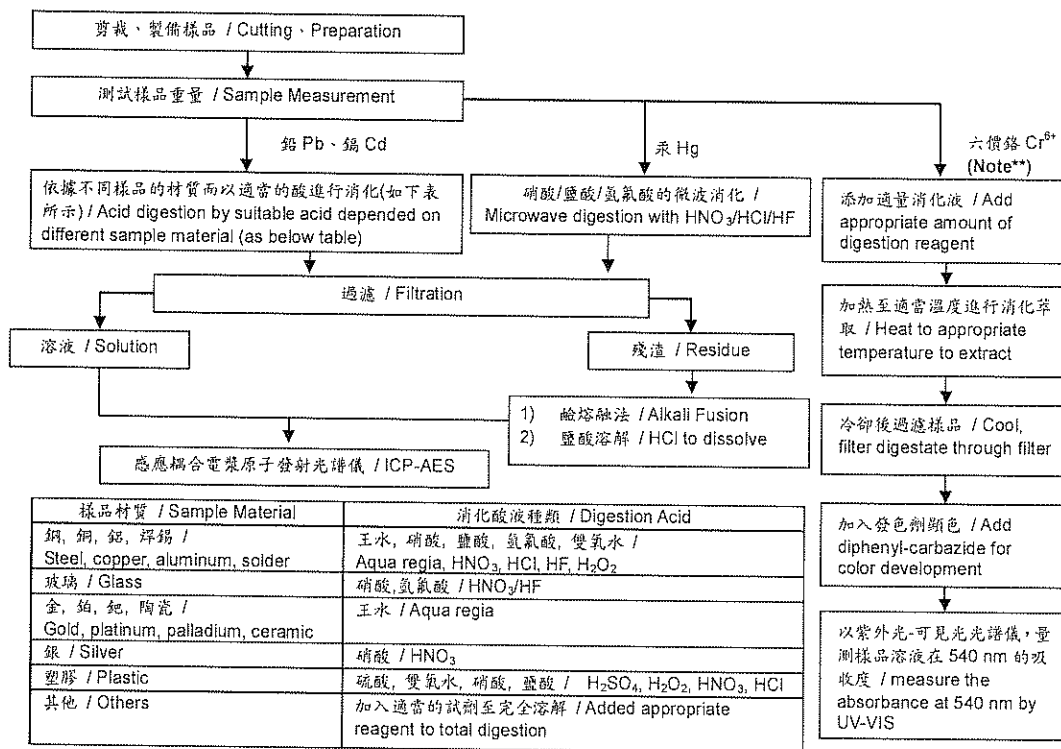

Note (For IEC 62321)**

- (1) 針對非金屬材料加入鹼性消化液, 加熱至 90~95℃ 萃取。 / For non-metallic material, add alkaline digestion reagent and heat to 90~95 °C.
- (2) 針對金屬材料加入純水, 加熱至沸騰萃取。 / For metallic material, add pure water and heat to boiling.



測試報告

Test Report

號碼(No.) : CE/2014/14393 日期(Date) : 2014/01/24 頁數(Page) : 8 of 13

西北臺慶科技股份有限公司 / TAI-TECH ADVANCED ELECTRONICS CO., LTD.



(東莞臺慶精密電子有限公司 / TAI-TECH ADVANCED ELECTRONICS (DONGGUAN) CO. LTD.)

(臺慶精密電子(昆山)有限公司 / TAI-TECH ADVANCED ELECTRONICS (KUN-SHAN) CO. LTD.)

(耀鑽科技股份有限公司 / YOSONIC TECHNOLOGY CO., LTD.)

桃園縣楊梅市幼獅工業區幼四路1號 / NO. 1, YOU 4TH ROAD, YOUTH INDUSTRIAL DISTRICT, YANG-MEI CITY, TAO-YUAN HSIEN. TAIWAN R. O. C.

(廣東省東莞市黃江鎮黃牛埔福祥街2號 / NO. 2, FUXIANG STREET, HUANGNIUPU, HUANGJIANG TOWN, DONGGUAN, GUANGDONG)

(江蘇省昆山市蓬朗昆嘉高科技工業區郭澤路 / GUO-ZE ROAD, KUNJIA HI-TECH INDUSTRIAL PARK, KUN-SHAN, JIANG-SU, CHINA)

(桃園縣中壢市中壢工業區長春六路15號 / NO. 15, CHANGCHUN 6TH RD., JHONGLI CITY, TAOYUAN COUNTY 320, TAIWAN (R. O. C.))

多溴聯苯/多溴聯苯醚分析流程圖 / PBB/PBDE analytical FLOW CHART

- 測試人員：翁賜彬 / Name of the person who made measurement: Roman Wong
- 測試負責人：張啓興 / Name of the person in charge of measurement: Troy Chang

初次測試程序 / First testing process —————>

選擇性篩檢程序 / Optional screen process>

確認程序 / Confirmation process - - ->

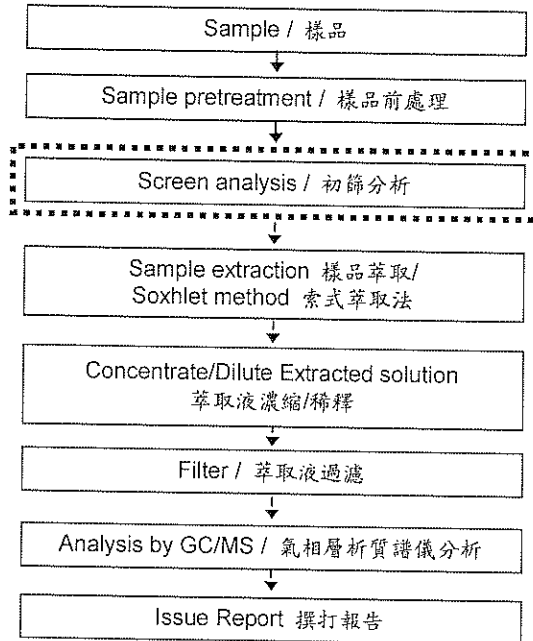

This document is issued by the Company subject to its General Conditions of Service printed overleaf, available on request or accessible at <http://www.sgs.com.tw/Forma-and-Conditions.aspx> and, for electronic format documents, subject to Terms and Conditions for Electronic Documents at <http://www.sgs.com.tw/terms-and-conditions/Terms-Conditions.aspx>. Attention is drawn to the limitation of liability, indemnification and jurisdiction issues defined therein. Any holder of this document is advised that information contained hereon reflects the Company's findings at the time of its intervention only and within the limits of client's instruction, if any. The Company's sole responsibility is to its Client and this document does not exonerate parties to a transaction from exercising all their rights and obligations under the transaction documents. This document cannot be reproduced, except in full, without prior written approval of the Company. Any unauthorized alteration, forgery or falsification of the content or appearance of this document is unlawful and offenders may be prosecuted to the fullest extent of the law. Unless otherwise stated the results shown in this test report refer only to the sample(s) tested.



測試報告 Test Report

號碼(No.) : CE/2014/14393 日期(Date) : 2014/01/24 頁數(Page) : 9 of 13

西北臺慶科技股份有限公司 / TAI-TECH ADVANCED ELECTRONICS CO., LTD.



(東莞臺慶精密電子有限公司 / TAI-TECH ADVANCED ELECTRONICS (DONGGUAN) CO. LTD.)

(臺慶精密電子(昆山)有限公司 / TAI-TECH ADVANCED ELECTRONICS (KUN-SHAN) CO. LTD.)

(耀鑽科技股份有限公司 / YOSONIC TECHNOLOGY CO., LTD.)

桃園縣楊梅市幼獅工業區幼四路1號 / NO. 1, YOU 4TH ROAD, YOUTH INDUSTRIAL DISTRICT, YANG-MEI CITY, TAO-YUAN HSIEN. TAIWAN R. O. C.

(廣東省東莞市黃江鎮黃牛埔福祥街2號 / NO. 2, FUXIANG STREET, HUANGNIUPU, HUANGJIANG TOWN, DONGGUAN, GUANGDONG)

(江蘇省昆山市蓬朗昆嘉高科技工業區郭澤路 / GUO-ZE ROAD, KUNJIA HI-TECH INDUSTRIAL PARK, KUN-SHAN, JIANG-SU, CHINA)

(桃園縣中壢市中壢工業區長春六路15號 / NO. 15, CHANGCHUN 6TH RD., JHONGLI CITY, TAOYUAN COUNTY 320, TAIWAN (R. O. C.))

六溴環十二烷分析流程圖 / HBCDD analytical flow chart

- 測試人員：翁賜彬 / Name of the person who made measurement: Roman Wong
- 測試負責人：張啓興 / Name of the person in charge of measurement: Troy Chang

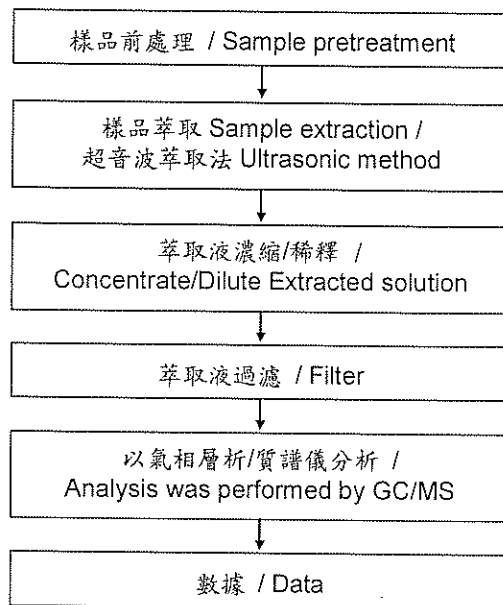

This document is issued by the Company subject to its General Conditions of Service printed overleaf, available on request or accessible at <http://www.sgs.com.tw/Forms-and-Conditions.aspx> and, for electronic format documents, subject to Terms and Conditions for Electronic Documents at <http://www.sgs.com.tw/terms-and-conditions/taizhong/Document.aspx>. Attention is drawn to the limitation of liability, indemnification and jurisdiction issues defined therein. Any holder of this document is advised that information contained hereon reflects the Company's findings at the time of its intervention only and within the limits of client's instruction, if any. The Company's sole responsibility is to its Client and this document does not exonerate parties to a transaction from exercising all their rights and obligations under the transaction documents. This document cannot be reproduced, except in full, without prior written approval of the Company. Any unauthorized alteration, forgery or falsification of the content or appearance of this document is unlawful and offenders may be prosecuted to the fullest extent of the law. Unless otherwise stated the results shown in this test report refer only to the sample(s) tested.



測試報告

Test Report

號碼(No.) : CE/2014/14393 日期(Date) : 2014/01/24 頁數(Page) : 10 of 13

西北臺慶科技股份有限公司 / TAI-TECH ADVANCED ELECTRONICS CO., LTD.

(東莞臺慶精密電子有限公司 / TAI-TECH ADVANCED ELECTRONICS (DONGGUAN) CO. LTD.)

(臺慶精密電子(昆山)有限公司 / TAI-TECH ADVANCED ELECTRONICS (KUN-SHAN) CO. LTD.)

(耀鑽科技股份有限公司 / YOSONIC TECHNOLOGY CO., LTD.)

桃園縣楊梅市幼獅工業區幼四路1號 / NO. 1, YOU 4TH ROAD, YOUTH INDUSTRIAL DISTRICT, YANG-MEI CITY, TAO-YUAN HSIEN. TAIWAN R. O. C.

(廣東省東莞市黃江鎮黃牛埔福祥街2號 / NO. 2, FUXIANG STREET, HUANGNIUPU, HUANGJIANG TOWN, DONGGUAN, GUANGDONG)

(江蘇省昆山市蓬朗昆嘉高科技工業區郭澤路 / GUO-ZE ROAD, KUNJIA HI-TECH INDUSTRIAL PARK, KUN-SHAN, JIANG-SU, CHINA)

(桃園縣中壢市中壢工業區長春六路15號 / NO. 15, CHANGCHUN 6TH RD., JHONGLI CITY, TAOYUAN COUNTY 320, TAIWAN (R. O. C.))

可塑劑分析流程圖 / Analytical flow chart of phthalate content

- 測試人員：翁賜彬 / Name of the person who made measurement: Roman Wong
- 測試負責人：張啓興 / Name of the person in charge of measurement: Troy Chang

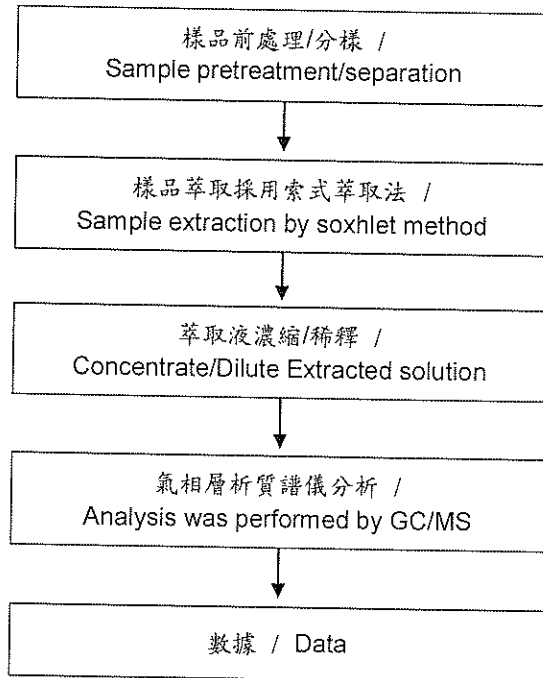

This document is issued by the Company subject to its General Conditions of Service printed overleaf, available on request or accessible at <http://www.sgs.com.tw/Terms-and-Conditions.asp> and, for electronic format documents, subject to Terms and Conditions for Electronic Documents at <http://www.sgs.com.tw/electronic/Terms-and-Conditions-for-Electronic-Document.asp>. Attention is drawn to the limitation of liability, indemnification and jurisdiction issues defined therein. Any holder of this document is advised that information contained hereon reflects the Company's findings at the time of its intervention only and within the limits of client's instruction, if any. The Company's sole responsibility is to its Client and this document does not exonerate parties to a transaction from exercising all their rights and obligations under the transaction documents. This document cannot be reproduced, except in full, without prior written approval of the Company. Any unauthorized alteration, forgery or falsification of the content or appearance of this document is unlawful and offenders may be prosecuted to the fullest extent of the law. Unless otherwise stated the results shown in this test report refer only to the sample(s) tested.



測試報告

Test Report

號碼(No.) : CE/2014/14393 日期(Date) : 2014/01/24 頁數(Page) : 11 of 13

西北臺慶科技股份有限公司 / TAI-TECH ADVANCED ELECTRONICS CO., LTD.

(東莞臺慶精密電子有限公司 / TAI-TECH ADVANCED ELECTRONICS (DONGGUAN) CO. LTD.)

(臺慶精密電子(昆山)有限公司 / TAI-TECH ADVANCED ELECTRONICS (KUN-SHAN) CO. LTD.)

(耀鑽科技股份有限公司 / YOSONIC TECHNOLOGY CO., LTD.)

桃園縣楊梅市幼獅工業區幼四路1號 / NO. 1, YOU 4TH ROAD, YOUTH INDUSTRIAL DISTRICT, YANG-MEI CITY, TAO-YUAN HSIEN, TAIWAN R. O. C.

(廣東省東莞市黃江鎮黃牛埔福祥街2號 / NO. 2, FUXIANG STREET, HUANGNIUPU, HUANGJIANG TOWN, DONGGUAN, GUANGDONG)

(江蘇省昆山市蓬朗昆嘉高科技工業區郭澤路 / GUO-ZE ROAD, KUNJIA HI-TECH INDUSTRIAL PARK, KUN-SHAN, JIANG-SU, CHINA)

(桃園縣中壢市中壢工業區長春六路15號 / NO. 15, CHANGCHUN 6TH RD., JHONGLI CITY, TAOYUAN COUNTY 320, TAIWAN (R. O. C.))



鹵素分析流程圖 / Analytical flow chart of halogen content

- 測試人員：陳恩臻 / Name of the person who made measurement: Rita Chen
- 測試負責人：張啓興 / Name of the person in charge of measurement: Troy Chang

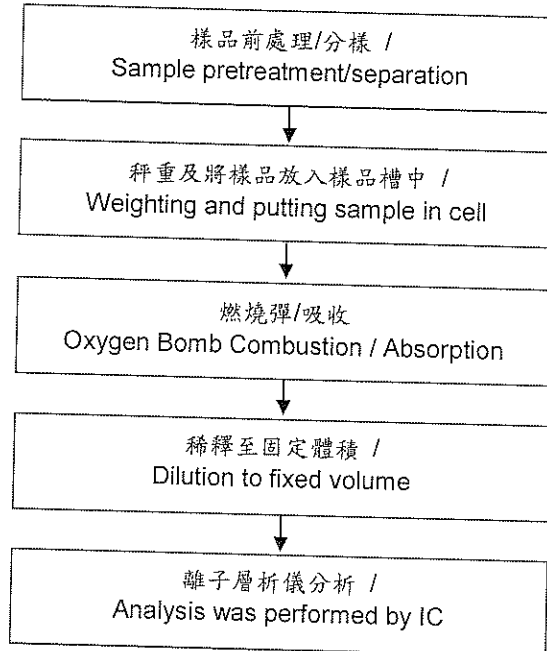

This document is issued by the Company subject to its General Conditions of Service printed overleaf, available on request or accessible at <http://www.sgs.com.tw/Terms-and-Conditions.aspx> and, for electronic format documents, subject to Terms and Conditions for Electronic Documents at <http://www.sgs.com.tw/terms-and-conditions/term36-Documenal.aspx>. Attention is drawn to the limitation of liability, indemnification and jurisdiction issues defined therein. Any holder of this document is advised that information contained hereon reflects the Company's findings at the time of its intervention only and within the limits of client's instruction, if any. The Company's sole responsibility is to its Client and this document does not exonerate parties to a transaction from exercising all their rights and obligations under the transaction documents. This document cannot be reproduced, except in full, without prior written approval of the Company. Any unauthorized alteration, forgery or falsification of the content or appearance of this document is unlawful and offenders may be prosecuted to the fullest extent of the law. Unless otherwise stated the results shown in this test report refer only to the sample(s) tested.



測試報告

Test Report

號碼(No.) : CE/2014/14393 日期(Date) : 2014/01/24 頁數(Page) : 12 of 13



西北臺慶科技股份有限公司 / TAI-TECH ADVANCED ELECTRONICS CO., LTD.
 (東莞臺慶精密電子有限公司 / TAI-TECH ADVANCED ELECTRONICS (DONGGUAN) CO. LTD.)
 (臺慶精密電子(昆山)有限公司 / TAI-TECH ADVANCED ELECTRONICS (KUN-SHAN) CO. LTD.)
 (耀鑽科技股份有限公司 / YOSONIC TECHNOLOGY CO., LTD.)
 桃園縣楊梅市幼獅工業區幼四路1號 / NO. 1, YOU 4TH ROAD, YOUTH INDUSTRIAL DISTRICT, YANG-MEI CITY, TAO-YUAN HSIEN, TAIWAN R. O. C.
 (廣東省東莞市黃江鎮黃牛埔福祥街2號 / NO. 2, FUXIANG STREET, HUANGNIUPU, HUANGJIANG TOWN, DONGGUAN, GUANGDONG)
 (江蘇省昆山市蓬朗昆嘉高科技工業區郭澤路 / GUO-ZE ROAD, KUNJIA HI-TECH INDUSTRIAL PARK, KUN-SHAN, JIANG-SU, CHINA)
 (桃園縣中壢市中壢工業區長春六路15號 / NO. 15, CHANGCHUN 6TH RD., JHONGLI CITY, TAOYUAN COUNTY 320, TAIWAN (R. O. C.))

- 1) 根據以下的流程圖之條件，樣品已完全溶解。 / These samples were dissolved totally by pre-conditioning method according to below flow chart.
- 2) 測試人員：楊登偉 / Name of the person who made measurement: Climbgreat Yang
- 3) 測試負責人：張啓興 / Name of the person in charge of measurement: Troy Chang

元素以 ICP-AES 分析的消化流程圖

(Flow Chart of digestion for the elements analysis performed by ICP-AES)

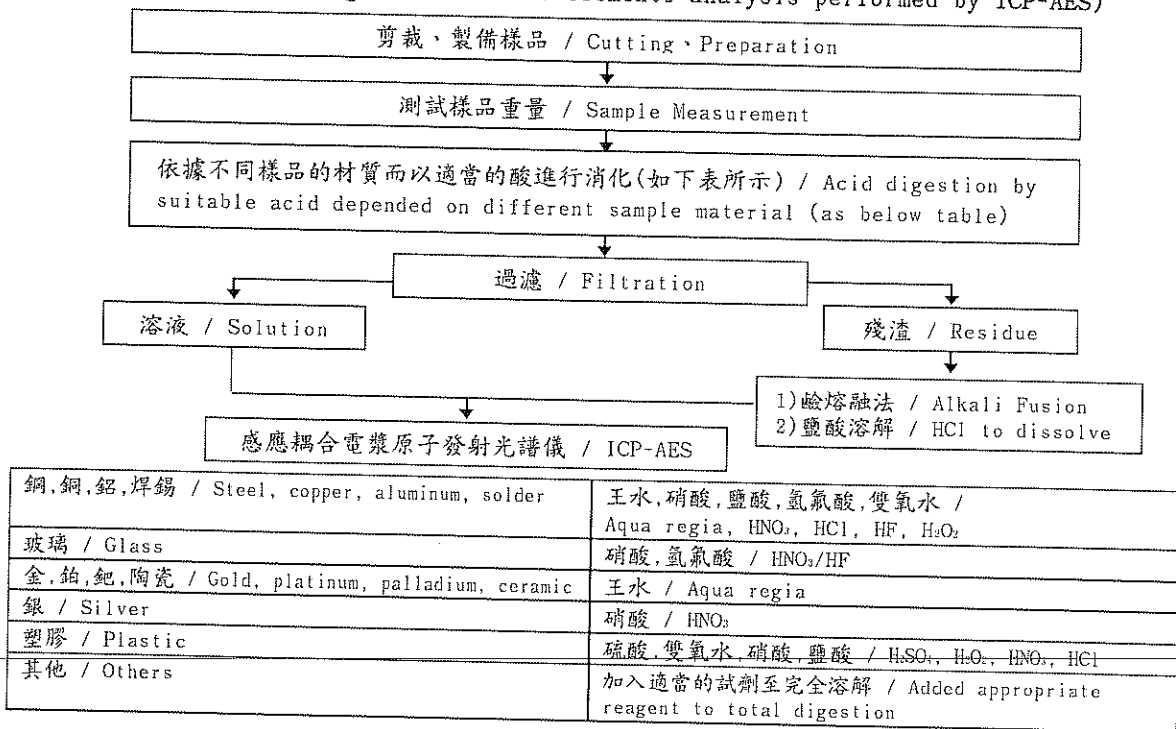

This document is issued by the Company subject to its General Conditions of Service printed overleaf, available on request or accessible at <http://www.sgs.com.tw/en/terms-and-conditions.aspx> and, for electronic format documents, subject to Terms and Conditions for Electronic Documents at <http://www.sgs.com.tw/en/terms-and-conditions/Termse-Documents.aspx>. Attention is drawn to the limitation of liability, indemnification and jurisdiction issues defined therein. Any holder of this document is advised that information contained hereon reflects the Company's findings at the time of its intervention only and within the limits of client's instruction, if any. The Company's sole responsibility is to its Client and this document does not exonerate parties to a transaction from exercising all their rights and obligations under the transaction documents. This document cannot be reproduced, except in full, without prior written approval of the Company. Any unauthorized alteration, forgery or falsification of the content or appearance of this document is unlawful and offenders may be prosecuted to the fullest extent of the law. Unless otherwise stated the results shown in this test report refer only to the sample(s) tested.

測試報告 Test Report

號碼(No.) : CE/2014/14393 日期(Date) : 2014/01/24 頁數(Page) : 13 of 13

西北臺慶科技股份有限公司 / TAI-TECH ADVANCED ELECTRONICS CO., LTD.



(東莞臺慶精密電子有限公司 / TAI-TECH ADVANCED ELECTRONICS (DONGGUAN) CO. LTD.)

(臺慶精密電子(昆山)有限公司 / TAI-TECH ADVANCED ELECTRONICS (KUN-SHAN) CO. LTD.)

(耀鑽科技股份有限公司 / YOSONIC TECHNOLOGY CO., LTD.)

桃園縣楊梅市幼獅工業區幼四路1號 / NO. 1, YOU 4TH ROAD, YOUTH INDUSTRIAL DISTRICT, YANG-MEI CITY, TAO-YUAN HSIEN. TAIWAN R. O. C.

(廣東省東莞市黃江鎮黃牛埔福祥街2號 / NO. 2, FUXIANG STREET, HUANGNIUPU, HUANGJIANG TOWN, DONGGUAN, GUANGDONG)

(江蘇省昆山市蓬朗昆嘉高科技工業區郭澤路 / GUO-ZE ROAD, KUNJIA HI-TECH INDUSTRIAL PARK, KUN-SHAN, JIANG-SU, CHINA)

(桃園縣中壢市中壢工業區長春六路15號 / NO. 15, CHANGCHUN 6TH RD., JHONGLI CITY, TAOYUAN COUNTY 320, TAIWAN (R. O. C.))

* 照片中如有箭頭標示，則表示為實際檢測之樣品/部位。*

(The tested sample / part is marked by an arrow if it's shown on the photo.)

CE/2014/14393

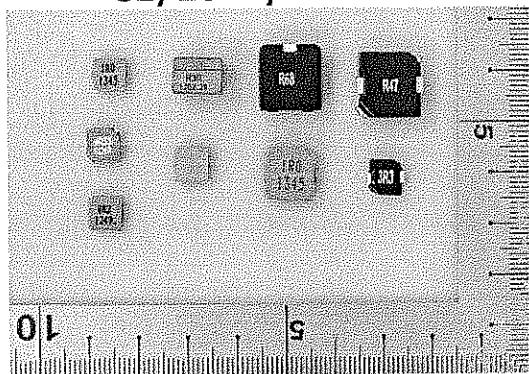

CE/2014/14393

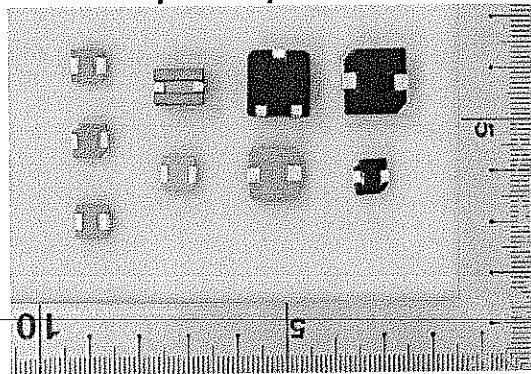

** 報告結尾 (End of Report) **

This document is issued by the Company subject to its General Conditions of Service printed overleaf, available on request or accessible at <http://www.sgs.com/en/terms-and-conditions.aspx> and, for electronic format documents, subject to Terms and Conditions for Electronic Documents at <http://www.sgs.com/en/terms-and-conditions/terms-and-conditions-for-electronic-documents.aspx>. Attention is drawn to the limitation of liability, indemnification and jurisdiction issues defined therein. Any holder of this document is advised that information contained hereon reflects the Company's findings at the time of its intervention only and within the limits of client's instruction, if any. The Company's sole responsibility is to its Client and this document does not exonerate parties to a transaction from exercising all their rights and obligations under the transaction documents. This document cannot be reproduced, except in full, without prior written approval of the Company. Any unauthorized alteration, forgery or falsification of the content or appearance of this document is unlawful and offenders may be prosecuted to the fullest extent of the law. Unless otherwise stated the results shown in this test report refer only to the sample(s) tested.