

## Features

- P-Channel
- Enhancement mode
- Fast Switching
- Pb-free lead plating; RoHS compliant

$V_{DS}$	-30	V
$R_{DS(on),max} @ V_{GS}=-10V$	52	m $\Omega$
$R_{DS(on),max} @ V_{GS}=-4.5V$	62	m $\Omega$
$I_D$	-3.4	A



### SOT23

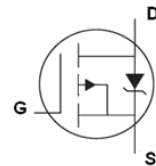
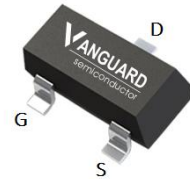

Part ID	Package Type	Marking	Tape and reel information
VS3540AC	SOT23	VS01	3000pcs/reel

### Maximum ratings, at $T_j = 25^\circ\text{C}$ , unless otherwise specified

Symbol	Parameter	Rating	Unit
$V_{(BR)DSS}$	Drain-Source breakdown voltage	-30	V
$V_{GS}$	Gate-Source voltage	$\pm 12$	V
$I_S$	Diode continuous forward current	$T_A = 25^\circ\text{C}$ -1.2	A
$I_D$	Continuous drain current @ $V_{GS} = -4.5\text{V}$	$T_A = 25^\circ\text{C}$ -3.4	A
		$T_A = 70^\circ\text{C}$ -2.7	A
$I_{DM}$	Pulse drain current tested ①	$T_A = 25^\circ\text{C}$ 12	A
$P_D$	Maximum power dissipation	$T_A = 25^\circ\text{C}$ 1	W
$T_{STG} T_J$	Storage and operating temperature range	-55 to 150	$^\circ\text{C}$
<b>Thermal Characteristics</b>			
$R_{\theta JL}$	Thermal Resistance, Junction-to-Lead	80	$^\circ\text{C/W}$
$R_{\theta JA}$	Thermal Resistance, Junction-to-Ambient	125	$^\circ\text{C/W}$

**Electrical Characteristics**

Symbol	Parameter	Condition	Min.	Typ.	Max.	Unit
<b>Static Electrical Characteristics @ T<sub>j</sub> = 25°C (unless otherwise stated)</b>						
V <sub>(BR)DSS</sub>	Drain-Source Breakdown Voltage	V <sub>GS</sub> =0V, I <sub>D</sub> =-250μA	-30	--	--	V
I <sub>DSS</sub>	Zero Gate Voltage Drain Current(T <sub>j</sub> =25°C)	V <sub>DS</sub> =-30V, V <sub>GS</sub> =0V	--	--	1	μA
	Zero Gate Voltage Drain Current(T <sub>j</sub> =125°C)	V <sub>DS</sub> =-30V, V <sub>GS</sub> =0V	--	--	100	μA
I <sub>GSS</sub>	Gate-Body Leakage Current	V <sub>GS</sub> =±12V, V <sub>DS</sub> =0V	--	--	±100	nA
V <sub>GS(TH)</sub>	Gate Threshold Voltage	V <sub>DS</sub> =V <sub>GS</sub> , I <sub>D</sub> =-250μA	-0.5	--	-1.2	V
R <sub>DS(ON)</sub>	Drain-Source On-State Resistance②	V <sub>GS</sub> =-10V, I <sub>D</sub> =-4A	--	52	60	mΩ
		V <sub>GS</sub> =-4.5V, I <sub>D</sub> =-3A	--	62	70	mΩ
		V <sub>GS</sub> =-2.5V, I <sub>D</sub> =-2A	--	81	105	mΩ
<b>Dynamic Electrical Characteristics @ T<sub>j</sub> = 25°C (unless otherwise stated)</b>						
C <sub>iss</sub>	Input Capacitance	V <sub>DS</sub> =-15V, V <sub>GS</sub> =0V, f=1MHz	--	805	--	pF
C <sub>oss</sub>	Output Capacitance		--	60	--	pF
C <sub>rss</sub>	Reverse Transfer Capacitance		--	50	--	pF
R <sub>g</sub>	Gate Resistance	f=1MHz	--	10	--	Ω
Q <sub>g</sub>	Total Gate Charge	V <sub>DS</sub> =-15V, I <sub>D</sub> =-4A, V <sub>GS</sub> =-4.5V	--	10	--	nC
Q <sub>gs</sub>	Gate-Source Charge		--	2.3	--	nC
Q <sub>gd</sub>	Gate-Drain Charge		--	4.2	--	nC
<b>Switching Characteristics</b>						
t <sub>d(on)</sub>	Turn-on Delay Time	V <sub>DD</sub> =-15 V, I <sub>D</sub> =-4A, R <sub>G</sub> =3Ω, V <sub>GS</sub> =-4.5V	--	4	--	ns
t <sub>r</sub>	Turn-on Rise Time		--	4	--	ns
t <sub>d(off)</sub>	Turn-Off Delay Time		--	28	--	ns
t <sub>f</sub>	Turn-Off Fall Time		--	4.6	--	ns
<b>Source- Drain Diode Characteristics @ T<sub>j</sub> = 25°C (unless otherwise stated)</b>						
V <sub>SD</sub>	Forward on voltage	I <sub>SD</sub> =-3A, V <sub>GS</sub> =0V	--	-0.85	-1.2	V
t <sub>rr</sub>	Reverse Recovery Time	T <sub>j</sub> =25°C, I <sub>sd</sub> =-3A, V <sub>GS</sub> =0V di/dt=-100A/μs	--	12	--	ns
Q <sub>rr</sub>	Reverse Recovery Charge		--	3.6	--	nC

**NOTE:**

- ① Repetitive rating; pulse width limited by max junction temperature.  
 ② Pulse width ≤ 300μs; duty cycle ≤ 2%.

Typical Characteristics

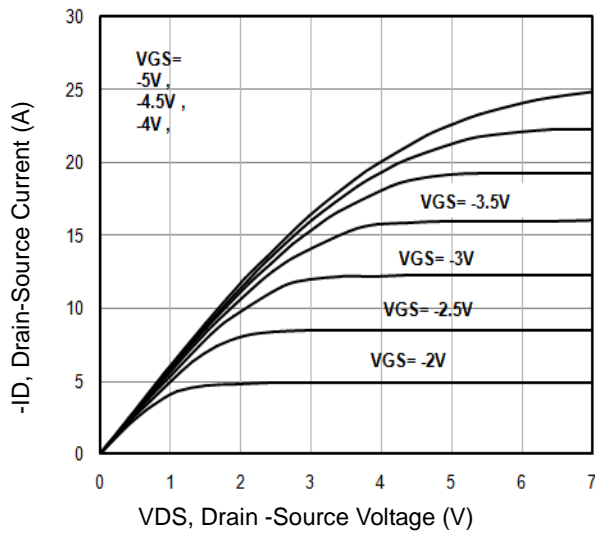

Fig1. Typical Output Characteristics

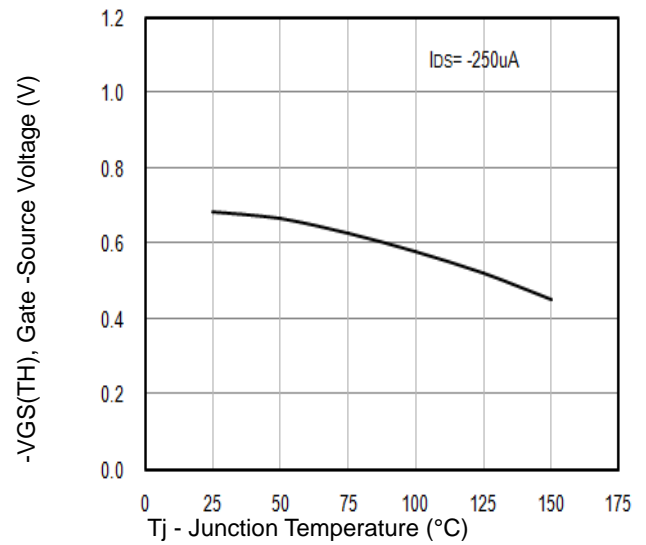

Fig2.  $V_{GS(TH)}$  Gate-Source Voltage Vs.  $T_j$

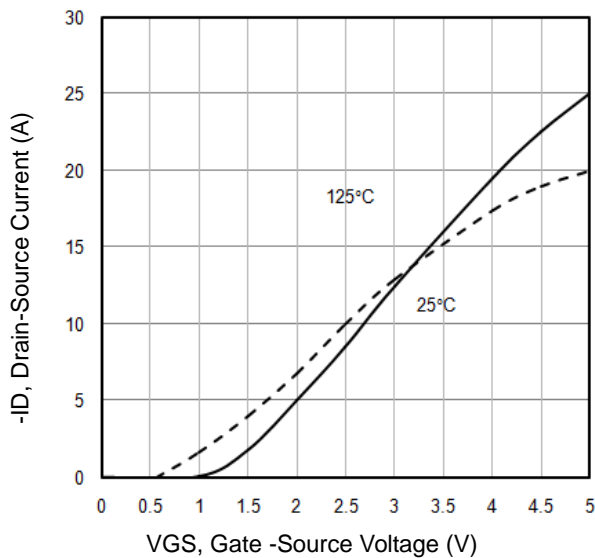

Fig3. Typical Transfer Characteristics

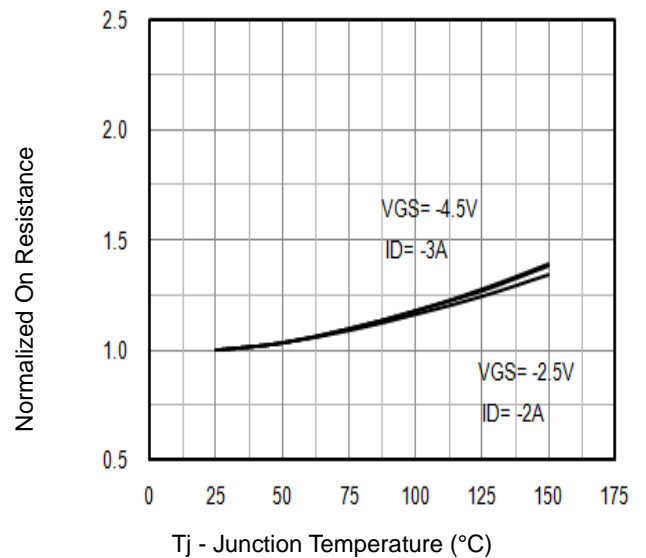

Fig4. Normalized On-Resistance Vs.  $T_j$

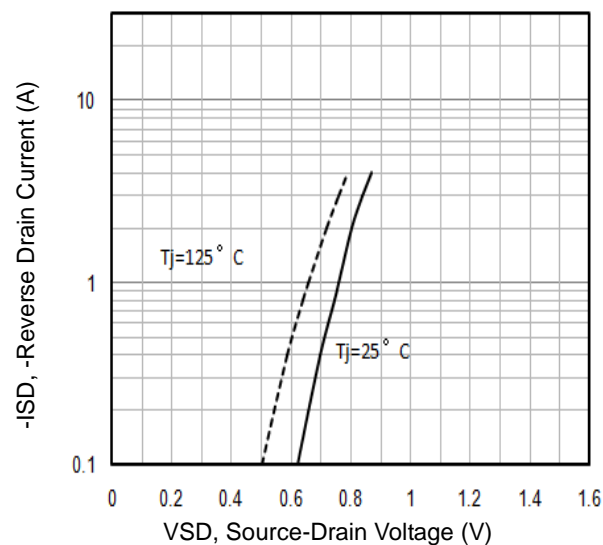

Fig5. Typical Source-Drain Diode Forward Voltage

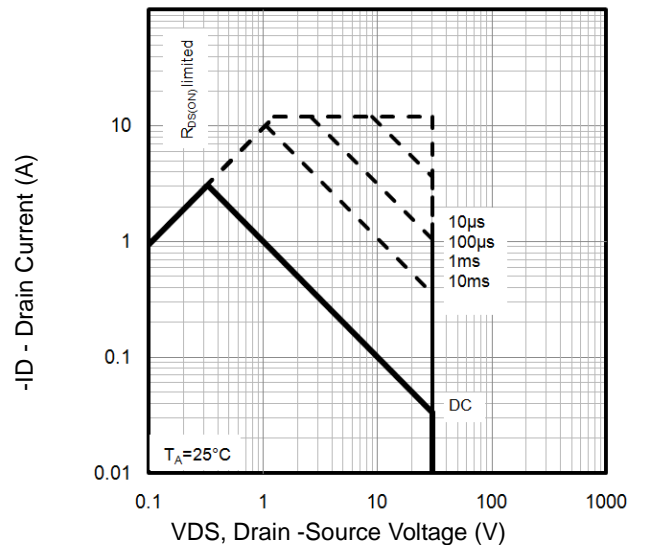

Fig6. Maximum Safe Operating Area

Typical Characteristics

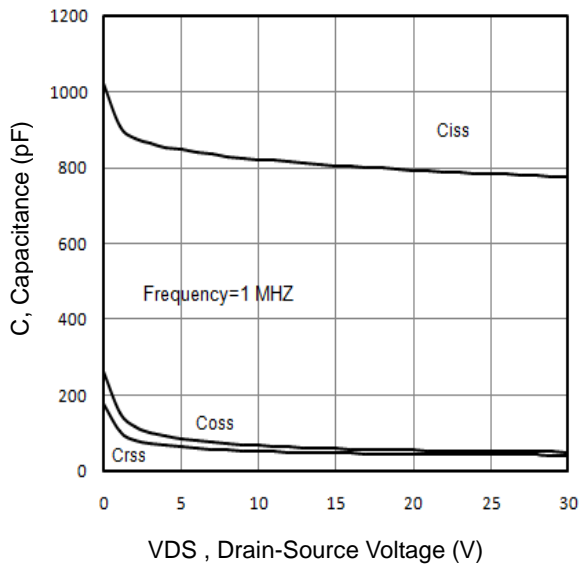

Fig7. Typical Capacitance Vs.Drain-Source Voltage

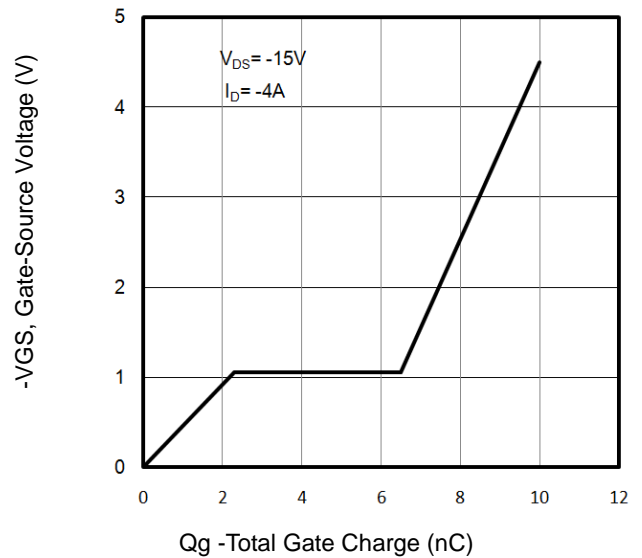

Fig8. Typical Gate Charge Vs.Gate-Source Voltage

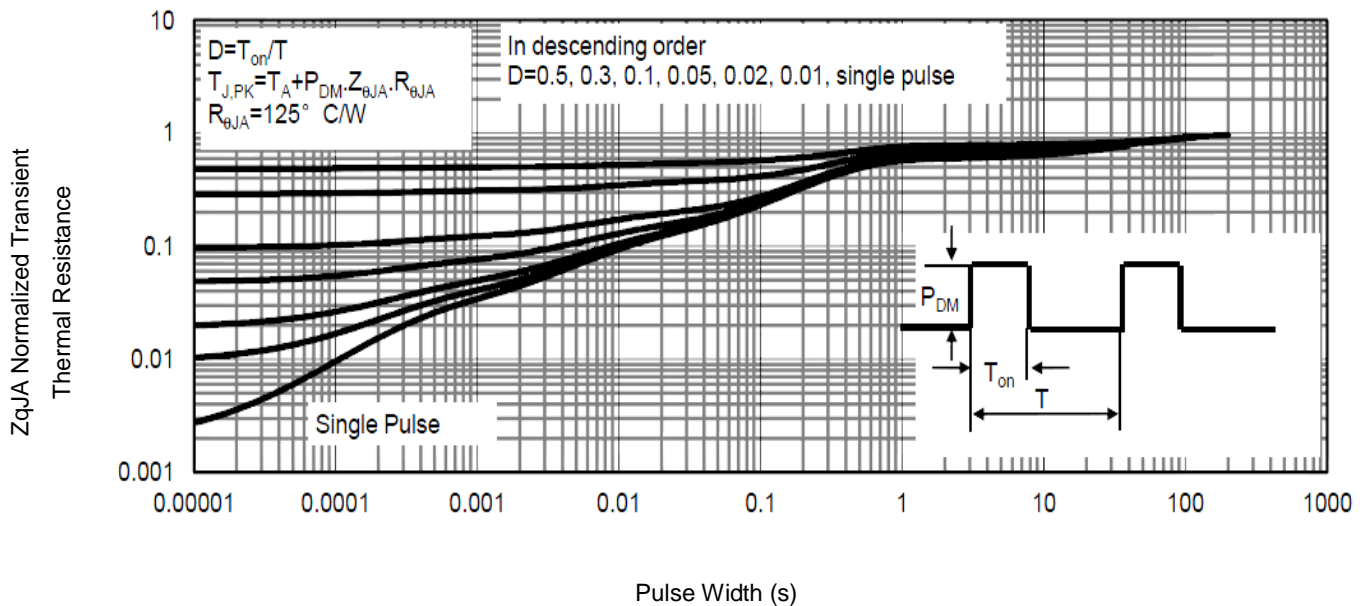

Fig9. Normalized Maximum Transient Thermal Impedance

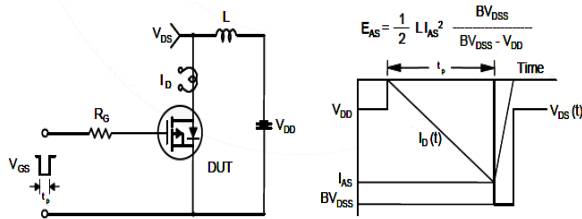

Fig10. Unclamped Inductive Test Circuit and waveforms

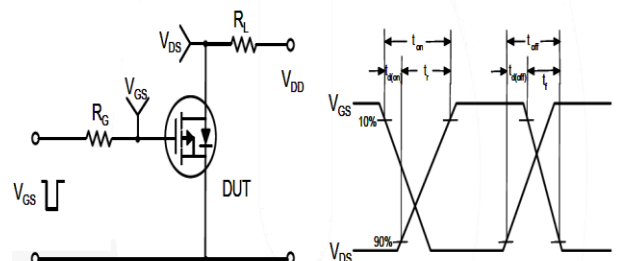
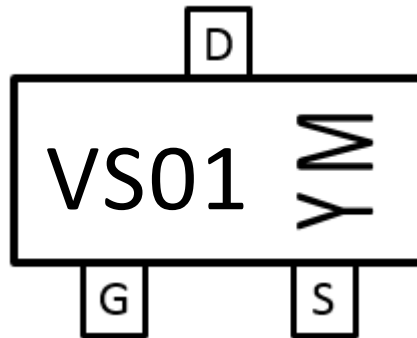

Fig11. Switching Time Test Circuit and waveforms

**Marking Information**



VS01: Part Number

YM: Date Code, Y means assembly year (e.g. E=2017, F=2018, G=2019, H=2020, etc),

M means assembly month (e.g. 9=September, O=October, N=November, D=December, etc)

SOT23 Package Outline Data

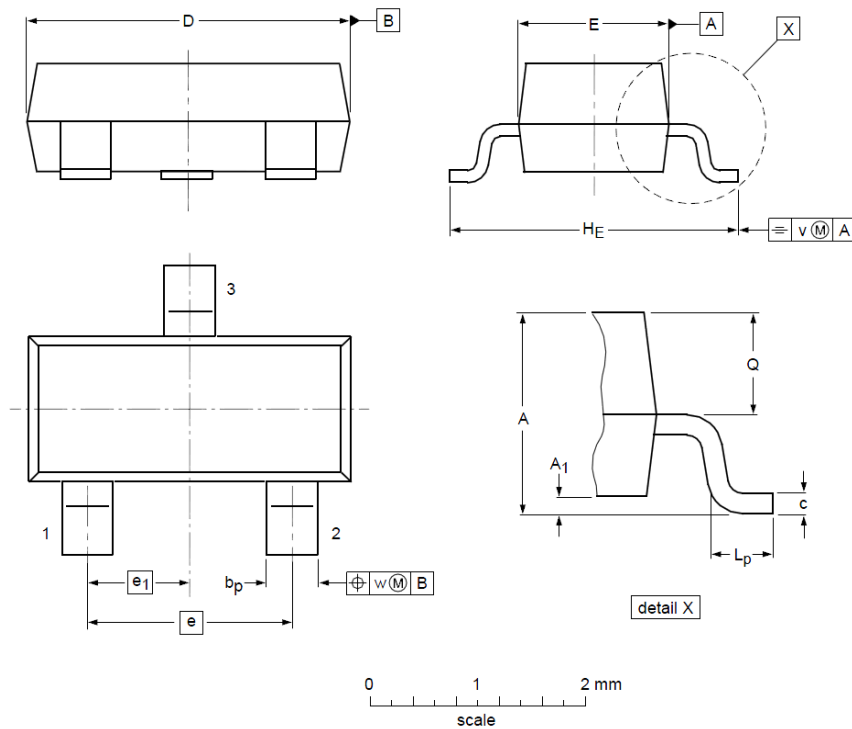

Label	DIMENSIONS ( unit: mm )		
	Min	Typ	Max
A	0.90	1.03	1.10
A <sub>1</sub>	0.01	0.05	0.10
b <sub>p</sub>	0.38	0.42	0.48
c	0.09	0.13	0.15
D	2.80	2.92	3.00
E	1.20	1.33	1.40
e	--	1.90	--
e <sub>1</sub>	--	0.95	--
H <sub>E</sub>	2.10	2.40	2.50
L <sub>p</sub>	0.40	0.50	0.60
Q	0.45	0.49	0.55
v	--	0.20	--
w	--	0.10	--

Notes:

1. Follow JEDEC TO-236, variation AB.
2. Dimension "D" does NOT include mold flash, protrusions or gate burrs. Mold flash, protrusions or gate burrs shall not exceed 0.25mm per side.
3. Dimension "E" does NOT include interlead flash or protrusion. Interlead flash or protrusion shall not exceed 0.25mm per side.

Customer Service

Sales and Service:

[sales@vgsemi.com](mailto:sales@vgsemi.com)

Vanguard Semiconductor CO., LTD

TEL: (86-755) -26902410

FAX: (86-755) -26907027

WEB: [www.vgsemi.com](http://www.vgsemi.com)