

Features

- Enhancement mode
- Low on-resistance $R_{DS(on)}$ @ $V_{GS}=2.5\text{ V}$
- Fast Switching and High efficiency
- Pb-free lead plating; RoHS compliant

V_{DS}	16	V
$R_{DS(on),TYP}$ @ $V_{GS}=4.5\text{ V}$	28	m Ω
$R_{DS(on),TYP}$ @ $V_{GS}=2.5\text{ V}$	37	m Ω
I_D	5.5	A



Part ID	Package Type	Marking	Tape and reel information
VS8205BH	SOT23-6L	VS17	3000pcs/reel

SOT23-6L

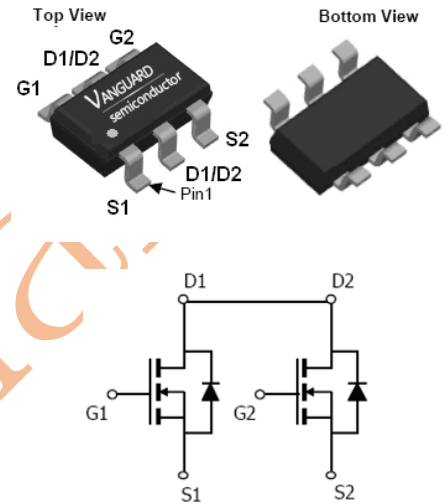

Maximum ratings, at $T_A=25\text{ }^\circ\text{C}$, unless otherwise specified

Symbol	Parameter	Rating	Unit	
$V_{(BR)DSS}$	Drain-Source breakdown voltage	16	V	
V_{GS}	Gate-Source voltage	± 10	V	
I_S	Diode continuous forward current	$T_A=25\text{ }^\circ\text{C}$	1	A
I_D	Continuous drain current @ $V_{GS}=4.5\text{ V}$	$T_A=25\text{ }^\circ\text{C}$	5.5	A
		$T_A=100\text{ }^\circ\text{C}$	3.5	A
I_{DM}	Pulse drain current tested ①	$T_A=25\text{ }^\circ\text{C}$	30	A
P_D	Maximum power dissipation	$T_A=25\text{ }^\circ\text{C}$	1.25	W
T_{STG}, T_J	Storage and operating temperature range	-55 to 150	$^\circ\text{C}$	

Thermal Characteristics

Symbol	Parameter	Typical	Unit
$R_{\theta JL}$	Thermal Resistance, Junction to Lead	60	$^\circ\text{C/W}$
$R_{\theta JA}$	Thermal Resistance, Junction to Ambient	100	$^\circ\text{C/W}$

Electrical Characteristics

Symbol	Parameter	Condition	Min.	Typ.	Max.	Unit
Static Electrical Characteristics @ T_J = 25°C (unless otherwise stated)						
V _{(BR)DSS}	Drain-Source Breakdown Voltage	V _{GS} =0V, I _D =250μA	16	--	--	V
I _{DSS}	Zero Gate Voltage Drain Current(T _J =25°C)	V _{DS} =16V, V _{GS} =0V	--	--	1	μA
	Zero Gate Voltage Drain Current(T _J =125°C)	V _{DS} =16V, V _{GS} =0V	--	--	100	μA
I _{GSS}	Gate-Body Leakage Current	V _{GS} =±10V, V _{DS} =0V	--	--	±100	nA
V _{GS(TH)}	Gate Threshold Voltage	V _{DS} =V _{GS} , I _D =250μA	0.3	--	0.9	V
R _{DS(ON)}	Drain-Source On-State Resistance ②	V _{GS} =10V, I _D =4A	--	25	41	mΩ
R _{DS(ON)}	Drain-Source On-State Resistance ②	V _{GS} =4.5V, I _D =3A	--	28	46	mΩ
R _{DS(ON)}	Drain-Source On-State Resistance ②	V _{GS} =2.5V, I _D =1A	--	37	56	mΩ
R _{DS(ON)}	Drain-Source On-State Resistance ②	V _{GS} =1.8V, I _D =1A	--	55	79	mΩ
Dynamic Electrical Characteristics @ T_J = 25°C (unless otherwise stated)						
C _{iss}	Input Capacitance	V _{DS} =8V, V _{GS} =0V, f=1MHz	580	685	790	pF
C _{oss}	Output Capacitance		70	80	90	pF
C _{rss}	Reverse Transfer Capacitance		65	75	85	pF
R _g	Gate Resistance	f=1MHz	--	6.5	--	Ω
Q _g	Total Gate Charge	V _{DS} =8V, I _D =3A, V _{GS} =4.5V	--	5.7	--	nC
Q _{gs}	Gate-Source Charge		--	0.6	--	nC
Q _{gd}	Gate-Drain Charge		--	1.8	--	nC
Switching Characteristics						
t _{d(on)}	Turn-on Delay Time	V _{DD} =8V, I _D =2.7A, R _G =3Ω, V _{GS} =10V	--	4	--	ns
t _r	Turn-on Rise Time		--	18	--	ns
t _{d(off)}	Turn-Off Delay Time		--	19	--	ns
t _f	Turn-Off Fall Time		--	8.2	--	ns
Source- Drain Diode Characteristics @ T_J = 25°C (unless otherwise stated)						
V _{SD}	Forward on voltage	I _{SD} =2A, V _{GS} =0V	--	0.8	1.2	V
t _{rr}	Reverse Recovery Time	T _J =25°C, I _{sd} =3A, V _{GS} =0V	--	12	--	ns
Q _{rr}	Reverse Recovery Charge	di/dt=100A/μs	--	2.5	--	nC

NOTE:

- ① Repetitive rating; pulse width limited by max junction temperature.
 ② Pulse width ≤ 380μs; duty cycle ≤ 2%.

Typical Characteristics

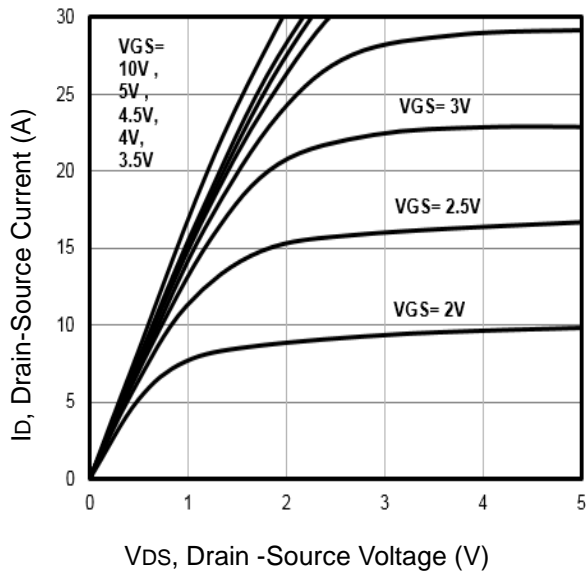

Fig1. Typical Output Characteristics

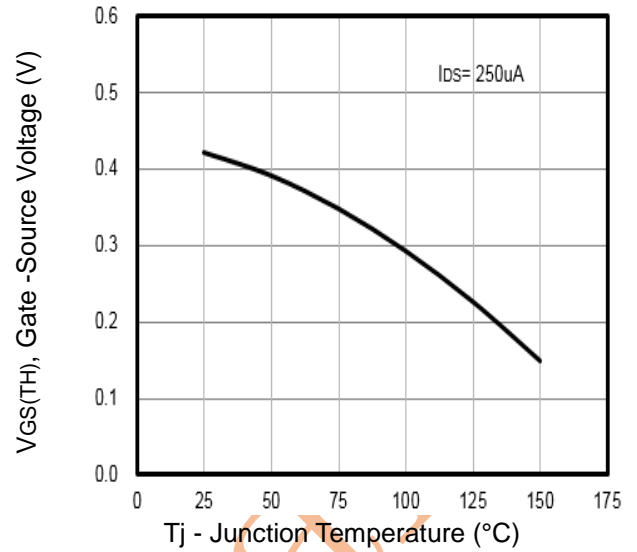

Fig2. Threshold Voltage Vs. Temperature

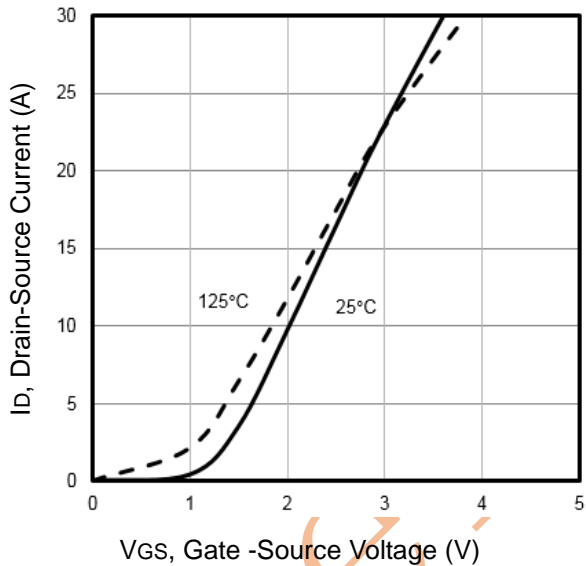

Fig3. Typical Transfer Characteristics

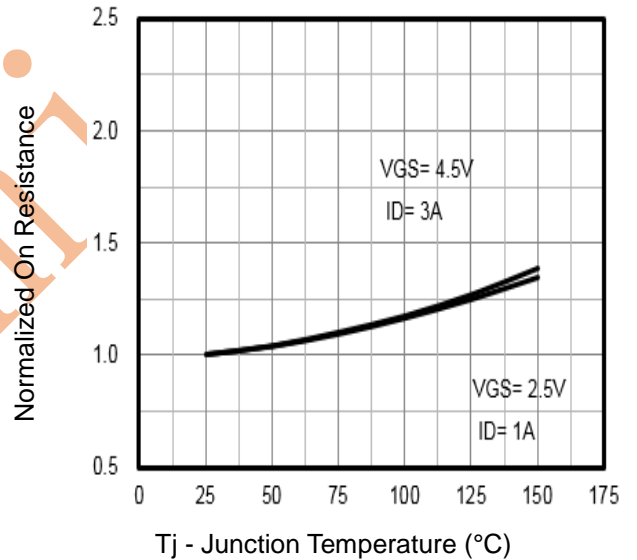

Fig4. Normalized On-Resistance Vs. Temperature

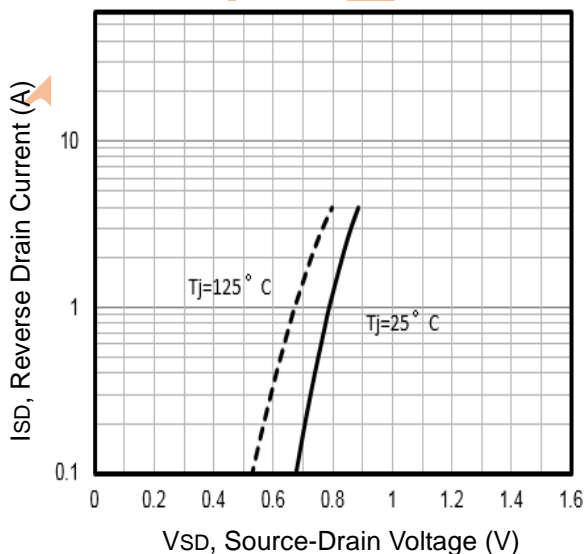

Fig5. Typical Source-Drain Diode Forward Voltage

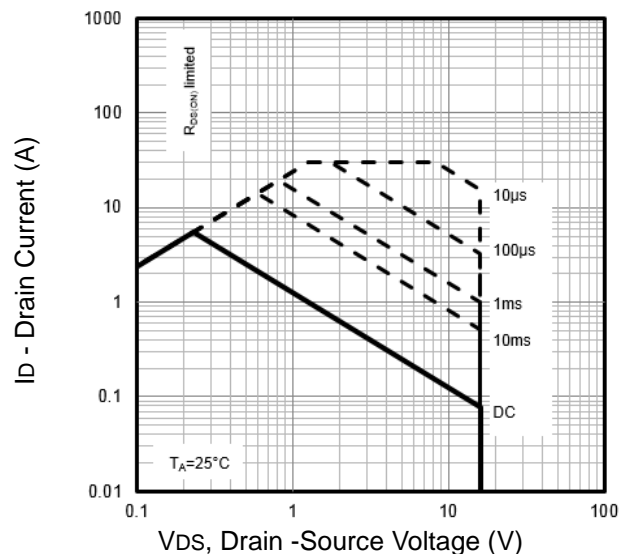

Fig6. Maximum Safe Operating Area

Typical Characteristics

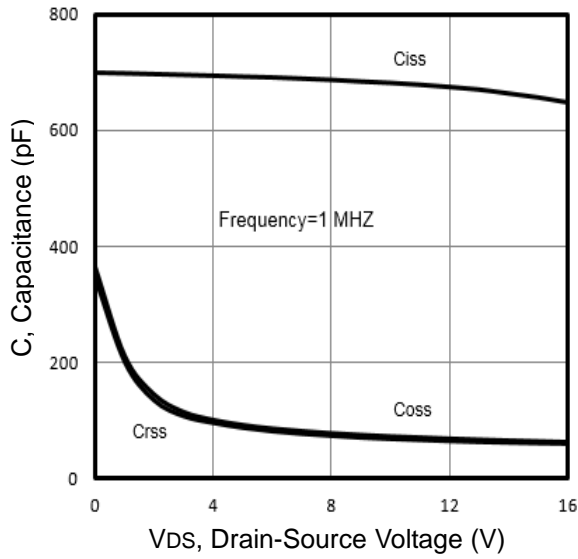

Fig7. Typical Capacitance Vs. Drain-Source Voltage

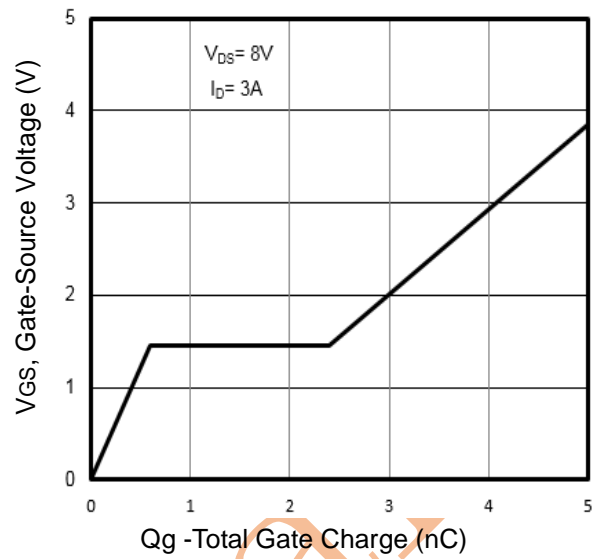

Fig8. Typical Gate Charge Vs. Gate-Source Voltage

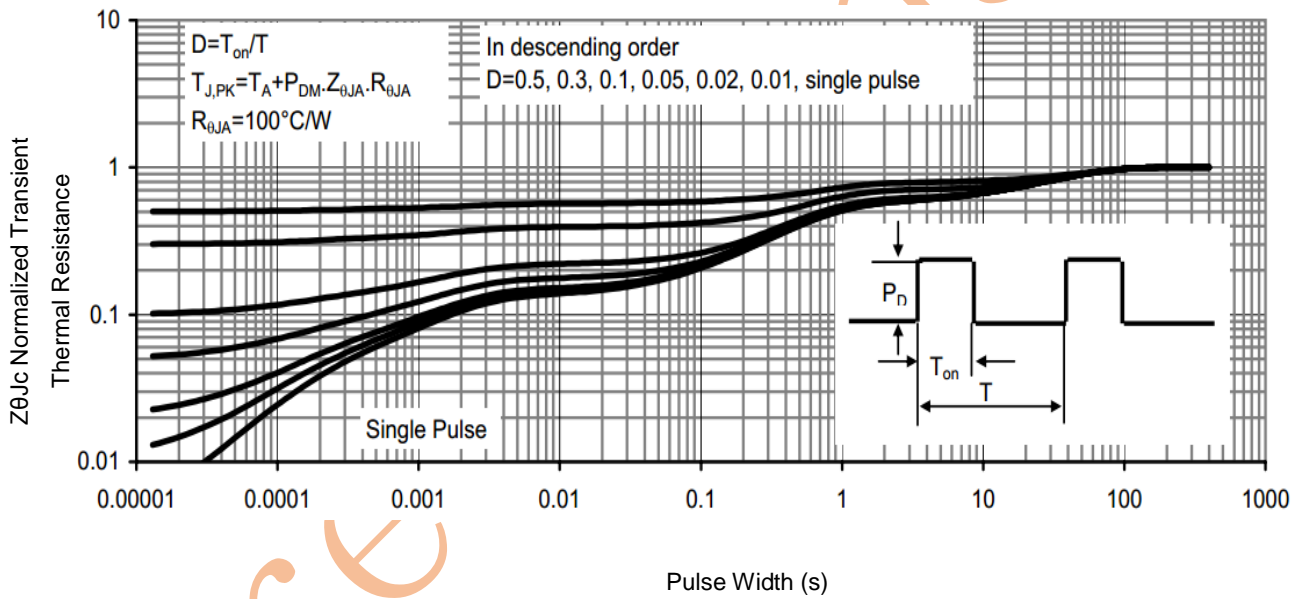

Fig9. Normalized Maximum Transient Thermal Impedance

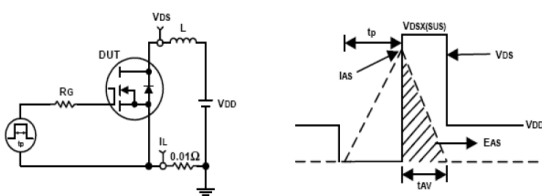

Fig10. Unclamped Inductive Test Circuit and waveforms

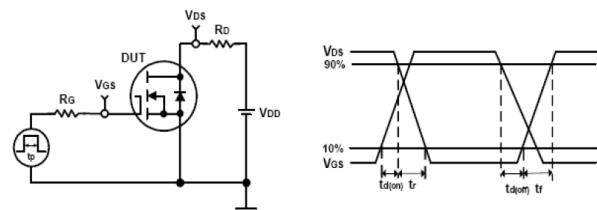
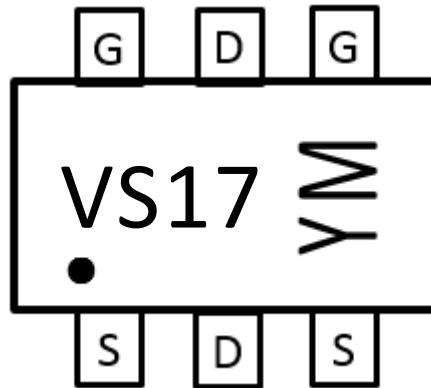

Fig11. Switching Time Test Circuit and waveforms

Marking Information



VS17: Part Number

YM: Date Code, Y means assembly year (e.g. E=2017, F=2018, G=2019, H=2020, etc),
M means assembly month (e.g. 9=September, O=October, N=November, D=December, etc)

Dot: pin1 identification

Preliminary



SOT23-6L Package Outline

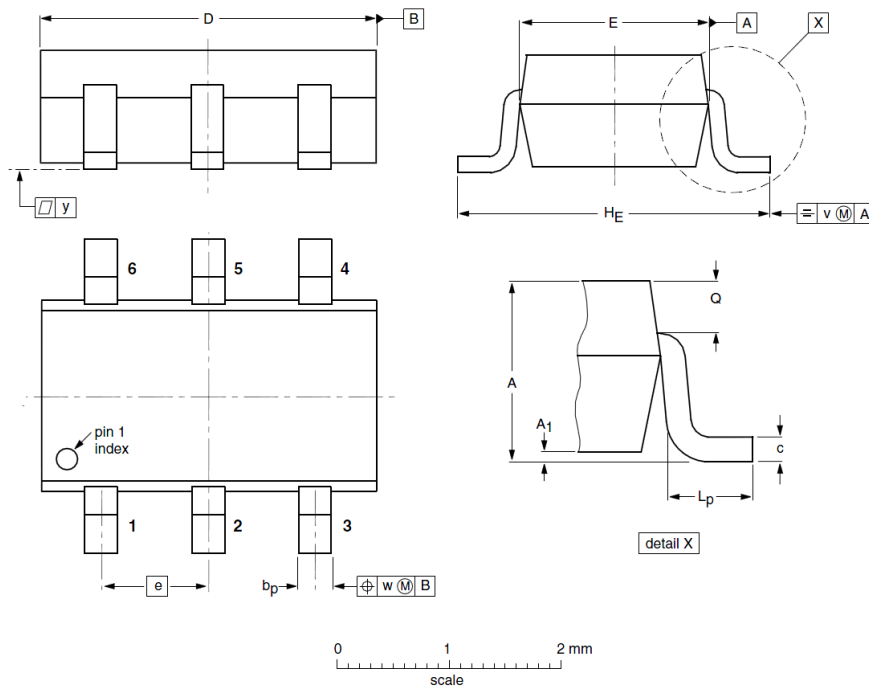

Label	Dimensions (unit: mm)		
	Min	Typ	Max
A	0.90	1.07	1.45
b_p	0.30	0.35	0.40
D	2.70	2.92	3.10
e	--	0.95	--
L_p	0.30	0.45	0.60
v	--	0.20	--
y	--	0.10	
A₁	0.01	0.05	0.15
c	0.10	0.15	0.22
E	1.30	1.55	1.70
H_E	2.50	2.80	3.00
Q	0.23	0.29	0.33
w	--	0.20	--

Notes:

1. Follow JEDEC MS-012.
2. Dimension "D" does NOT include mold flash, protrusions or gate burrs. Mold flash, protrusions or gate burrs shall not exceed 0.15mm per side.
3. Dimension "E" does NOT include interlead flash or protrusion. Interlead flash or protrusion shall not exceed 0.25mm per side.
4. Dimension "b_p" does NOT include dambar protrusion. Allowable dambar protrusion shall be 0.1mm total in excess of "b_p" dimension at maximum material condition. The dambar cannot be located on the lower radius of the foot.

Customer Service

Sales and Service:

sales@vgsemi.com

Vanguard Semiconductor CO., LTD

TEL: (86-755) -26902410

FAX: (86-755) -26907027

WEB: www.vgsemi.com