

Features

- N-Channel, 5V Logic Level Control
- Enhancement mode
- Very low on-resistance $R_{DS(on)}$ @ $V_{GS}=4.5V$
- Fast Switching
- 100% Avalanche Tested
- Pb-free lead plating; RoHS compliant



Part ID	Package Type	Marking	Tape and reel information
VST012N06MS	TO-220AB	012N06M	50pcs/Tube

V_{DS}	60	V
$R_{DS(on),TYP}@ V_{GS}=10V$	8.4	m Ω
$R_{DS(on),TYP}@ V_{GS}=4.5V$	9.8	m Ω
I_D	55	A

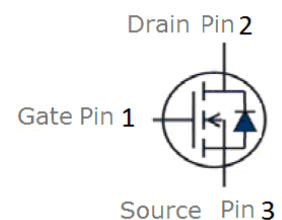
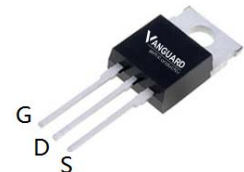
TO-220AB

Maximum ratings, at $T_j=25^\circ\text{C}$, unless otherwise specified

Symbol	Parameter	Rating	Unit
$V_{(BR)DSS}$	Drain-Source breakdown voltage	60	V
I_S	Diode continuous forward current	$T_C=25^\circ\text{C}$	55 A
I_D	Continuous drain current @ $V_{GS}=10V$	$T_C=25^\circ\text{C}$	55 A
		$T_C=100^\circ\text{C}$	35 A
I_{DM}	Pulse drain current tested ①	$T_C=25^\circ\text{C}$	200 A
P_D	Maximum power dissipation	$T_C=25^\circ\text{C}$	115 W
V_{GS}	Gate-Source voltage	± 20	V
$T_{STG} T_J$	Storage and operating temperature range	-55 to 175	$^\circ\text{C}$

Thermal Characteristics

Symbol	Parameter	Typical	Unit
$R_{\theta JC}$	Thermal Resistance-Junction to Case	1.3	$^\circ\text{C/W}$
$R_{\theta JA}$	Thermal Resistance Junction-Ambient	50	$^\circ\text{C/W}$

Drain-Source Avalanche Ratings

EAS	Avalanche Energy, Single Pulsed ③	156	mJ
-----	-----------------------------------	-----	----

Typical Characteristics

Symbol	Parameter	Condition	Min.	Typ.	Max.	Unit
Static Electrical Characteristics @ T_j = 25°C (unless otherwise stated)						
V _{(BR)DSS}	Drain-Source Breakdown Voltage	V _{GS} =0V, I _D =250μA	60	--	--	V
I _{DSS}	Zero Gate Voltage Drain Current	V _{DS} =60V, V _{GS} =0V	--	--	1	μA
	Zero Gate Voltage Drain Current(T _j =125°C)	V _{DS} =60V, V _{GS} =0V	--	--	100	μA
I _{GSS}	Gate-Body Leakage Current	V _{GS} =±20V, V _{DS} =0V	--	--	±100	nA
V _{GS(TH)}	Gate Threshold Voltage	V _{DS} =V _{GS} , I _D =250μA	1.0	1.8	2.5	V
R _{DS(ON)}	Drain-Source On-State Resistance ^③	V _{GS} =10V, I _D =40A	--	8.4	12	mΩ
R _{DS(ON)}	Drain-Source On-State Resistance ^③	V _{GS} =4.5V, I _D =20A	--	9.8	14	mΩ
Dynamic Electrical Characteristics @ T_j = 25°C (unless otherwise stated)						
C _{iss}	Input Capacitance	V _{DS} =30V, V _{GS} =0V, f=1MHz	--	1905	--	pF
C _{oss}	Output Capacitance		--	205	--	pF
C _{rss}	Reverse Transfer Capacitance		--	185	--	pF
R _g	Gate Resistance	f=1MHz		2.3		Ω
Q _g	Total Gate Charge	V _{DS} =30V, I _D =10A, V _{GS} =10V	--	26	--	nC
Q _{gs}	Gate-Source Charge		--	6.5	--	nC
Q _{gd}	Gate-Drain Charge		--	4.5	--	nC
Switching Characteristics						
t _{d(on)}	Turn-on Delay Time	V _{DD} =30V, I _D =10A, R _G =6.8Ω, V _{GS} =10V	--	9	--	nS
t _r	Turn-on Rise Time		--	5	--	nS
t _{d(off)}	Turn-Off Delay Time		--	28	--	nS
t _f	Turn-Off Fall Time		--	4	--	nS
Source- Drain Diode Characteristics @ T_j = 25°C (unless otherwise stated)						
V _{SD}	Forward on voltage	I _{SD} =40A, V _{GS} =0V	--	0.90	1.2	V
t _{rr}	Reverse Recovery Time	T _j =25°C, I _{sd} =20A, V _{GS} =0V	--	23	--	nS
Q _{rr}	Reverse Recovery Charge	di/dt=100A/μs		52		nC

NOTE:

- ① Repetitive rating; pulse width limited by max. junction temperature.
- ② Limited by T_{Jmax}, starting T_J = 25°C, L = 0.1mH, R_G = 25Ω, I_{AS} = 56A, V_{GS} = 10V. Part not recommended for use above this value
- ③ Pulse width ≤ 300μs; duty cycles ≤ 2%.

Typical Characteristics

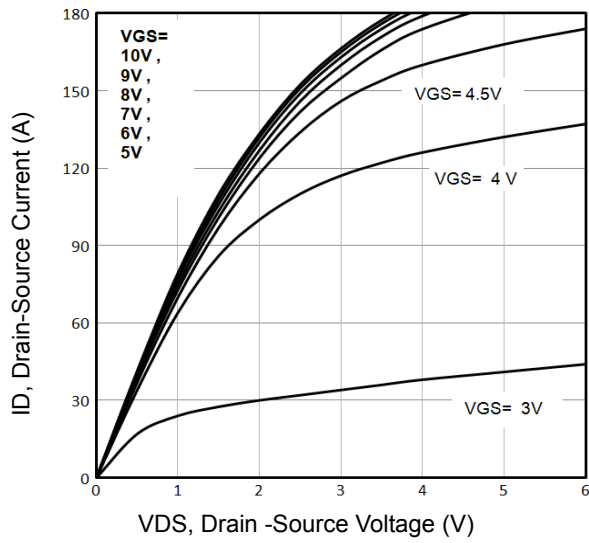

Fig1. Typical Output Characteristics

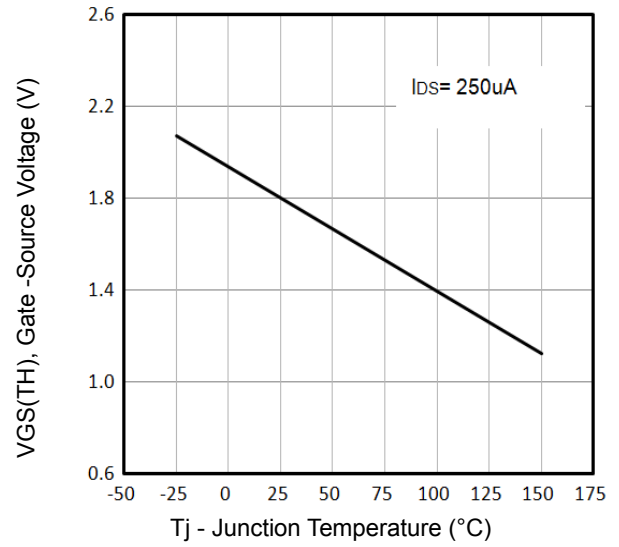

Fig2. $V_{GS(TH)}$ Gate -Source Voltage Vs. T_j

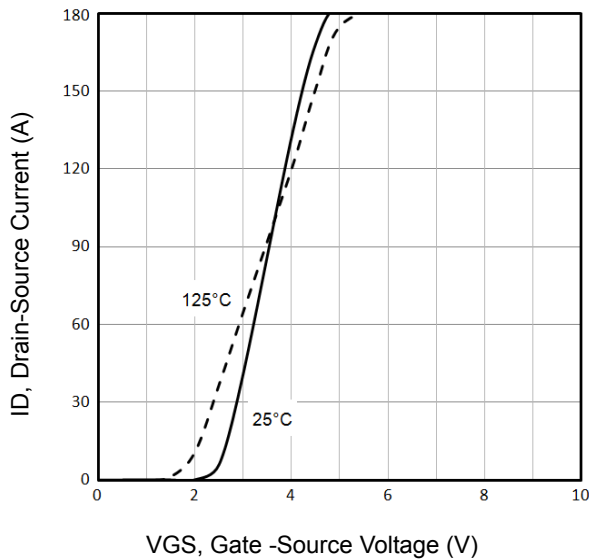

Fig3. Typical Transfer Characteristics

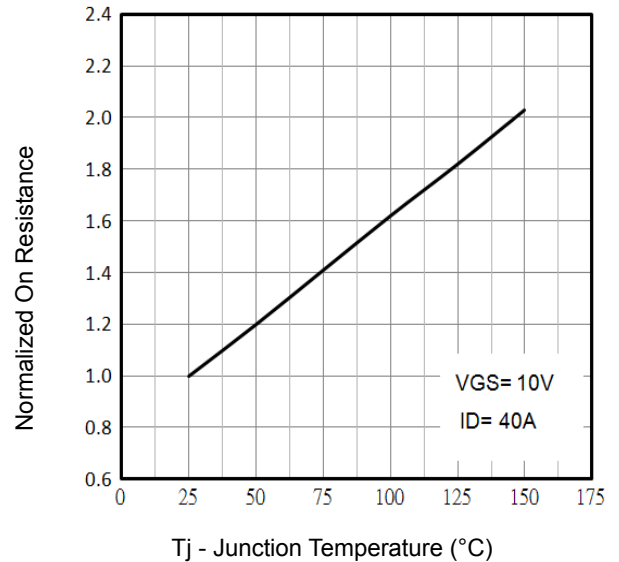

Fig4. Normalized On-Resistance Vs. Temperature

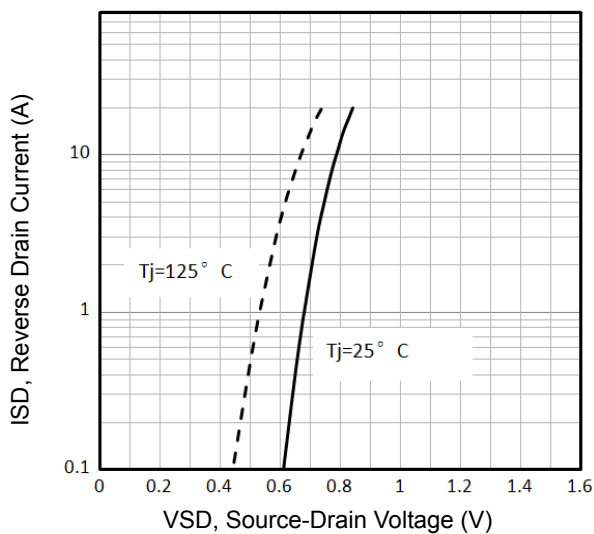

Fig5. Typical Source-Drain Diode Forward Voltage

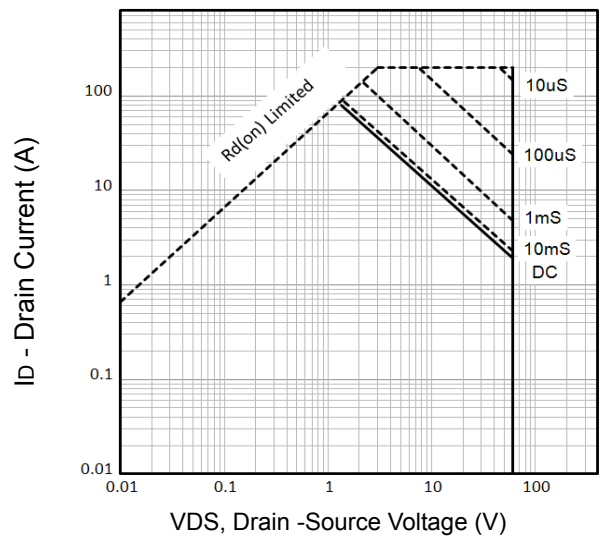

Fig6. Maximum Safe Operating Area

Typical Characteristics

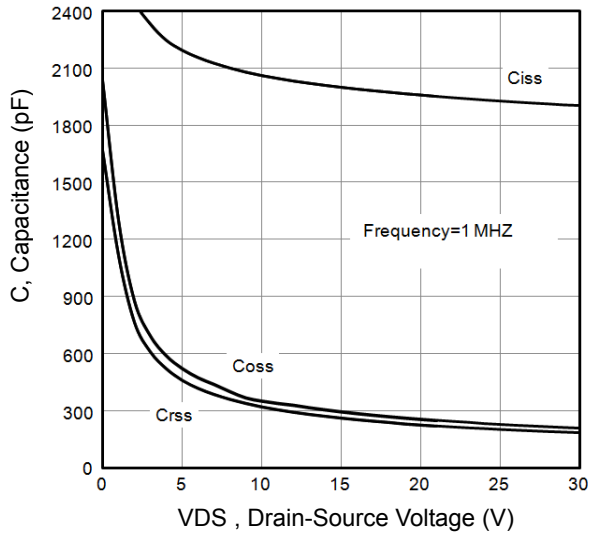

Fig7. Typical Capacitance Vs. Drain-Source Voltage

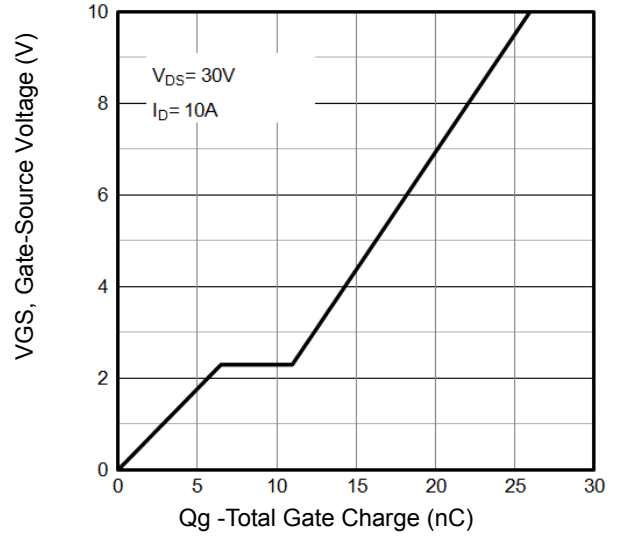

Fig8. Typical Gate Charge Vs. Gate-Source Voltage

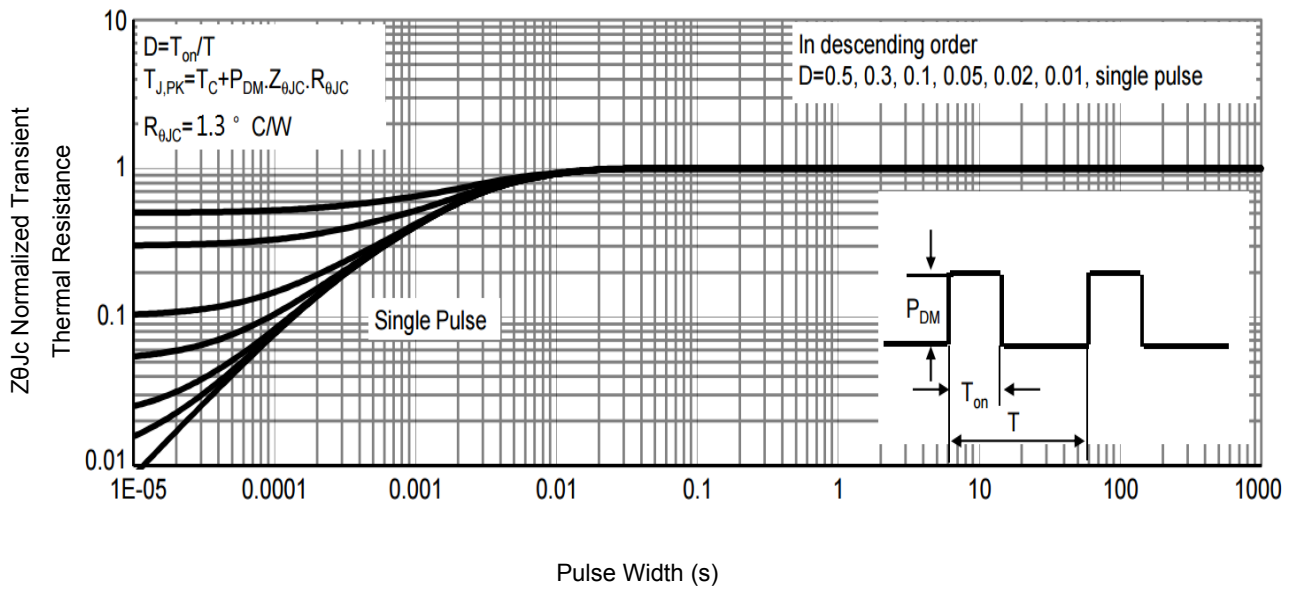

Fig9 . Normalized Maximum Transient Thermal Impedance

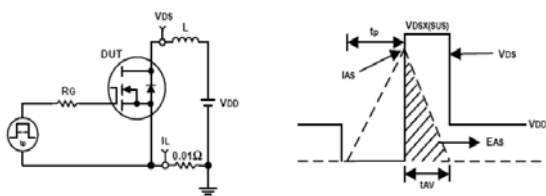

Fig10. Unclamped Inductive Test Circuit and waveforms

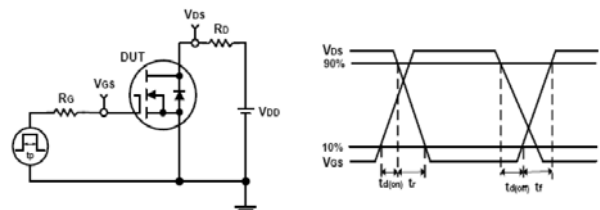
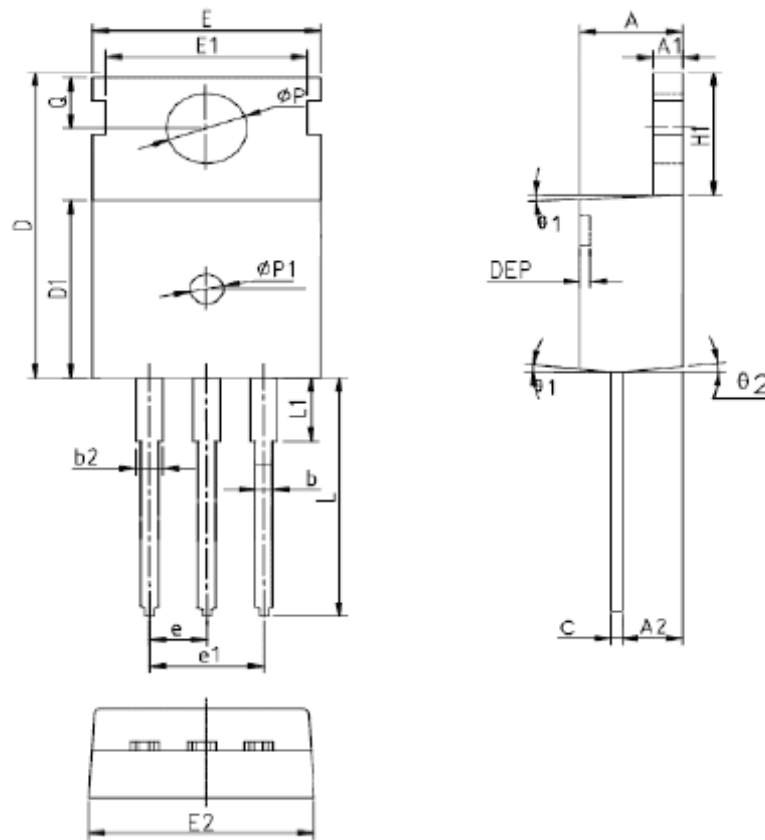

Fig11. Switching Time Test Circuit and waveforms

TO-220AB Package Outline Data



SYMBOL	MM			INCH			SYMBOL	MM			INCH		
	MIN	NOM	MAX	MIN	NOM	MAX		MIN	NOM	MAX	MIN	NOM	MAX
A	4.40	4.57	4.70	0.173	0.180	0.185	$\phi p1$	1.40	1.50	1.60	0.055	0.059	0.063
A1	1.27	1.30	1.33	0.050	0.051	0.052	e	2.54BSC			0.1BSC		
A2	2.35	2.40	2.50	0.093	0.094	0.098	e1	5.08BSC			0.2BSC		
b	0.77	-	0.90	0.030	-	0.035	H1	6.40	6.50	6.60	0.252	0.256	0.260
b2	1.23	-	1.36	0.048	-	0.054	L	12.75	-	13.17	0.502	-	0.519
C	0.48	0.50	0.52	0.019	0.020	0.021	L1	-	-	3.95	-	-	0.156
D	15.40	15.60	15.80	0.606	0.614	0.622	L2	2.50REF.			0.098REF.		
D1	9.00	9.10	9.20	0.354	0.358	0.362	ϕp	3.57	3.60	3.63	0.141	0.142	0.143
DEP	0.05	0.10	0.20	0.002	0.004	0.008	Q	2.73	2.80	2.87	0.107	0.110	0.113
E	9.70	9.90	10.10	0.382	0.389	0.398	$\theta 1$	5°	7°	9°	5°	7°	9°
E1	-	8.70	-	-	0.343	-	$\theta 2$	1°	3°	5°	1°	3°	5°
E2	9.80	10.00	10.20	0.386	0.394	0.401							

Customer Service

Sales and Service:

sales@vgsemi.com

Vanguard Semiconductor CO., LTD

TEL: (86-755) -26902410

FAX: (86-755) -26907027

WEB: www.vgsemi.com