

## Features

- N-Channel
- Enhancement mode
- Very low on-resistance  $R_{DS(on)}$  @  $V_{GS}=4.5V$
- Fast Switching
- 100% Avalanche Tested
- Pb-free lead plating; RoHS compliant



Part ID	Package Type	Marking	Tape and reel information
VSB012N03MS	TDFN3.3x3.3	012N03M	5000pcs/Reel

$V_{DS}$	30	V
$R_{DS(on),TYP} @ V_{GS}=10V$	9	m $\Omega$
$R_{DS(on),TYP} @ V_{GS}=4.5V$	12	m $\Omega$
$I_D$	38	A

### TDFN3.3x3.3

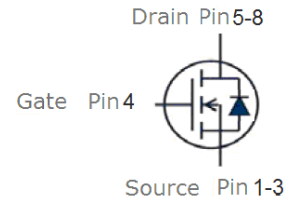
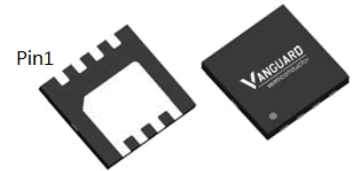

## Maximum ratings, at $T_j=25^\circ\text{C}$ , unless otherwise specified

Symbol	Parameter	Rating	Unit
$V_{(BR)DSS}$	Drain-Source breakdown voltage	30	V
$I_S$	Diode continuous forward current	$T_C=25^\circ\text{C}$ 38	A
$I_D$	Continuous drain current @ $V_{GS}=10V$	$T_C=25^\circ\text{C}$ 38	A
		$T_A=100^\circ\text{C}$ 24	A
$I_{DM}$	Pulse drain current tested ①	$T_C=25^\circ\text{C}$ 150	A
EAS	Avalanche energy, single pulsed ②	$I_D=20A$ 48	mJ
IAS	Avalanche energy, single pulsed ②	30	A
$P_D$	Maximum power dissipation	$T_A=25^\circ\text{C}$ 41	W
$V_{GS}$	Gate-Source voltage	$\pm 20$	V
$T_{STG} T_J$	Storage and operating temperature range	-55 to 150	$^\circ\text{C}$

## Thermal Characteristics

Symbol	Parameter	Typical	Unit
$R_{\theta JC}$	Thermal Resistance-Junction to Case	3	$^\circ\text{C/W}$
$R_{\theta JA}$	Thermal Resistance Junction-Ambient	45	$^\circ\text{C/W}$

**Typical Characteristics**

Symbol	Parameter	Condition	Min.	Typ.	Max.	Unit
<b>Static Electrical Characteristics @ T<sub>c</sub> = 25°C (unless otherwise stated)</b>						
V <sub>(BR)DSS</sub>	Drain-Source Breakdown Voltage	V <sub>GS</sub> =0V, I <sub>D</sub> =250μA	30	--	--	V
I <sub>DSS</sub>	Zero Gate Voltage Drain Current(T <sub>c</sub> =25°C)	V <sub>DS</sub> =24V, V <sub>GS</sub> =0V	--	--	1	μA
	Zero Gate Voltage Drain Current(T <sub>c</sub> =125°C)	V <sub>DS</sub> =24V, V <sub>GS</sub> =0V	--	--	100	μA
I <sub>GSS</sub>	Gate-Body Leakage Current	V <sub>GS</sub> =±20V, V <sub>DS</sub> =0V	--	--	±100	nA
V <sub>GS(TH)</sub>	Gate Threshold Voltage	V <sub>DS</sub> =V <sub>GS</sub> , I <sub>D</sub> =250μA	0.8	1.5	2.2	V
R <sub>DS(ON)</sub>	Drain-Source On-State Resistance <sup>③</sup>	V <sub>GS</sub> =10V, I <sub>D</sub> =25A	--	9	12	mΩ
R <sub>DS(ON)</sub>	Drain-Source On-State Resistance <sup>③</sup>	V <sub>GS</sub> =4.5V, I <sub>D</sub> =10A	--	12	16	mΩ
<b>Dynamic Electrical Characteristics @ T<sub>c</sub> = 25°C (unless otherwise stated)</b>						
C <sub>iss</sub>	Input Capacitance	V <sub>DS</sub> =15V, V <sub>GS</sub> =0V, f=1MHz	--	980	--	pF
C <sub>oss</sub>	Output Capacitance		--	160	--	pF
C <sub>rss</sub>	Reverse Transfer Capacitance		--	115	--	pF
Q <sub>g</sub>	Total Gate Charge	V <sub>DS</sub> =15V, I <sub>D</sub> =20A, V <sub>GS</sub> =10V	--	18	--	nC
Q <sub>gs</sub>	Gate-Source Charge		--	4.5	--	nC
Q <sub>gd</sub>	Gate-Drain Charge		--	5.5	--	nC
<b>Switching Characteristics</b>						
t <sub>d(on)</sub>	Turn-on Delay Time	V <sub>DD</sub> =15V, I <sub>D</sub> =10A, R <sub>G</sub> =6.8Ω, V <sub>GS</sub> =10V	--	7	--	nS
t <sub>r</sub>	Turn-on Rise Time		--	14	--	nS
t <sub>d(off)</sub>	Turn-Off Delay Time		--	22	--	nS
t <sub>f</sub>	Turn-Off Fall Time		--	8	--	nS
<b>Source- Drain Diode Characteristics @ T<sub>c</sub> = 25°C (unless otherwise stated)</b>						
V <sub>SD</sub>	Forward on voltage	I <sub>SD</sub> =2A, V <sub>GS</sub> =0V	--	0.74	1.2	V
t <sub>rr</sub>	Reverse Recovery Time	T <sub>j</sub> =25°C, I <sub>sd</sub> =10A, V <sub>GS</sub> =0V	--	21	--	nS
Q <sub>rr</sub>	Reverse Recovery Charge		di/dt=100A/μs		11	

**NOTE:**

- ① Repetitive rating; pulse width limited by max. junction temperature.
- ② Limited by T<sub>Jmax</sub>, starting T<sub>J</sub> = 25°C, L = 0.3mH, R<sub>G</sub> = 25Ω, I<sub>AS</sub> = 18A, V<sub>GS</sub> = 10V. Part not recommended for use above this value
- ③ Pulse width ≤ 300μs; duty cycle ≤ 2%.

**Typical Characteristics**

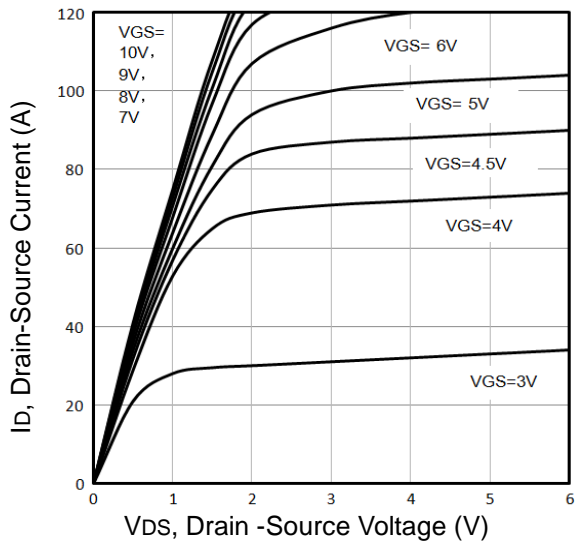

Fig1. Typical Output Characteristics

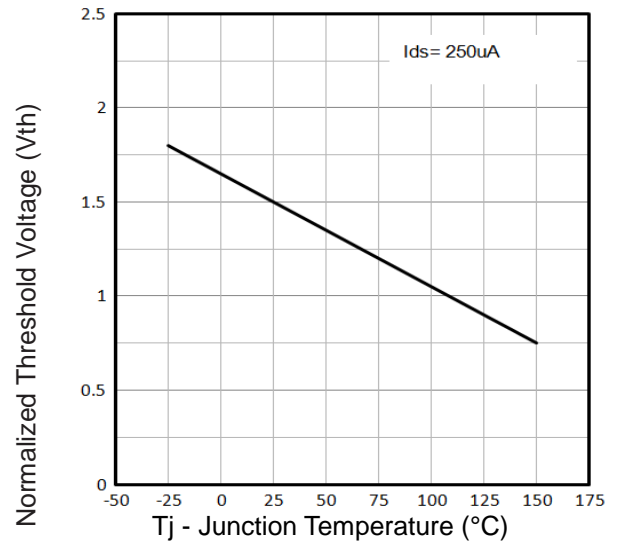

Fig2. Normalized Threshold Voltage Vs. Temperature

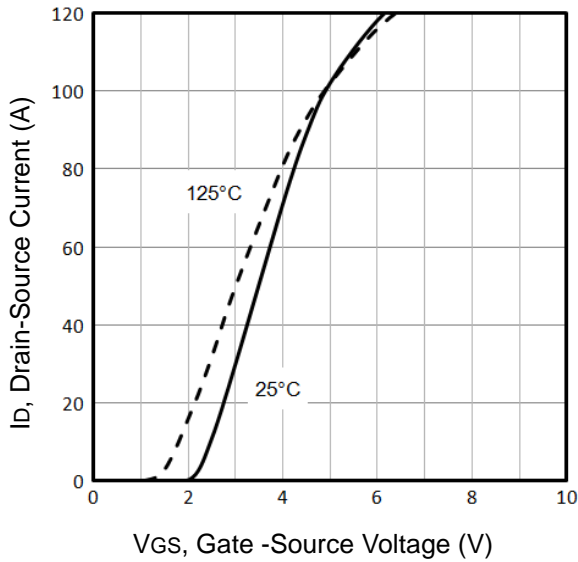

Fig3. Typical Transfer Characteristics

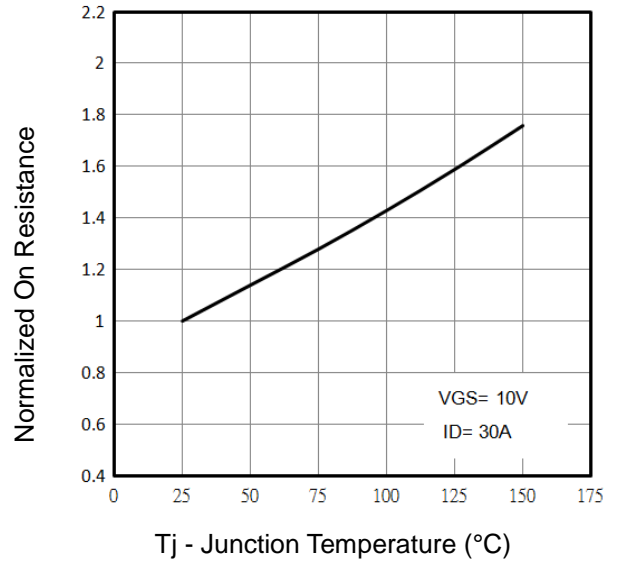

Fig4. Normalized On-Resistance Vs. Temperature

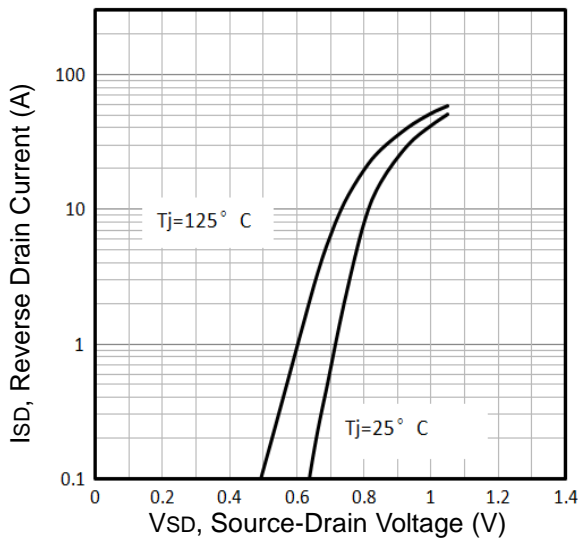

Fig5. Typical Source-Drain Diode Forward Voltage

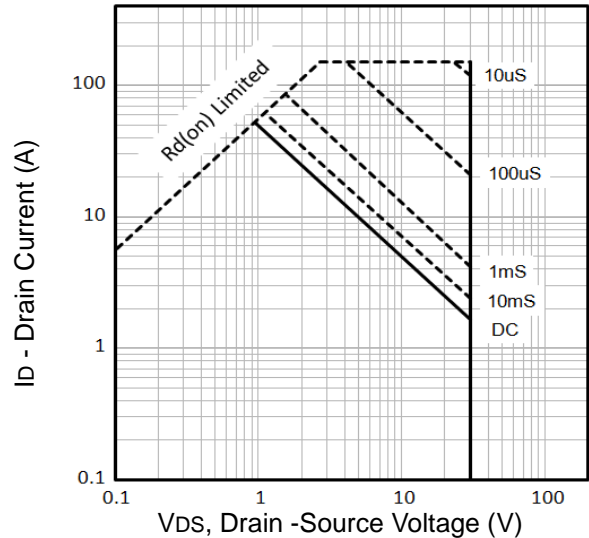

Fig6. Maximum Safe Operating Area

**Typical Characteristics**

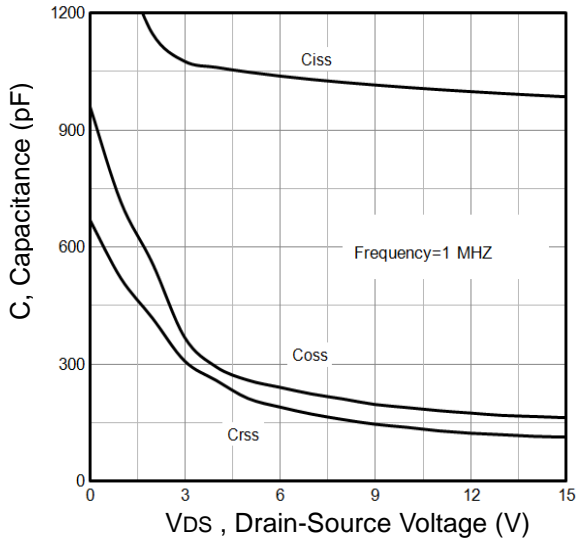

Fig7. Typical Capacitance Vs.Drain-Source Voltage

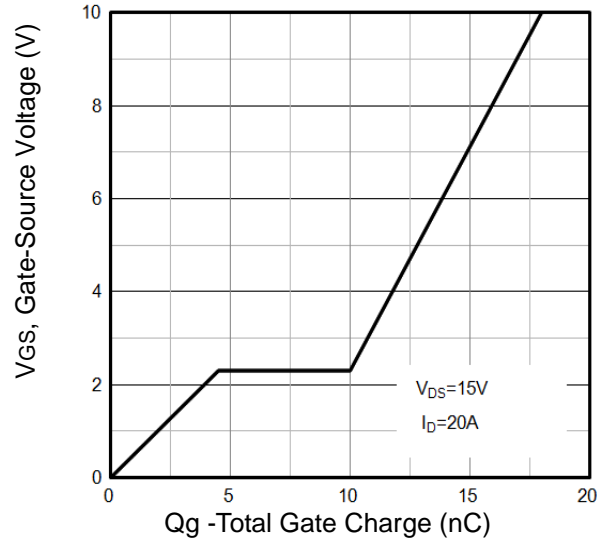

Fig8. Typical Gate Charge Vs.Gate-Source

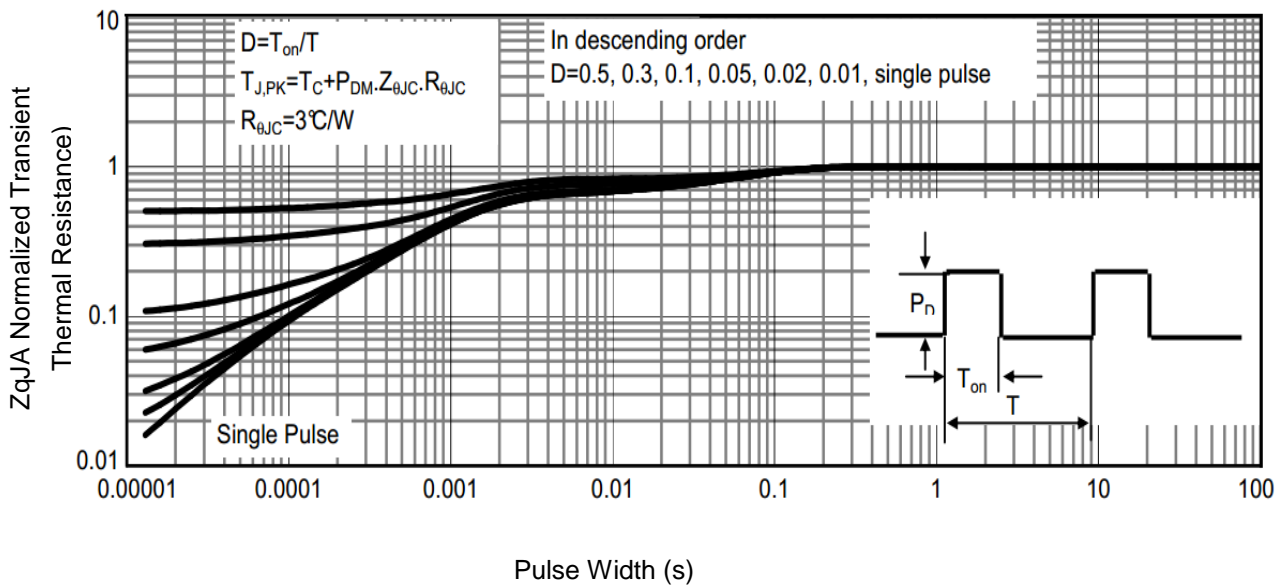

Fig 9 . Normalized Maximum Transient Thermal Impedance

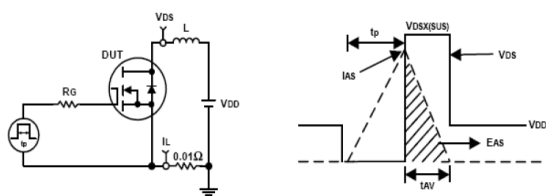

Fig10. Unclamped Inductive Test Circuit and waveforms

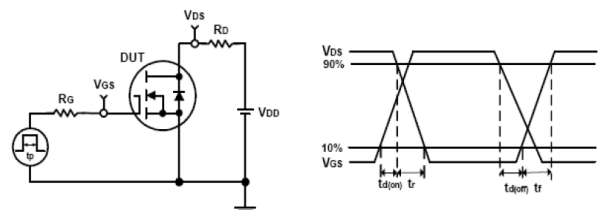
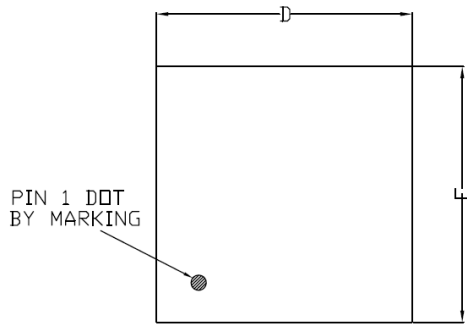
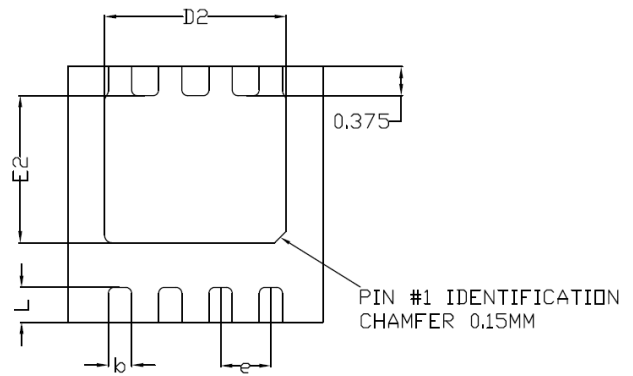

Fig11. Switching Time Test Circuit and waveforms

**TDFN3.3x3.3 Package Outline Data**



TOP VIEW



BOTTOM VIEW

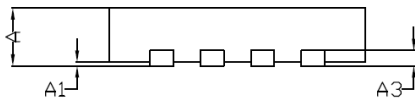

SIDE VIEW

Lead finish : NiPdAu

**DIMENSIONS** ( unit : mm )

Symbol	Min	Typ	Max	Symbol	Min	Typ	Max
A	0.70	0.75	0.80	A1	0.00	--	0.05
A3	0.20 REF			D	3.25	3.30	3.35
E	3.25	3.30	3.35	D2	2.30	2.35	2.40
E2	1.85	1.90	1.95	b	0.25	0.30	0.35
L	0.35	0.45	0.55	e	0.65 BSC		

**Customer Service**

Sales and Service:

[Sales@vgsemi.com](mailto:Sales@vgsemi.com)

**Vanguard Semiconductor CO., LTD**

TEL: (86-755) -26902410

FAX: (86-755) -26907027

WEB: [www.vgsemi.com](http://www.vgsemi.com)