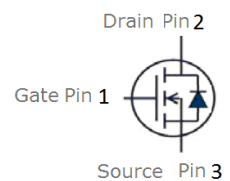

Features

- Enhancement mode
- Fast Switching
- Low on-resistance $R_{DS(on)}$ @ $V_{GS}=4.5V$
- 100% Avalanche test
- Pb-free lead plating; RoHS compliant

Halogen-Free

V_{DS}	100	V
$R_{DS(on),TYP} @ V_{GS}=10V$	10	m Ω
$R_{DS(on),TYP} @ V_{GS}=4.5V$	11	m Ω
I_D	43	A

TO-220F

Part ID	Package Type	Marking	Tape and reel information
VSF013N10MS	TO-220F	013N10M	50pcs/Tube

Maximum ratings, at $T_A=25^\circ\text{C}$, unless otherwise specified

Symbol	Parameter	Rating	Unit
$V_{(BR)DSS}$	Drain-Source breakdown voltage	100	V
V_{GS}	Gate-Source voltage	± 20	V
I_S	Diode continuous forward current	$T_C=25^\circ\text{C}$	43 A
I_D	Continuous drain current @ $V_{GS}=10V$	$T_C=25^\circ\text{C}$	43 A
		$T_C=100^\circ\text{C}$	30 A
I_{DM}	Pulse drain current tested ①	$T_C=25^\circ\text{C}$	172 A
I_{DSM}	Continuous drain current @ $V_{GS}=10V$	$T_A=25^\circ\text{C}$	9 A
		$T_A=70^\circ\text{C}$	7 A
EAS	Avalanche energy, single pulsed ②	81	mJ
P_D	Maximum power dissipation	$T_C=25^\circ\text{C}$	47 W
		$T_C=100^\circ\text{C}$	23 W
P_{DSM}	Maximum power dissipation ③	$T_A=25^\circ\text{C}$	2 W
		$T_A=70^\circ\text{C}$	1.3 W
T_{STG}, T_J	Storage and Junction Temperature Range	-55 to 175	$^\circ\text{C}$

Thermal Characteristics

Symbol	Parameter	Typical	Unit
$R_{\theta JC}$	Thermal Resistance, Junction-to-Case	3.2	$^\circ\text{C/W}$
$R_{\theta JA}$	Thermal Resistance, Junction-to-Ambient	62.5	$^\circ\text{C/W}$

Electrical Characteristics

Symbol	Parameter	Condition	Min.	Typ.	Max.	Unit
Static Electrical Characteristics @ T_j=25°C (unless otherwise stated)						
V _{(BR)DSS}	Drain-Source Breakdown Voltage	V _{GS} =0V, I _D =250μA	100	--	--	V
I _{DSS}	Zero Gate Voltage Drain Current	V _{DS} =100V, V _{GS} =0V	--	--	1	μA
	Zero Gate Voltage Drain Current (T _j =125°C)	V _{DS} =100V, V _{GS} =0V	--	--	100	μA
I _{GSS}	Gate-Body Leakage Current	V _{GS} =±20V, V _{DS} =0V	--	--	±100	nA
V _{GS(TH)}	Gate Threshold Voltage	V _{DS} =V _{GS} , I _D =250μA	1.2	1.7	2.4	V
R _{DS(ON)}	Drain-Source On-State Resistance ^④	V _{GS} =10V, I _D =40A	--	10	15	mΩ
		T _j =100°C	--	16	--	mΩ
R _{DS(ON)}	Drain-Source On-State Resistance ^④	V _{GS} =4.5V, I _D =20A	--	11	16	mΩ
Dynamic Electrical Characteristics @ T_c = 25°C (unless otherwise stated)						
C _{iss}	Input Capacitance	V _{DS} =30V, V _{GS} =0V, f=1MHz	3390	3990	4590	pF
C _{oss}	Output Capacitance		215	255	295	pF
C _{rss}	Reverse Transfer Capacitance		190	225	260	pF
R _g	Gate Resistance	f=1MHz	--	2	--	Ω
Q _g (10V)	Total Gate Charge	V _{DS} =50V, I _D =30A, V _{GS} =10V	--	82	--	nC
Q _g (4.5V)	Total Gate Charge		--	42	--	nC
Q _{gs}	Gate-Source Charge		--	11	--	nC
Q _{gd}	Gate-Drain Charge		--	20	--	nC
Switching Characteristics						
t _{d(on)}	Turn-on Delay Time	V _{DD} =50V, I _D =33A, R _G =3Ω, V _{GS} =10V	--	11	--	ns
t _r	Turn-on Rise Time		--	46	--	ns
t _{d(off)}	Turn-Off Delay Time		--	70	--	ns
t _f	Turn-Off Fall Time		--	89	--	ns
Source- Drain Diode Characteristics @ T_c = 25°C (unless otherwise stated)						
V _{SD}	Forward on voltage	I _{SD} =40A, V _{GS} =0V	--	0.9	1.2	V
t _{rr}	Reverse Recovery Time	T _j =25°C, I _{sd} =30A, V _{GS} =0V	--	29	--	ns
Q _{rr}	Reverse Recovery Charge	di/dt=100A/μs	--	30	--	nC

NOTE:

- ① Repetitive rating; pulse width limited by max junction temperature.
- ② Limited by T_{Jmax}, starting T_J = 25°C, L = 0.5mH, R_G = 25Ω, I_{AS} = 18A, V_{GS} = 10V. Part not recommended for use above this value
- ③ The power dissipation P_{DSM} is based on R_{θJA} and the maximum allowed junction temperature of 150°C.
- ④ Pulse width ≤ 380μs; duty cycle ≤ 2%.

Typical Characteristics

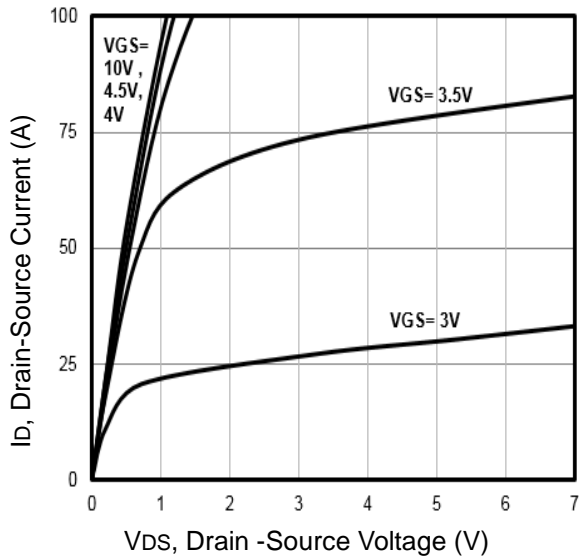

Fig1. Typical Output Characteristics

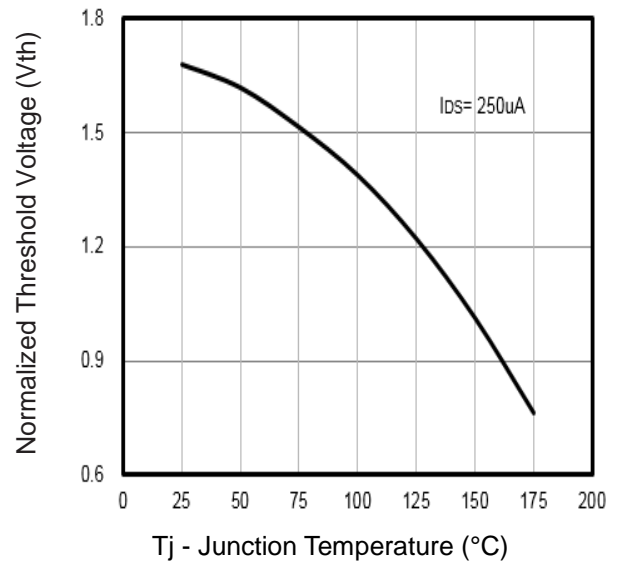

Fig2. Normalized Threshold Voltage Vs. Temperature

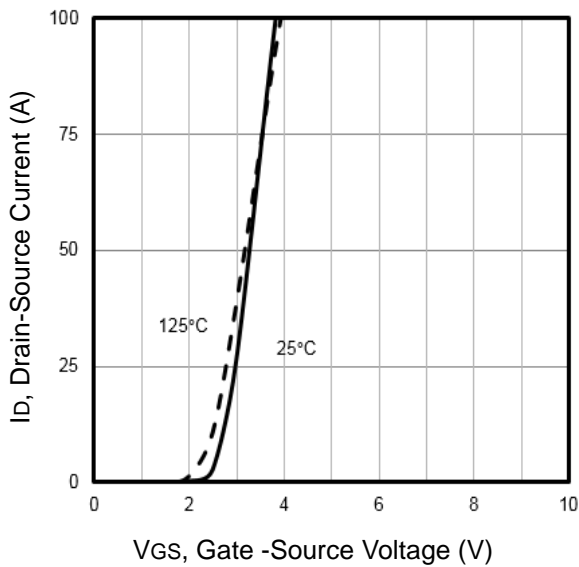

Fig3. Typical Transfer Characteristics

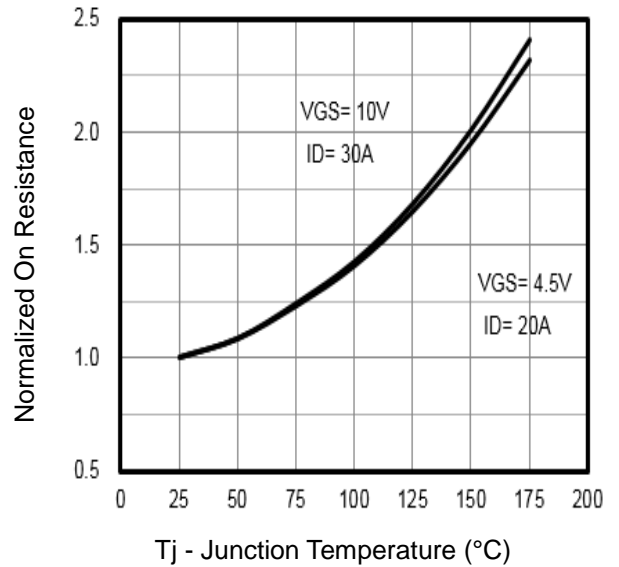

Fig4. Normalized On-Resistance Vs. Temperature

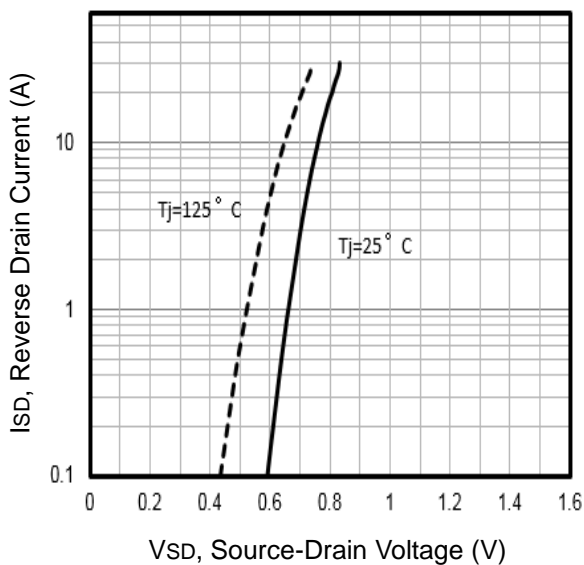

Fig5. Typical Source-Drain Diode Forward Voltage

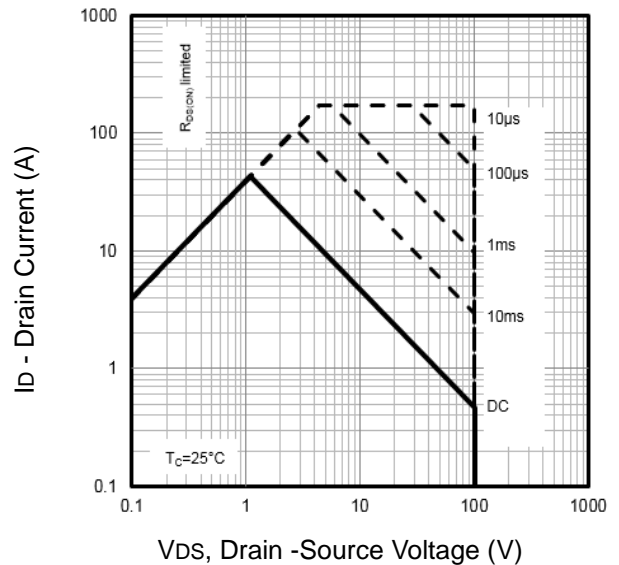

Fig6. Maximum Safe Operating Area

Typical Characteristics

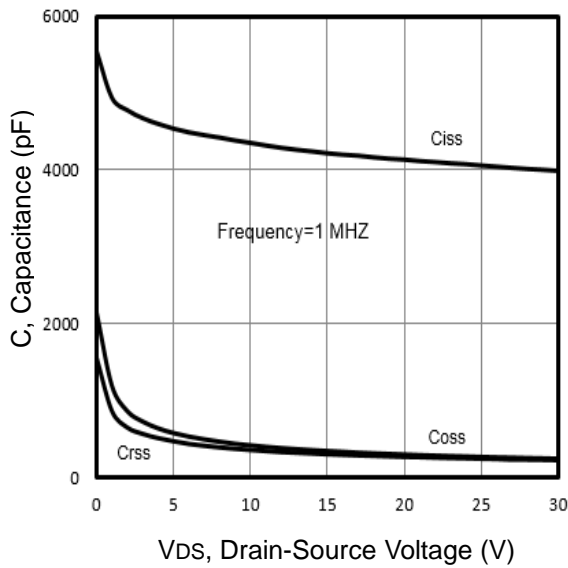

Fig7. Typical Capacitance Vs. Drain-Source

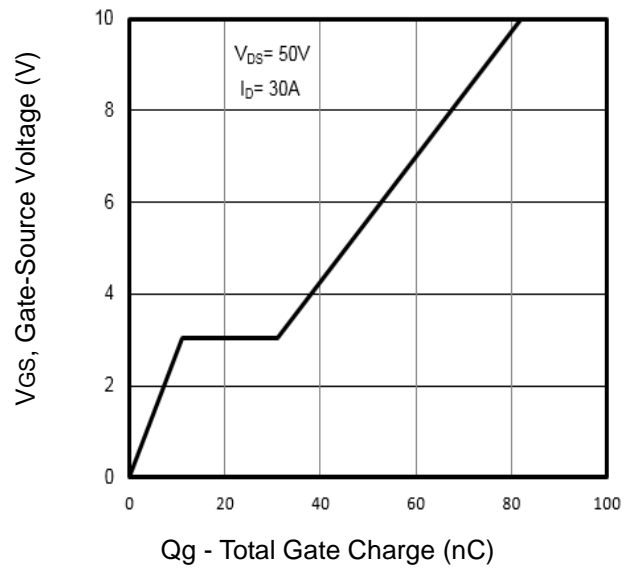

Fig8. Typical Gate Charge Vs. Gate-Source

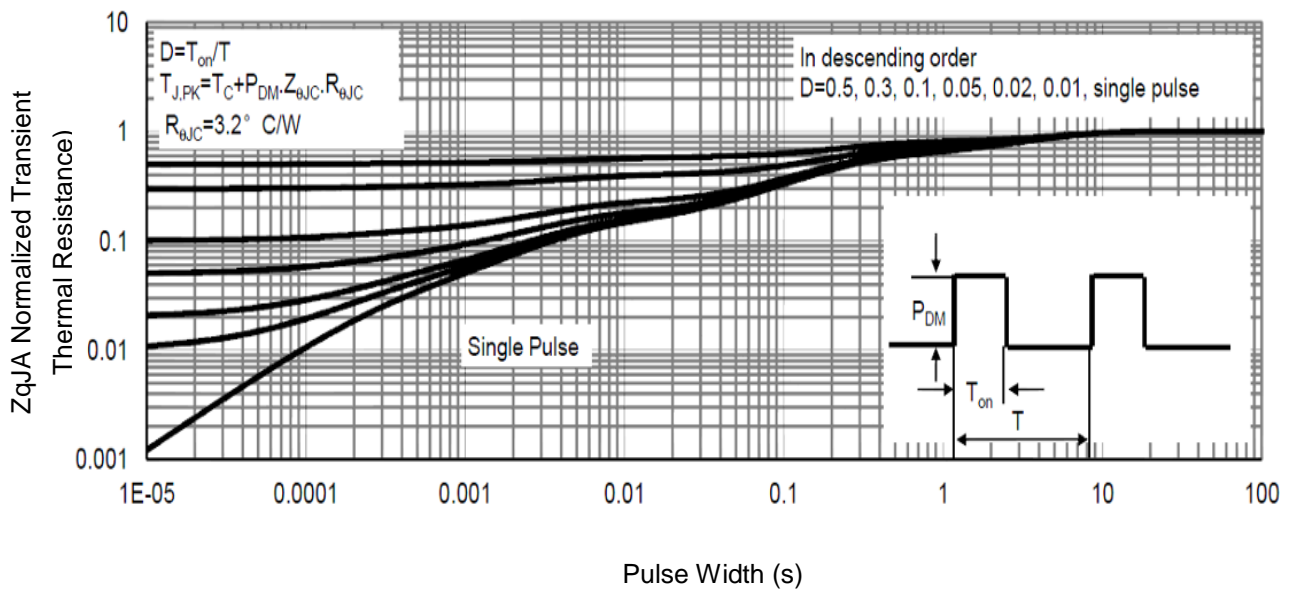

Fig9. Normalized Maximum Transient Thermal Impedance

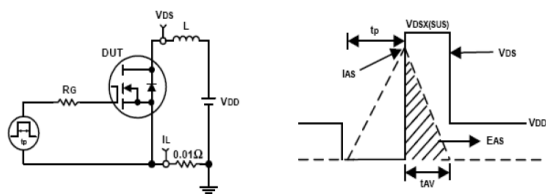

Fig10. Unclamped Inductive Test Circuit and waveforms

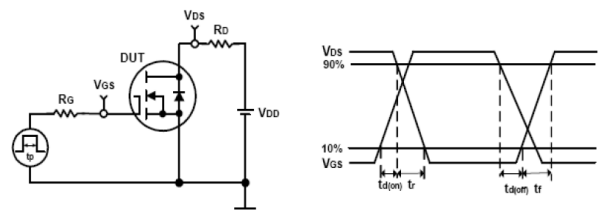
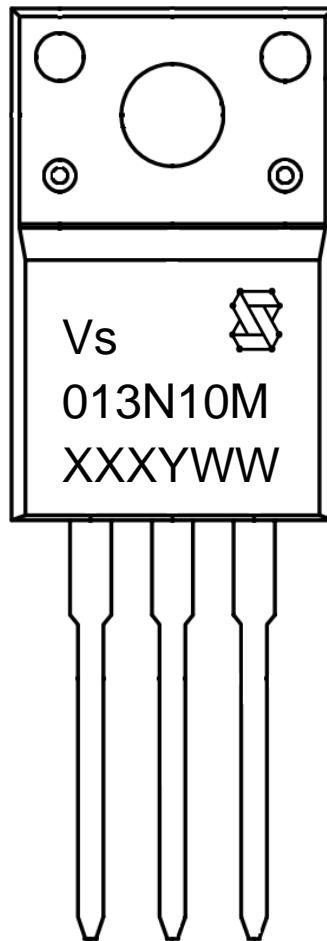

Fig11. Switching Time Test Circuit and waveforms

Marking Information



1st line: Vanguard Code (Vs), Vanguard Logo

2nd line: Part Number (013N10M)

3rd line: Date code (XXXYWW)

XXX: Wafer Lot Number Code , code changed with Lot Number

Y: Year Code, (e.g. E=2017, F=2018, G=2019, H=2020, etc)

WW: Week Code (01 to 53)

TO-220F Package Outline Data

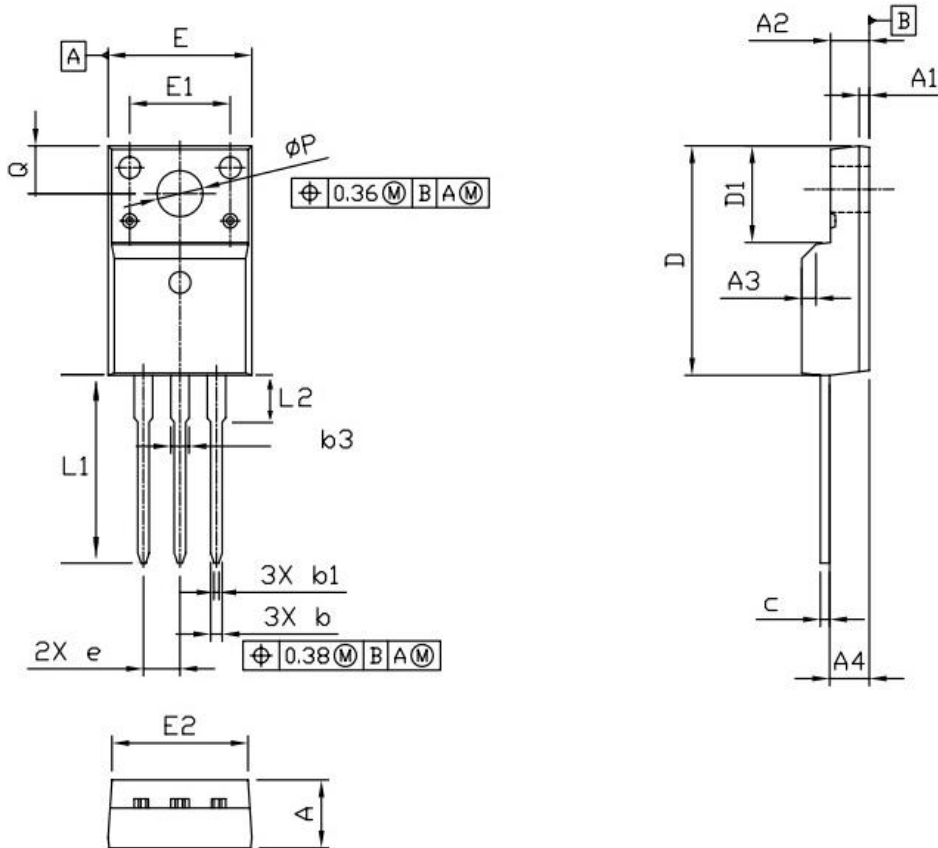

Symbol	Dimensions (unit: mm)		
	Min	Typ	Max
A	4.40	4.70	5.00
A1	0.45	0.70	0.95
A2	2.30	2.55	2.80
A3	1.0 x 45°		
A4	2.45	2.76	3.05
b	0.60	0.80	1.00
b1	0.25	0.35	0.45
b3	1.18	--	1.47
c	0.30	0.50	0.70
D	15.40	15.90	16.40
D1	6.40	6.70	7.00
e	--	2.54	--
E	9.86	10.16	10.46
E1	6.80	7.00	7.20
E2	9.40	9.70	10.00
L1	12.30	12.80	13.30
L2	2.95	3.25	3.55
Q	3.05	3.30	3.55
φP	2.92	3.12	3.32

Customer Service

Sales and Service:

sales@vgsemi.com

Vanguard Semiconductor CO., LTD

TEL: (86-755) -26902410

FAX: (86-755) -26907027

WEB: www.vgsemi.com