

5N65GS

5 Amps,650 Volts N-Channel Super Junction Power MOSFET

FEATURE

- 5A,650V, $R_{DS(ON)MAX}=0.90\Omega @V_{GS}=10V/2.5A$
- Low gate charge
- Low C_{iss}
- Fast switching
- 100% avalanche tested
- Improved dv/dt capability

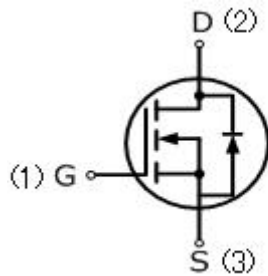

TO-252

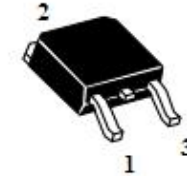

Absolute Maximum Ratings ($T_C=25^\circ\text{C}$, unless otherwise noted)

Parameter	Symbol	5N65GS	UNIT
Drain-Source Voltage	V_{DSS}	650	V
Gate-Source Voltage	V_{GSS}	± 25	
Continuous Drain Current	I_D	5	A
Pulsed Drain Current (Note 1)	I_{DM}	15	
Single Pulse Avalanche Energy (Note 2)	E_{AS}	100	mJ
Avalanche Current (Note 1)	I_{AR}	2.5	A
Repetitive Avalanche Energy (Note 1)	E_{AR}	0.4	mJ
Reverse Diode dV/dt (Note 3)	dV/dt	15	V/ns
Operating Junction and Storage Temperature Range	T_J, T_{STG}	-55 to +150	$^\circ\text{C}$
Maximum lead temperature for soldering purposes, 1/8" from case for 5 seconds	T_L	260	$^\circ\text{C}$

Thermal Characteristics

Parameter	Symbol	TO-252	Units
Thermal resistance, Channel to Case	$R_{th(ch-c)}$	2.55	$^\circ\text{C}/\text{W}$
Thermal resistance, Channel to Ambient	$R_{th(ch-a)}$	62	$^\circ\text{C}/\text{W}$
Maximum Power Dissipation	$T_C=25^\circ\text{C}$ P_D	45	W

Electrical Characteristics ($T_c=25^\circ\text{C}$, unless otherwise noted)						
Parameter	Symbol	Test Conditions	Min	Typ	Max	Units
Off Characteristics						
Drain-Source Breakdown Voltage	BV_{DSS}	$V_{GS}=0V, I_D=250\mu A$	650	—	—	V
Breakdown Temperature Coefficient	$\Delta BV_{DSS} / \Delta T_J$	Reference to 25°C , $I_D=250\mu A$	—	0.6	—	$V/^\circ\text{C}$
Zero Gate Voltage Drain Current	I_{DSS}	$V_{DS}=650V, V_{GS}=0V$	—	—	1	μA
Gate-Body Leakage Current, Forward	I_{GSSF}	$V_{GS}=20V, V_{DS}=0V$	—	—	100	nA
Gate-Body Leakage Current, Reverse	I_{GSSR}	$V_{GS}=-20V, V_{DS}=0V$	—	—	-100	nA
On Characteristics						
Gate-Source Threshold Voltage	$V_{GS(th)}$	$V_{DS}=V_{GS}, I_D=250\mu A$	2	—	4	V
Drain-Source On-State Resistance	$R_{DS(on)}$	$V_{GS}=10V, I_D=2.5A$	—	0.74	0.90	Ω
Dynamic Characteristics						
Input Capacitance	C_{iss}	$V_{DS}=50V, V_{GS}=0V,$ $f=1.0\text{MHz}$	—	460	—	pF
Output Capacitance	C_{oss}		—	45	—	pF
Reverse Transfer Capacitance	C_{rss}		—	3.5	—	pF
Switching Characteristics						
Turn-On Delay Time	$t_{d(on)}$	$V_{DD}=380V, I_D=5A,$ $R_G=18\Omega$ (Note4,5)	—	6	—	ns
Turn-On Rise Time	t_r		—	3	—	ns
Turn-Off Delay Time	$t_{d(off)}$		—	50	—	ns
Turn-Off Fall Time	t_f		—	9	—	ns
Total Gate Charge	Q_g	$V_{DS}=480V, I_D=5A,$ $V_{GS}=10V,$ (Note4,5)	—	10	—	nC
Gate-Source Charge	Q_{gs}		—	1.6	—	nC
Gate-Drain Charge	Q_{gd}		—	4.0	—	nC
Drain-Source Body Diode Characteristics and Maximum Ratings						
Continuous Diode Forward Current	I_S		—	—	5	A
Pulsed Diode Forward Current	I_{SM}		—	—	15	A
Diode Forward Voltage	V_{SD}	$I_S=5A, V_{GS}=0V$	—	—	1.3	V
Reverse Recovery Time	t_{rr}	$V_{GS}=0V, I_S=5A,$	—	250	—	ns
Reverse Recovery Charge	Q_{rr}	$dI_F/dt=100A/\mu s,$ (Note4)	—	2.2	—	μC

Notes

1. Repetitive Rating: pulse width limited by maximum junction temperature.
2. $V_{DD}=50V, L=10\text{mH}, R_g=25\Omega, I_{AS}=2.5A$, starting $T_J=25^\circ\text{C}$.
3. $I_{SD} \leq I_D, dI/dt=200A/\mu s, V_{DD} \leq BV_{DSS}$, starting $T_J=25^\circ\text{C}$.
4. Pulse width $\leq 300\mu s$; duty cycle $\leq 2\%$.
5. Repetitive rating; pulse width limited by maximum junction temperature.

TEST CIRCUIT AND WAVEFORM

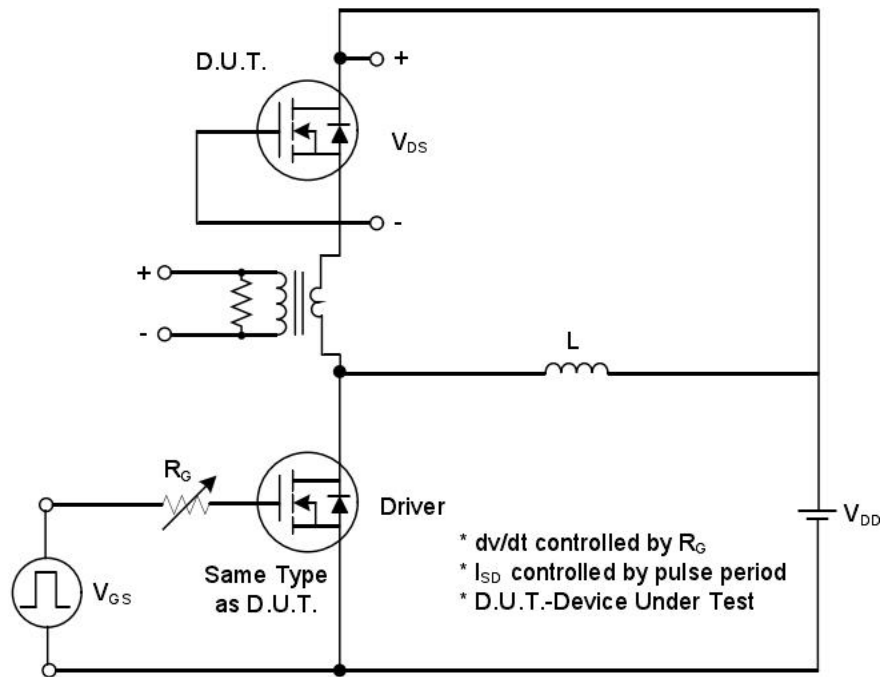

Peak Diode Recovery dv/dt Test Circuit

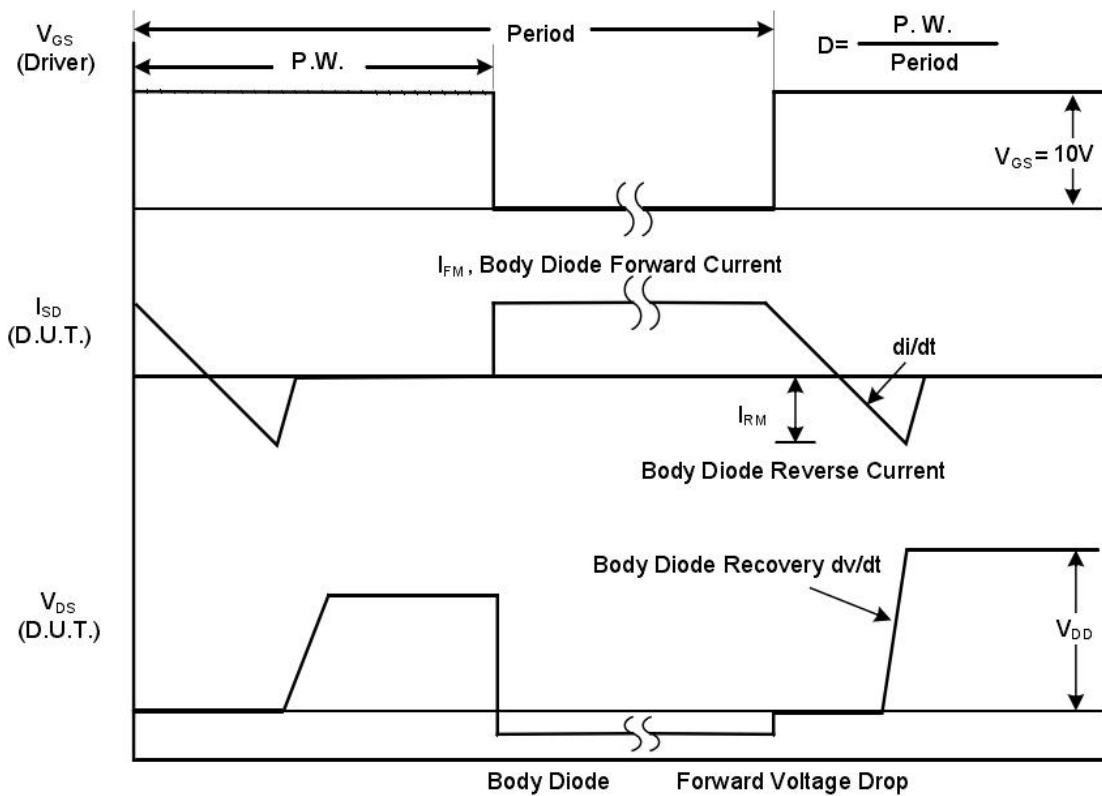

Peak Diode Recovery dv/dt Waveforms

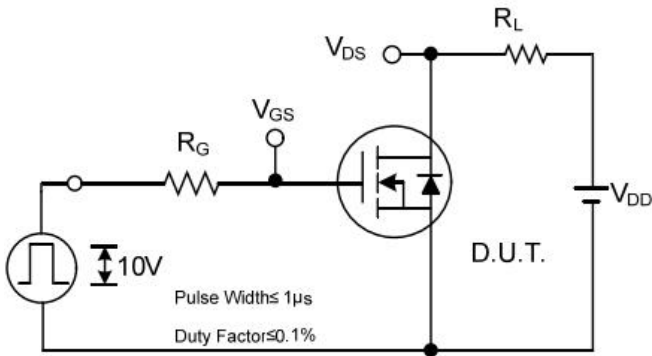

Switching Test Circuit

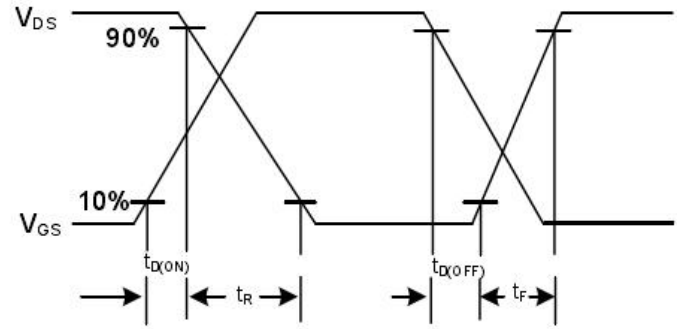

Switching Waveforms

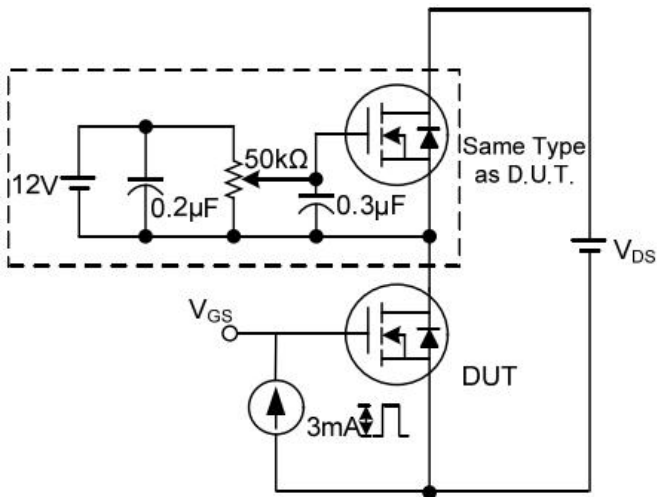

Gate Charge Test Circuit

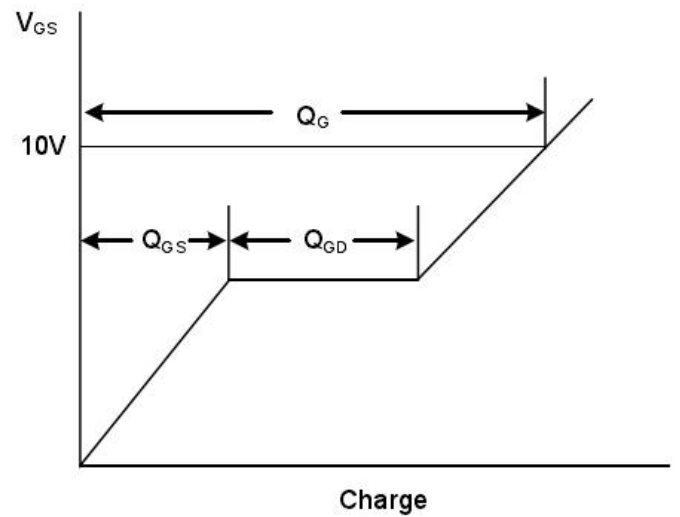

Gate Charge Waveform

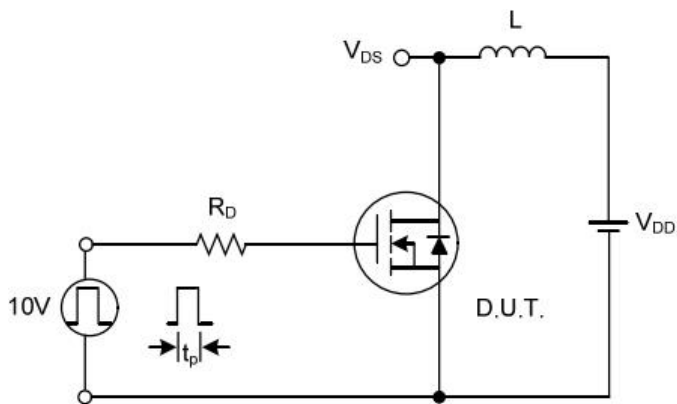

Unclamped Inductive Switching Test Circuit

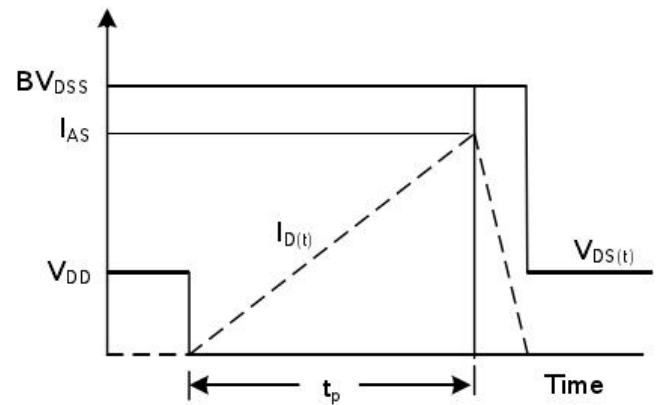

Unclamped Inductive Switching Waveforms

RATING AND CHARACTERISTIC CURVES

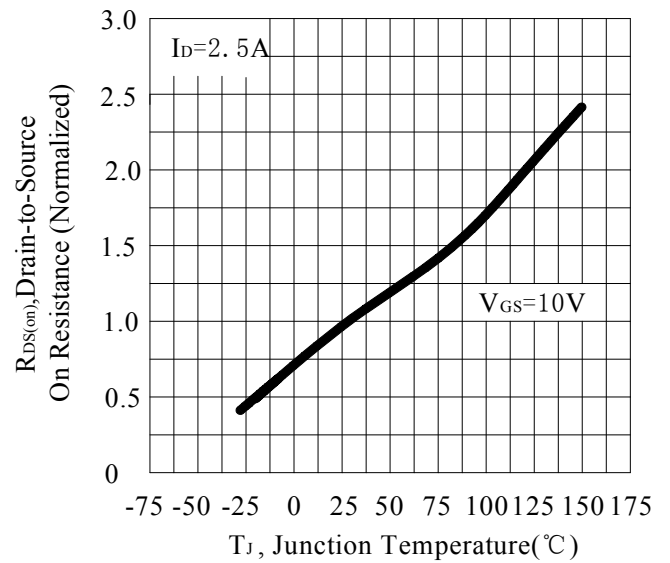
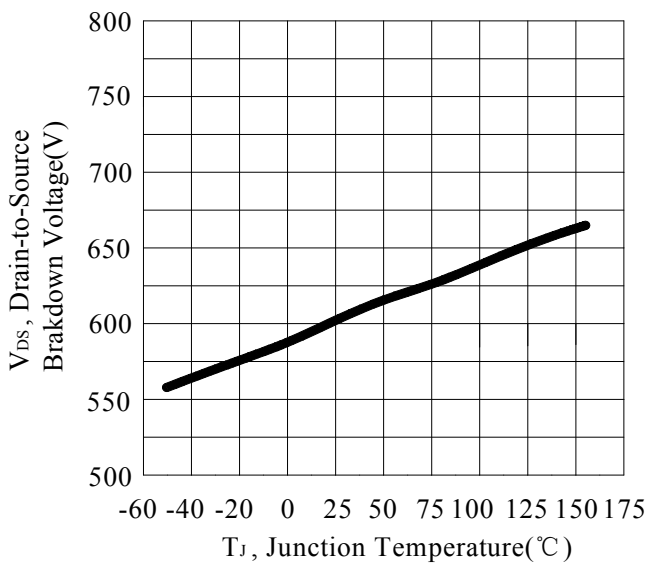
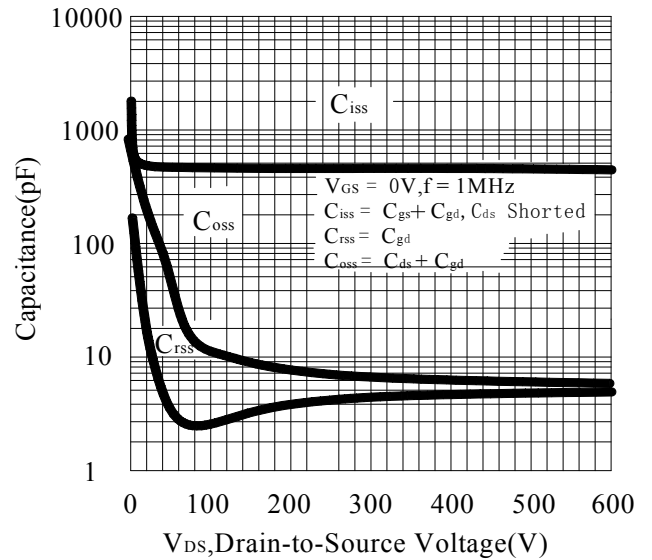
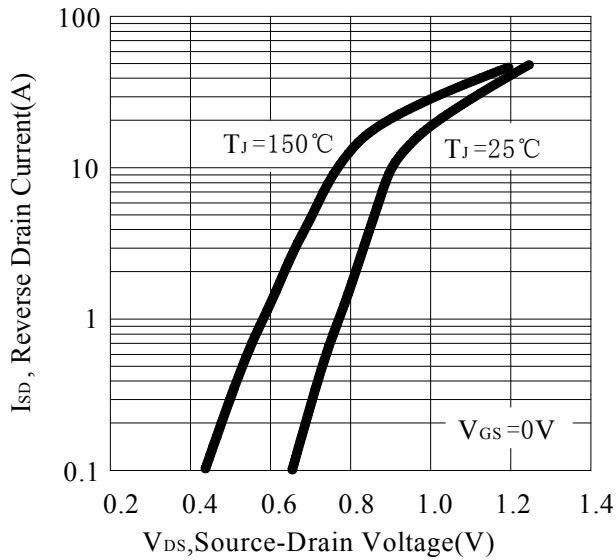
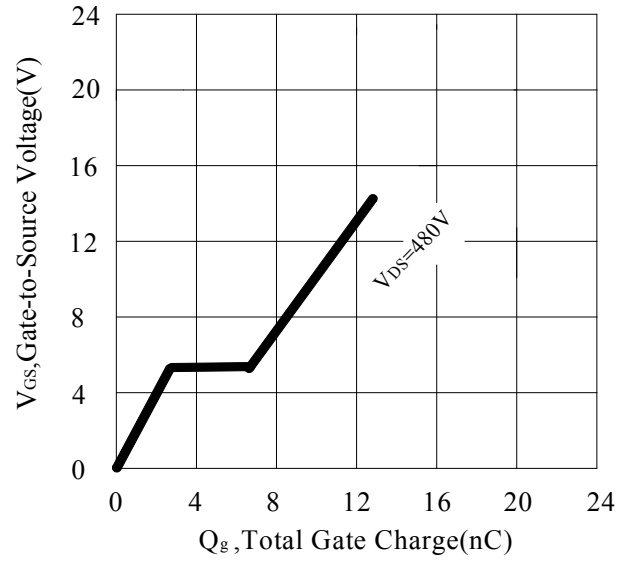
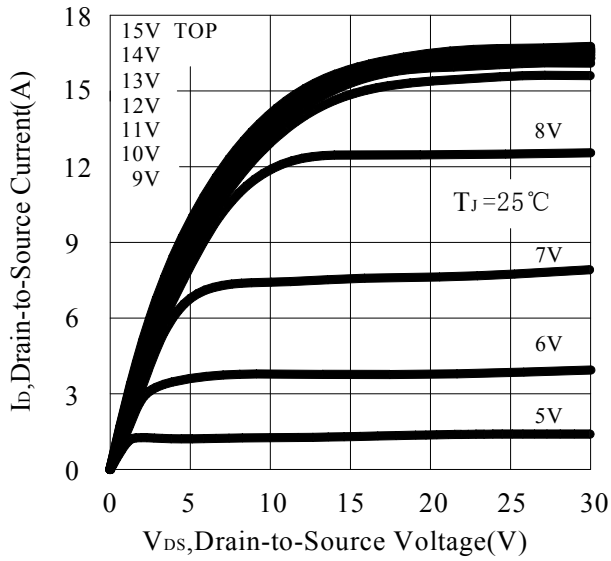

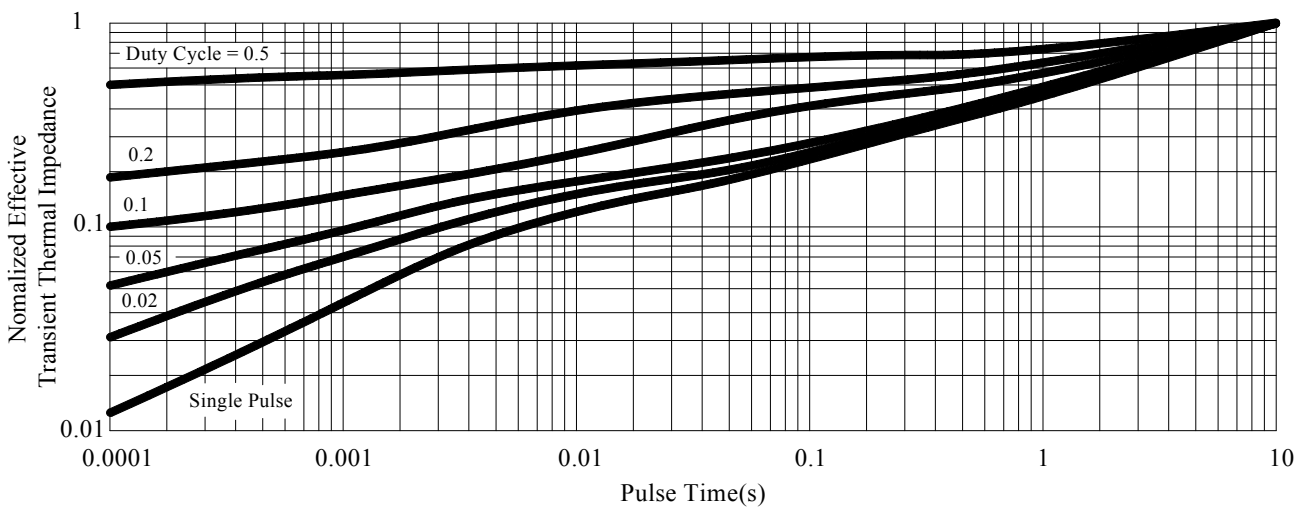
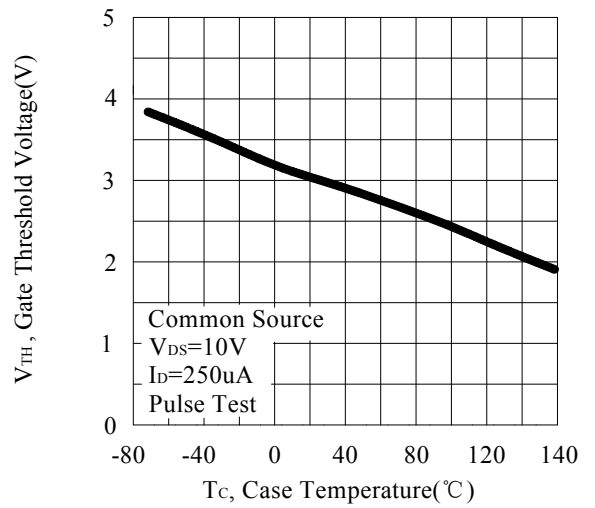
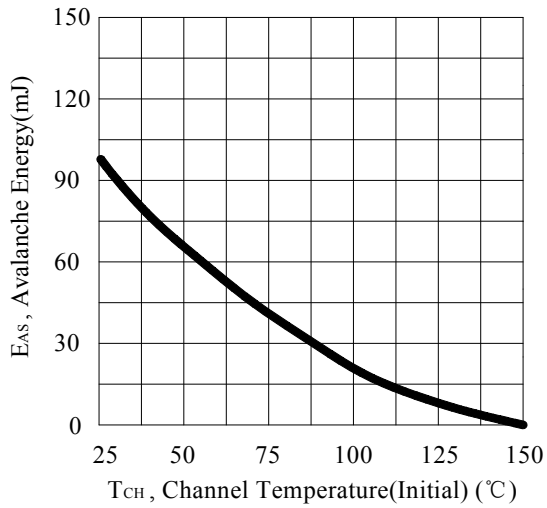
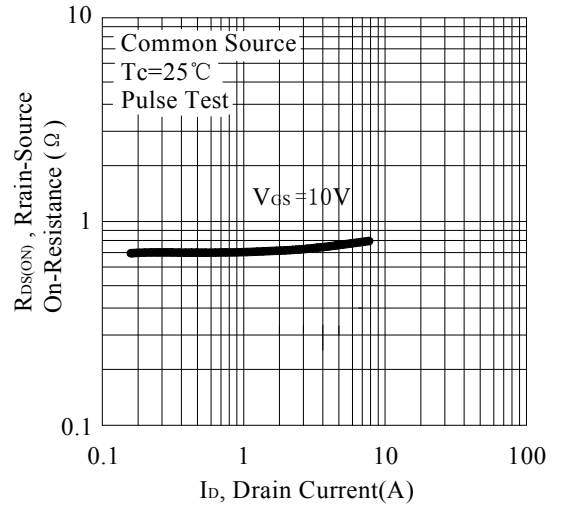
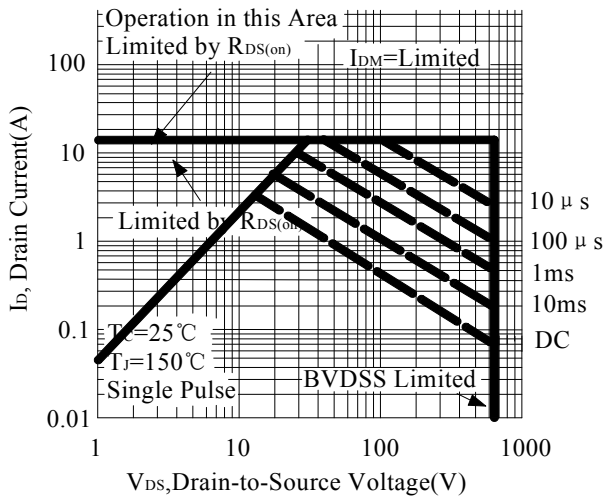

PACKAGE OUTLINE DIMENSIONS

TO-252

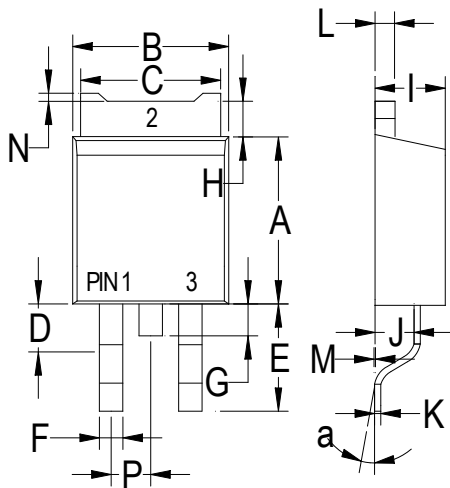

TO-252		
Dim	Min	Max
A	.230 (5.85)	.246 (6.25)
B	.250 (6.35)	.264 (6.75)
C	.207 (5.27)	.218 (5.54)
D	.037 (0.93)	.045 (1.14)
E	.106 (2.70)	.138 (3.50)
F	.028 (0.72)	.033 (0.84)
G	.024 (0.60)	.041 (1.05)
H	.028 (0.72)	.043 (1.10)
I	.085 (2.15)	.096 (2.45)
J	.037 (0.95)	.047 (1.20)
K	.018 (0.45)	.026 (0.65)
L	.018 (0.45)	.024 (0.60)
P	.081 (2.05)	.094 (2.40)
M	.000 (0.00)	.006 (0.15)
N	--	.008 (0.20)
a	0°	10°

Dimensions in inches and (millimeters)