

	<b>Cosemitech</b>	<b>CH463A/CH463AN</b>
	<b>Industry Product Group</b>	<small>This is advanced information on a new product now in development or undergoing evaluation. Details are subject to change without notice and Cosemitech assumes no obligation for future manufacture of this product. Contact Cosemitech for the latest status.</small>

**REV 1.1**

## FEATURES and FUNCTIONAL DIAGRAM

- Enhanced sensitivity: will operate from only 50 Gauss typical, at 25°C allowing the use of smaller, potentially lower-cost magnets or wider air gaps
- Subminiature, SOT-23-3L surface mount package (CH463AS/CH463ANS) supplied on tape and reel allows for a compact design with automated component placement, helping to reduce manufacturing costs
- Small, leaded, flat, TO-92S package (CH463AT/ CH463ANT) allows for a compact PCB layout
- Bipolar latching magnetics respond to alternating North and South poles, making these products well-suited for accurate speed sensing and RPM (revolutions per minute) measurement
- Wide operating voltage range of 3.5V to 30V makes these sensors useable in a wide range of applications
- Built-in inductance freewheeling diode, with the OUT terminal high voltage discharge capability enhances the protection of the sensor and the circuits with which it is used
- Robust design: will operate up to 150 °C
- RoHS-compliant material meets directive 2011/65/EU

Function Block Diagram

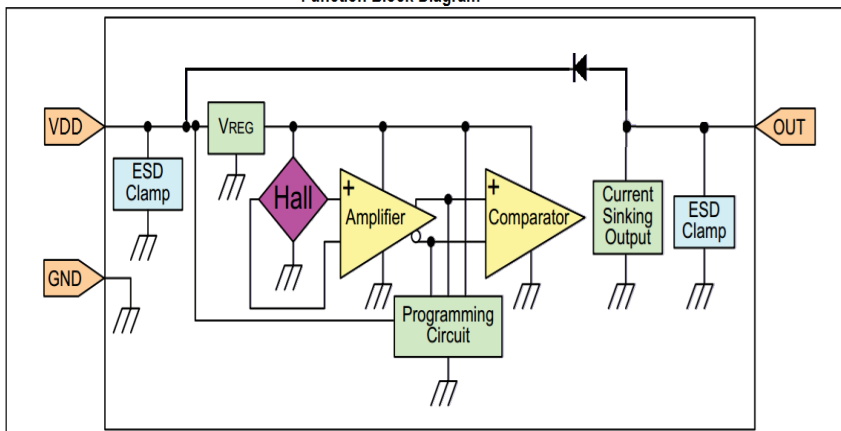

## PACKAGE

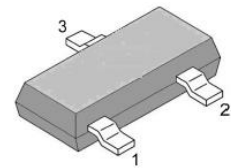

SOT-23 -3L

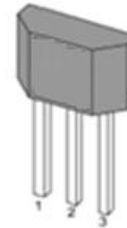

TO-92S

## APPLICATIONS

- Transportation
- Speed and RPM (revolutions per minute) sensing
  - Tachometer, counter pickup
  - Motor and fan control
  - Electric window lift
  - Convertible roof position
  - Automotive transmission position
- Industrial
- Speed and RPM sensing
  - Tachometer, counter pickup
  - Flow-rate sensing
  - Brushless dc (direct current) motor commutation
  - Motor and fan control
  - Robotics control
- Medical
- Motor assemblies
  - Medication dispense control

## DESCRIPTION

The CH463A and CH463AN are small, versatile digital Hall effect devices that are operated by the magnetic field from a permanent magnet or an electromagnet, designed to respond to alternating North and South poles.

These bipolar latching sensor ICs have enhanced sensitivity, which often allows for the use of less expensive magnets.

These sensor ICs are available in two package styles, the CH463AS/CH463ANS in the subminiature SOT-23-3L surface mount package and the CH463AT/ CH463ANT in the leaded, flat TO-92S package.

The CH463AS/CH463ANS's small size requires less PC board space, allowing it to be used in smaller assemblies. Its 3.5V capability allows for use in low voltage applications, promoting energy efficiency.

The CH463AS/CH463ANS is available on tape and reel; the CH463AT/ CH463ANT is available in a bulk package (1000 units per bag).

	<b>Cosemitech</b>	<b>CH463A/CH463AN</b>
	<b>Industry Product Group</b>	<small>This is advanced information on a new product now in development or undergoing evaluation. Details are subject to change without notice and Cosemitech assumes no obligation for future manufacture of this product. Contact Cosemitech for the latest status.</small>

**REV 1.1**

## Table of Contents

1. Product Family Members.....		3
2. Pin Definitions and Descriptions.....		3
3. Absolute Maximum Ratings.....		3
4. ESD Protections.....		4
5. Function Description.....		4
6. Definition of Switching Function.....		4
7. Temperature Characterization.....		4
8. Parameters Specification.....		5
9. Test Conditions.....		6
10. Typical Application Circuit.....		6
11. Typical Output Waveform.....		6
12. Package Information.....		7
13. Version History.....		9

**Cosemitech****CH463A/CH463AN****Industry Product Group**

This is advanced information on a new product now in development or undergoing evaluation. Details are subject to change without notice and Cosemitech assumes no obligation for future manufacture of this product. Contact Cosemitech for the latest status.

**REV 1.1****1. Product Family Members**

Part Number	Marking ID	Description
CH463ASR	463A	Bipolar latching, Hall-effect digital sensor IC, SOT-23-3L package, tape and reel packing (3000 units per reel)
CH463ATB	463A	Bipolar latching, Hall-effect digital sensor IC, flat, TO-92S package, bulk packing (1000 units per bag)
CH463ANSR	463AN	Bipolar latching, Hall-effect digital sensor IC, SOT-23-3L package, tape and reel packing (3000 units per reel)
CH463ANTB	463AN	Bipolar latching, Hall-effect digital sensor IC, flat, TO-92S package, bulk packing (1000 units per bag)

**2. Pin Definitions and Descriptions**

SOT-23-3L(S)	TO-92S(T)	Name	Type	Function
1	1	VDD	Supply	Supply Voltage pin
2	3	OUT	Output	Open Collector Output pin (include freewheeling diode)
3	2	GND	Ground	Ground pin

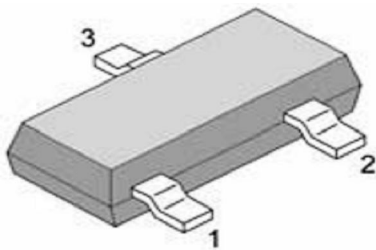
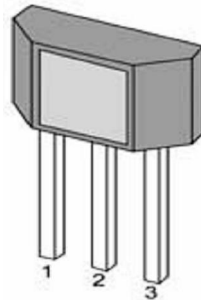
**SOT-23-3L****TO-92S****3. Absolute Maximum Ratings**

Parameter	Symbol	Min	Max	Units
Supply Voltage	$V_{DD}$	-	40	V
Reverse Voltage	$V_{RDD}$	-	-0.3	V
Supply Current	$I_{DD}$	-	20	mA
Output Voltage	$V_{OUT}$	-0.3	40	V
Output Current	$I_{OUT}$	-	20	mA
Operating Ambient Temperature	$T_A$	-40	150	°C
Storage Temperature	$T_S$	-50	150	°C
Junction temperature	$T_J$	-50	165	°C
Magnetic Flux	B	No Limit		Gauss

Note 1: Exceeding the absolute maximum ratings may cause permanent damage. Exposure to absolute-maximum- rated conditions for extended periods may affect device reliability.

Note 2: Based on the Voltage Surge Test result (Automotive electronics test standard: AEC-Q200-007 REV A), the device which under the test is able to withstand dynamic voltage reach about 70V (worst case), and the current ability is able to be 0.28A (worst case). Though the test result is not a guarantee value, but the test result is a strong robust indication for device dynamic breakdown voltage and current.

	<b>Cosemitech</b>	<b>CH463A/CH463AN</b>
	<b>Industry Product Group</b>	<small>This is advanced information on a new product now in development or undergoing evaluation. Details are subject to change without notice and Cosemitech assumes no obligation for future manufacture of this product. Contact Cosemitech for the latest status.</small>

**REV 1.1**

#### 4. ESD Protections

Parameter	Value	Unit
All pins <sup>1)</sup>	+/-4000	V
All pins <sup>2)</sup>	+/-400	V
All pins <sup>3)</sup>	+/-1500	V

1) HBM (human body mode, 100pF, 1.5 kohm ) according to MIL-STD-883H Method 3015.8

2) MM (Machine Mode C=200pF, R=0 $\hat{o}$ ) according to JEDEC EIA/JESD22-A115

3) CDM (charged device mode) according to JEDEC EIA/JESD22-C101F

#### 5. Function Description

The CH463A/CH463AN exhibits latch magnetic switching characteristics. Therefore, it requires both south and north poles to operate properly.

The device behaves as a latch with symmetric operating and release switching points (BOP=|BRP|). This means magnetic fields with equivalent strength and opposite direction drive the output high and low.

Removing the magnetic field (B = 0) keeps the output in its previous state. This latching property defines the device as a magnetic memory.

A magnetic hysteresis BHYST keeps BOP and BRP separated by a minimal value. This hysteresis prevents output oscillation near the switching point.

#### 6. Magnetic Activation

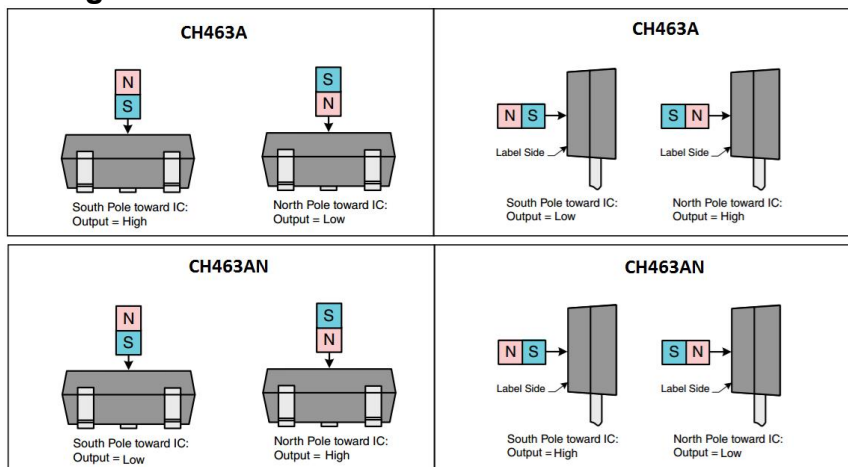

#### 7. Temperature Characteristics

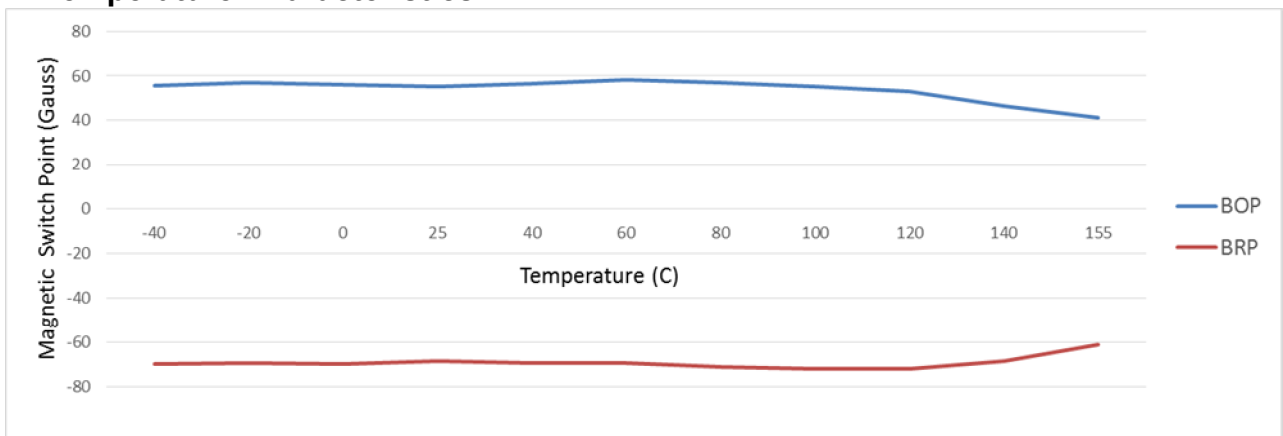

**Cosemitech****CH463A/CH463AN****Industry Product Group**

This is advanced information on a new product now in development or undergoing evaluation. Details are subject to change without notice and Cosemitech assumes no obligation for future manufacture of this product. Contact Cosemitech for the latest status.

**REV 1.1****8. Parameters Specification (At 3.5V to 30V supply, 20mA load, TA= -40 °C to 150 °C except where otherwise specified.)**

Symbol	Parameter	Test Condition	Min	Typ.	Max	Units
V <sub>DD</sub>	Supply voltage	-40 °C to 150 °C	3.5	-	30	V
I <sub>DD</sub>	Supply Current	V <sub>DD</sub> = 5V	-	5.0	10	mA
V <sub>DSon</sub>	Output saturation voltage	at 20mA, Gauss >120	-	-	0.4	V
I <sub>OFF</sub>	Output Leakage Current	B < -120GS	-	-	10	uA
T <sub>R</sub>	Output rise time	V <sub>DD</sub> = 12V at 25 °C C <sub>L</sub> = 20 pF	-	-	1.5	uS
T <sub>F</sub>	Output fall time	V <sub>DD</sub> = 12V at 25 °C C <sub>L</sub> = 20 pF	-	-	1.5	uS
R <sub>TH</sub>	Thermal resistance: CH463AS (SOT-23-3L) CH463AT (TO-92S)	-	- -	303 203	- -	°C /W °C/W
B <sub>OP</sub>	CH463A Magnetic operating point	-40°C to 150°C	5	45	95	Gauss
	CH463AN Magnetic operating point	-40°C to 150°C	-95	-45	-5	Gauss
B <sub>RP</sub>	CH463A Magnetic release point	-40°C to 150°C	-95	-45	-5	Gauss
	CH463AN Magnetic release point	-40°C to 150°C	5	45	95	Gauss
B <sub>HYST</sub>	CH463A Magnetic hysteresis window	T <sub>A</sub> =25°C  B <sub>OP</sub> -B <sub>RP</sub>	60	90	120	Gauss
	CH463AN Magnetic hysteresis window	T <sub>A</sub> =25°C  B <sub>OP</sub> -B <sub>RP</sub>	60	90	120	Gauss
F <sub>SW</sub>	Maximum Switching Frequency				100	KHz
T	Operating temperature		-40	-	150	°C
T <sub>S</sub>	Storage temperature:	-	-40	-	150	°C

**NOTICE**

Bipolar Hall-effect sensor ICs may have an initial output in either the ON or OFF state if powered up with an applied magnetic field in the differential zone (applied magnetic field >B<sub>RP</sub> and <B<sub>OP</sub>). Cosemitech recommends allowing 10 μs for output voltage to stabilize after supply voltage has reached 5V.

**NOTICE**

The magnetic field strength (Gauss) required to cause the switch to change state (operate and release) will be as specified in the magnetic characteristics. To test the switch against the specified magnetic characteristics, the switch must be placed in a uniform magnetic field.

	<b>Cosemitech</b>	<b>CH463A/CH463AN</b>
	<b>Industry Product Group</b>	This is advanced information on a new product now in development or undergoing evaluation. Details are subject to change without notice and Cosemitech assumes no obligation for future manufacture of this product. Contact Cosemitech for the latest status.

**REV 1.1**

## 9. Test Conditions

Note: DUT=Device Under Test

### Supply Current

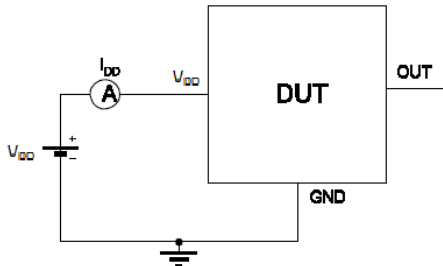

Note 1 - The supply current  $I_{DD}$  represents the static supply current. OUT is left open during measurement

Note 2 - The device is put under magnetic field with  $B < B_{RP}$

### Output Saturation Voltage

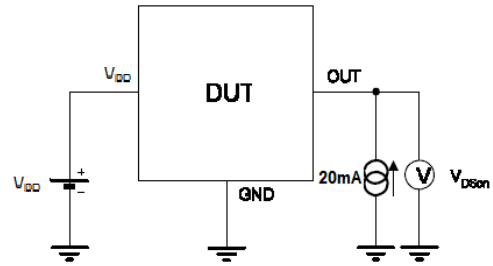

Note 1 - The output saturation voltage  $V_{DS(on)}$  is measured at  $V_{DD}=3.8V$  and  $V_{DD}=24V$

Note 2 - The device is put under magnetic field with  $B > B_{OP}$

### Output Leakage Current

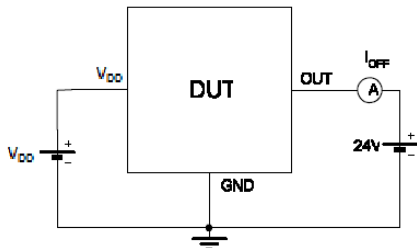

Note 1 - The device is put under magnetic field with  $B < B_{RP}$

### Magenetic Thresholds

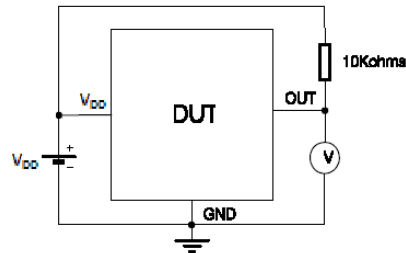

Note 1 -  $B_{OP}$  is determined by putting the device under magnetic field swept from  $B_{RPmin}$  up to  $B_{OPmax}$  until the output is switched on.

Note 2 -  $B_{RP}$  is determined by putting the device under magnetic field swept from  $B_{OPmax}$  down to  $B_{RPmin}$  until the output is switched off.

## 10. Typical Application Circuit

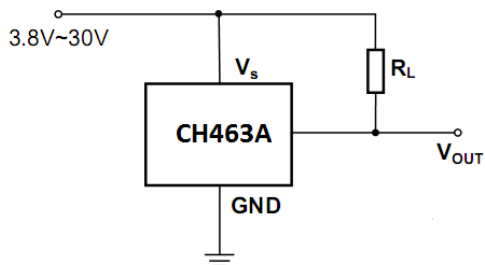

## 11. Typical Output Waveform (The TO-92S package as an example )

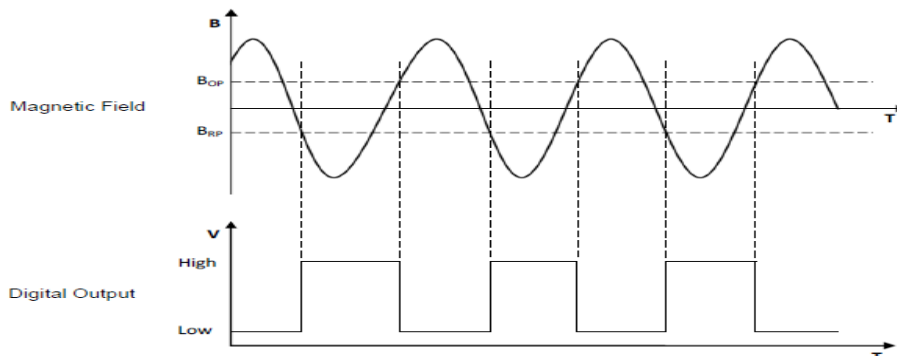

**12. Package Information:**  
**PACKAGE DESIGNATOR**  
**TO-92S (CH462T)**

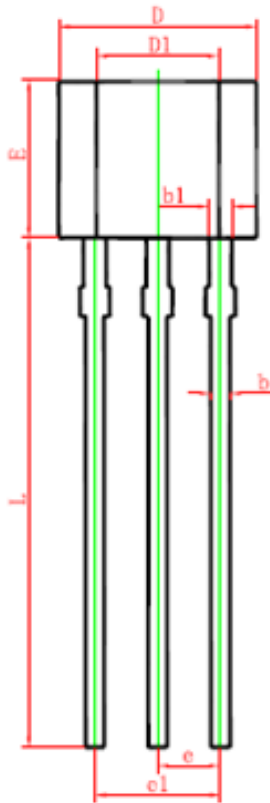
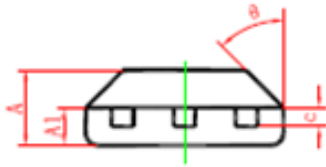

Symbol	Dimensions In Millimeters		Dimensions In Inches	
	Min.	Max.	Min.	Max.
A	1.420	1.620	0.056	0.064
A1	0.660	0.860	0.026	0.034
b	0.350	0.480	0.014	0.019
b1	0.400	0.550	0.016	0.022
c	0.360	0.510	0.014	0.020
D	3.900	4.100	0.154	0.161
D1	2.280	2.680	0.090	0.106
E	3.050	3.250	0.120	0.128
e	1.270 TYP.		0.050 TYP.	
e1	2.440	2.640	0.096	0.104
L	15.100	15.500	0.594	0.610
θ	45° TYP.		45° TYP.	



Cosemitech

CH463A/CH463AN

Industry Product Group

This is advanced information on a new product now in development or undergoing evaluation. Details are subject to change without notice and Cosemitech assumes no obligation for future manufacture of this product. Contact Cosemitech for the latest status.

REV 1.1

PACKAGE DESIGNATOR  
SOT-23-3L (CH462S)

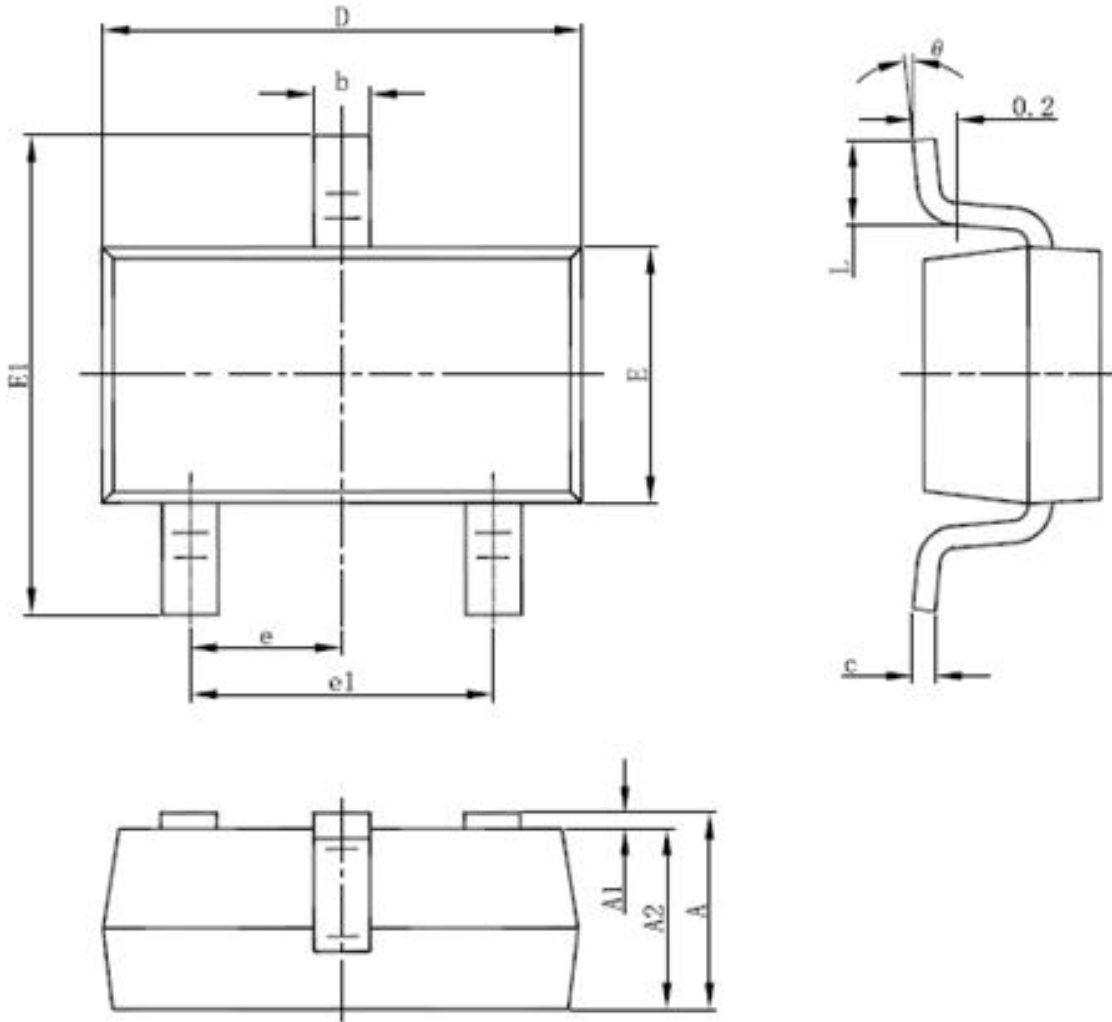





**Cosemitech**

**CH463A/CH463AN**

**Industry Product Group**

This is advanced information on a new product now in development or undergoing evaluation. Details are subject to change without notice and Cosemitech assumes no obligation for future manufacture of this product. Contact Cosemitech for the latest status.

**REV 1.1**

Symbol	Dimensions In Millimeters		Dimensions In Inches	
	Min	Max	Min	Max
A	1.050	1.250	0.041	0.049
A1	0.000	0.100	0.000	0.004
A2	1.050	1.150	0.041	0.045
b	0.300	0.500	0.012	0.020
c	0.100	0.200	0.004	0.008
D	2.820	3.020	0.111	0.119
E	1.500	1.700	0.059	0.067
E1	2.650	2.950	0.104	0.116
e	0.950(BSC)		0.037(BSC)	
e1	1.800	2.000	0.071	0.079
L	0.300	0.600	0.012	0.024
$\theta$	0°	8°	0°	8°

Information furnished is believed to be accurate and reliable. However, Cosemitech assumes no responsibility for the consequences of use of such information nor for any infringement of patents or other rights of third parties which may result from its use. No license is granted by implication or otherwise under any patent or patent rights of Cosemitech. Specification mentioned in this publication are subject to change without notice. This publication supersedes and replaces all information previously supplied. Cosemitech products are not authorized for use as critical components in life support devices or systems without express written approval of Cosemitech.

The Cosemitech logo is a registered trademark of Cosemitech