

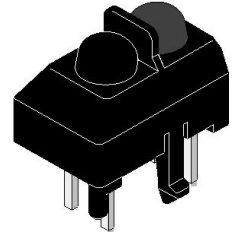

ZOS-R1006-07(ZD) Reflective Optical Sensor with Transistor Output



Descriptions

The ZOS-R1006-07(ZD) is a photointerrupter high-performance standard type, combines high-output GaAIAs IRED with high sensitive phototransistor.

Features

- Fast response time
- Snap-in construction for PCB mounting
- High sensitivity
- RoHS Compliance

Applications

- Printers
- FAX
- Copiers
- Scanners
- Amusement machines



Package Dimension

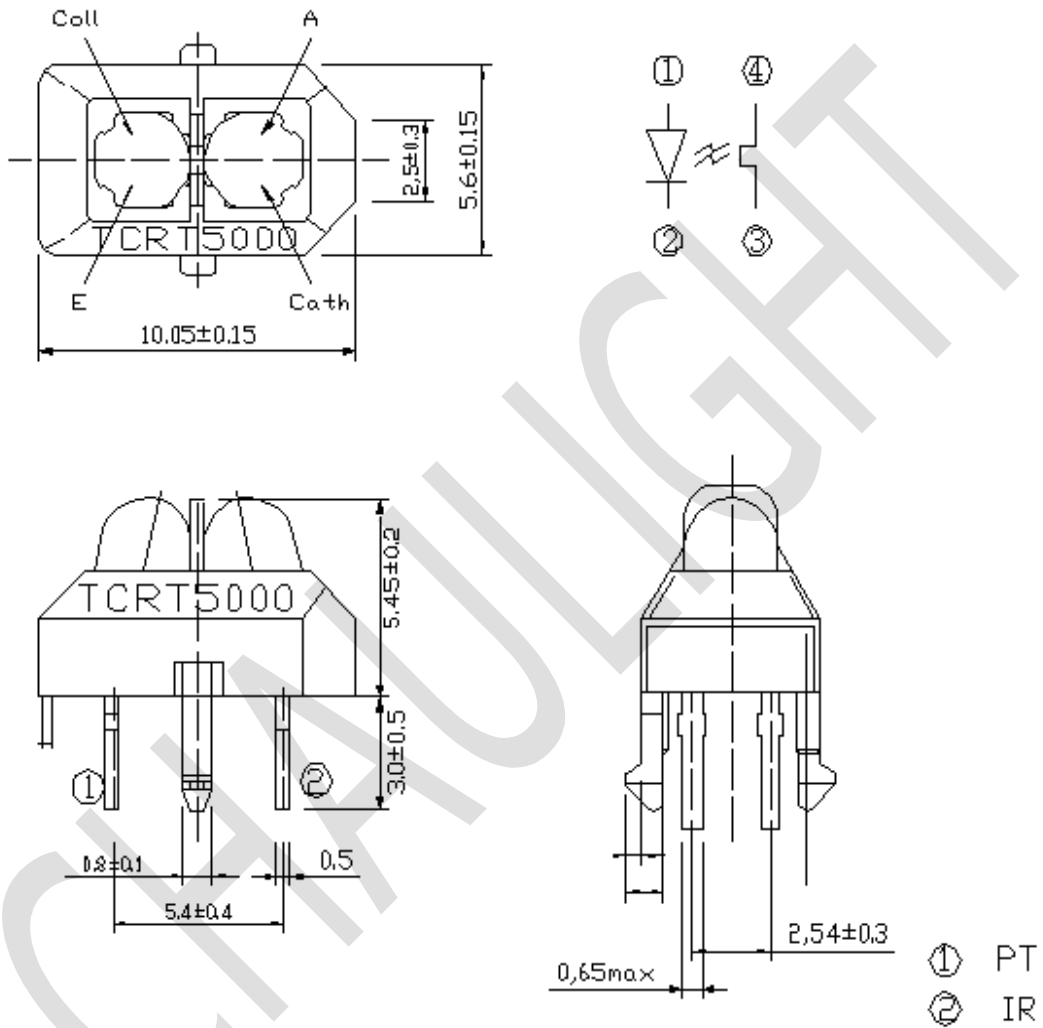



Absolute Maximum Ratings

Parameter (Ta=25°C)		Symbo	Ratings	Unit
Input (Emitter)	Power Dissipation at(or below) 25 Free Air Temperature	Pd	75	mW
	Reverse Voltage	V _R	5	V
	Forward Current	I _F	50	mA
	Peak Forward Current Pulse width≤100μs,Duty cycle= 1%	I _{FP}	1	A
Output (Detector)	Collector Power Dissipation	P _C	75	mW
	Collector Current	I _C	20	mA
	Collector-Emitter Voltage	V _{CEO}	30	V
	Emitter-Collector Voltage	V _{ECCO}	5	V
Operating Temperature		T _{opr}	-25~+85	°C
Storage Temperature		T _{stg}	-40~+85	°C
Lead Soldering Temperature (2mm form body for 5 seconds)		T _{sol}	260	°C

Electro-Optical Characteristics

Parameter (Ta=25°C)		Symbo	Min.	Typ.	Max.	Unit	Conditions
Input (Emitter)	Forward Voltage	V _F	--	1.2	1.5	V	I _F =20mA
	Reverse Current	I _R	--	--	10	μA	V _R =5V
	Peak Wavelength	λ _p	--	940	--	nm	I _F =20mA
Output (Detector)	Dark C urrent	I _{CEO}	--	--	100	nA	V _{CE} =20V E _e =0mW/cm ²
	C-E Saturation Voltage	V _{CE(sat)}	--	--	0.4	V	I _C =2mA E _e =1mW/cm ²
Transfer Characteristics	Collect Current	I _{C(ON)}	0.1	--	--	mA	V _{CE} =5V I _F =20mA
	Rise time	t _r	--	15	--	μs	V _{CE} =5V I _C =1mA R _L =1KΩ
	Fall time	t _f	--	15	--	μs	V _{CE} =5V I _C =1mA R _L =1KΩ



Typical Electrical/Optical/Characteristics Curves

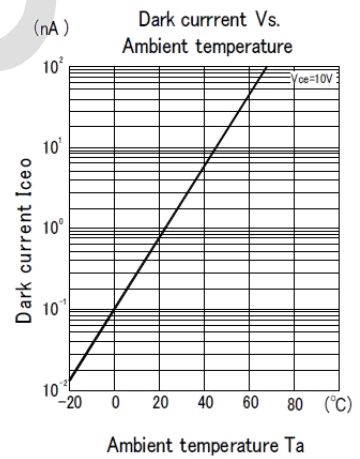
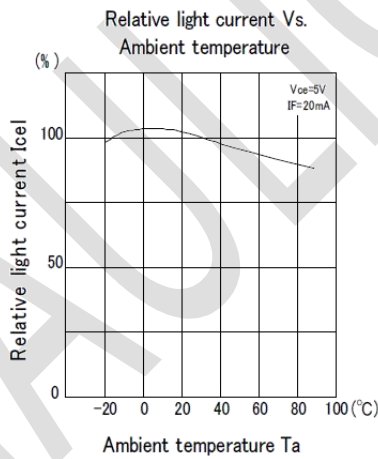
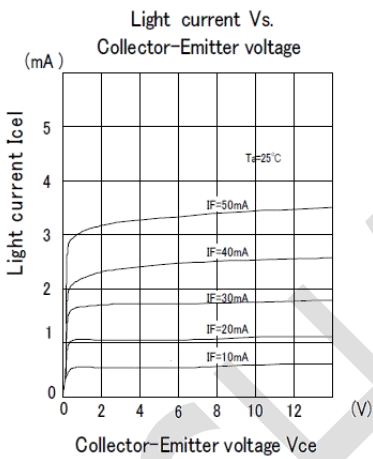
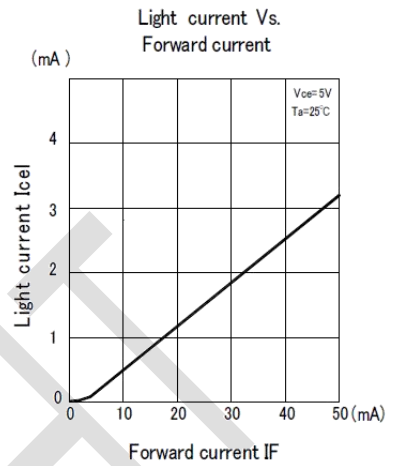
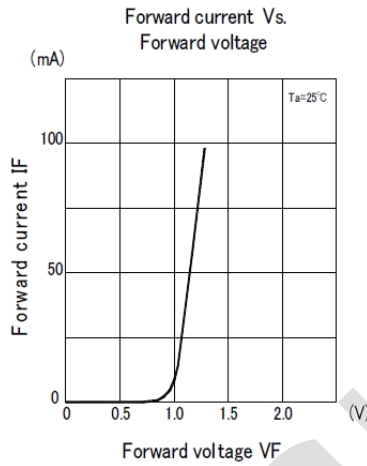
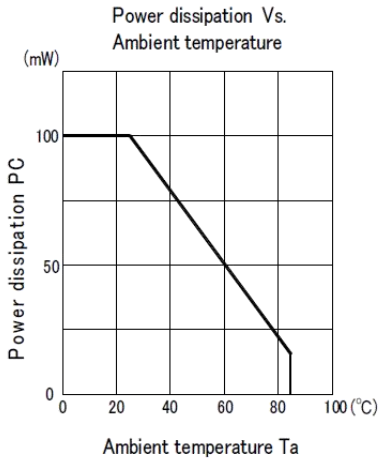



Packing Quantity Specification

1. 400PCS/1Bags, 5Bags/1Box
2. 10Boxes/1Carton

Notes

1. Above specification may be changed without notice. JUNHAO will reserve authority on material change for above specification.
2. When using this product, please observe the absolute maximum ratings and the instruction for using outlined in these specification sheets. JUNHAO assumes no responsibility for any damage resulting from use of the product which does not comply with the absolute maximum ratings and the instructions included in these specification sheets.
3. These specification sheets include materials protected under copyright of JUNHAO corporation. Please don't reproduce or cause anyone to reproduce them without JUNHAO's consent.