

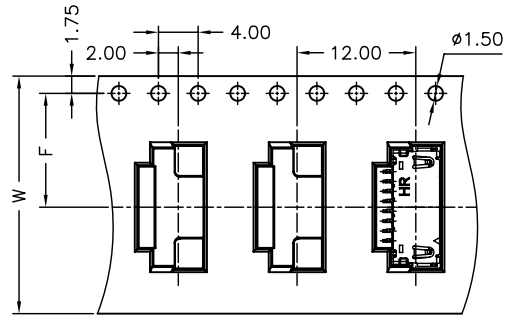

08 contacts

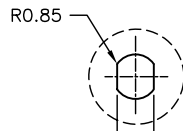

Unreeling direction →

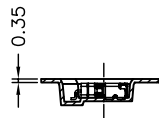

1.50^{+0.10}

14~30 contacts

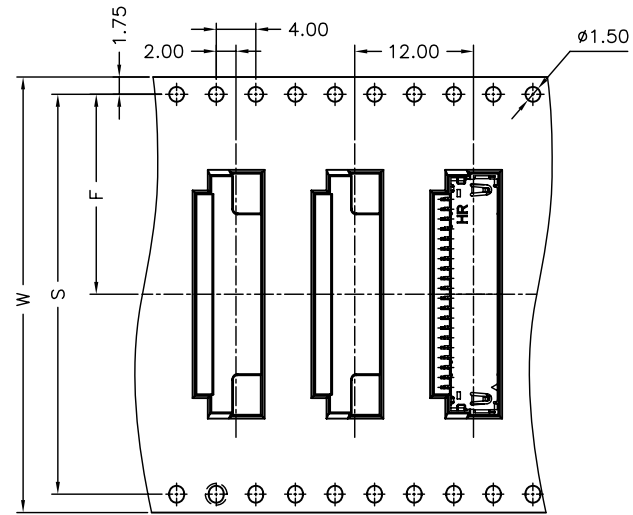

Unreeling direction →

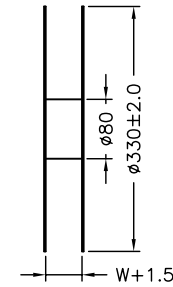
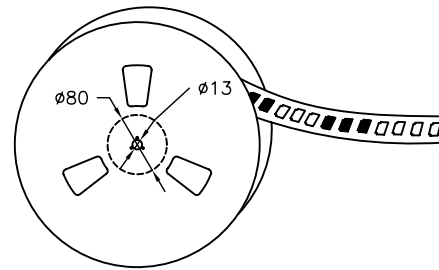
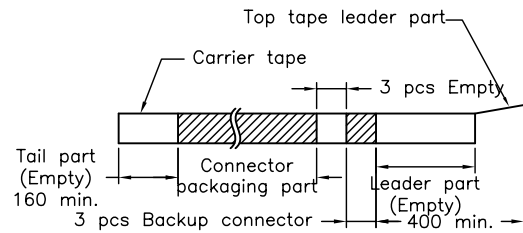

Number of Contacts	W±0.3	F±0.1	S±0.1	Q'ty/Reel
08P	24	11.50	28.40	2,000
14P	32	14.20	40.40	2,000
20P	44	20.20	52.40	2,000
30P	56	26.20		2,000

				燦達電子工業股份有限公司 JOINT TECH ELECTRONIC IND. CO., LTD.	
UNIT		SCALE	SHEET		TITLE:
mm		1 : 1	2 of 2		1.00mm PITCH 90° WAFER-SMT TYPE TAPING SPEC.
DRAWN BY		APPROVED BY		DRAW NO. : A1007WR-S-XP	
歐陽小強		謝瑞清			
2008.09.17		2008.09.17			
				GENERAL TOLERANCE	
B5	EN1705150001	2017.05.15	周傑亮	X. X±0.25	ANGLE±
B4	EN1504150001	2015.04.15	黃模有	X. XX±0.15	
B3	EN1209030291	2012.11.14	陳錦展	X. XXX±0.05	
B2	EN1203230081	2012.05.04	楊峰		
REV.	DESCRIPTION	DATE	NAME		