

## BT137

双向可控硅  
TRIAC

版本号  
201603-A

### 产品概述 GENERAL DESCRIPTION

BT137 双向可控硅采用穿通隔离台面结构，复合玻璃钝化PN结表面保护工艺技术，dv/dt高，可靠性高，适用于控温、调光、马达控制。

BT137 Triacs is fabricated using separation diffusion processes ,the junction termination areas are passivated with glass. Thanks to highly dv/dt and reliability,the Triacs series is suitable for domestic lighting ,heating and motor speed controllers.

### 主要参数 MAIN CHARACTERISTICS

参数 Parameter	数值 Value	单位 Unit
$I_{T(RMS)}$	8	A
$V_{DRM}/V_{RRM}$	600&800	V
$I_{GT(III)}$	$\leq 10$	mA

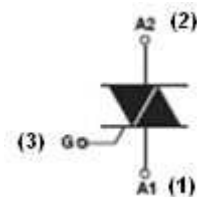

### 产品特性

### FEATURES

- dv/dt高
- 通态压降低
- Rohs环保产品
- Highly dv/dt
- Low on-state voltage
- Rohs Products

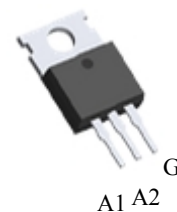

TO-220D

### 应用领域 APPLICATIONS

主要应用于调光、控温、马达控制。

domestic lighting ,heating and motor speed controllers.

## 极限值(除非另有规定, T<sub>j</sub>=25℃) ABSOLUTE RATINGS

(T<sub>j</sub>=25℃, unless otherwise specified)

符号 Symbol	参数 Parameter	数值 Value	单位 Unit
I <sub>T(RMS)</sub>	RMS 通态电流 RMS on-state current (full sine wave)	T <sub>C</sub> =102℃ 8	A
I <sub>TSM</sub>	通态峰值浪涌电流 Non repetitive surge peak on-state current	F=50Hz, t=20ms 60	A
I <sup>2</sup> t	I <sup>2</sup> t 耗散值 I <sup>2</sup> t value for fusing	T <sub>p</sub> =10ms 21	A <sup>2</sup> s
di/dt	通态电流上升值 Critical rate of rise of on-state current	F=120Hz, T <sub>j</sub> =125℃ 50	A/μs
I <sub>GM</sub>	门极峰值电流 Peak gate current	T <sub>p</sub> =20μs, T <sub>j</sub> =125℃ 2	A
P <sub>G(AV)</sub>	平均门极耗散功率 Average gate power dissipation	T <sub>j</sub> =125℃ 0.5	W
T <sub>stg</sub>	贮存结温范围 Storage junction temperature range	-40~+150	℃
T <sub>j</sub>	工作结温范围 Operating junction temperature range	-40~+125	℃

## 电参数(除非另有规定, T<sub>j</sub>=25℃) ELECTRICAL CHARACTERISTICS

(T<sub>j</sub>=25℃, unless otherwise specified)

参数 Parameter	符号 Symbol	规范值 Value		单位 Unit	测试条件 Test Conditions
		D	E		
触发电流 Gate trigger current	I <sub>GT</sub>	I ~ III	≤5	≤10	mA V <sub>D</sub> =12V, I <sub>T</sub> =0.1A
		IV	≤10	≤25	
触发电压 Gate trigger voltage	V <sub>GT</sub>	I ~ IV	≤1.5		V V <sub>D</sub> =12V, I <sub>T</sub> =0.1A
维持电流 Holding current	I <sub>H</sub>	≤20	≤30	mA	V <sub>D</sub> =12V, I <sub>T</sub> =0.1A
擎住电流 Latching current	I <sub>L</sub>	≤30	≤35	mA	V <sub>D</sub> =12V, I <sub>T</sub> =0.1A
电压上升率 Rise of off-state voltage	dv/dt	≥20	≥50	V/μS	V <sub>D</sub> =67%V <sub>DRM</sub>
通态压降 Peak on-state voltage	V <sub>TM</sub>	≤1.65		V	I <sub>T</sub> =10A
断态漏电流 Peak repetitive forward blocking current	I <sub>DRM</sub>	≤10		μA	V <sub>RRM</sub> =V <sub>DRM</sub> , T <sub>j</sub> =25℃
	I <sub>RRM</sub>	≤0.5		mA	V <sub>RRM</sub> =V <sub>DRM</sub> , T <sub>j</sub> =125℃

## 热特性 THERMAL RESISTANCES

符号 Symbol	参数 Parameter	数值 Value	单位 Unit
R <sub>th(j-c)</sub>	Junction to case(AC)	1.6	℃/W
R <sub>th(j-a)</sub>	Junction to ambient	60	℃/W

## 特征曲线 ELECTRICAL CHARACTERISTICS (CURVES)

图1 最大耗散功率与RMS通态电流关系

Fig.1.Maximum Power Dissipation Versus on-state current



图3 通态特性

Fig.3.On-State Characteristics

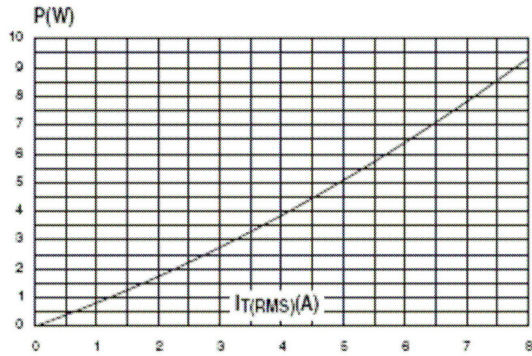

图2 RMS通态电流与Tc温度关系

Fig.2. RMS On-state Current Versus TL

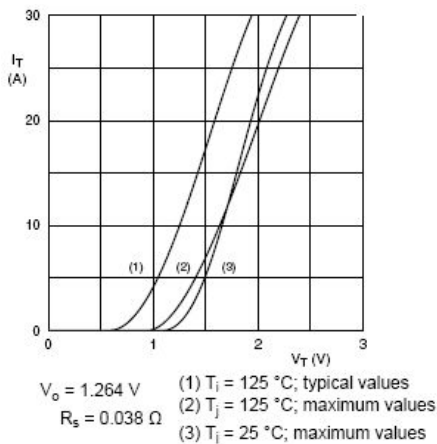

图4 通态浪涌峰值电流与周期数关系

Fig.4.Surge Peak On-state Current Versus Number Cycles

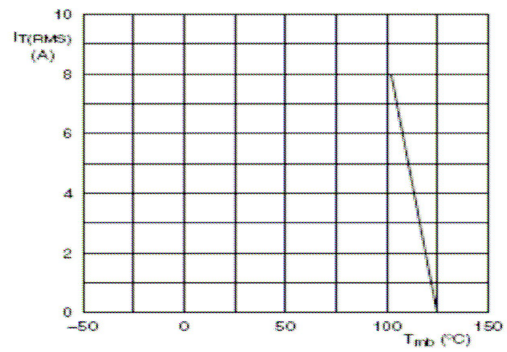

图5 IGT、IH、IL相对值（相对于25°C）与结温关系

Fig.5.Relative Variation Of Gate Trigger Current , Holding Current And Latching Current Versus Junction Temperature (Typical Value)

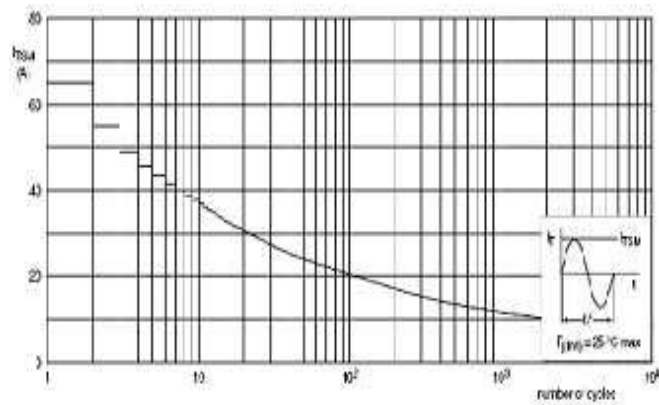
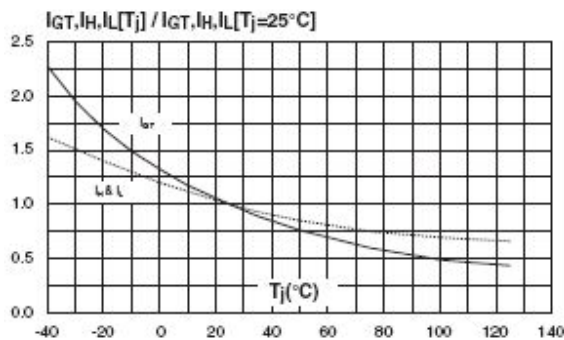

封装尺寸 PACKAGE MECHANICAL DATA

TO-220D

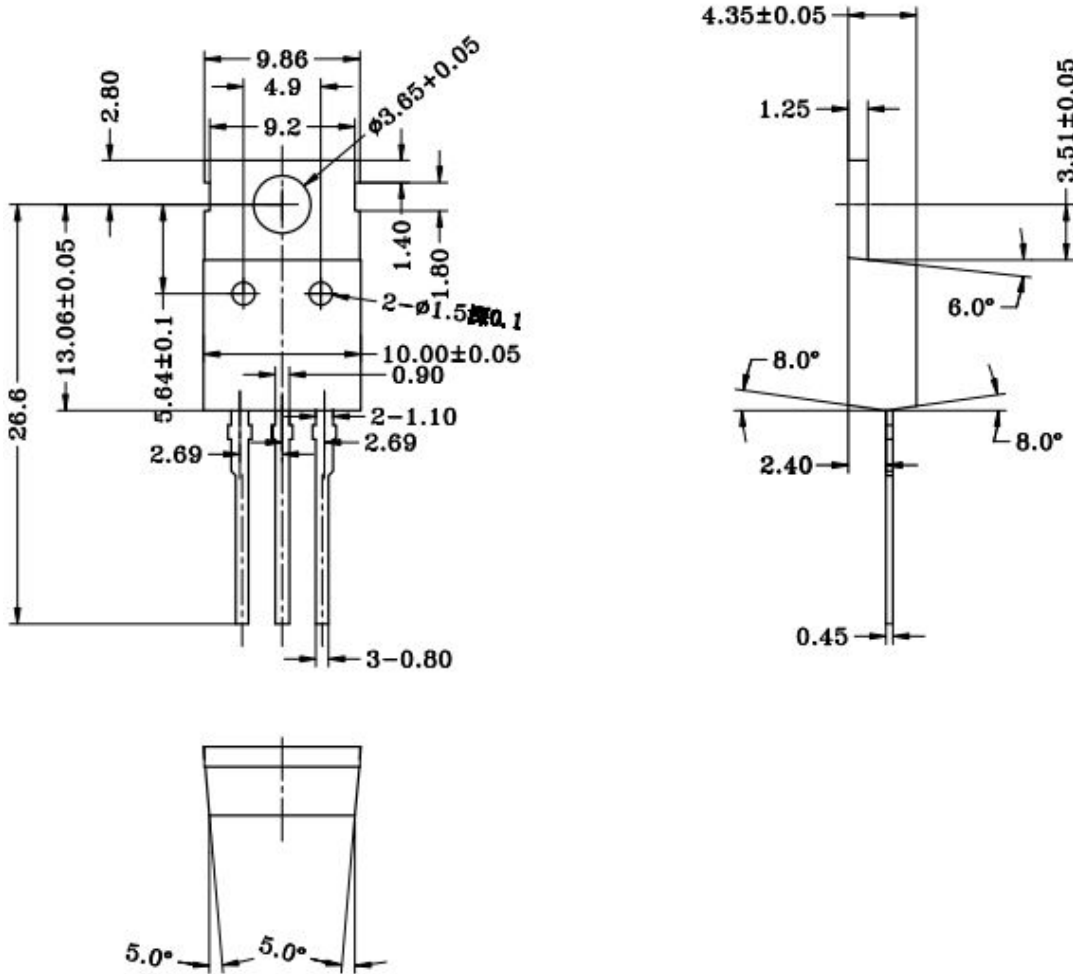

Information furnished is believed to be accurate and reliable. However, Jiangsu Dongchen Electronics Technology CO.,LTD assumes no responsibility for the consequences of use of such information nor for any infringement of patents or other rights of third parties which may result from its use. No license is granted by implication or otherwise under any patent or patent rights of Jiangsu Dongchen Electronics Technology CO.,LTD. Specifications mentioned in this publication are subject to change without notice. This publication supersedes and replaces all information previously supplied. Jiangsu Dongchen Electronics Technology CO.,LTD products are not authorized for use as critical components in life support devices or systems without express written approval of Jiangsu Dongchen Electronics Technology CO.,LTD.