

## 1A Low Dropout Positive Adjustable or Fixed-Mode Regulator KMA1117(LMA1117)

### ■ Features

- 1.4V maximum dropout at full load current
- Fast transient response
- Output current limiting
- Built-in thermal shutdown
- Good noise rejection
- 3-Terminal Adjustable or Fixed 1.5V, 1.8V, 1.9V, 2.5V, 3.3V, 5.0V

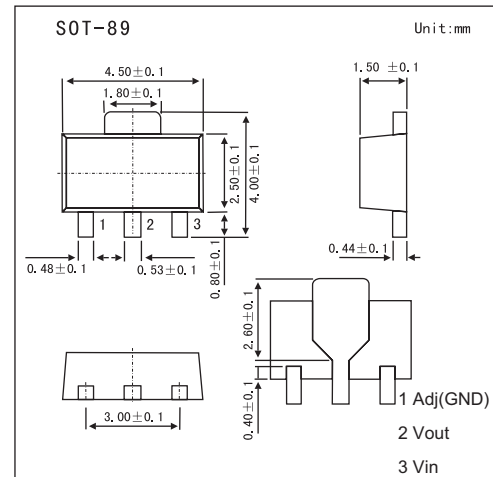

### ■ Absolute Maximum Ratings Ta = 25°C

Parameter	Symbol	Rating	Unit
DC Supply Voltage	V <sub>in</sub>	-0.3 to 12	V
Power Dissipation	P <sub>D</sub>	Internally Limited	
Thermal Resistance Junction-to-Ambient	θ <sub>JA</sub>	300	°C/W
Thermal Resistance Junction-to-Case *	θ <sub>JC</sub>	100	°C/W
Operating Junction Temperature Range	T <sub>OP</sub>	0 to +150	°C
Storage Temperature	T <sub>ST</sub>	-65 to +150	°C

\* Control Circuitry/Power Transistor

### ■ Block Diagram

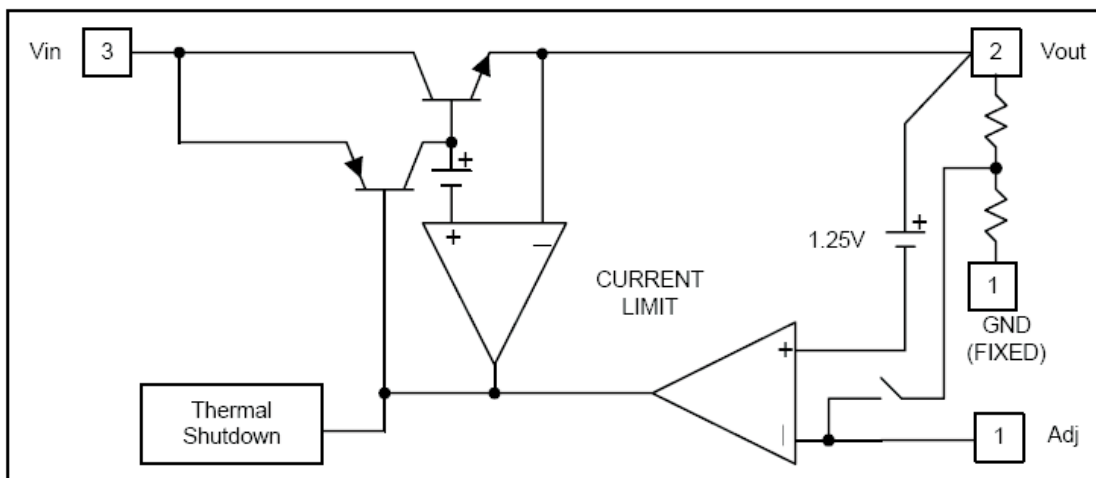

**KMA1117(LMA1117)**■ Electrical Characteristics  $T_a = 25^\circ\text{C}$ 

Parameter		Testconditons	Min	Typ	Max	Unit
Reference Voltage	KMA1117-ADJ	$T_J=25^\circ\text{C}, (V_{IN}-V_{OUT})=1.5\text{V}, I_o=10\text{mA}$	1.225	1.250	1.275	V
Output Voltage	KMA1117-1.5	$I_{OUT} = 10\text{mA}, T_J = 25^\circ\text{C}, 3\text{V} \leq V_{IN} \leq 12\text{V}$	1.470	1.500	1.530	V
	KMA1117-1.8	$I_{OUT} = 10\text{mA}, T_J = 25^\circ\text{C}, 3.3\text{V} \leq V_{IN} \leq 12\text{V}$	1.764	1.800	1.836	V
	KMA1117-1.9	$I_{OUT} = 10\text{mA}, T_J = 25^\circ\text{C}, 3.3\text{V} \leq V_{IN} \leq 12\text{V}$	1.862	1.900	1.938	V
	KMA1117-2.5	$I_{OUT} = 10\text{mA}, T_J = 25^\circ\text{C}, 4\text{V} \leq V_{IN} \leq 12\text{V}$	2.450	2.500	2.550	V
	KMA1117-3.3	$I_{OUT} = 10\text{mA}, T_J = 25^\circ\text{C}, 4.8\text{V} \leq V_{IN} \leq 12\text{V}$	3.235	3.300	3.365	V
	KMA1117-5.0	$I_{OUT} = 10\text{mA}, T_J = 25^\circ\text{C}, 6.5\text{V} \leq V_{IN} \leq 12\text{V}$	4.900	5.000	5.100	V
Line Regulation	KMA1117-XXX	$I_o=10\text{mA}, V_{OUT}+1.5\text{V} < V_{IN} < 12\text{V}, T_J=25^\circ\text{C}$			0.2	%
Load Regulation	KMA1117-ADJ	$V_{IN}=3.3\text{V}, V_{adj}=0, 0\text{mA} < I_o < 1\text{A}, T_J=25^\circ\text{C}$			1	%
	KMA1117-1.5	$V_{IN}=3\text{V}, 0\text{mA} < I_o < 1\text{A}, T_J=25^\circ\text{C}$		12	15	mV
	KMA1117-1.8	$V_{IN}=3.3\text{V}, 0\text{mA} < I_o < 1\text{A}, T_J=25^\circ\text{C}$		15	18	mV
	KMA1117-1.9	$V_{IN}=3.3\text{V}, 0\text{mA} < I_o < 1\text{A}, T_J=25^\circ\text{C}$		16	19	mV
	KMA1117-2.5	$V_{IN}=4\text{V}, 0\text{mA} < I_o < 1\text{A}, T_J=25^\circ\text{C}$		20	25	mV
	KMA1117-3.3	$V_{IN}=5\text{V}, 0\text{mA} < I_o < 1\text{A}, T_J=25^\circ\text{C}$		26	33	mV
	KMA1117-5.0	$V_{IN}=8\text{V}, 0\text{mA} < I_o < 1\text{A}, T_J=25^\circ\text{C}$		40	50	mV
Dropout Voltage ( $V_{IN}-V_{OUT}$ )	KMA1117-XXX	$I_{OUT} = 1\text{A}, \Delta V_{OUT}=0.1\%V_{OUT}$		1.3	1.4	V
Current Limit	KMA1117-XXX	$(V_{IN}-V_{OUT}) = 5\text{V}$	1.1			A
Minimum Load Current	KMA1117-XXX	$0^\circ\text{C} \leq T_J \leq 125^\circ\text{C}$		5	10	mA
Thermal Regulation		$T_a=25^\circ\text{C}, 30\text{ms pulse}$		0.008	0.04	%/W
Ripple Rejection		$F=120\text{Hz}, C_{OUT}=25\mu\text{F Tantalum}, I_{OUT}=1\text{A}$				
	KMA1117-XXX	$V_{IN}=V_{OUT}+3\text{V}$		60	70	dB
Temperature Stability		$I_o=10\text{mA}$		0.5		%

### KMA1117(LMA1117)

■ Typical Characteristics

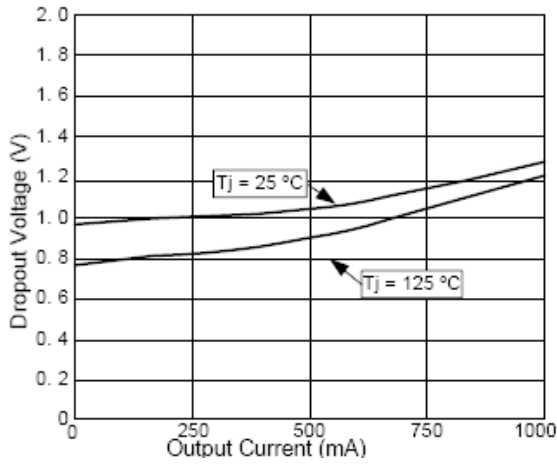

Fig.1 Dropout Voltage vs Output Current

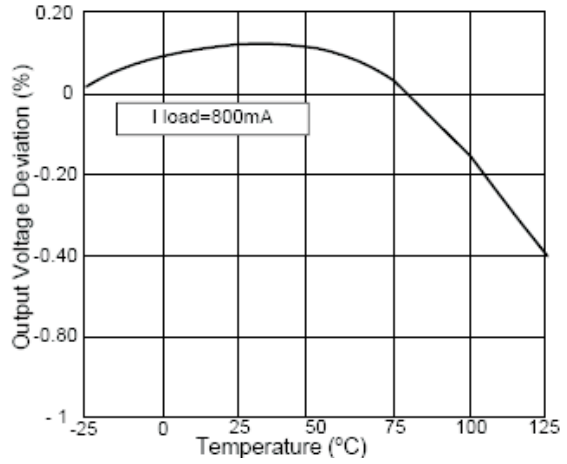

Fig.2 Load Regulation vs Temperature

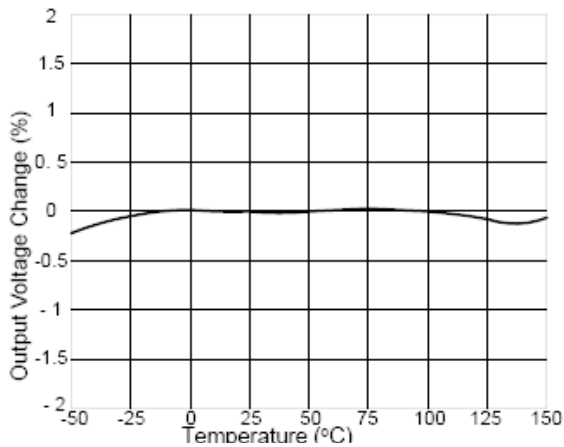

Fig.3 Percent Change in Output Voltage vs Temperature

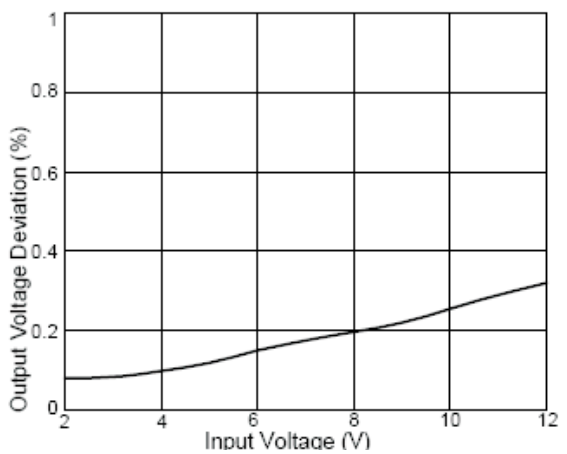

Fig.4 Line Regulation

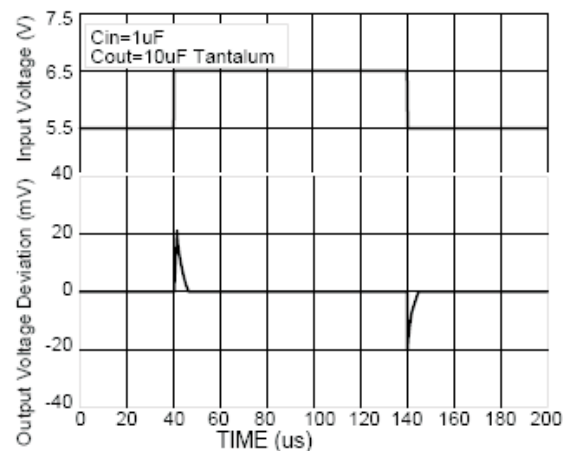

Fig.5 Line Transient Response

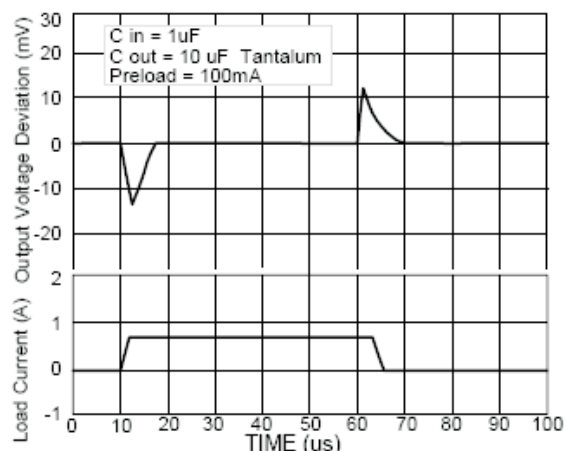

Fig.6 Load Transient Response