

Box-type metallized polyester film capacitor (Stacked version)

■ Outline Drawing

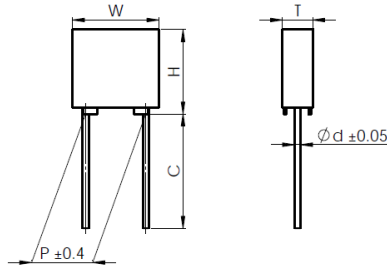

■ Features

- Metallized polyester film, stacked construction
- Plastic case (UL94 V-0), Epoxy resin sealing
- High dv/dt ability

■ Typical Applications:

- By-passing, blocking, coupling, decoupling,
- Pulse logic, timing, compact fluorescent lamps.
- Inverter for LCD monitors, automotive DC motor suppression

■ Specifications

Reference Standard	GB 7332(IEC 60384-2)		
Climatic Category	55/125/56		
Rated temperature	85°C		
Operating temperature	-55°C~125°C (+85°C to +125°C: decreasing factor 1.25% per °C for U_R)		
Rated Voltage	50/63V, 100V, 250V, 400V, 500V, 630V,700V		
Capacitance Range	0.0010μF ~ 2.2μF		
Capacitance Tolerance	±5% (J), ±10% (K), ±20% (M)		
Voltage Proof	1.4 U_R (5s)		
Dissipation Factor	Frequency	$C_N \leq 0.1\mu F$	$C_N > 0.1\mu F$
	1kHz	≤1.0%	≤1.0%
	10kHz	≤1.5%	≤1.5%
	100kHz	≤3.0%	-
Insulation Resistance	$U_R > 100V$	≥3 0000MΩ, $C_N \leq 0.33\mu F$ ≥10 000s, $C_N > 0.33\mu F$ (20°C, 100V, 1min)	
	$U_R \leq 100V$	≥15 000MΩ, $C_N \leq 0.33\mu F$ ≥5 000s, $0.33\mu F < C_N \leq 1\mu F$ ≥1 000s, $C_N > 1\mu F$ (20°C, 10V, 1min)	
Maximum Pulse Rise Time(dV/dt) If the working voltage(U) is lower than the rated voltage(U_R),the capacitor can be worked at a higher dV/dt. In this case, the maximum allowed dV/dt is obtain by multiplying the right value with U_R/U .	U_R (V)	dV/dt (V/μs)	
		pattern I	pattern II
	50/63	250	75
	100	300	85
	250	400	100
	400	600	150
	500	700	200
	630	800	
700	-	250	

■ Part number system

The 18 digits part number is formed as follow:

C24 Pattern I (High performance)

1	2	3	4	5	6	7	8	9	10	11	12	13	14	15	16	17	18
C	2	4							2	0							

C24 Pattern II (Reduced size)

1	2	3	4	5	6	7	8	9	10	11	12	13	14	15	16	17	18
C	2	4							2	S							

Digit 1 to 3 Series code

C24=CL23B

Digit 4 to 5 DC rated voltage

1H=50V 1J=63V 2A=100V 2E=250V

2G=400V 2H=500V 2J=630V 1V=700V

Digit 6 to 8 Rated capacitance value

For example : 103=10×10³pF=0.01uF

Digit 9 Capacitance tolerance

J=±5%,K=±10%,M=±20%

Digit 10 Lead pitch

2=5.0

Digit 11 Internal use

S=pattern II

Digit 12 to 15 Lead form and packaging code

Digit 16 to 18 Internal use

Table 1 lead dimensions and packaging code

Digit 12		Digit 13		Digit 14		Digit 15	
code	explanation	code	explanation	code	explanation	code	explanation
A	ammo-pack	2	F=5.0mm	0	straight	1	each cap. among two consecutive holes P3=12.7mm,H=18.5mm (For pitch=5.0mm)
C	straight lead “C” in the figure above	code	explanation			0	Length tolerance ±0.5mm Or standard length
		00	standard lead length (18mm~22mm)				
		45	lead length 4.5mm				

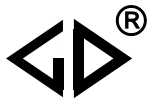

■ Dimensions(mm)

Capacitor Thickness: T	≤3.5	>3.5
Dimension Tolerance (W, H, T)	±0.2	±0.4

Pattern II (Reduced size)

50Vdc (30Vac)/63Vdc (40Vac) #						
C _N (μF)	W	H	T	P	d	Part number
0.15	7.2	6.5	2.5	5.0	0.5	C241J154-2S*****++
0.18	7.2	6.5	2.5	5.0	0.5	C241J184-2S*****++
0.22	7.2	6.5	2.5	5.0	0.5	C241J224-2S*****++
0.27	7.2	6.5	2.5	5.0	0.5	C241J274-2S*****++
0.33	7.2	7.5	3.5	5.0	0.5	C241J334-2S*****++
0.39	7.2	7.5	3.5	5.0	0.5	C241J394-2S*****++
0.47	7.2	7.5	3.5	5.0	0.5	C241J474-2S*****++
0.56	7.2	9.5	4.5	5.0	0.6	C241J564-2S*****++
0.68	7.2	9.5	4.5	5.0	0.6	C241J684-2S*****++
0.82	7.2	9.5	4.5	5.0	0.6	C241J824-2S*****++
1.0	7.2	10.0	5.0	5.0	0.6	C241J105-2S*****++
1.5	7.2	11.0	6.0	5.0	0.6	C241J155-2S*****++
2.2	7.2	11.0	6.0	5.0	0.6	C241J225-2S*****++

100 Vdc (63Vac)						
C _N (μF)	W	H	T	P	d	Part number
0.10	7.2	6.5	2.5	5.0	0.5	C242A104-2S*****++
0.12	7.2	6.5	2.5	5.0	0.5	C242A124-2S*****++
0.15	7.2	7.5	3.5	5.0	0.5	C242A154-2S*****++
0.18	7.2	7.5	3.5	5.0	0.5	C242A184-2S*****++
0.22	7.2	7.5	3.5	5.0	0.5	C242A224-2S*****++
0.27	7.2	9.5	4.5	5.0	0.6	C242A274-2S*****++
0.33	7.2	9.5	4.5	5.0	0.6	C242A334-2S*****++
0.39	7.2	9.5	4.5	5.0	0.6	C242A394-2S*****++
0.47	7.2	10.0	5.0	5.0	0.6	C242A474-2S*****++
0.56	7.2	10.0	5.0	5.0	0.6	C242A564-2S*****++
0.68	7.2	11.0	6.0	5.0	0.6	C242A684-2S*****++
0.82	7.2	11.0	6.0	5.0	0.6	C242A824-2S*****++
1.0	7.2	11.0	6.0	5.0	0.6	C242A105-2S*****++

250 Vdc (140Vac)						
C _N (μF)	W	H	T	P	d	Part number
0.022	7.2	6.5	2.5	5.0	0.5	C242E223-2S*****++
0.027	7.2	6.5	2.5	5.0	0.5	C242E273-2S*****++
0.033	7.2	6.5	2.5	5.0	0.5	C242E333-2S*****++
0.039	7.2	7.5	3.5	5.0	0.5	C242E393-2S*****++
0.047	7.2	7.5	3.5	5.0	0.5	C242E473-2S*****++
0.056	7.2	7.5	3.5	5.0	0.5	C242E563-2S*****++
0.068	7.2	7.5	3.5	5.0	0.5	C242E683-2S*****++
0.082	7.2	9.5	4.5	5.0	0.6	C242E823-2S*****++
0.10	7.2	9.5	4.5	5.0	0.6	C242E104-2S*****++
0.12	7.2	9.5	4.5	5.0	0.6	C242E124-2S*****++
0.15	7.2	10.0	5.0	5.0	0.6	C242E154-2S*****++
0.18	7.2	11.0	6.0	5.0	0.6	C242E184-2S*****++
0.22	7.2	11.0	6.0	5.0	0.6	C242E224-2S*****++

400 Vdc (160Vac)						
C _N (μF)	W	H	T	P	d	Part number
0.0056	7.2	6.5	2.5	5.0	0.5	C242G562-2S*****++
0.0068	7.2	6.5	2.5	5.0	0.5	C242G682-2S*****++
0.0082	7.2	6.5	2.5	5.0	0.5	C242G822-2S*****++
0.010	7.2	6.5	2.5	5.0	0.5	C242G103-2S*****++
0.012	7.2	6.5	2.5	5.0	0.5	C242G123-2S*****++
0.015	7.2	7.5	3.5	5.0	0.5	C242G153-2S*****++
0.018	7.2	7.5	3.5	5.0	0.5	C242G183-2S*****++
0.022	7.2	7.5	3.5	5.0	0.5	C242G223-2S*****++
0.027	7.2	7.5	3.5	5.0	0.5	C242G273-2S*****++
0.033	7.2	9.5	4.5	5.0	0.6	C242G333-2S*****++
0.039	7.2	9.5	4.5	5.0	0.6	C242G393-2S*****++
0.047	7.2	9.5	4.5	5.0	0.6	C242G473-2S*****++
0.051	7.2	10.0	5.0	5.0	0.6	C242G513-2S*****++
0.056	7.2	11.0	6.0	5.0	0.6	C242G563-2S*****++
0.068	7.2	11.0	6.0	5.0	0.6	C242G683-2S*****++
0.082	7.2	11.0	6.0	5.0	0.6	C242G823-2S*****++
0.10	7.2	11.0	6.0	5.0	0.6	C242G104-2S*****++

- Note: 1. “-”=capacitance tolerance code, M=±20%,K=±10%,J=±5%
 2. “*****”=lead form and packing code (refer to table 1).
 3. “#” when the rated voltage is 50Vdc,the digit 4~5 is 1H.

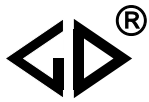

Pattern II (Reduced size)

500 Vdc/630(220Vac) [#]						
C _N (μF)	W	H	T	P	d	Part number
0.0018	7.2	6.5	2.5	5.0	0.5	C242J182-2S*****++
0.0022	7.2	6.5	2.5	5.0	0.5	C242J222-2S*****++
0.0027	7.2	6.5	2.5	5.0	0.5	C242J272-2S*****++
0.0033	7.2	6.5	2.5	5.0	0.5	C242J332-2S*****++
0.0039	7.2	6.5	2.5	5.0	0.5	C242J392-2S*****++
0.0047	7.2	6.5	2.5	5.0	0.5	C242J472-2S*****++
0.0056	7.2	7.5	3.5	5.0	0.5	C242J562-2S*****++
0.0068	7.2	7.5	3.5	5.0	0.5	C242J682-2S*****++
0.0082	7.2	7.5	3.5	5.0	0.5	C242J822-2S*****++
0.010	7.2	7.5	3.5	5.0	0.5	C242J103-2S*****++
0.012	7.2	9.5	4.5	5.0	0.6	C242J123-2S*****++
0.015	7.2	9.5	4.5	5.0	0.6	C242J153-2S*****++
0.018	7.2	9.5	4.5	5.0	0.6	C242J183-2S*****++
0.022	7.2	10.0	5.0	5.0	0.6	C242J223-2S*****++
0.027	7.2	11.0	6.0	5.0	0.6	C242J273-2S*****++
0.033	7.2	11.0	6.0	5.0	0.6	C242J333-2S*****++

700 Vdc (250Vac)						
C _N (μF)	W	H	T	P	d	Part number
0.0010	7.2	6.5	2.5	5.0	0.5	C241V102-2S*****++
0.0012	7.2	6.5	2.5	5.0	0.5	C241V122-2S*****++
0.0015	7.2	6.5	2.5	5.0	0.5	C241V152-2S*****++
0.0018	7.2	6.5	2.5	5.0	0.5	C241V182-2S*****++
0.0022	7.2	6.5	2.5	5.0	0.5	C241V222-2S*****++
0.0027	7.2	6.5	2.5	5.0	0.5	C241V272-2S*****++
0.0033	7.2	7.5	3.5	5.0	0.5	C241V332-2S*****++
0.0039	7.2	7.5	3.5	5.0	0.5	C241V392-2S*****++
0.0047	7.2	7.5	3.5	5.0	0.5	C241V472-2S*****++
0.0056	7.2	7.5	3.5	5.0	0.5	C241V562-2S*****++
0.0068	7.2	7.5	3.5	5.0	0.5	C241V682-2S*****++
0.0082	7.2	9.5	4.5	5.0	0.6	C241V822-2S*****++
0.010	7.2	9.5	4.5	5.0	0.6	C241V103-2S*****++
0.012	7.2	9.5	4.5	5.0	0.6	C241V123-2S*****++
0.015	7.2	10.0	5.0	5.0	0.6	C241V153-2S*****++
0.018	7.2	11.0	6.0	5.0	0.6	C241V183-2S*****++
0.022	7.2	11.0	6.0	5.0	0.6	C241V223-2S*****++

- Note: 1. “-”=capacitance tolerance code, M=±20%,K=±10%,J=±5%
 2. “*****”=lead dimensions and packing mode code (refer to table 1).
 3. “#” when the rated voltage is 500Vdc,the digit 4~5 is 2H.

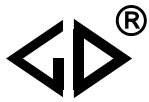

Pattern I (High performance)

50Vdc (30Vac)/63Vdc (40Vac) #						
C _N (μF)	W	H	T	P	d	Part number
0.0010	7.2	6.5	2.5	5.0	0.5	C241J102-20****+++
0.0012	7.2	6.5	2.5	5.0	0.5	C241J122-20****+++
0.0015	7.2	6.5	2.5	5.0	0.5	C241J152-20****+++
0.0018	7.2	6.5	2.5	5.0	0.5	C241J182-20****+++
0.0022	7.2	6.5	2.5	5.0	0.5	C241J222-20****+++
0.0027	7.2	6.5	2.5	5.0	0.5	C241J272-20****+++
0.0033	7.2	6.5	2.5	5.0	0.5	C241J332-20****+++
0.0039	7.2	6.5	2.5	5.0	0.5	C241J392-20****+++
0.0047	7.2	6.5	2.5	5.0	0.5	C241J472-20****+++
0.0056	7.2	6.5	2.5	5.0	0.5	C241J562-20****+++
0.0068	7.2	6.5	2.5	5.0	0.5	C241J682-20****+++
0.0082	7.2	6.5	2.5	5.0	0.5	C241J822-20****+++
0.010	7.2	6.5	2.5	5.0	0.5	C241J103-20****+++
0.012	7.2	6.5	2.5	5.0	0.5	C241J123-20****+++
0.015	7.2	6.5	2.5	5.0	0.5	C241J153-20****+++
0.018	7.2	6.5	2.5	5.0	0.5	C241J183-20****+++
0.022	7.2	6.5	2.5	5.0	0.5	C241J223-20****+++
0.027	7.2	6.5	2.5	5.0	0.5	C241J273-20****+++
0.033	7.2	6.5	2.5	5.0	0.5	C241J333-20****+++
0.039	7.2	6.5	2.5	5.0	0.5	C241J393-20****+++
0.047	7.2	6.5	2.5	5.0	0.5	C241J473-20****+++
0.056	7.2	6.5	2.5	5.0	0.5	C241J563-20****+++
0.068	7.2	6.5	2.5	5.0	0.5	C241J683-20****+++
0.082	7.2	6.5	2.5	5.0	0.5	C241J823-20****+++
0.10	7.2	6.5	2.5	5.0	0.5	C241J104-20****+++
0.12	7.2	6.5	2.5	5.0	0.5	C241J124-20****+++
0.15	7.2	7.5	3.5	5.0	0.5	C241J154-20****+++
0.18	7.2	7.5	3.5	5.0	0.5	C241J184-20****+++
0.22	7.2	7.5	3.5	5.0	0.5	C241J224-20****+++
0.27	7.2	9.5	4.5	5.0	0.6	C241J274-20****+++
0.33	7.2	9.5	4.5	5.0	0.6	C241J334-20****+++
0.39	7.2	9.5	4.5	5.0	0.6	C241J394-20****+++
0.47	7.2	10.0	5.0	5.0	0.6	C241J474-20****+++
0.56	7.2	10.0	5.0	5.0	0.6	C241J564-20****+++
0.68	7.2	11.0	6.0	5.0	0.6	C241J684-20****+++
0.82	7.2	11.0	6.0	5.0	0.6	C241J824-20****+++
1.0	7.2	11.0	6.0	5.0	0.6	C241J105-20****+++

100 Vdc (63Vac)						
C _N (μF)	W	H	T	P	d	Part number
0.0010	7.2	6.5	2.5	5.0	0.5	C242A102-20****+++
0.0012	7.2	6.5	2.5	5.0	0.5	C242A122-20****+++
0.0015	7.2	6.5	2.5	5.0	0.5	C242A152-20****+++
0.0018	7.2	6.5	2.5	5.0	0.5	C242A182-20****+++
0.0022	7.2	6.5	2.5	5.0	0.5	C242A222-20****+++
0.0027	7.2	6.5	2.5	5.0	0.5	C242A272-20****+++
0.0033	7.2	6.5	2.5	5.0	0.5	C242A332-20****+++
0.0039	7.2	6.5	2.5	5.0	0.5	C242A392-20****+++
0.0047	7.2	6.5	2.5	5.0	0.5	C242A472-20****+++
0.0056	7.2	6.5	2.5	5.0	0.5	C242A562-20****+++
0.0068	7.2	6.5	2.5	5.0	0.5	C242A682-20****+++
0.0082	7.2	6.5	2.5	5.0	0.5	C242A822-20****+++
0.010	7.2	6.5	2.5	5.0	0.5	C242A103-20****+++
0.012	7.2	6.5	2.5	5.0	0.5	C242A123-20****+++
0.015	7.2	6.5	2.5	5.0	0.5	C242A153-20****+++
0.018	7.2	6.5	2.5	5.0	0.5	C242A183-20****+++
0.022	7.2	6.5	2.5	5.0	0.5	C242A223-20****+++
0.027	7.2	6.5	2.5	5.0	0.5	C242A273-20****+++
0.033	7.2	6.5	2.5	5.0	0.5	C242A333-20****+++
0.039	7.2	6.5	2.5	5.0	0.5	C242A393-20****+++
0.047	7.2	6.5	2.5	5.0	0.5	C242A473-20****+++
0.056	7.2	6.5	2.5	5.0	0.5	C242A563-20****+++
0.068	7.2	6.5	2.5	5.0	0.5	C242A683-20****+++
0.082	7.2	6.5	2.5	5.0	0.5	C242A823-20****+++
0.10	7.2	7.5	3.5	5.0	0.5	C242A104-20****+++
0.12	7.2	9.5	4.5	5.0	0.6	C242A124-20****+++
0.15	7.2	9.5	4.5	5.0	0.6	C242A154-20****+++
0.18	7.2	9.5	4.5	5.0	0.6	C242A184-20****+++
0.22	7.2	10.0	5.0	5.0	0.6	C242A224-20****+++
0.27	7.2	10.0	5.0	5.0	0.6	C242A274-20****+++
0.33	7.2	11.0	6.0	5.0	0.6	C242A334-20****+++
0.39	7.2	11.0	6.0	5.0	0.6	C242A394-20****+++
0.47	7.2	11.0	6.0	5.0	0.6	C242A474-20****+++
0.56	7.2	11.0	6.0	5.0	0.6	C242A564-20****+++

- Note: 1. “-”=capacitance tolerance code, M=±20%,K=±10%,J=±5%
 2. “****”=lead form and packing code (refer to table 1).
 3. “#” when the rated voltage is 50Vdc,the digit 4~5 is 1H.

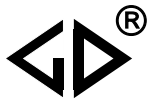

Pattern I (High performance)

250 Vdc (160Vac)						
C _N (μF)	W	H	T	P	d	Part number
0.0010	7.2	6.5	2.5	5.0	0.5	C242E102-20****+++
0.0012	7.2	6.5	2.5	5.0	0.5	C242E122-20****+++
0.0015	7.2	6.5	2.5	5.0	0.5	C242E152-20****+++
0.0018	7.2	6.5	2.5	5.0	0.5	C242E182-20****+++
0.0022	7.2	6.5	2.5	5.0	0.5	C242E222-20****+++
0.0027	7.2	6.5	2.5	5.0	0.5	C242E272-20****+++
0.0033	7.2	6.5	2.5	5.0	0.5	C242E332-20****+++
0.0039	7.2	6.5	2.5	5.0	0.5	C242E392-20****+++
0.0047	7.2	6.5	2.5	5.0	0.5	C242E472-20****+++
0.0056	7.2	6.5	2.5	5.0	0.5	C242E562-20****+++
0.0068	7.2	6.5	2.5	5.0	0.5	C242E682-20****+++
0.0082	7.2	6.5	2.5	5.0	0.5	C242E822-20****+++
0.010	7.2	6.5	2.5	5.0	0.5	C242E103-20****+++
0.012	7.2	6.5	2.5	5.0	0.5	C242E123-20****+++
0.015	7.2	6.5	2.5	5.0	0.5	C242E153-20****+++
0.018	7.2	6.5	2.5	5.0	0.5	C242E183-20****+++
0.022	7.2	7.5	3.5	5.0	0.5	C242E223-20****+++
0.027	7.2	7.5	3.5	5.0	0.5	C242E273-20****+++
0.033	7.2	7.5	3.5	5.0	0.5	C242E333-20****+++
0.039	7.2	7.5	3.5	5.0	0.5	C242E393-20****+++
0.047	7.2	9.5	4.5	5.0	0.6	C242E473-20****+++
0.056	7.2	9.5	4.5	5.0	0.6	C242E563-20****+++
0.068	7.2	9.5	4.5	5.0	0.6	C242E683-20****+++
0.082	7.2	10.0	5.0	5.0	0.6	C242E823-20****+++
0.10	7.2	10.0	5.0	5.0	0.6	C242E104-20****+++
0.12	7.2	11.0	6.0	5.0	0.6	C242E124-20****+++
0.15	7.2	11.0	6.0	5.0	0.6	C242E154-20****+++

400 Vdc (200Vac)						
C _N (μF)	W	H	T	P	d	Part number
0.0010	7.2	6.5	2.5	5.0	0.5	C242G102-20****+++
0.0012	7.2	6.5	2.5	5.0	0.5	C242G122-20****+++
0.0015	7.2	6.5	2.5	5.0	0.5	C242G152-20****+++
0.0018	7.2	6.5	2.5	5.0	0.5	C242G182-20****+++
0.0022	7.2	6.5	2.5	5.0	0.5	C242G222-20****+++
0.0027	7.2	6.5	2.5	5.0	0.5	C242G272-20****+++
0.0033	7.2	6.5	2.5	5.0	0.5	C242G332-20****+++
0.0039	7.2	6.5	2.5	5.0	0.5	C242G392-20****+++
0.0047	7.2	6.5	2.5	5.0	0.5	C242G472-20****+++
0.0056	7.2	7.5	3.5	5.0	0.5	C242G562-20****+++
0.0068	7.2	7.5	3.5	5.0	0.5	C242G682-20****+++
0.0082	7.2	7.5	3.5	5.0	0.5	C242G822-20****+++
0.010	7.2	7.5	3.5	5.0	0.5	C242G103-20****+++
0.012	7.2	9.5	4.5	5.0	0.6	C242G123-20****+++
0.015	7.2	9.5	4.5	5.0	0.6	C242G153-20****+++
0.018	7.2	9.5	4.5	5.0	0.6	C242G183-20****+++
0.022	7.2	10.0	5.0	5.0	0.6	C242G223-20****+++
0.027	7.2	11.0	6.0	5.0	0.6	C242G273-20****+++
0.033	7.2	11.0	6.0	5.0	0.6	C242G333-20****+++
0.039	7.2	11.0	6.0	5.0	0.6	C242G393-20****+++
0.047	7.2	11.0	6.0	5.0	0.6	C242G473-20****+++

- Note: 1. “-”=capacitance tolerance code, M=±20%,K=±10%,J=±5%
 2. “****”=lead form and packing code (refer to table 1).

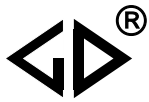

Pattern I (High performance)

500 Vdc (220Vac)						
C _N (μF)	W	H	T	P	d	Part number
0.0010	7.2	6.5	2.5	5.0	0.5	C242H102-20****+++
0.0012	7.2	6.5	2.5	5.0	0.5	C242H122-20****+++
0.0015	7.2	6.5	2.5	5.0	0.5	C242H152-20****+++
0.0018	7.2	6.5	2.5	5.0	0.5	C242H182-20****+++
0.0022	7.2	6.5	2.5	5.0	0.5	C242H222-20****+++
0.0027	7.2	6.5	2.5	5.0	0.5	C242H272-20****+++
0.0033	7.2	7.5	3.5	5.0	0.5	C242H332-20****+++
0.0039	7.2	7.5	3.5	5.0	0.5	C242H392-20****+++
0.0047	7.2	7.5	3.5	5.0	0.5	C242H472-20****+++
0.0056	7.2	7.5	3.5	5.0	0.5	C242H562-20****+++
0.0068	7.2	9.5	4.5	5.0	0.6	C242H682-20****+++
0.0082	7.2	9.5	4.5	5.0	0.6	C242H822-20****+++
0.010	7.2	9.5	4.5	5.0	0.6	C242H103-20****+++
0.012	7.2	9.5	4.5	5.0	0.6	C242H123-20****+++
0.015	7.2	10.0	5.0	5.0	0.6	C242H153-20****+++
0.018	7.2	11.0	6.0	5.0	0.6	C242H183-20****+++
0.022	7.2	11.0	6.0	5.0	0.6	C242H223-20****+++
0.027	7.2	11.0	6.0	5.0	0.6	C242H273-20****+++

630 Vdc (220Vac)						
C _N (μF)	W	H	T	P	d	Part number
0.0010	7.2	6.5	2.5	5.0	0.5	C242J102-20****+++
0.0012	7.2	6.5	2.5	5.0	0.5	C242J122-20****+++
0.0015	7.2	6.5	2.5	5.0	0.5	C242J152-20****+++
0.0018	7.2	7.5	3.5	5.0	0.5	C242J182-20****+++
0.0022	7.2	7.5	3.5	5.0	0.5	C242J222-20****+++
0.0027	7.2	7.5	3.5	5.0	0.5	C242J272-20****+++
0.0033	7.2	7.5	3.5	5.0	0.5	C242J332-20****+++
0.0039	7.2	7.5	3.5	5.0	0.5	C242J392-20****+++
0.0047	7.2	9.5	4.5	5.0	0.6	C242J472-20****+++
0.0056	7.2	9.5	4.5	5.0	0.6	C242J562-20****+++
0.0068	7.2	9.5	4.5	5.0	0.6	C242J682-20****+++
0.0082	7.2	9.5	4.5	5.0	0.6	C242J822-20****+++
0.010	7.2	10.0	5.0	5.0	0.6	C242J103-20****+++
0.012	7.2	11.0	6.0	5.0	0.6	C242J123-20****+++
0.015	7.2	11.0	6.0	5.0	0.6	C242J153-20****+++
0.018	7.2	11.0	6.0	5.0	0.6	C242J183-20****+++

- Note: 1. “-”=capacitance tolerance code, M=±20%,K=±10%,J=±5%
 2. “****”=lead form and packing code (refer to table 1).

■ MAX. VOLTAGE(Vr.m.s) VERSUS FREQUENCY

Pattern II (Reduced sized)

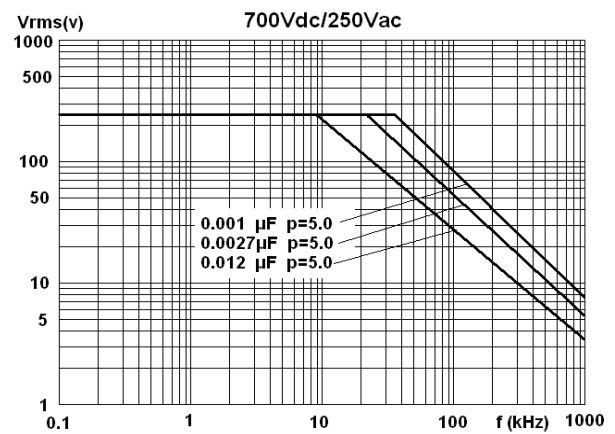
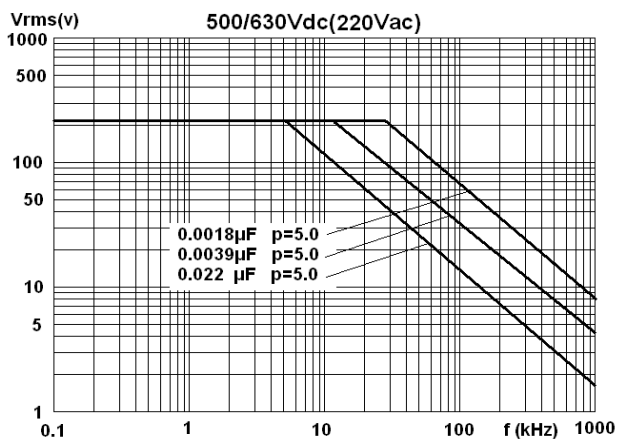
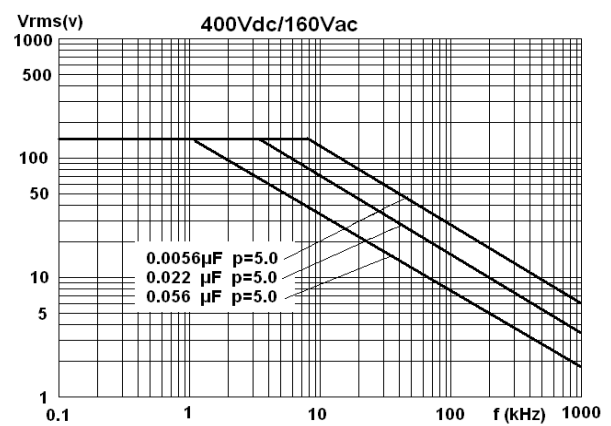
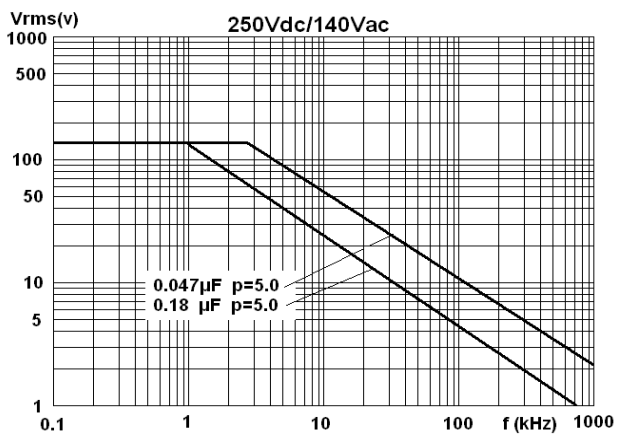
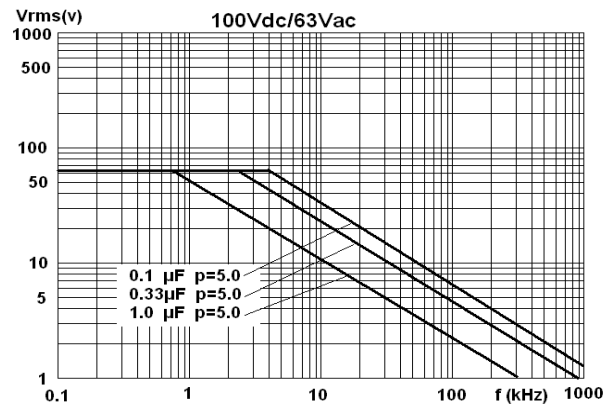
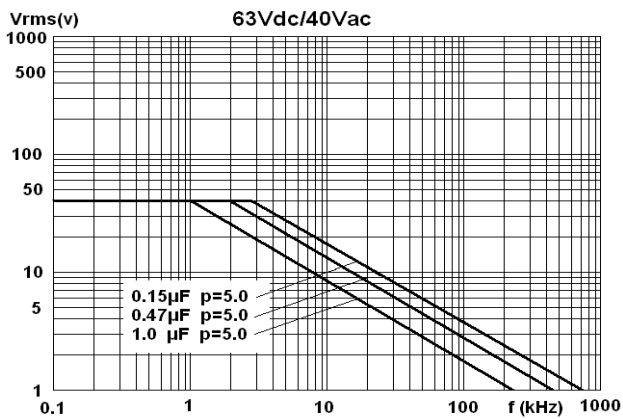

Note: sinusoidal wave-form, environment temperature $\leq 85^{\circ}\text{C}$, internal temperature rise $\Delta T=15^{\circ}\text{C}$, p (pitch) in mm..

■ MAX. VOLTAGE(Vr.m.s) VERSUS FREQUENCY

Pattern I (High performance)

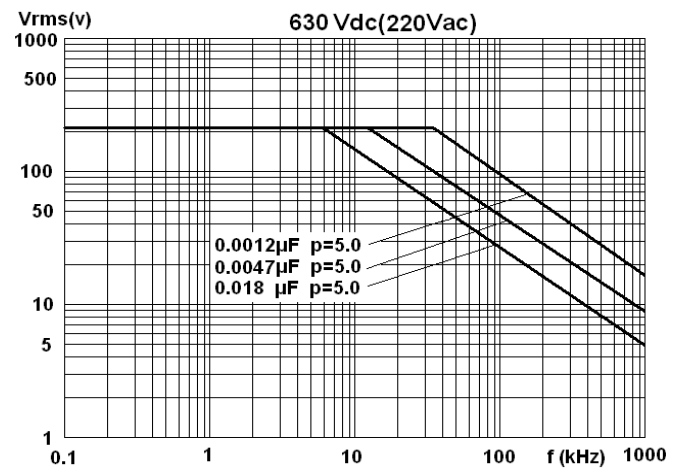
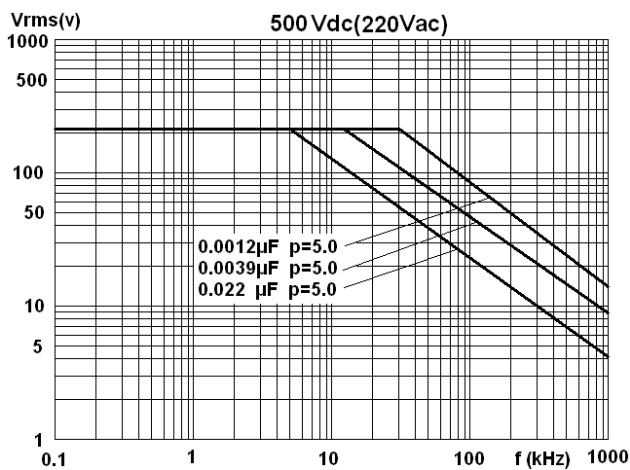
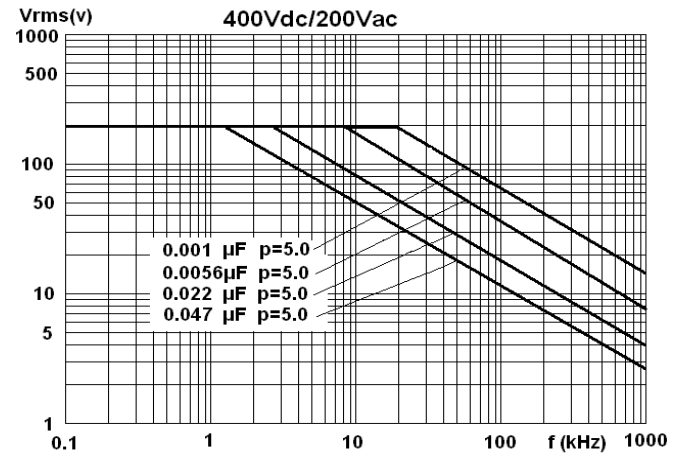
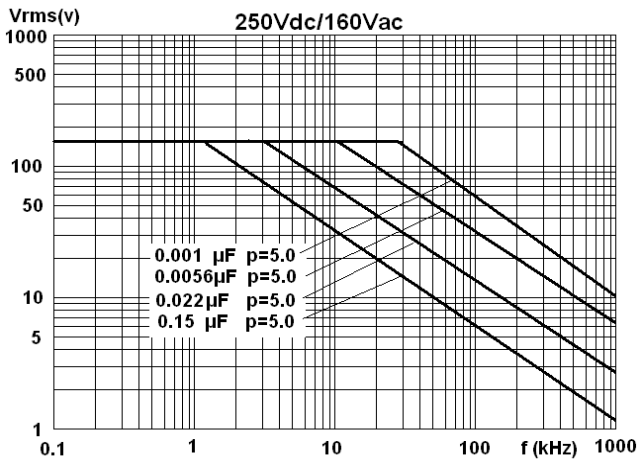
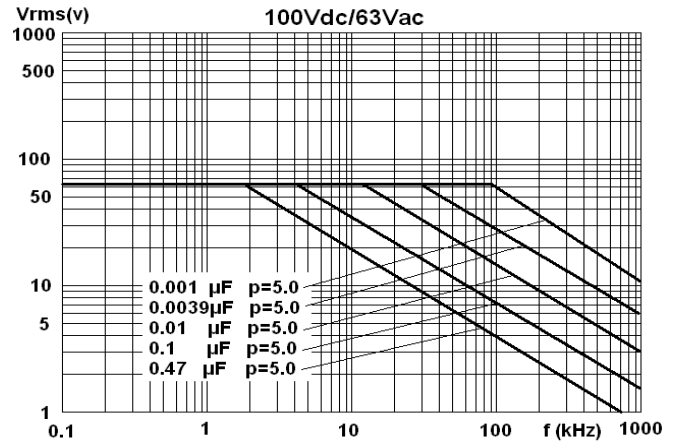
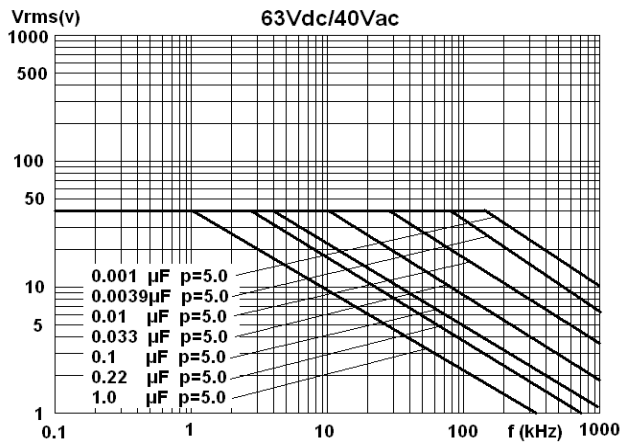

Note: sinusoidal wave-form, environment temperature $\leq 85^{\circ}\text{C}$, internal temperature rise $\Delta T = 15^{\circ}\text{C}$, p (pitch) in mm..

■ Test Method And Performance

No.	Item	Performance	Test method GB/T 7332 (IEC60384-2)
1	Capacitance tolerance	J($\pm 5\%$), K($\pm 10\%$), M($\pm 20\%$)	1kHz, 3% U_R (V_{rms})max.
2	Tangent of the loss angle	$\tan\delta \leq 0.010$ (1kHz) $\tan\delta \leq 0.015$ (10kHz) $\tan\delta \leq 0.030$ (100kHz, $C < 0.1\mu F$)	1kHz or 10 kHz or 100 kHz $\leq 3\% U_R$ (V_{rms}) or 1 V_{rms} (whichever is the minor)
3	Dielectric strength	There shall be no breakdown or flashover.	1.4 U_R , 5s
4	Insulation resistance	$U_R \leq 100V$ $\geq 15\ 000M\Omega$, $C_N \leq 0.33\mu F$ $\geq 5\ 000s$, $0.33\mu F < C_N \leq 1\mu F$ $\geq 1\ 000s$, $C_N > 1\mu F$ $U_R > 100V$ $\geq 3\ 0000M\Omega$, $C_N \leq 0.33\mu F$ $\geq 10\ 000s$, $C_N > 0.33\mu F$,	$U_R \leq 100V$, Charging voltage 10V $U_R > 100V$, Charging voltage 100V 20°C, measuring after applying voltage for 1 minute
5	Solderability	Good quality of tinning	Solder temperature: 245°C $\pm 5^\circ C$ Immersion time: 2.0s $\pm 0.5s$
6	Initial measurement	Capacitance, $\tan\delta$ (10kHz)	
	Terminal strength	There shall be no visible damage	Tension U_{a1} : Pull: $\phi d = 0.5mm, 5N$; $\phi d = 0.6mm, 10N$ Bend U_b : The pull of bend: $\phi d = 0.5mm, 2.5N$ $\phi d = 0.6mm, 5N$ The terminals shall be bent 2 times in each direction.
	Resistance to solder heat	There shall be no visible damage	Solder temperature: 260°C $\pm 5^\circ C$ Immersion time: 10s $\pm 1s$
	Final measurement	$\Delta C/C \leq \pm 2\%$ (relative to the initial value) Increase of $\tan\delta$: ≤ 0.003 (10kHz)	
7	Component's resistance of solvents	The dimensions shall reach the requirement of Table 1, and the change of capacitor weight shall not beyond 1%.	Solvent: Industrial isopropanol. Solvent temperature: 23°C $\pm 5^\circ C$ Immersion time: 5min $\pm 0.5min$ Reverting time: 48h
8	Initial measurement	Capacitance, $\tan\delta$ (10kHz)	
	Rapid change of temperature	There shall be no evidence of deterioration.	$\theta_A = -55^\circ C$, $\theta_B = +125^\circ C$ 5 cycles, Duration: t=30min
	Vibration	There shall be no evidence of deterioration.	Amplitude 0.75mm or acceleration 98m/s ² (whichever is the smaller severity), f: 10Hz to 500Hz. Three directions, 2h foreach direction, total 6h.
	Bump	There shall be no evidence of deterioration.	4 000 times, Acceleration: 390m/s ² , Pulse duration, 6ms
	Final measurement	$\Delta C/C \leq \pm 5\%$ (relative to the initial value) Increase of $\tan\delta$: ≤ 0.003 (10kHz) IR: $\geq 50\%$ of the rated value	
9	climate sequence	Initial measurement	Capacitance, $\tan\delta$ (10kHz)
		Dry heat	+125°C, 16h

No.	Item	Performance	Test method GB/T 7332 (IEC60384-2)	
9	climate sequence (continue)	Damp heat, Cyclic	Test Db, Severity: b, the first cycle	
		Cold	-55°C, 2h	
		Low air pressure	There shall be no permanent break down, flashover or other harmful deformation when applying U_R at the last 1 minute.	15°C~35°C, 8.5kPa, 1h,
		Damp heat, cyclic other		Test Db, Severity b, the other cycles, Applying U_R for 1 minute after the test finished.
		Final measu rement	There shall be no evidence of deterioration and the marking shall be legible. $\Delta C/C \leq \pm 5\%$ (relative to the initial value) Increase of $\tan\delta$: ≤ 0.005 (10kHz) IR: $\geq 50\%$ of the rated value	
10	Damp heat steady state	There shall be no evidence of deterioration and the marking shall be legible. $\Delta C/C \leq \pm 5\%$ (relative to the initial value) Increase of $\tan\delta \leq 0.005$ (10kHz) IR: $\geq 50\%$ of the rated value	Temperature: 40°C $\pm 2^\circ\text{C}$ Humidity: 93 $\frac{+2}{-3}$ %RH Duration: 56 days	
11	Endurance	There shall be no evidence of deterioration and the marking shall be legible. $\Delta C/C \leq \pm 5\%$ (relative to the initial value) Increase of $\tan\delta$: ≤ 0.003 (10kHz) IR: $\geq 50\%$ of the rated value	Temperature: +85°C Voltage: 1.25× U_R Duration: 2 000h or Temperature: +125°C Voltage: 1.25× U_c ($U_c=0.5U_R$) Duration: 2 000h	
12	Temperature characteristic	Measuring capacitance at test point b, d, f: Characteristic at lower category temperature -55°C: $-10\% \leq (C_b - C_d)/C_d \leq 0\%$ Characteristic at upper category temperature +125°C: $0\% \leq (C_f - C_d)/C_d \leq +18\%$ I.R. (test at point f): $U_R \leq 100\text{V}$: $\geq 15\text{M}\Omega$ ($C \leq 0.33\mu\text{F}$) $\geq 5\text{s}$ ($C > 0.33\mu\text{F}$) $U_R > 100\text{V}$: $\geq 30\text{M}\Omega$ ($C \leq 0.33\mu\text{F}$) $\geq 10\text{s}$ ($C > 0.33\mu\text{F}$)	Static method: The Capacitors should be kept at the following temperature in turn: a(20 ± 2) °C, b(-55 ± 3) °C, d(20 ± 2) °C, f(+125 ± 2) °C, g(20 ± 2) °C	
13	Charging and discharging	$\Delta C/C \leq \pm 5\%$ (relative to the initial value) Increase of $\tan\delta$: ≤ 0.003 (10kHz, $C \leq 1.0\mu\text{F}$) ≤ 0.002 (1kHz, $C > 1.0\mu\text{F}$) IR: $\geq 50\%$ of the rated value	Times: 10 000 Duration of charging: 0.5s Duration of discharging: 0.5s Charging voltage: rated voltage Charging resistance: 220/ C_N (Ω) Discharging resistance: $R=10/C_N$ (Ω) or 20 Ω (whichever is the greater) C_N : rated capacitance (μF)	

■ **Quality ensuring test (before shipment):**

Inspection item (each batch)	Inspection level (GB/T 2828.1)	
	IL	AQL
Appearance inspection	S-4	1.5%
Dimensions		
Capacitance	II	0.65%
Tangent of the loss angle		
Dielectric strength		
Insulation resistance		
Solderability	S-3	2.5%

■ **Marking**

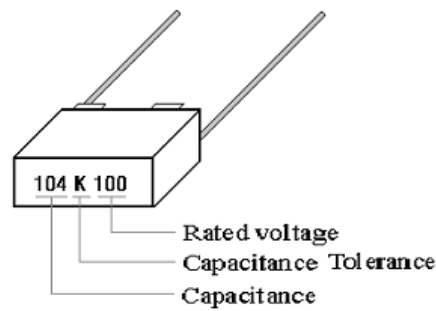

■ **Taping specification for box-type capacitor**

▲ **Outline Drawing**

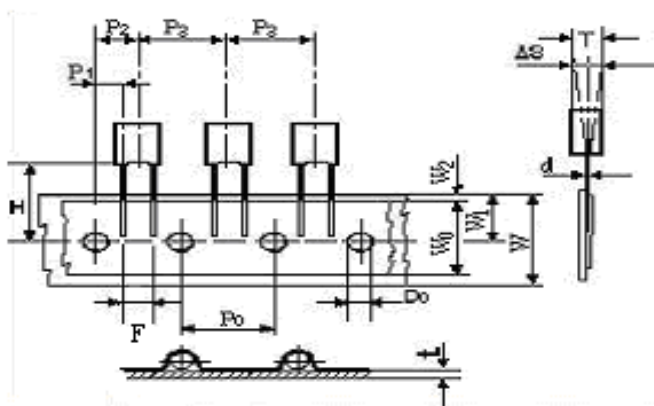

Fig 1

▲ Taping Dimensions(mm)

Technology index title	Code	Dimensions	
		P=5.0	Tolerance
Taping type	—	Fig 1	—
Part number Digit12-15	Ammo-pack	A201	
Taping pitch	P ₃	12.7	±1.0
Feed hole pitch	P ₀	12.7	±0.3
Center of wire	P ₁	3.85	±0.7
Center of body	P ₂	6.35	±1.3
Pitch of taping wire	F	5.0	+0.6 -0.1
Component alignment	△S	0	±2.0
Height of component from tape center	H	18.5	±0.5
Carrier tape width	W	18.0	+1.0 -0.5
Hold down tape width	W ₀	6min	—
Hole position	W ₁	9.0	±0.5
Hold down tape sition	W ₂	3max	—
Feed hole dia.	D ₀	4.0	±0.2
Tape thickness	t	0.7	±0.2

▲ Packing Quantity

Pitch (mm)	Box thickness T(mm)	Ammo-pack (pcs/box)	
		Domestic	Export
5.0	2.5	2 500	2 000
	3.5	1 700	1 500
	4.5	1 400	1 300
	5.0	1 200	1 000
	6.0	1 000	800

■ Packing box sizes(mm)

1. Out packing box for bulk

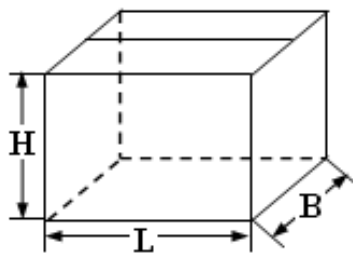

L:375±5
B:375±5
H:265±5

2. Inner packing box for bulk

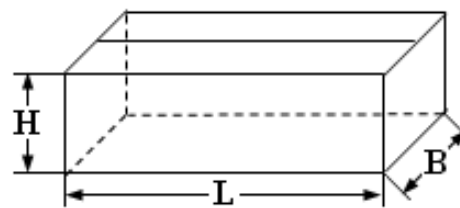

L:355±3
B:175±3
H:118±3

3. Box sizes for Ammo-pack

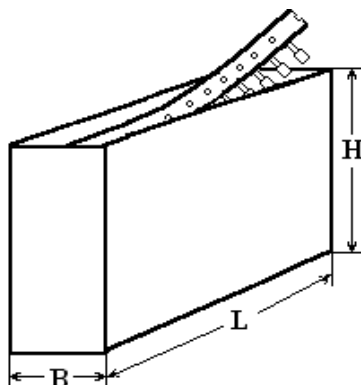

L:330±3
B:48±3
H:260±3