

SOT-323 Plastic-Encapsulate MOSFETS

2N7002KW N-Channel MOSFET

$V_{(BR)DSS}$	$R_{DS(on)MAX}$	I_D
60V	2.5Ω@10V	340mA
	3Ω@4.5V	

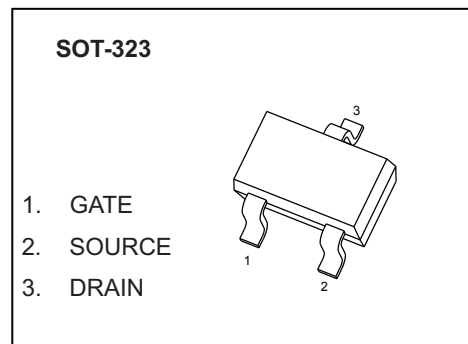

FEATURE

- High density cell design for Low $R_{DS(on)}$
- Voltage controlled small signal switch
- Rugged and reliable
- High saturation current capability
- ESD protected

APPLICATION

- Load Switch for Portable Devices
- DC/DC Converter

MARKING

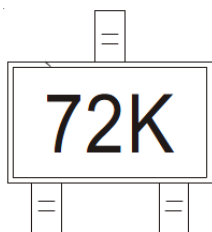

Equivalent Circuit

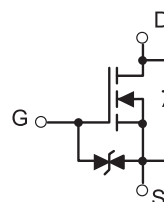

MOSFET MAXIMUM RATINGS ($T_a=25^{\circ}C$ unless otherwise noted)

Symbol	Parameter	Value	Unit
V_{DS}	Drain-Source Voltage	60	V
V_{GS}	Gate-Source Voltage	±20	V
I_D	Continuous Drain Current	340	mA
I_{DM}	Pulsed Drain Current(note1)	800	mA
P_D	Power Dissipation	0.2	W
T_j	Junction Temperature	150	°C
T_{stg}	Storage Temperature	-55~+150	°C
$R_{\theta JA}$	Thermal Resistance from Junction to Ambient	625	°C/W

MOSFET ELECTRICAL CHARACTERISTICS

$T_a=25\text{ }^\circ\text{C}$ unless otherwise specified

Parameter	Symbol	Test Condition	Min	Typ	Max	Unit
STATIC PARAMETERS						
Drain-source Breakdown Voltage	$V_{(BR)DSS}$	$V_{GS} = 0V, I_D = 250\mu A$	60			V
GateThreshold Voltage (note 2)	$V_{GS(th)}$	$V_{DS} = V_{GS}, I_D = 1mA$	1	1.3	2.5	V
Zero Gate Voltage Drain Current	I_{DSS}	$V_{DS} = 48V, V_{GS} = 0V$			1	μA
Gate-Source Leakage Current	I_{GSS}	$V_{GS} = \pm 20V, V_{DS} = 0V$			± 10	μA
Drain-Source On-Resistance (note 2)	$R_{DS(on)}$	$V_{GS} = 4.5V, I_D = 200mA$		1.1	3	Ω
		$V_{GS} = 10V, I_D = 500mA$		0.9	2.5	Ω
DYNAMIC PARAMETERS (note 3)						
Input Capacitance	C_{iss}	$V_{DS} = 10V, V_{GS} = 0V, f = 1MHz$			40	pF
Output Capacitance	C_{oss}				30	pF
Reverse Transfer Capacitance	C_{rss}				10	pF
SWITCHING PARAMETERS (note 3)						
Turn-on Delay Time	$t_{d(on)}$	$V_{GS} = 10V, V_{DD} = 50V, R_G = 50\Omega$			10	ns
Turn-off Delay Time	$t_{d(off)}$	$R_{GS} = 50\Omega, R_L = 250\Omega$			15	ns
Reverse Recovery Time	t_{rr}	$V_{GS} = 0V, I_S = 300mA, V_R = 25V, di/dt = -100A/\mu s$		30		ns
Recovered Charge	Q_r	$V_{GS} = 0V, I_S = 300mA, V_R = 25V, di/dt = -100A/\mu s$		30		nC
GATE-SOURCE ZENER DIODE						
Gate-Source Breakdown Voltage	BV_{GSO}	$I_{GS} = \pm 1mA$ (Open Drain)	± 21.5		± 30	V
DRAIN-SOURCE DIODE						
Diode Forward Voltage (note 2)	V_{SD}	$I_S = 300mA, V_{GS} = 0V$			1.5	V
Continuous Diode Forward Current	I_S				0.2	A
Pulsed Diode Forward Current (note 1)	I_{SM}				0.53	A

Notes :

1. Repetitive rating: Pluse width limited by junction temperature.
2. Pulse Test : Pulse width $\leq 300\mu s$, duty cycle $\leq 2\%$.
3. Guaranteed by design, not subject to production testing.

Typical Characteristics

Output Characteristics

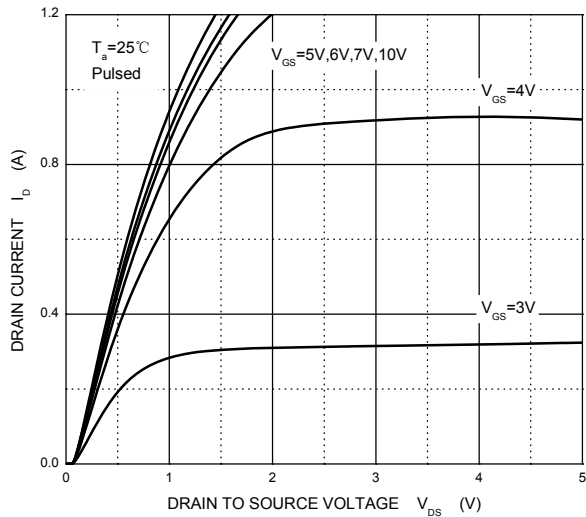

Transfer Characteristics

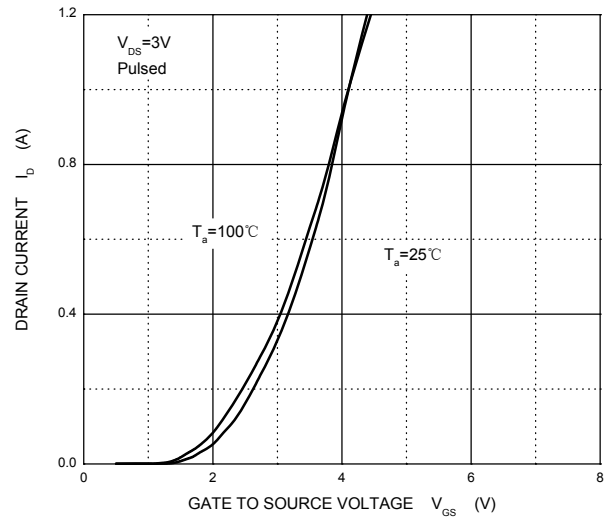

$R_{DS(ON)}$ — I_D

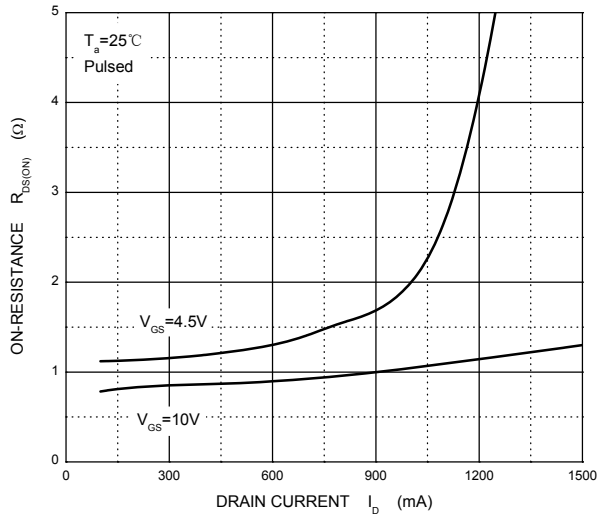

$R_{DS(ON)}$ — V_{GS}

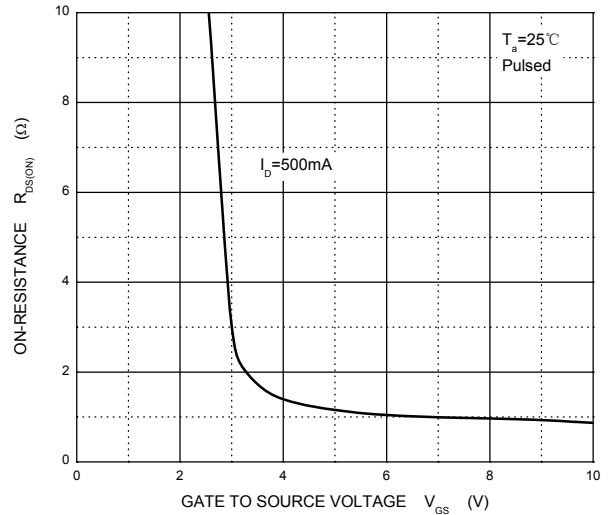

I_S — V_{SD}

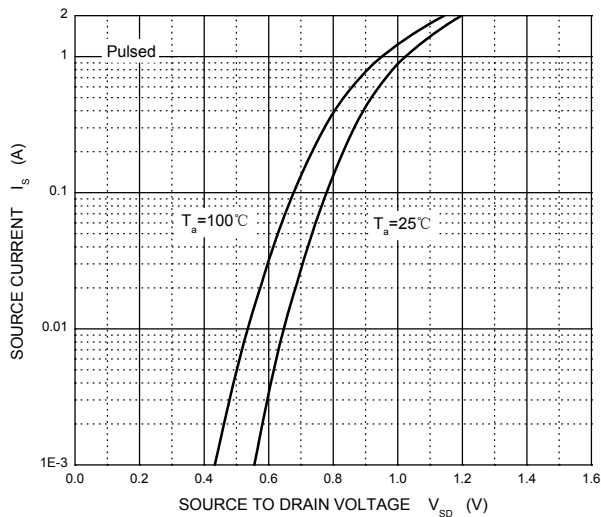

Threshold Voltage

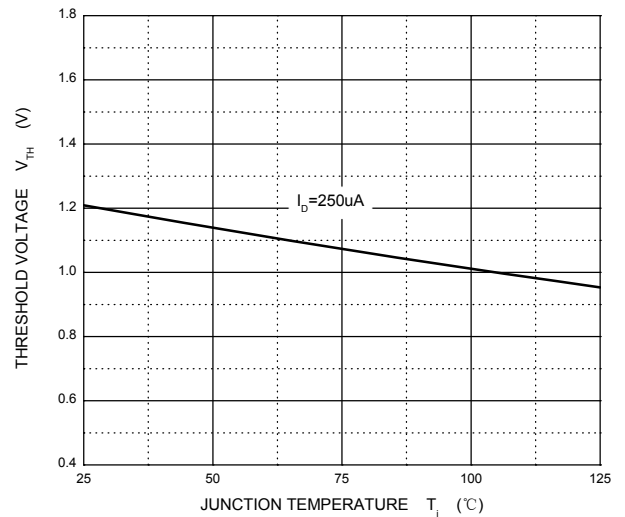

SOT-323 Package Outline Dimensions

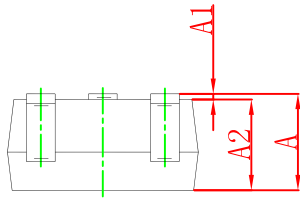
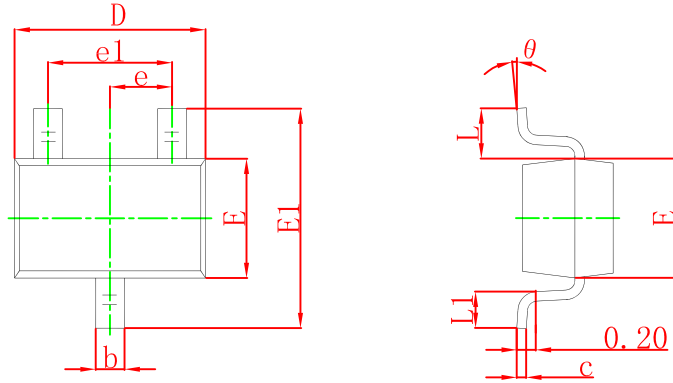

Symbol	Dimensions In Millimeters		Dimensions In Inches	
	Min	Max	Min	Max
A	0.900	1.100	0.035	0.043
A1	0.000	0.100	0.000	0.004
A2	0.900	1.000	0.035	0.039
b	0.200	0.400	0.008	0.016
c	0.080	0.150	0.003	0.006
D	2.000	2.200	0.079	0.087
E	1.150	1.350	0.045	0.053
E1	2.150	2.450	0.085	0.096
e	0.650 TYP		0.026 TYP	
e1	1.200	1.400	0.047	0.055
L	0.525 REF		0.021 REF	
L1	0.260	0.460	0.010	0.018
θ	0°	8°	0°	8°

SOT-323 Suggested Pad Layout

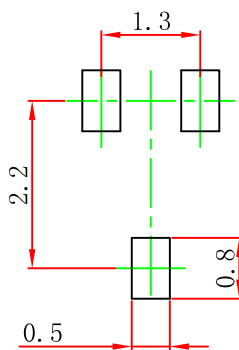

Note:

1. Controlling dimension: in millimeters.
2. General tolerance: ± 0.05 mm.
3. The pad layout is for reference purposes only.

NOTICE

JSCJ reserves the right to make modifications, enhancements, improvements, corrections or other changes without further notice to any product herein. JSCJ does not assume any liability arising out of the application or use of any product described herein.

SOT-323 Tape and Reel

SOT-323 Embossed Carrier Tape

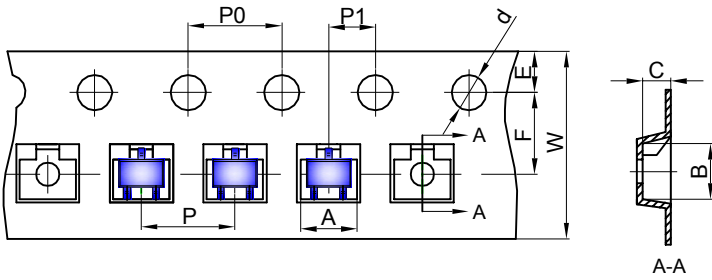

Packaging Description:

SOT-323 parts are shipped in tape. The carrier tape is made from a dissipative (carbon filled) polycarbonate resin. The cover tape is a multilayer film (Heat Activated Adhesive in nature) primarily composed of polyester film, adhesive layer, sealant, and anti-static sprayed agent. These reeled parts in standard option are shipped with 3,000 units per 7" or 17.8cm diameter reel. The reels are clear in color and is made of polystyrene plastic (anti-static coated).

Dimensions are in millimeter										
Pkg type	A	B	C	d	E	F	P0	P	P1	W
SOT-323	2.25	2.55	1.19	Ø1.55	1.75	3.50	4.00	4.00	2.00	8.00

SOT-323 Tape Leader and Trailer

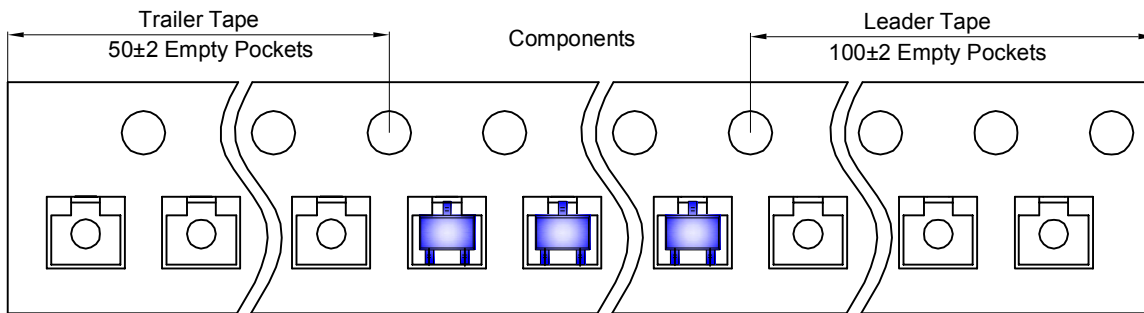

SOT-323 Reel

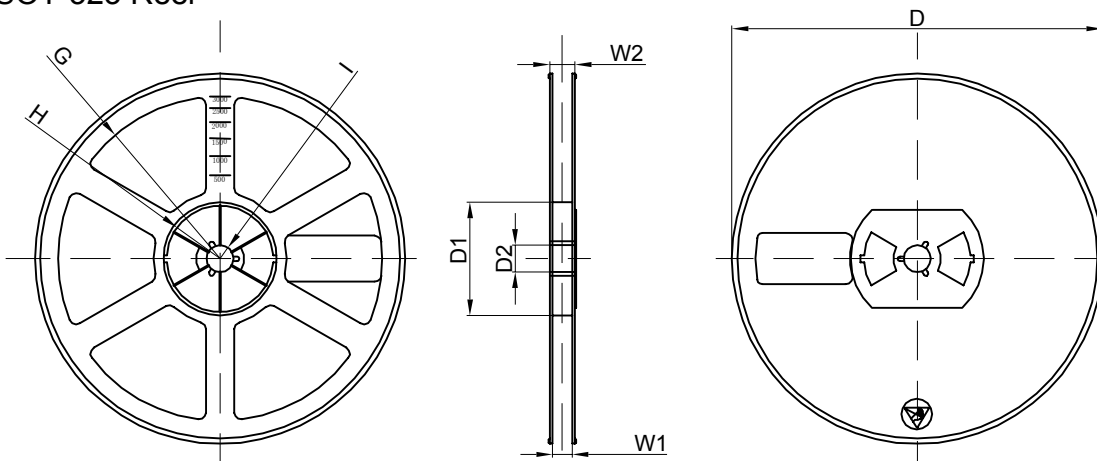

Dimensions are in millimeter								
Reel Option	D	D1	D2	G	H	I	W1	W2
7" Dia	Ø178.00	54.40	13.00	R78.00	R25.60	R6.50	9.50	12.30

REEL	Reel Size	Box	Box Size(mm)	Carton	Carton Size(mm)	G.W.(kg)
3000 pcs	7 inch	30,000 pcs	203×203×195	120,000 pcs	438×438×220	