

SOT-89-3L Plastic-Encapsulate MOSFETS

CJA03N10S N-Channel MOSFET

| | | |
|---------------|-----------------|-------|
| $V_{(BR)DSS}$ | $R_{DS(on)MAX}$ | I_D |
| 100V | 140mΩ@10V | 3A |

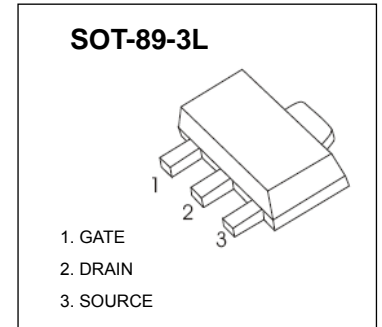

DESCRIPTION

The CJA03N10S uses advanced trench technology and design to provide excellent $R_{DS(ON)}$ with low gate charge. This device is suitable for use in a wide variety of applications.

FEATURES

- Lead free product is acquired
- Special process technology for high ESD capability
- High density cell design for ultra low $R_{DS(on)}$
- Good stability and uniformity with high E_{AS}
- Excellent package for good heat dissipation

APPLICATION

- Power switching application
- Hard switching and high frequency circuits
- Uninterruptible power supply

MARKING

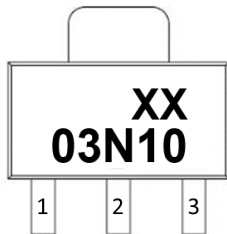

XX: Data Code

Equivalent Circuit

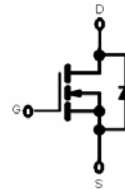

Maximum ratings ($T_a=25^\circ\text{C}$ unless otherwise noted)

| Parameter | Symbol | Value | Unit |
|---|-----------------|----------|--------------------|
| Drain-Source Voltage | V_{DS} | 100 | V |
| Gate-Source Voltage | V_{GS} | ±20 | V |
| Continuous Drain Current | I_D | 3 | A |
| Pulsed Drain Current (note 1) | I_{DM} | 20 | A |
| Power Dissipation | P_D | 0.5 | W |
| Thermal Resistance from Junction to Ambient (note 2) | $R_{\theta JA}$ | 250 | $^\circ\text{C/W}$ |
| Junction Temperature | T_J | 150 | $^\circ\text{C}$ |
| Storage Temperature | T_{STG} | -55~+150 | $^\circ\text{C}$ |

MOSFET ELECTRICAL CHARACTERISTICS

$T_a=25\text{ }^\circ\text{C}$ unless otherwise specified

| Parameter | Symbol | Test Condition | Min | Typ | Max | Unit |
|---|---------------|--|-----|------|-----------|------------|
| STATIC CHARACTERISTICS | | | | | | |
| Drain-source breakdown voltage | $V_{(BR)DSS}$ | $V_{GS} = 0V, I_D = 250\mu A$ | 100 | | | V |
| Zero gate voltage drain current | I_{DSS} | $V_{DS} = 100V, V_{GS} = 0V$ | | | 1 | μA |
| Gate-body leakage current | I_{GSS} | $V_{GS} = \pm 20V, V_{DS} = 0V$ | | | ± 100 | nA |
| Gate threshold voltage (note 3) | $V_{GS(th)}$ | $V_{DS} = V_{GS}, I_D = 250\mu A$ | 1 | 1.6 | 3 | V |
| Drain-source on-resistance (note 3) | $R_{DS(on)}$ | $V_{GS} = 10V, I_D = 3A$ | | 113 | 140 | m Ω |
| Forward transconductance (note 3) | g_{FS} | $V_{DS} = 5V, I_D = 2.9A$ | 3 | | | S |
| Diode forward voltage (note 3) | V_{SD} | $I_S = 3A, V_{GS} = 0V$ | | | 1.2 | V |
| DYNAMIC CHARACTERISTICS (note 4) | | | | | | |
| Input capacitance | C_{iss} | $V_{DS} = 25V, V_{GS} = 0V, f = 1MHz$ | | 607 | | pF |
| Output capacitance | C_{oss} | | | 38 | | pF |
| Reverse transfer capacitance | C_{rss} | | | 20 | | pF |
| SWITCHING CHARACTERISTICS (note 4) | | | | | | |
| Turn-on delay time | $t_{d(on)}$ | $V_{GS} = 10V, V_{DS} = 30V,$ $R_{GEN} = 2.5\Omega, I_D = 2A, R_L = 15\Omega$ | | 9.7 | | ns |
| Turn-on rise time | t_r | | | 6.5 | | ns |
| Turn-off delay time | $t_{d(off)}$ | | | 31 | | ns |
| Turn-off fall time | t_f | | | 8 | | ns |
| Total gate charge | Q_g | $V_{DS} = 30V, V_{GS} = 10V, I_D = 3A$ | | 13.7 | | nC |
| Gate-source Charge | Q_{gs} | | | 3.1 | | nC |
| Gate-drain Charge | Q_{gd} | | | 4.5 | | nC |

Notes :

1. Repetitive rating : Pulse width limited by junction temperature.
2. Surface mounted on FR4 board , $t \leq 10s$.
3. Pulse Test : Pulse Width $\leq 300\mu s$, Duty Cycle $\leq 2\%$.
4. Guaranteed by design, not subject to producing.

Typical Characteristics

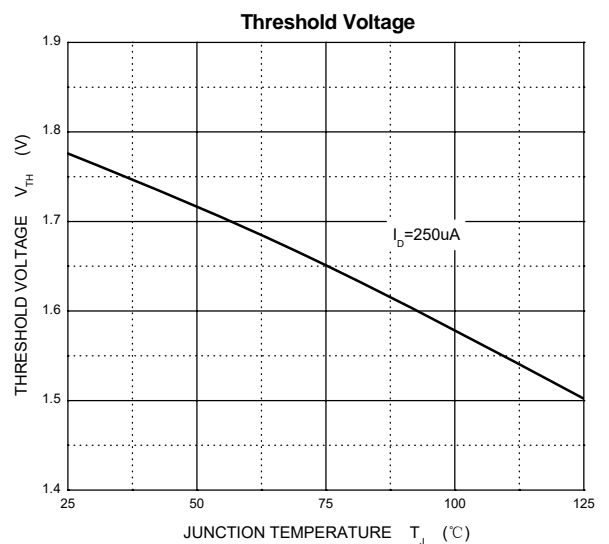
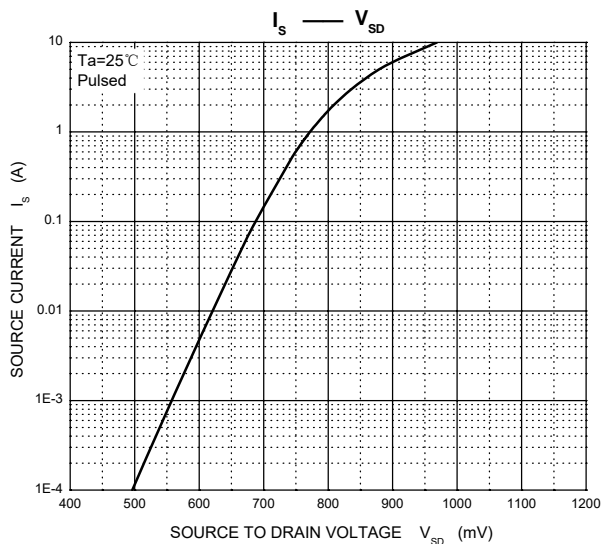
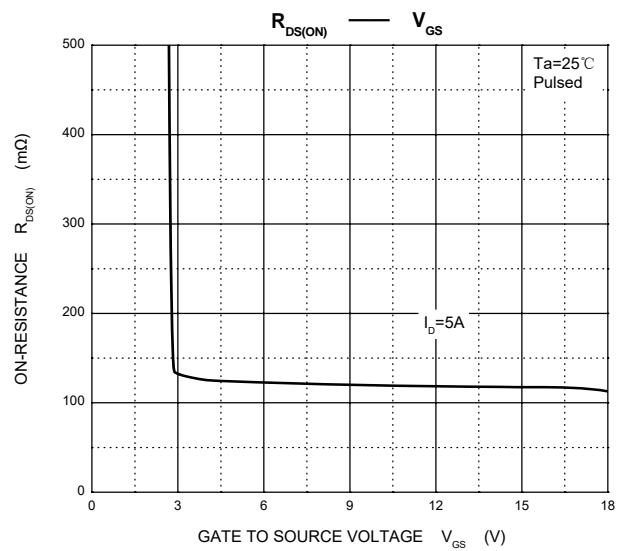
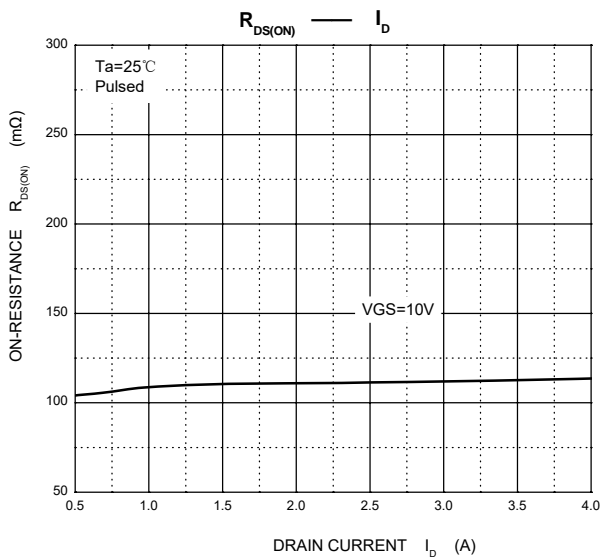
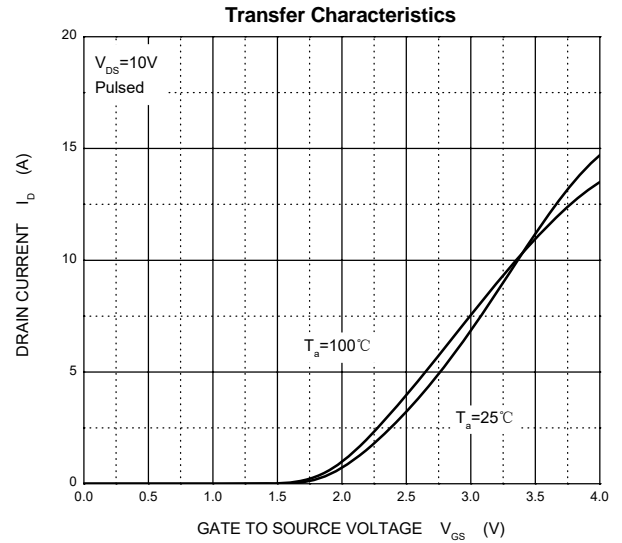
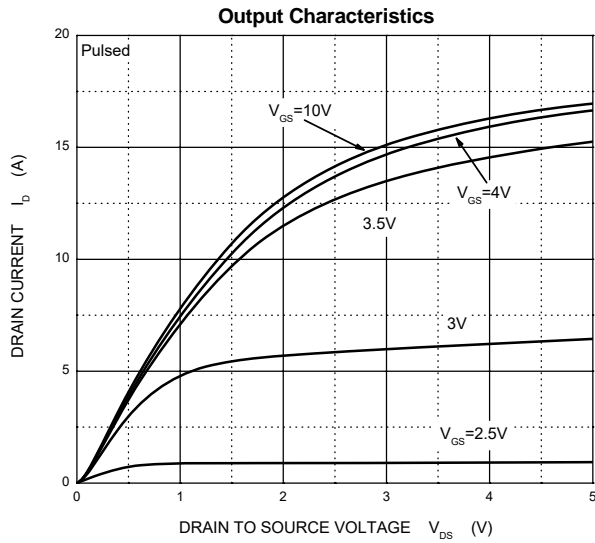

SOT-89-3L Package Outline Dimensions

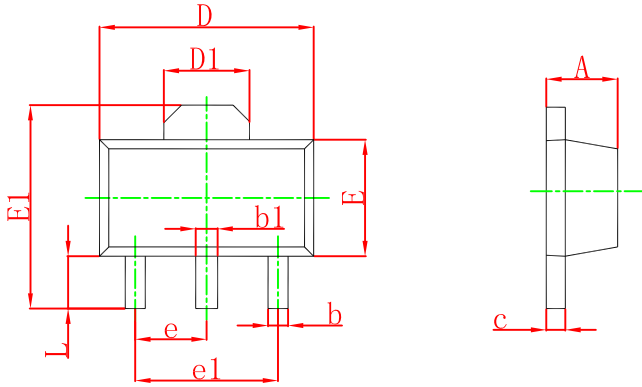

| Symbol | Dimensions In Millimeters | | Dimensions In Inches | |
|--------|---------------------------|-------|----------------------|-------|
| | Min | Max | Min | Max |
| A | 1.400 | 1.600 | 0.055 | 0.063 |
| b | 0.320 | 0.520 | 0.013 | 0.020 |
| b1 | 0.400 | 0.580 | 0.016 | 0.023 |
| c | 0.350 | 0.440 | 0.014 | 0.017 |
| D | 4.400 | 4.600 | 0.173 | 0.181 |
| D1 | 1.550 REF. | | 0.061 REF. | |
| E | 2.300 | 2.600 | 0.091 | 0.102 |
| E1 | 3.940 | 4.250 | 0.155 | 0.167 |
| e | 1.500 TYP. | | 0.060 TYP. | |
| e1 | 3.000 TYP. | | 0.118 TYP. | |
| L | 0.900 | 1.200 | 0.035 | 0.047 |

SOT-89-3L Suggested Pad Layout

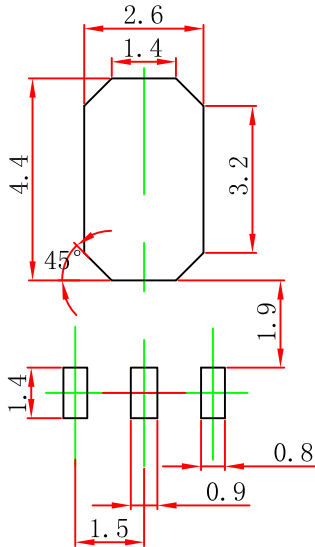

Note:

1. Controlling dimension: in millimeters.
2. General tolerance: $\pm 0.05\text{mm}$.
3. The pad layout is for reference purposes only.

NOTICE

JSCJ reserves the right to make modifications, enhancements, improvements, corrections or other changes without further notice to any product herein. JSCJ does not assume any liability arising out of the application or use of any product described herein.

SOT-89-3L Tape and Reel

SOT-89-3L Embossed Carrier Tape

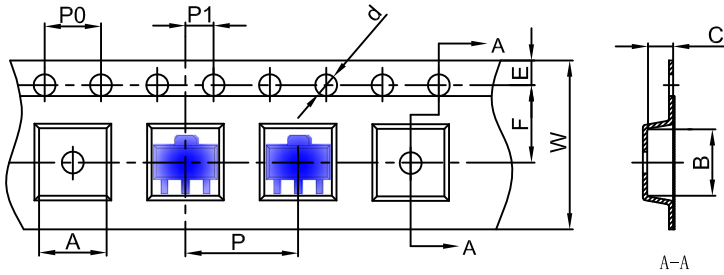

Packaging Description:
 SOT-89-3L parts are shipped in tape. The carrier tape is made from a dissipative (carbon filled) polycarbonate resin. The cover tape is a multilayer film (Heat Activated Adhesive in nature) primarily composed of polyester film, adhesive layer, sealant, and anti-static sprayed agent. These reeled parts in standard option are shipped with 1,000 units per 7" or 18.0 cm diameter reel. The reels are clear in color and is made of polystyrene plastic (anti-static coated).

| Dimensions are in millimeter | | | | | | | | | | |
|------------------------------|------|------|------|-------|------|------|------|------|------|-------|
| Pkg type | A | B | C | d | E | F | P0 | P | P1 | W |
| SOT-89-3L | 4.85 | 4.45 | 1.85 | Ø1.50 | 1.75 | 5.50 | 4.00 | 8.00 | 2.00 | 12.00 |

SOT-89-3L Tape Leader and Trailer

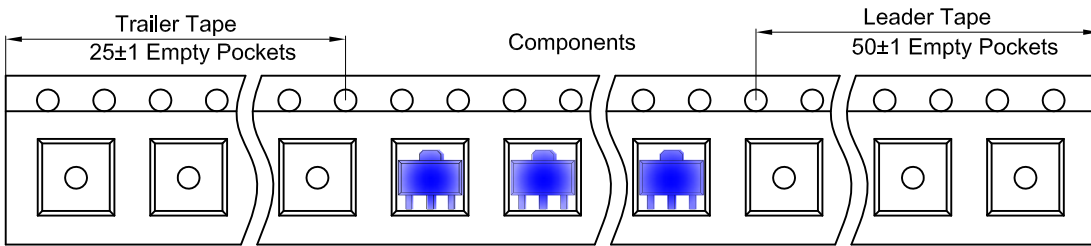

SOT-89-3L Reel

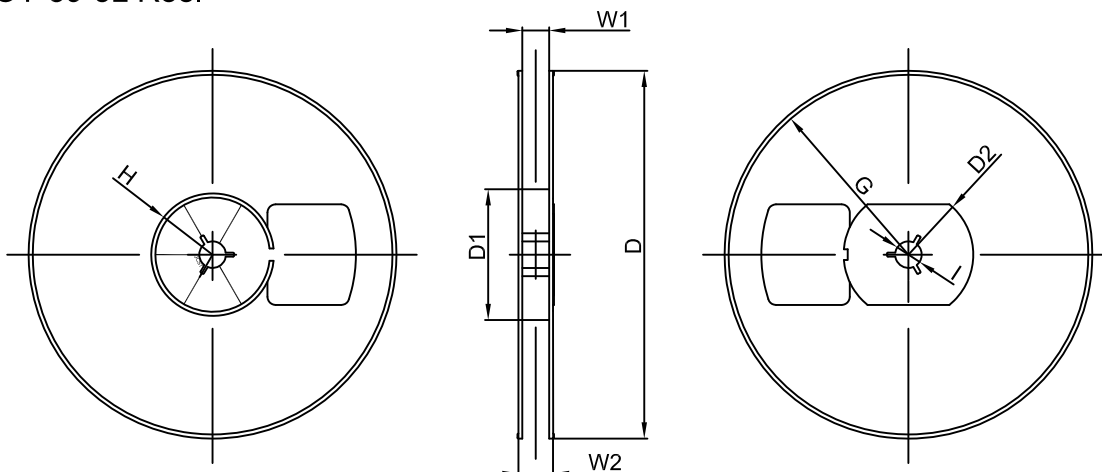

| Dimensions are in millimeter | | | | | | | | |
|------------------------------|---------|-------|--------|--------|--------|--------|-------|-------|
| Reel Option | D | D1 | D2 | G | H | I | W1 | W2 |
| 7" Dia | Ø180.00 | 60.00 | R32.00 | R86.50 | R30.00 | Ø13.00 | 13.20 | 16.50 |

| REEL | Reel Size | Box | Box Size(mm) | Carton | Carton Size(mm) | G.W.(kg) |
|----------|-----------|------------|--------------|------------|-----------------|----------|
| 1000 pcs | 7 inch | 10,000 pcs | 203×203×195 | 40,000 pcs | 438×438×220 | |