



Specification Sheet

P/N: Photocoupler

Customer: _____

Mfg P/N: OR-357

Date: _____

SHENZHEN ORIENT COMPONENTS CO.,LTD.

Block A 3rd Floor No.4 Building, Tian'an Cyber Park, Huangge Rd, LongGang
Dist, Shenzhen, GD

1. Features

- Current transfer ratio(CTR : MIN. 50% at $I_F = 5\text{mA}$, $V_{CE} = 5\text{V}$, $T_a=25\text{ }^\circ\text{C}$)
- High input -output isolation voltage ($V_{ISO}=3,750\text{Vrms}$)
- High collector-emitter voltage ($V_{CEO} = 35\text{V}$)
- SOP-4 package
- $-55\text{ }^\circ\text{C}$ to $115\text{ }^\circ\text{C}$
- RoHS Compliance



2. Instructions

- The OR-357 series device consists of an infrared led, phototransistor detector. They are encapsulated in a 4 pin SOP encapsulation.
- Pin pitch of OR-357 is 2.54mm

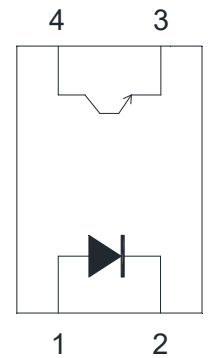

1 Anode 2 Cathode
3 Emitter 4 Collector

3. Application Range

- Hybrid substrates that require high density mounting.
- Programmable controllers
- System appliance, measuring instruments

4. Max Absolute rated Value (Normal Temperature=25°C)

Parameter		Symbol	Rated Value	Unit
Input	Forward Current	I_F	50	mA
	Junction Temperature	T_J	125	$^\circ\text{C}$
	Reverse Voltage	V_R	6	V
	Consume Power	P	100	mW
Output	Collector and emitter Voltage	V_{CEO}	35	V
	Emitter and collector Voltage	V_{ECO}	6	
	Collector Current	I_C	50	mA
	Consume Power	P_C	150	mW
Total Consume Power		P_{tot}	170	mW
*1 Insulation Voltage		V_{iso}	3750	Vrms
Working Temperature		T_{opr}	-55 to + 115	$^\circ\text{C}$
Deposit Temperature		T_{stg}	-55 to + 150	
*2 Soldering Temperature		T_{sol}	260	

- *1. AC Test, 1 minute, humidity = 40~60%
 Insulation test method as below:
 (1) Short circuit both terminals of photocoupler.
 (2) No Current when testing insulation voltage.
 (3) Adding sine wave voltage when testing.

*2. soldering time is 10 seconds.

5. Opto-electronic Characteristics

Parameter		Symbol	Condition	Min	Typ.*	Max	Unit
Input	Forward Current	V_F	$I_F=20mA$	---	1.2	1.4	V
	Reverse Voltage	I_R	$V_R=4V$	---	---	10	μA
	Collector capacitance	C_t	$V=0, f=1KHz$	---	30	250	pF
Output	Collector to emitter Current	I_{CEO}	$V_{CE}=20V, I_F=0mA$	---	---	100	nA
	Collector and Emitter attenuation Voltage	BV_{CEO}	$I_C=0.1mA, I_F=0mA$	35	---	---	V
	Emitter and Collector attenuation Voltage	BV_{ECO}	$I_E=0.01mA, I_F=0mA$	6	---	---	V
Transforming Characteristics	*1.Current conversion ratio	CTR	$I_F=5mA, V_{CE}=5V$	50	---	600	%
	Collector Current	I_C		2.5	---	30	mA
	Collector and Emitter Saturation Voltage	$V_{CE(sat)}$	$I_F=20mA, I_C=1mA$	---	---	0.2	V
	Insulation Impedance	R_{iso}	DC500V 40~60%R.H.	5×10^{10}	1×10^{11}	---	Ω
	Floating Capacitance	C_f	$V=0, f=1MHz$	---	0.6	1	pF
	Response Time	t_r	$V_{CC}=2V, I_C=2mA, R_L=100\Omega$	---	4	18	μs
	Descend Time	t_f		---	3	18	μs

- Current Conversion Ratio = $I_C / I_F \times 100\%$

6. Rank table of current transfer ratio CTR (tolerance:±3%)

CTR Rank	Min.	Max.	Condition
A	80	160	$I_F=5mA, V_{CE}=5V, T_a=25^{\circ}C$
B	130	260	
C	200	400	
D	300	600	
E	50	150	
No mark	50	600	

7. Naming Rule

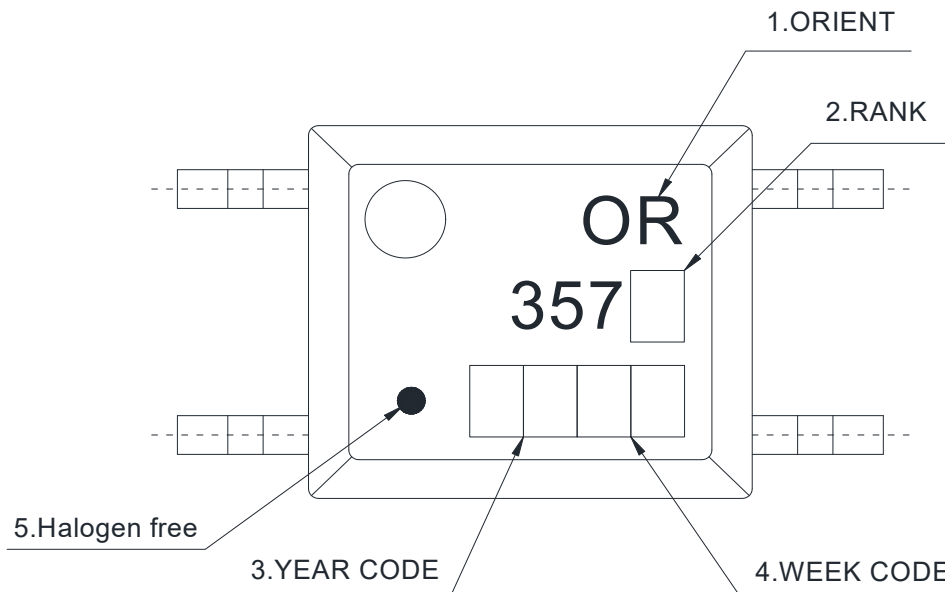

1. ORIENT
2. Rank shall be or shall not be marked.
3. Year Code, Example : 2010 = 10
4. Work Week Ranging from '01' to '53'
5. "●" indicates halogen free option.

8. Outer Dimension

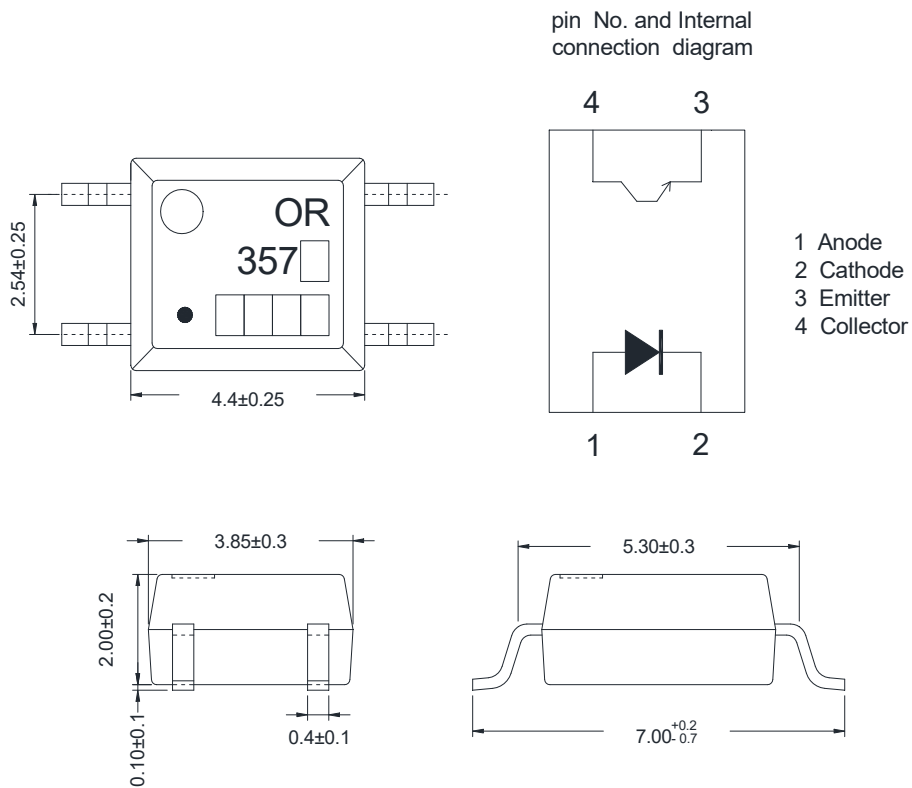

9. Recommended Foot Print Patterns (Mount Pad)

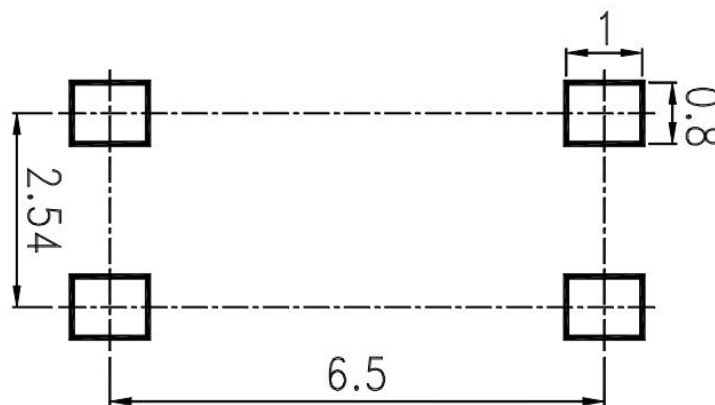

unit : mm

10. Taping Dimensions

(1) OR-357-TP

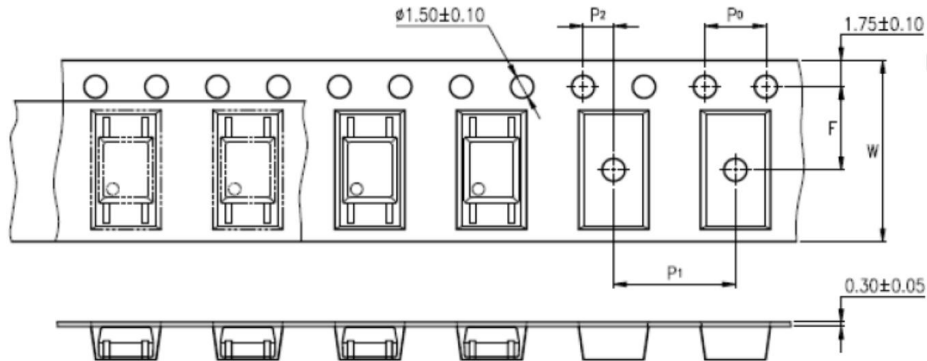

(2) OR-357-TP1

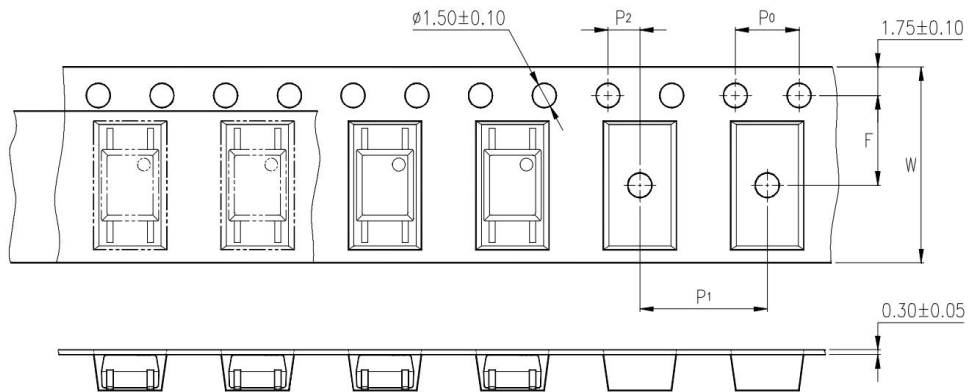

Description	Symbol	Dimension in mm(inch)
Tape wide	W	12±0.3 (0.472)
Pitch of sprocket holes	P0	4±0.1 (0.157)
Distance of compartment	F	5.5±0.1 (0.217)
	P2	2±0.1 (0.079)
Distance of compartment to compartment	P1	8±0.1 (0.315)

Package Type	OR-357 series
Quantities(pcs)	3000

11. Temperature Profile Of Soldering

(1) IR Reflow soldering (JEDEC-STD-020C compliant)

One time soldering reflow is recommended within the condition of temperature and time profile shown below. Do not solder more than three times.

Profile item	Conditions
Preheat	
- Temperature Min (T Smin)	150°C
- Temperature Max (T Smax)	200°C
- Time (min to max) (ts)	90±30 sec
Soldering zone	
- Temperature (TL)	217°C
- Time (t L)	60 sec
Peak Temperature	260°C
Ramp-up rate	3°C / sec max.
3°C / sec max.	3~6°C / sec

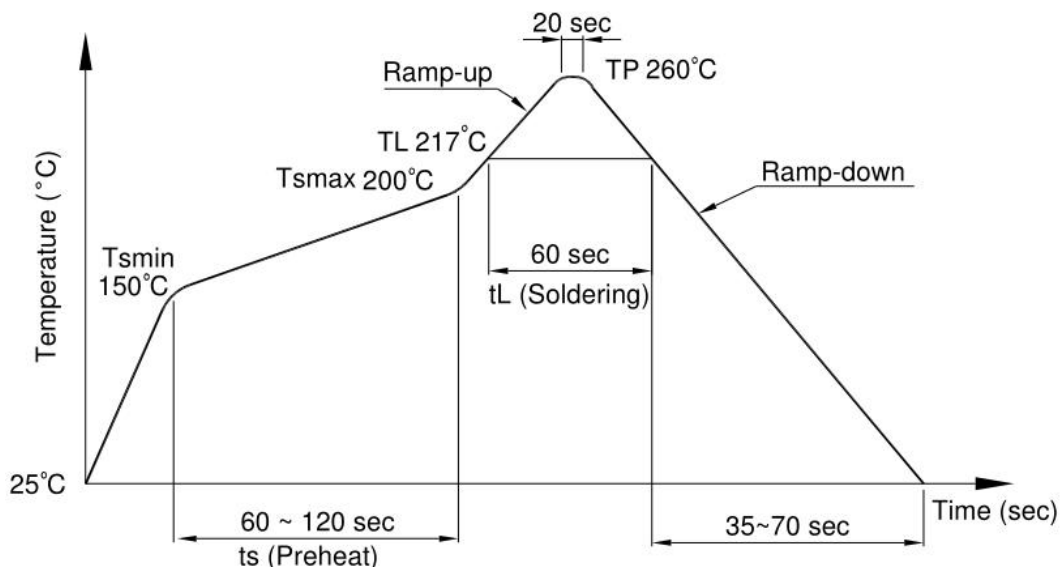

(2) Wave soldering (JEDEC22A111 compliant)

One time soldering is recommended within the condition of temperature.

Temperature	260+0/-5°C
Time	10 sec
Preheat temperature	5 to 140°C
Preheat time	30 to 80 sec

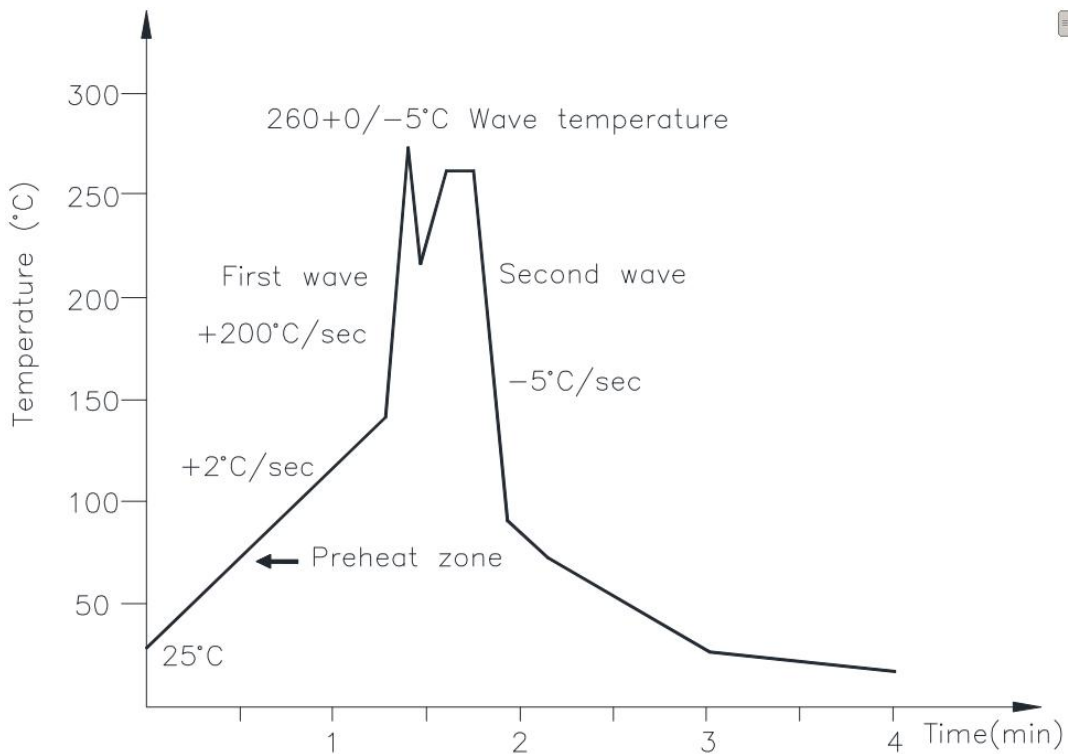

(3) Hand soldering by soldering iron

Allow single lead soldering in every single process. One time soldering is recommended.

Temperature	380+0/-5°C
Time	3 sec max

12. Characteristics Curve

Fig.1 Forward Current vs. Ambient Temperature

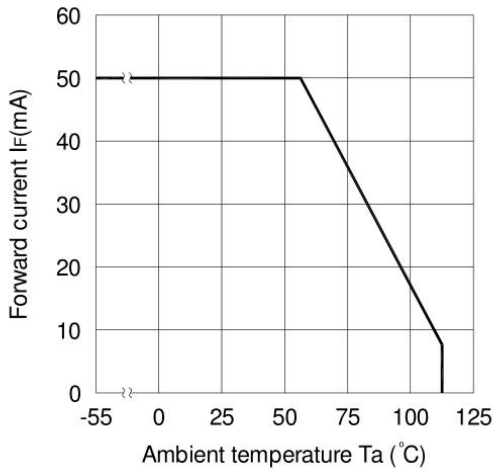

Fig.2 Collector Power Dissipation vs. Ambient Temperature

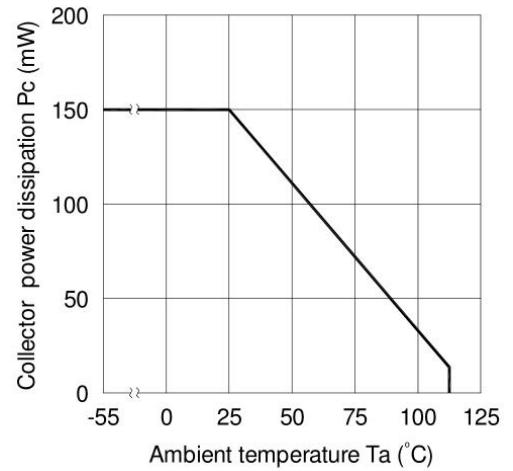

Fig.3 Collector-emitter Saturation Voltage vs. Forward Current

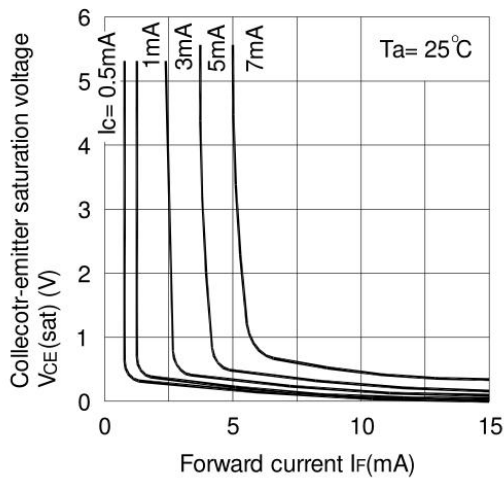

Fig.4 Forward Current vs. Forward Voltage

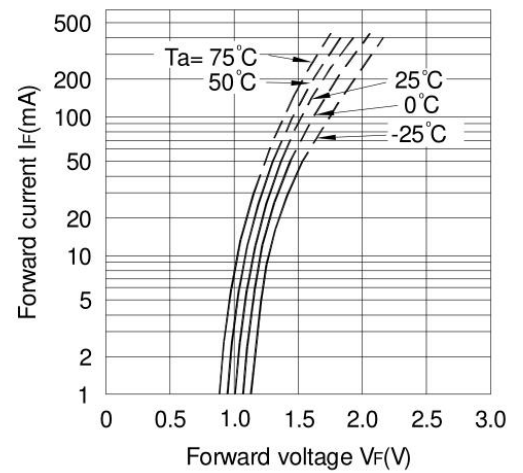

Fig.5 Current Transfer Ratio vs. Forward Current

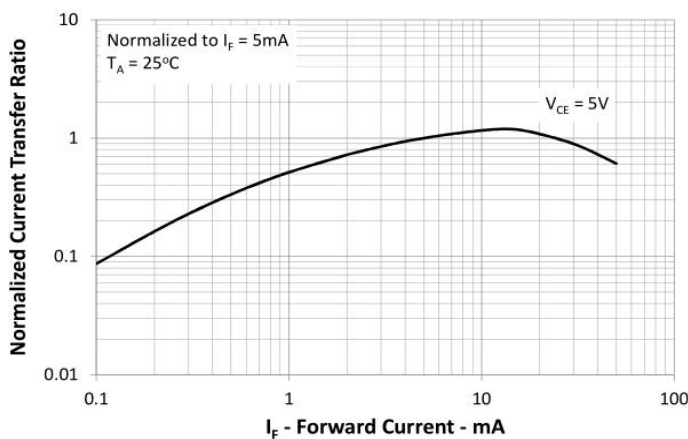

Fig.6 Collector Current vs. Collector-emitter Voltage

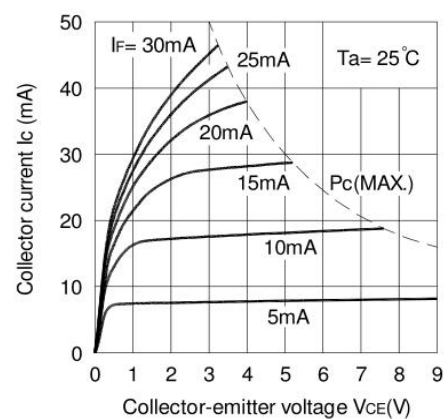

Fig.7 Relative Current Transfer Ratio vs. Ambient Temperature

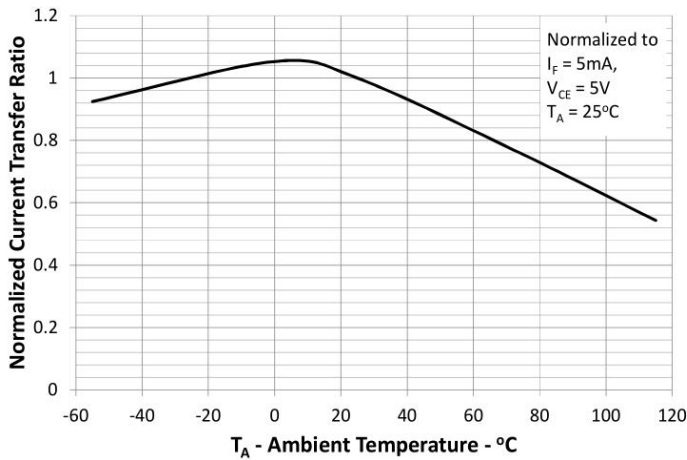

Fig.8 Collector-emitter Saturation Voltage vs. Ambient Temperature

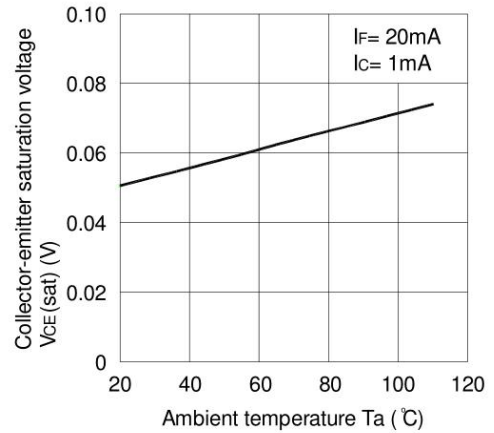

Fig.9 Collector Dark Current vs. Ambient Temperature

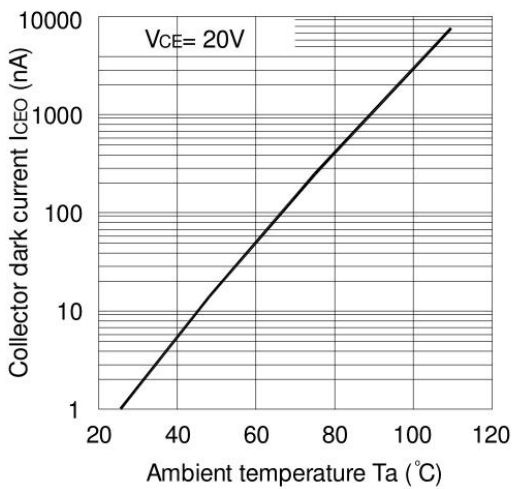

Fig.10 Response Time vs. Load Resistance

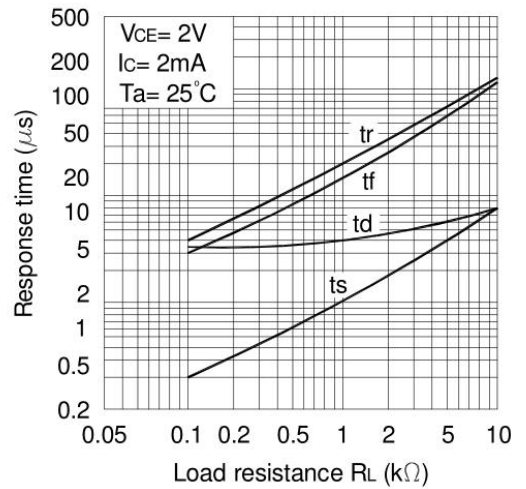
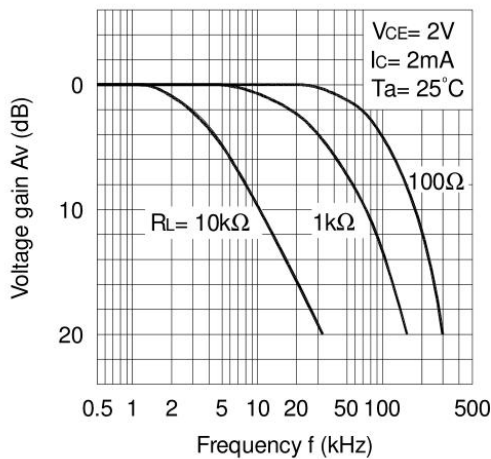
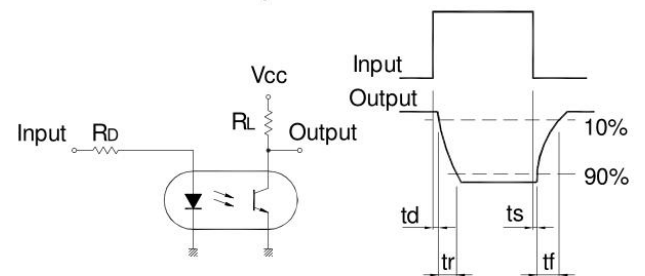

Fig.11 Frequency Response



Test Circuit for Response Time



Test Circuit for Frequency Response

