



# Approval Sheet

## Customer Information

Customer			
Part Name			
Part No.			
Model No.			
<b>Company</b>	<b>Purchase</b>	<b>R&amp;D</b>	

## Vendor Information

Name	SFI Electronics Technology Inc.
Part Name	Chip TVS
Part No.	SFI0805ML390C-LF
Lot No.	

## SFI Electronics Technology Inc.

ADDRESS : No.6, Lane 340, Shan-Ying Road, Guishan, Tao Yuan, Taiwan

TEL : 886-3-3506998 FAX : 886-3-3507689 E-mail : sfi@sfi.com.tw

Quality Control	Document Control	Business Issue	
 <p>ISO 9001:2008 ISO 14001:2004 ISO/TS 16949:2009 Management System www.tuv.com ID 1100008833</p>	REV : K	Prepared	Check
			

Part No.	<b>SFI0805ML390C-LF</b>	Document No.	<b>AS-RD0805MC092-LF</b>	REV.	<b>K</b>
<a href="http://www.sfi.com.tw">http://www.sfi.com.tw</a> E-mail : <a href="mailto:sfi@sfi.com.tw">sfi@sfi.com.tw</a> TEL : 886-3-3506998 FAX : 886-3-3507689 - 1 -					



**PART NO. SFI0805ML390C-LF**

**1.1 Technology Data**

	Symbol	Value	Unit
Maximum allowable continuous AC voltage at 50-60Hz	$V_{RMS}$	25	V
Maximum allowable continuous DC voltage	$V_{DC}$	30	V
Varistor breakdown voltage	$V_V$	39(35.1~42.9)	V
Maximum allowable clamping voltage	$V_C$	65	V
Maximum peak current	$I_{Peak}$	100	A

**1.2 Reference Data**

Maximum energy absorption	E	0.3	J
Typical capacitance value measured at 1KHz	C	200	pF
Response time	$T_{rise}$	< 1	ns
Leakage current at $V_V \times 80\%$ (at initial state)	$I_{VV}$	< 50	$\mu A$
Leakage current at $V_V \times 80\%$ (after surge test)	$I_{VVA}$	< 200	$\mu A$
Operation ambient temperature	$T_{OPT}$	-50~+85	$^{\circ}C$
Storage temperature range	$T_{STG}$	-50~+125	$^{\circ}C$

**1.3 Other Data**

Body	ZnO
End termination	Ag/Ni/Sn
Packaging	Reel
Complies with standard	IEC61000-4-5
Complies with RoHs standard	Yes
Lead content	< 1000 ppm
Marking	None

Notes :

- \* 1 The varistor breakdown voltage was measured at 1mA.
- \* 2 The clamping voltage was measured at 8/20 $\mu s$  standard current, 0805(1A).
- \* 3 The peak current was tested at 8/20 $\mu s$  waveform.
- \* 4 The capacitance and energy values only for customer reference, it's not formal specification.
- \* 5 The components shall be employed within 1 year, in the nitrogen condition.

Part No.	<b>SFI0805ML390C-LF</b>	Document No.	<b>AS-RD0805MC092-LF</b>	REV.	<b>K</b>
<a href="http://www.sfi.com.tw">http://www.sfi.com.tw</a> E-mail : <a href="mailto:sfi@sfi.com.tw">sfi@sfi.com.tw</a> TEL : 886-3-3506998 FAX : 886-3-3507689 - 2 -					



### 2. Size

<b>Model</b>	<b>0805(2012)</b>
Length(L)	2.00±0.20
Width(W)	1.25±0.15
Thickness(T)	1.20 max.
Termination(a)	0.40±0.20

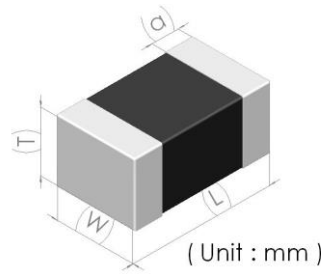

### 3. Surge Wave Form

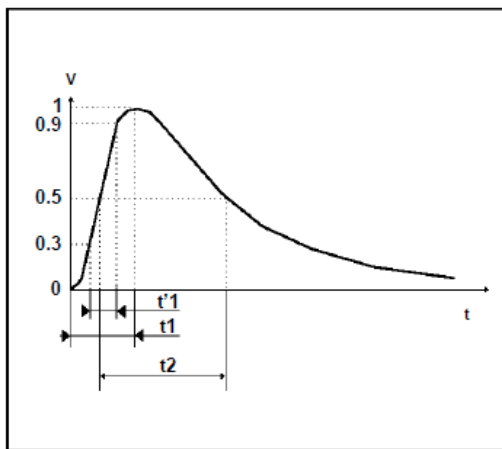

### IEC61000-4-5 Standards

SEVERITY LEVEL	t1 (=1.67t'1)	t2
1	8µs	20µs
2	10µs	1000µs

8/20µs waveform current

### 4. Environment Reliability Test

Characteristic	Test Method and Description			
High Temperature Storage	The specimen shall be subjected to 125±2°C for 1000±2 hours without load and then stored at room temperature and normal humidity for one or two hours. The change of varistor voltage shall be within 10%.			
Temperature Cycle	The temperature cycle of specified temperature shall be repeated five times and then stored at room temperature and normal humidity for one or two hours. The change of varistor voltage shall be within 10% and mechanical damage shall be examined.	Step	Temperature	Period
		1	-40±3°C	30±3min
		2	room temperature	1 hour
		3	125±3°C	30±3min
4	room temperature	1 hour		
High Temperature Load	After being continuously applied the maximum allowable voltage at 85±2°C for 1000±2 hours, the specimen shall be stored at room temperature and normal humidity for one or two hours. The change of varistor voltage shall be within 10%.			
Damp Heat Load/ Humidity Load	The specimen should be subjected to 40±2°C and 90~95% RH, the maximum allowable voltage applied for 1000±2 hours and then stored at room temperature and normal humidity for one or two hours. The change of varistor voltage shall be within 10%.			
Low Temperature Storage	The specimen should be subjected to -40±2°C for 1000±2 hours without load and then stored at room temperature and normal humidity for one or two hours. The change of varistor voltage shall be within 10%.			

<b>Part No.</b>	<b>SFI0805ML390C-LF</b>	<b>Document No.</b>	<b>AS-RD0805MC092-LF</b>	<b>REV.</b>	<b>K</b>
<a href="http://www.sfi.com.tw">http://www.sfi.com.tw</a> E-mail : <a href="mailto:sfi@sfi.com.tw">sfi@sfi.com.tw</a> TEL : 886-3-3506998    FAX : 886-3-3507689    - 3 -					

### 5. Soldering Recommendations

#### 5.1 Recommended solder pad layout

(Unit : mm)

	A	B	C
0805	1.0~1.5	1.0~1.5	1.2~1.5

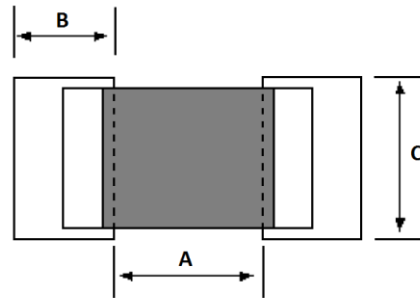

#### 5.2 The SIR test of the solder paste shall be done (Based on JIS-Z-3284)

#### 5.3 Steel plate and foot distance printing

Foot distance printing (mm)	Steel plate thickness (mm)
$\geq 0.65\text{mm}$	0.18mm
0.50~0.65mm	0.15mm
0.40~0.50mm	0.12mm
$\leq 0.40\text{mm}$	0.10mm

#### 5.4 The IR reflow and temperature of soldering for Pb free process

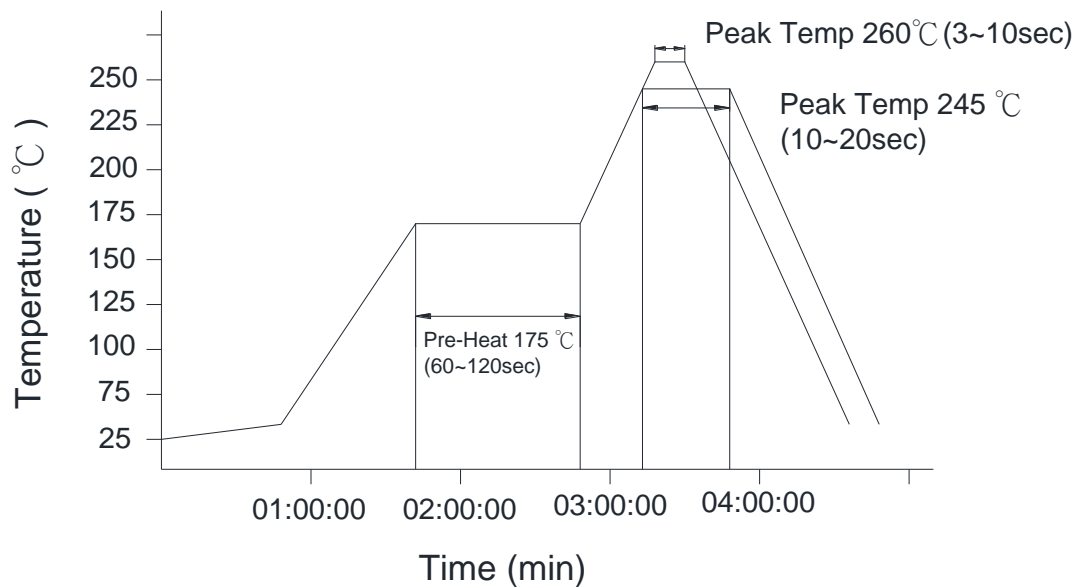

#### ☆ IR reflow Pb free process suggestion profile

- (1) The solder recommend is Sn96.5/Ag3.5 and thickness recommend as shown in table 5.3
- (2) Ramp-up rate (217°C to peak) +3°C/second max.
- (3) Temp. maintain at 175±25°C 180 seconds max.
- (4) Temp. maintain above 217°C 60~150 seconds

Part No.	<b>SFI0805ML390C-LF</b>	Document No.	<b>AS-RD0805MC092-LF</b>	REV.	<b>K</b>
<a href="http://www.sfi.com.tw">http://www.sfi.com.tw</a> E-mail : <a href="mailto:sfi@sfi.com.tw">sfi@sfi.com.tw</a> TEL : 886-3-3506998    FAX : 886-3-3507689    - 4 -					



(5) Peak temperature range 245 +20/-10°C within 5°C of actually peak temperature ( $t_p$ ) 10~20 seconds

(6) Ramp down rate -6°C/second max.

※Perform adequate test in advance as the reflow temperature profile will vary according to the conditions of the manufacturing process and the specification of the reflow furnace.

5.5 Resistance to soldering heat and high temperature resistance : 260°C, 10sec 3 times

### 5.6 Hand soldering

In hand soldering of the varistors, large temperature gradient between preheated the varistors and the tip of soldering iron may cause electrical failures and mechanical damages such as cracking or breaking of the devices. The soldering shall be carefully controlled and carried out, so that the temperature gradient is kept minimum with following recommended conditions for hand soldering.

#### 5.6.1 Recommended soldering condition 1 (with preheating)

(1) Solder

**0.12~0.18mm** thread solder (Sn96.5:Ag3.5) with soldering flux in the core  
rosin-based and non-activated flux is recommended.

(2) Preheating

The varistors shall be preheated so that temperature gradient between the devices and the tip of soldering iron is 150°C or below.

(3) Soldering iron

Rated power of 20W max. with 3mm soldering tip in diameter

Temperature of soldering iron tip 380°C max., 3~5sec (The required amount of solder shall be melted in advance on the soldering tip.)

(4) Cooling

After soldering, the varistors shall be cooled gradually at room ambient temperature.

#### 5.6.2 Recommended soldering condition 2 (without preheating)

(1) Solder iron tip shall not directly touch to ceramic dielectrics.

(2) Solder iron tip shall be fully preheated before soldering while soldering iron tip to the external electrode of varistors.

### 5.7 Post soldering cleaning

5.7.1 Residues of corrosive soldering fluxes on the PC board after cleaning may greatly have influences on the electrical characteristic and the reliability (such as humidity resistance) of the varistors which have been mounted on the board. It shall be confirmed that the characteristic and the reliability of the devices are not affected by the applied cleaning conditions.

5.7.2 When an ultrasonic cleaning is applied to the mounted varistors on PC boards. Following conditions are recommended for preventing failures or damages of the devices due to the large vibration energy and the resonance conditions caused by the ultrasonic waves.

(1) Frequency 29MHz max.

(2) Radiated power 20W/liter max.

(3) Period 5 minutes max.

Part No.	<b>SFI0805ML390C-LF</b>	Document No.	<b>AS-RD0805MC092-LF</b>	REV.	<b>K</b>
<a href="http://www.sfi.com.tw">http://www.sfi.com.tw</a> E-mail : <a href="mailto:sfi@sfi.com.tw">sfi@sfi.com.tw</a> TEL : 886-3-3506998 FAX : 886-3-3507689 - 5 -					

### 6. Packaging Specification

6.1 Carrier tape and transparent cover tape should be heat-sealed to carry the products, and the reel should be used to reel the carrier tape.

6.2 The adhesion of the heat-sealed cover tape shall be 40 +20/-15 grams.

6.3 Both the head and the end portion of the taping shall be empty for reel package and SMT auto-pickup machine. And a normal paper tape shall be connected in the head of taping for the operator to handle.

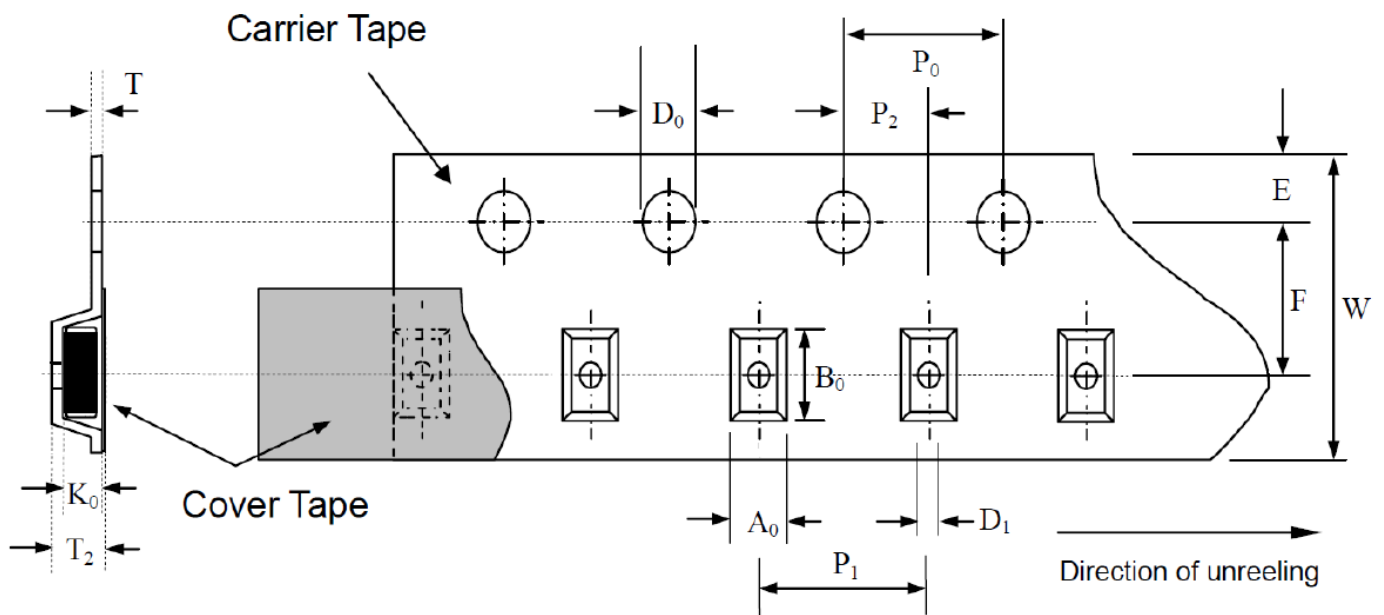

(Unit : mm)

Symbol	$A_0$ $\pm 0.10$	$B_0$ $\pm 0.10$	$K_0$ $\pm 0.10$	$T$ $\pm 0.05$	$T_2$ $\pm 0.05$	$D_0$ $+0.10$ $-0.00$	$D_1$ $\pm 0.05$	$P_1$ $\pm 0.10$	$P_2$ $\pm 0.05$	$P_0$ $\pm 0.05$	$W$ $\pm 0.20$	$E$ $\pm 0.10$	$F$ $\pm 0.05$
<b>0805</b>	1.50	2.30	1.30	0.22	1.52	1.50	1.00	4.00	2.00	4.00	8.00	1.75	3.50



### 7. Reel Dimension

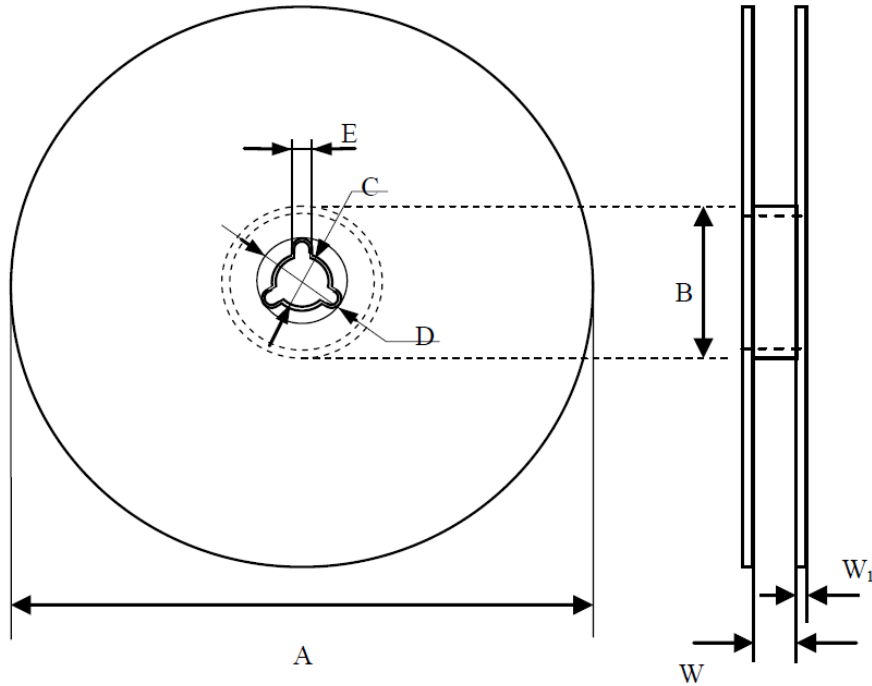

(Unit : mm)

Symbol	A	B	C	D	E	W	W <sub>1</sub>
0805	178.0±1.0	60.0±0.5	13.0±0.2	21.0±0.2	2.0±0.5	9.0±0.5	1.5±0.1

### 8. Standard Packaging

Size	0805
Pcs	3000

Part No.	<b>SFI0805ML390C-LF</b>	Document No.	<b>AS-RD0805MC092-LF</b>	REV.	<b>K</b>
<a href="http://www.sfi.com.tw">http://www.sfi.com.tw</a> E-mail : <a href="mailto:sfi@sfi.com.tw">sfi@sfi.com.tw</a> TEL : 886-3-3506998    FAX : 886-3-3507689    - 7 -					