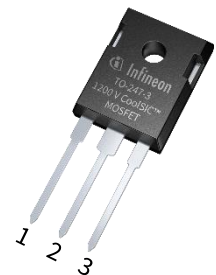
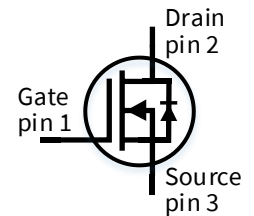


# IMW120R030M1H

## CoolSiC™ 1200V SiC Trench MOSFET Silicon Carbide MOSFET

### Features

- Very low switching losses
- Threshold-free on state characteristic
- Wide gate-source voltage range
- Benchmark gate threshold voltage,  $V_{GS(th)} = 4.5V$
- 0V turn-off gate voltage for easy and simple gate drive
- Fully controllable dV/dt
- Robust body diode for hard commutation
- Temperature independent turn-off switching losses



### Benefits

- Efficiency improvement
- Enabling higher frequency
- Increased power density
- Cooling effort reduction
- Reduction of system complexity and cost

### Potential applications

- Energy generation
  - Solar string inverter and solar optimizer
- Industrial power supplies
  - Industrial UPS
  - Industrial SMPS
- Infrastructure – Charge
  - Charger



### Product validation

Qualified for industrial applications according to the relevant tests of JEDEC 47/20/22

**Table 1 Key Performance and Package Parameters**

Type	$V_{DS}$	$I_D$ <small><math>T_C = 25^\circ C, R_{th(j-c,max)}</math></small>	$R_{DS(on)}$ <small><math>T_{vj} = 25^\circ C, I_D = 25A, V_{GS} = 18V</math></small>	$T_{vj,max}$	Marking	Package
IMW120R030M1H	1200V	56A	30m $\Omega$	175 $^\circ C$	12M1H030	PG-TO247-3

## Table of contents

<b>Features .....</b>	<b>1</b>
<b>Benefits .....</b>	<b>1</b>
<b>Potential applications .....</b>	<b>1</b>
<b>Product validation .....</b>	<b>1</b>
<b>Table of contents .....</b>	<b>2</b>
<b>1 Maximum ratings .....</b>	<b>3</b>
<b>2 Thermal resistances .....</b>	<b>4</b>
<b>3 Electrical Characteristics .....</b>	<b>5</b>
3.1 Static characteristics .....	5
3.2 Dynamic characteristics .....	6
3.3 Switching characteristics .....	7
<b>4 Electrical characteristic diagrams .....</b>	<b>8</b>
<b>5 Package drawing .....</b>	<b>14</b>
<b>6 Test conditions .....</b>	<b>15</b>
<b>Revision history .....</b>	<b>16</b>

## Maximum ratings

## 1 Maximum ratings

For optimum lifetime and reliability, Infineon recommends operating conditions that do not exceed 80% of the maximum ratings stated in this datasheet.

**Table 2 Maximum ratings**

Parameter	Symbol	Value	Unit
Drain-source voltage, $T_{vj} \geq 25^\circ\text{C}$	$V_{DSS}$	1200	V
DC drain current for $R_{th(j-c,max)}$ , limited by $T_{vj,max}$ , $V_{GS} = 18\text{V}$ , $T_C = 25^\circ\text{C}$	$I_D$	56	A
$T_C = 100^\circ\text{C}$		45	
Pulsed drain current, $t_p$ limited by $T_{vj,max}$ , $V_{GS} = 18\text{V}$	$I_{D,pulse}^1$	150	A
DC body diode forward current for $R_{th(j-c,max)}$ , limited by $T_{vj,max}$ , $V_{GS} = 0\text{V}$	$I_{SD}$	56	A
$T_C = 100^\circ\text{C}$		35	
Pulsed body diode current, $t_p$ limited by $T_{vj,max}$	$I_{SD,pulse}^1$	150	A
Gate-source voltage <sup>2</sup>			
Max transient voltage, < 1% duty cycle	$V_{GS}$	-7... 23	V
Recommended turn-on gate voltage	$V_{GS,on}$	15... 18	
Recommended turn-off gate voltage	$V_{GS,off}$	0	
Short-circuit withstand time $V_{DD} = 800\text{V}$ , $V_{DS,peak} < 1200\text{V}$ , $V_{GS,on} = 15\text{V}$ , $T_{j,start} = 25^\circ\text{C}$	$t_{SC}$	3	$\mu\text{s}$
Power dissipation, limited by $T_{vj,max}$	$P_{tot}$	227	W
$T_C = 100^\circ\text{C}$		114	
Virtual junction temperature	$T_{vj}$	-55... 175	$^\circ\text{C}$
Storage temperature	$T_{stg}$	-55... 150	$^\circ\text{C}$
Soldering temperature, wave soldering only allowed at leads, 1.6mm (0.063 in.) from case for 10 s	$T_{sold}$	260	$^\circ\text{C}$
Mounting torque, M3 screw Maximum of mounting processes: 3	$M$	0.6	Nm

<sup>1</sup> verified by design

<sup>2</sup> **Important note:** The selection of positive and negative gate-source voltages impacts the long-term behavior of the device. The design guidelines described in [Application Note AN2018-09](#) must be considered to ensure sound operation of the device over the planned lifetime.

## 2 Thermal resistances

Table 3

Parameter	Symbol	Conditions	Value			Unit
			min.	typ.	max.	
MOSFET/body diode thermal resistance, junction – case	$R_{th(j-c)}$		-	0.51	0.66	K/W
Thermal resistance, junction – ambient	$R_{th(j-a)}$	leaded	-	-	62	K/W

### 3 Electrical Characteristics

#### 3.1 Static characteristics

**Table 4 Static characteristics (at  $T_{vj} = 25^{\circ}\text{C}$ , unless otherwise specified)**

Parameter	Symbol	Conditions	Value			Unit
			min.	typ.	max.	
Drain-source on-state resistance	$R_{DS(on)}$	$V_{GS} = 18\text{V}, I_D = 25\text{A},$ $T_{vj} = 25^{\circ}\text{C}$	-	30	42	m $\Omega$
		$T_{vj} = 100^{\circ}\text{C}$	-	38	-	
		$T_{vj} = 175^{\circ}\text{C}$	-	57	-	
		$V_{GS} = 15\text{V}, I_D = 25\text{A},$ $T_{vj} = 25^{\circ}\text{C}$	-	42	56	
Body diode forward voltage	$V_{SD}$	$V_{GS} = 0\text{V}, I_{SD} = 25\text{A}$ $T_{vj} = 25^{\circ}\text{C}$	-	4.1	5.2	V
		$T_{vj} = 100^{\circ}\text{C}$	-	4.0	-	
		$T_{vj} = 175^{\circ}\text{C}$	-	3.9	-	
Gate-source threshold voltage	$V_{GS(th)}$	<i>(tested after 1 ms pulse at</i> $V_{GS} = 20\text{V})$ $I_D = 10\text{mA}, V_{DS} = V_{GS}$ $T_{vj} = 25^{\circ}\text{C}$	3.5	4.5	5.7	V
		$T_{vj} = 175^{\circ}\text{C}$	-	3.6	-	
Zero gate voltage drain current	$I_{DSS}$	$V_{GS} = 0\text{V}, V_{DS} = 1200\text{V}$ $T_{vj} = 25^{\circ}\text{C}$	-	1.1	200	$\mu\text{A}$
		$T_{vj} = 175^{\circ}\text{C}$	-	3.4	-	
Gate-source leakage current	$I_{GSS}$	$V_{GS} = 23\text{V}, V_{DS} = 0\text{V}$	-	-	120	nA
		$V_{GS} = -7\text{V}, V_{DS} = 0\text{V}$	-	-	-120	nA
Transconductance	$g_{fs}$	$V_{DS} = 20\text{V}, I_D = 25\text{A}$	-	14	-	S
Internal gate resistance	$R_{G,int}$	$f = 1\text{MHz}, V_{AC} = 25\text{mV}$	-	3	-	$\Omega$

## Electrical Characteristics

## 3.2 Dynamic characteristics

Table 5 Dynamic characteristics (at  $T_{vj} = 25^{\circ}\text{C}$ , unless otherwise specified)

Parameter	Symbol	Conditions	Value			Unit
			min.	typ.	max.	
Input capacitance	$C_{iss}$	$V_{DD} = 800\text{V}, V_{GS} = 0\text{V},$ $f = 1\text{MHz}, V_{AC} = 25\text{mV}$	-	2120	-	pF
Output capacitance	$C_{oss}$		-	116	-	
Reverse capacitance	$C_{rss}$		-	13	-	
$C_{oss}$ stored energy	$E_{oss}$		-	44	-	$\mu\text{J}$
Total gate charge	$Q_G$	$V_{DD} = 800\text{V}, I_D = 25\text{A},$ $V_{GS} = 0/18\text{V}, \text{turn-on pulse}$	-	63	-	nC
Gate to source charge	$Q_{GS,pl}$		-	18	-	
Gate to drain charge	$Q_{GD}$		-	15	-	

## Electrical Characteristics

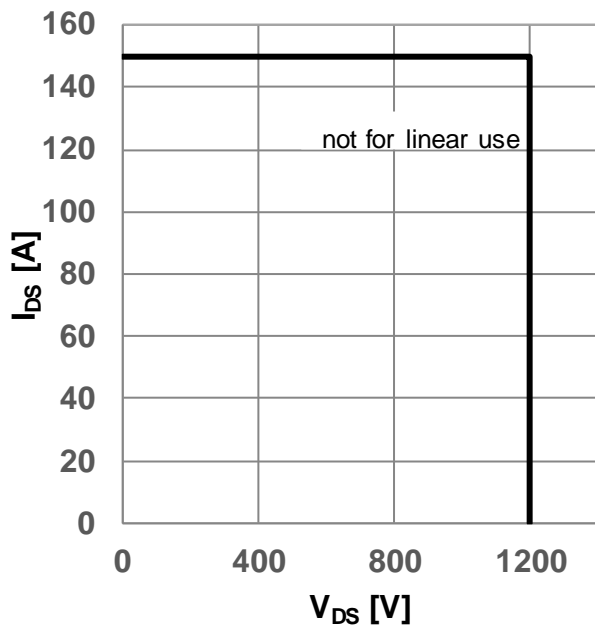
## 3.3 Switching characteristics

Table 6 Switching characteristics, Inductive load <sup>4</sup>

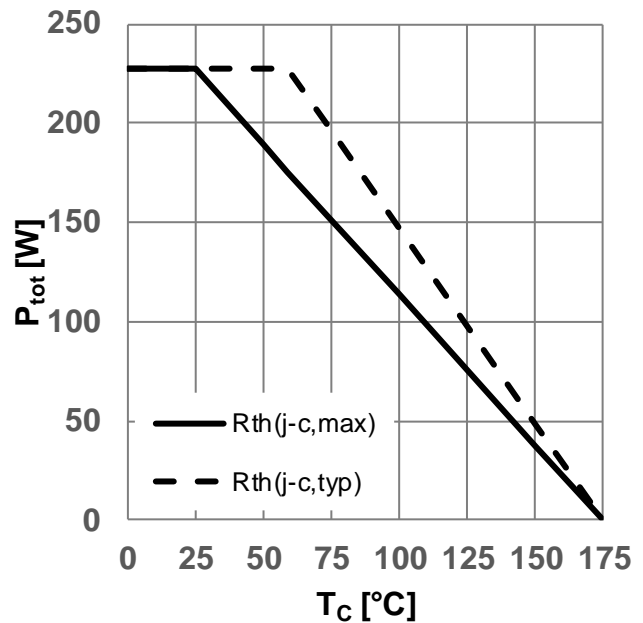
Parameter	Symbol	Conditions	Value			Unit
			min.	typ.	max.	
<b>MOSFET Characteristics, <math>T_{vj} = 25^{\circ}\text{C}</math></b>						
Turn-on delay time	$t_{d(on)}$	$V_{DD} = 800\text{V}, I_D = 25\text{A},$ $V_{GS} = 0/18\text{V}, R_{G,ext} = 2\Omega,$ $L_{\sigma} = 40\text{nH},$ diode: body diode at $V_{GS} = 0\text{V}$ see Fig. E	-	7	-	ns
Rise time	$t_r$		-	19	-	
Turn-off delay time	$t_{d(off)}$		-	17	-	
Fall time	$t_f$		-	13	-	
Turn-on energy	$E_{on}$		-	366	-	$\mu\text{J}$
Turn-off energy	$E_{off}$		-	80	-	
Total switching energy	$E_{tot}$	-	446	-		
<b>Body Diode Characteristics, <math>T_{vj} = 25^{\circ}\text{C}</math></b>						
Diode reverse recovery charge	$Q_{rr}$	$V_{DD} = 800\text{V}, I_{SD} = 25\text{A},$ $V_{GS}$ at diode = $0\text{V},$ $di_f/dt = 1000\text{A}/\mu\text{s},$ $Q_{rr}$ includes also $Q_C,$ see Fig. C	-	320	-	nC
Diode peak reverse recovery current	$I_{rrm}$		-	10	-	A
<b>MOSFET Characteristics, <math>T_{vj} = 175^{\circ}\text{C}</math></b>						
Turn-on delay time	$t_{d(on)}$	$V_{DD} = 800\text{V}, I_D = 25\text{A},$ $V_{GS} = 0/18\text{V}, R_{G,ext} = 2\Omega,$ $L_{\sigma} = 40\text{nH},$ diode: body diode at $V_{GS} = 0\text{V}$ see Fig. E	-	7	-	ns
Rise time	$t_r$		-	46	-	
Turn-off delay time	$t_{d(off)}$		-	17	-	
Fall time	$t_f$		-	13	-	
Turn-on energy	$E_{on}$		-	487	-	$\mu\text{J}$
Turn-off energy	$E_{off}$		-	95	-	
Total switching energy	$E_{tot}$	-	582	-		
<b>Body Diode Characteristics, <math>T_{vj} = 175^{\circ}\text{C}</math></b>						
Diode reverse recovery charge	$Q_{rr}$	$V_{DD} = 800\text{V}, I_{SD} = 25\text{A},$ $V_{GS}$ at diode = $0\text{V},$ $di_f/dt = 1000\text{A}/\mu\text{s},$ $Q_{rr}$ includes also $Q_C,$ see Fig. C	-	401	-	nC
Diode peak reverse recovery current	$I_{rrm}$		-	14	-	A

<sup>4</sup> The chip technology was characterized up to 200 kV/ $\mu\text{s}$ . The measured  $dV/dt$  was limited by measurement test setup and package.

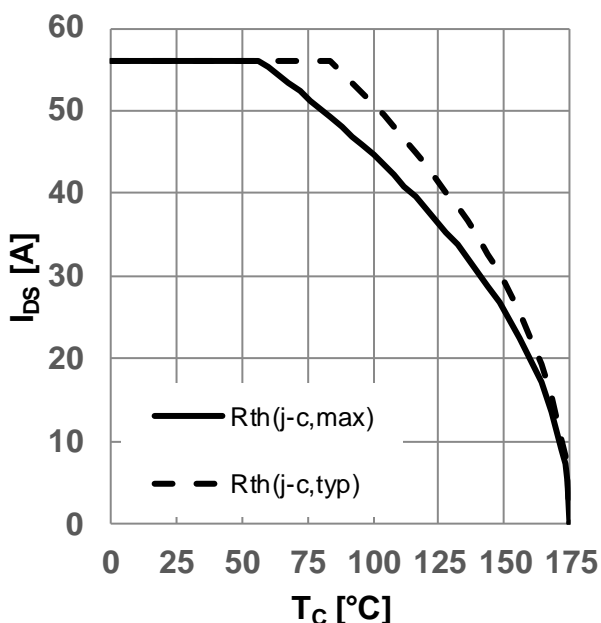
## 4 Electrical characteristic diagrams



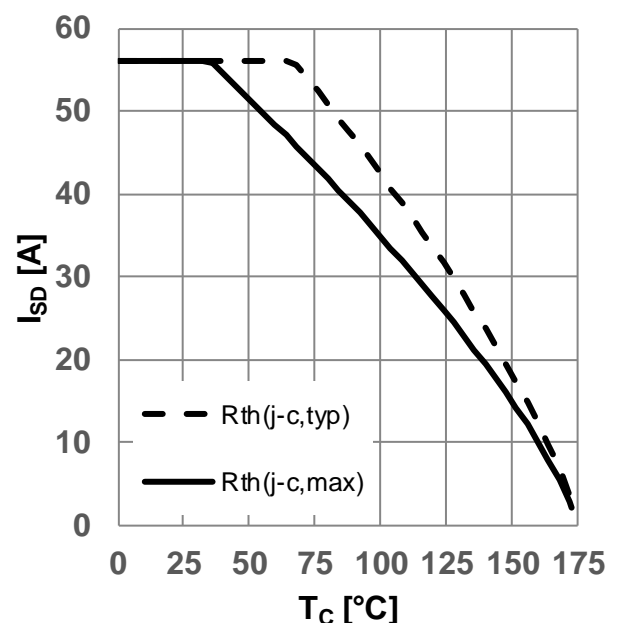
**Figure 1** Safe operating area (SOA)  
( $V_{GS} = 0/18V$ ,  $T_c = 25^\circ C$ ,  $T_j \leq 175^\circ C$ )



**Figure 2** Power dissipation as a function of case temperature limited by bond wire  
( $P_{tot} = f(T_c)$ )



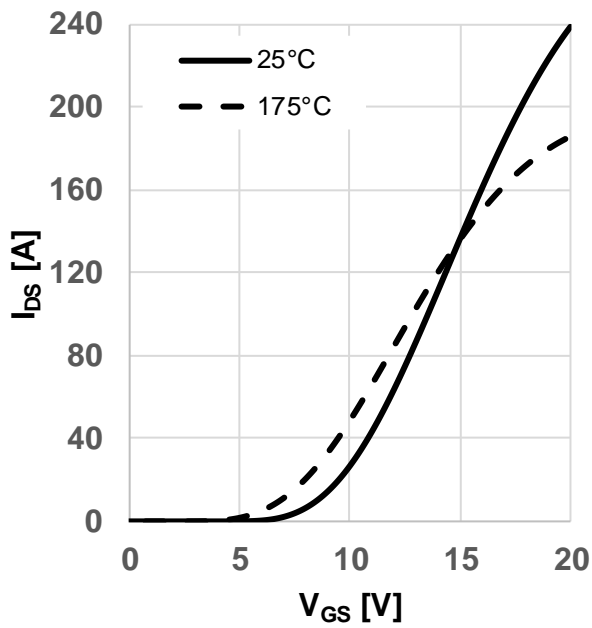
**Figure 3** Maximum DC drain to source current as a function of case temperature limited by bond wire ( $I_{DS} = f(T_c)$ )



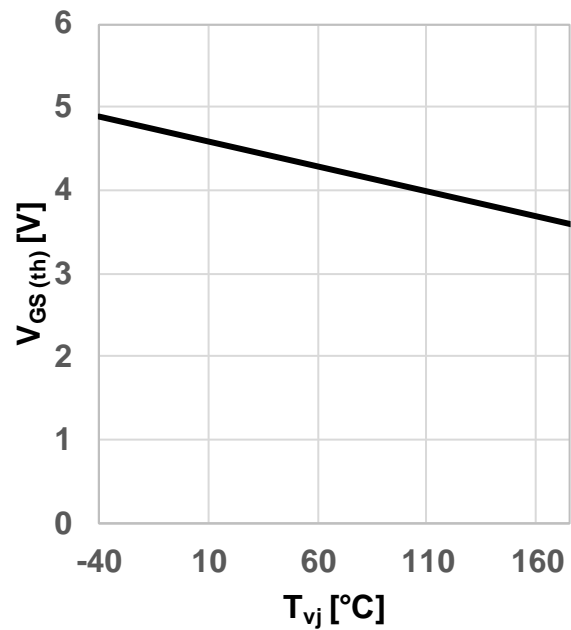
**Figure 4** Maximum source to drain current as a function of case temperature limited by bond wire ( $I_{SD} = f(T_c)$ ,  $V_{GS} = 0V$ )



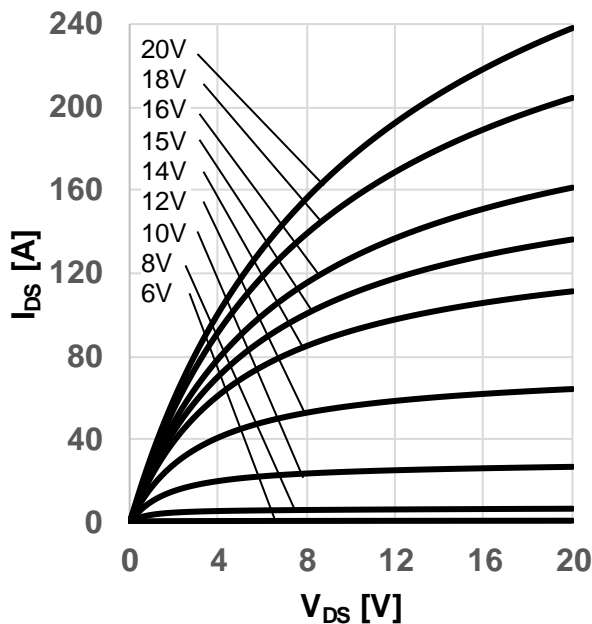
Electrical characteristic diagrams



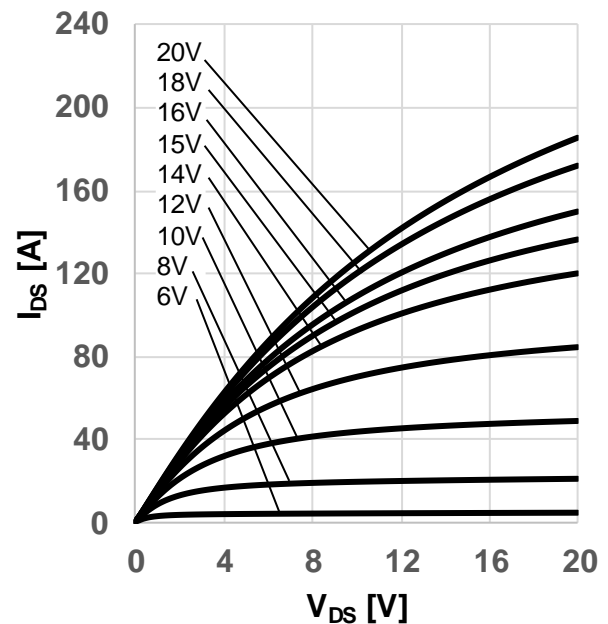
**Figure 5** Typical transfer characteristic  
( $I_{DS} = f(V_{GS})$ ,  $V_{DS} = 20V$ ,  $t_P = 20\mu s$ )



**Figure 6** Typical gate-source threshold voltage as a function of junction temperature  
( $V_{GS(th)} = f(T_{vj})$ ,  $I_{DS} = 10mA$ ,  $V_{GS} = V_{DS}$ )

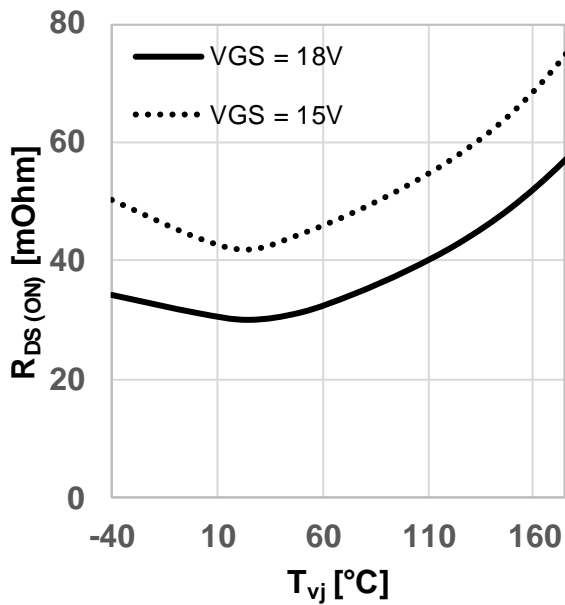


**Figure 7** Typical output characteristic,  $V_{GS}$  as parameter  
( $I_{DS} = f(V_{DS})$ ,  $T_{vj} = 25^\circ C$ ,  $t_P = 20\mu s$ )

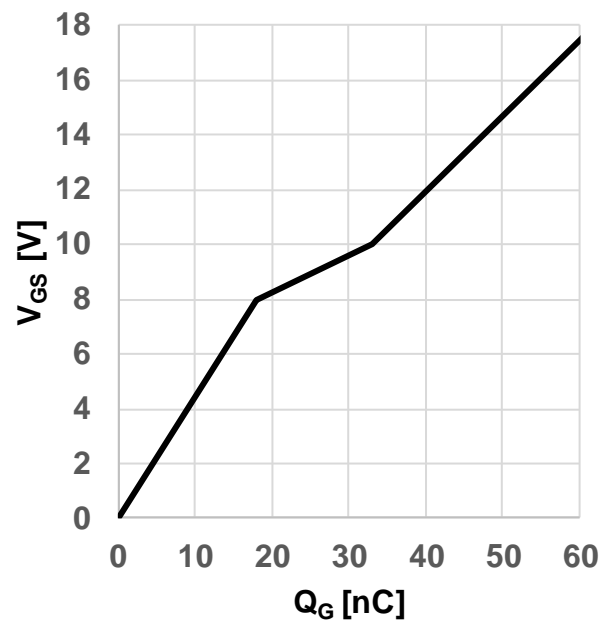


**Figure 8** Typical output characteristic,  $V_{GS}$  as parameter  
( $I_{DS} = f(V_{DS})$ ,  $T_{vj} = 175^\circ C$ ,  $t_P = 20\mu s$ )

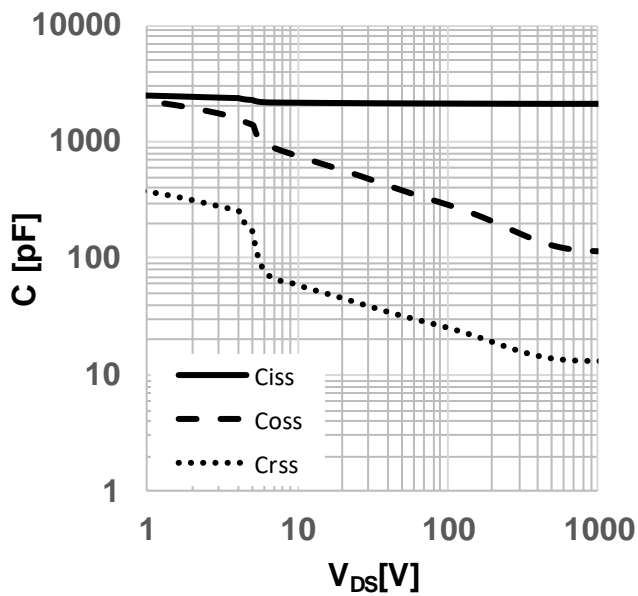
Electrical characteristic diagrams



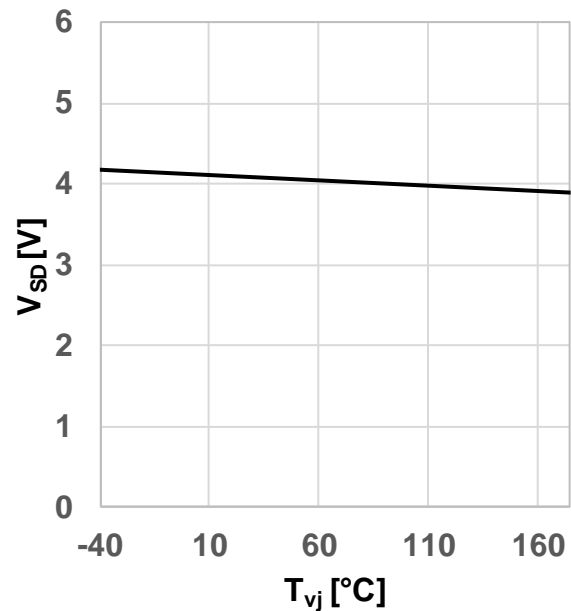
**Figure 9** Typical on-resistance as a function of junction temperature  
( $R_{DS(on)} = f(T_{vj})$ ,  $I_{DS} = 25A$ )



**Figure 10** Typical gate charge  
( $V_{GS} = f(Q_G)$ ,  $I_{DS} = 25A$ ,  $V_{DS} = 800V$ , turn-on pulse)

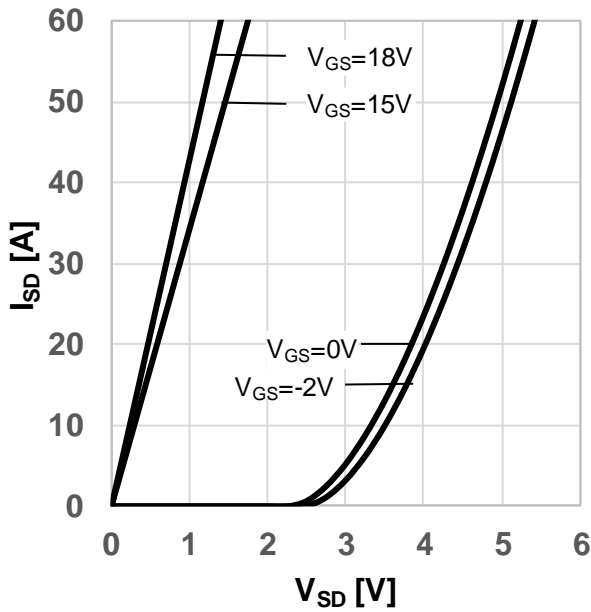


**Figure 11** Typical capacitance as a function of drain-source voltage  
( $C = f(V_{DS})$ ,  $V_{GS} = 0V$ ,  $f = 1MHz$ )

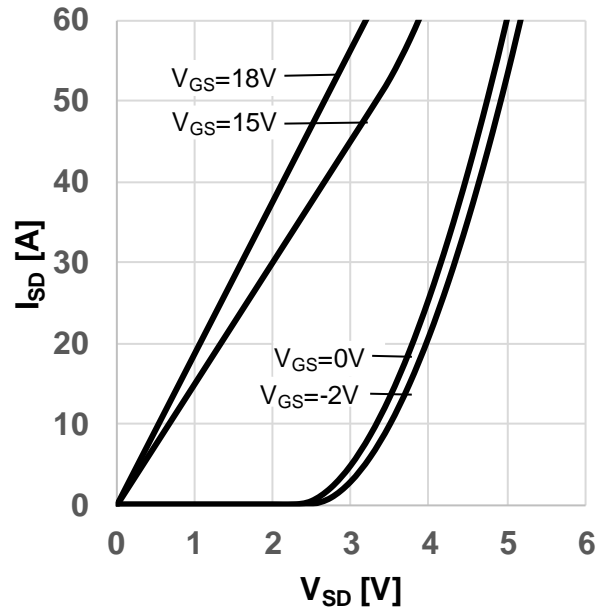


**Figure 12** Typical body diode forward voltage as function of junction temperature  
( $V_{SD} = f(T_{vj})$ ,  $V_{GS} = 0V$ ,  $I_{SD} = 25A$ )

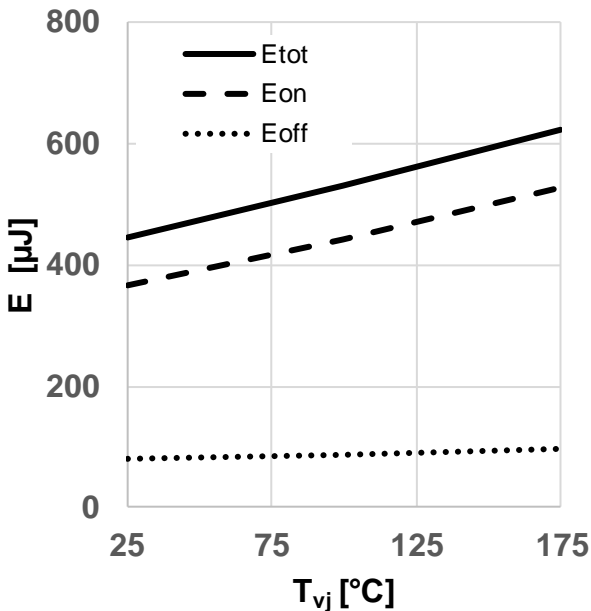
Electrical characteristic diagrams



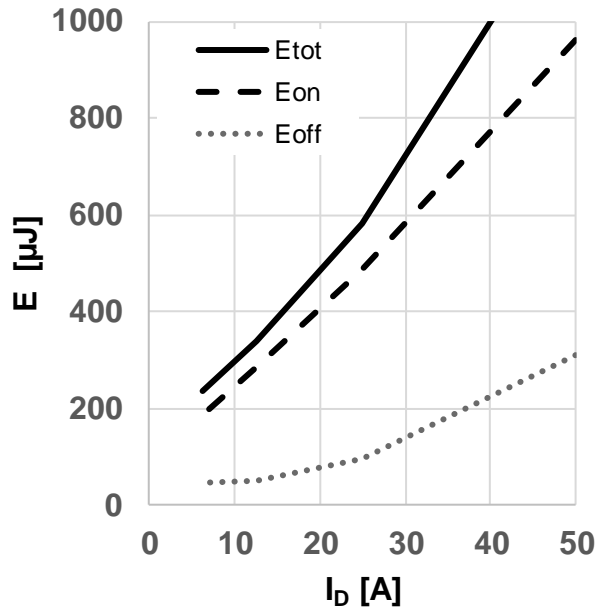
**Figure 13** Typical body diode forward current as function of forward voltage,  $V_{GS}$  as parameter  
( $I_{SD} = f(V_{SD})$ ,  $T_{vj} = 25^{\circ}\text{C}$ ,  $t_P = 20\mu\text{s}$ )



**Figure 14** Typical body diode forward current as function of forward voltage,  $V_{GS}$  as parameter  
( $I_{SD} = f(V_{SD})$ ,  $T_{vj} = 175^{\circ}\text{C}$ ,  $t_P = 20\mu\text{s}$ )

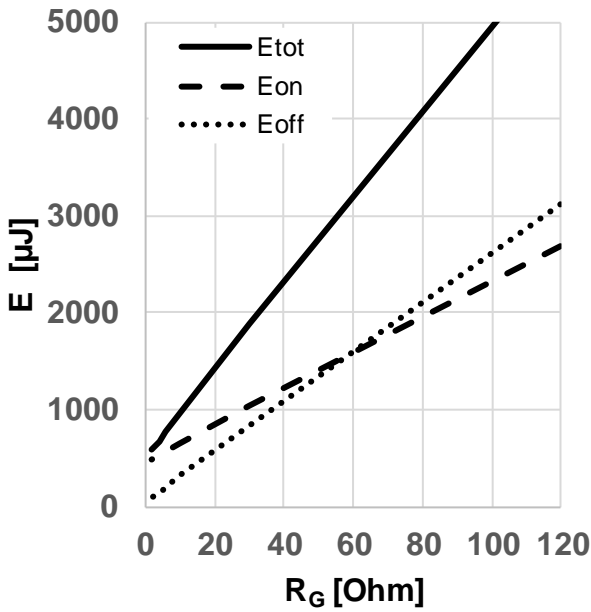


**Figure 15** Typical switching energy losses as a function of junction temperature  
( $E = f(T_{vj})$ ,  $V_{DD} = 800\text{V}$ ,  $V_{GS} = 0\text{V}/18\text{V}$ ,  $R_{G,ext} = 2\Omega$ ,  $I_D = 25\text{A}$ , ind. load, test circuit in Fig. E, diode: body diode at  $V_{GS} = 0\text{V}$ )

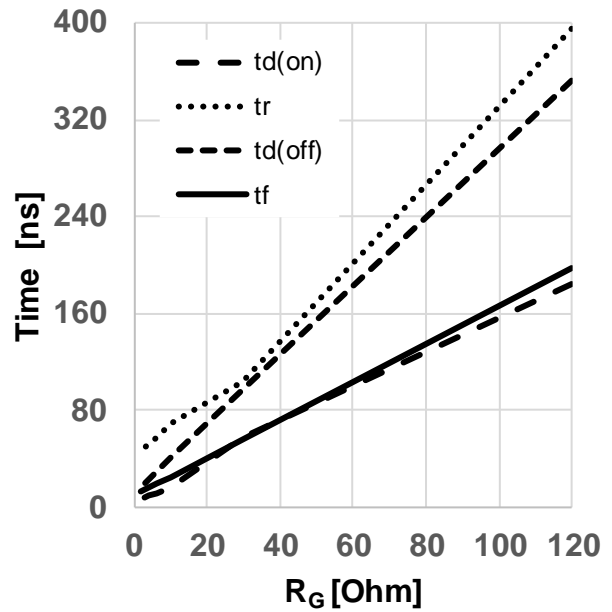


**Figure 16** Typical switching energy losses as a function of drain-source current  
( $E = f(I_{DS})$ ,  $V_{DD} = 800\text{V}$ ,  $V_{GS} = 0\text{V}/18\text{V}$ ,  $R_{G,ext} = 2\Omega$ ,  $T_{vj} = 175^{\circ}\text{C}$ , ind. load, test circuit in Fig. E, diode: body diode at  $V_{GS} = 0\text{V}$ )

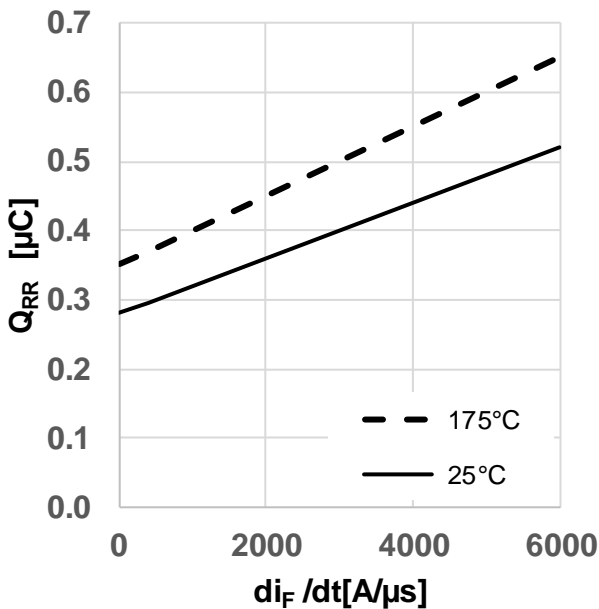
Electrical characteristic diagrams



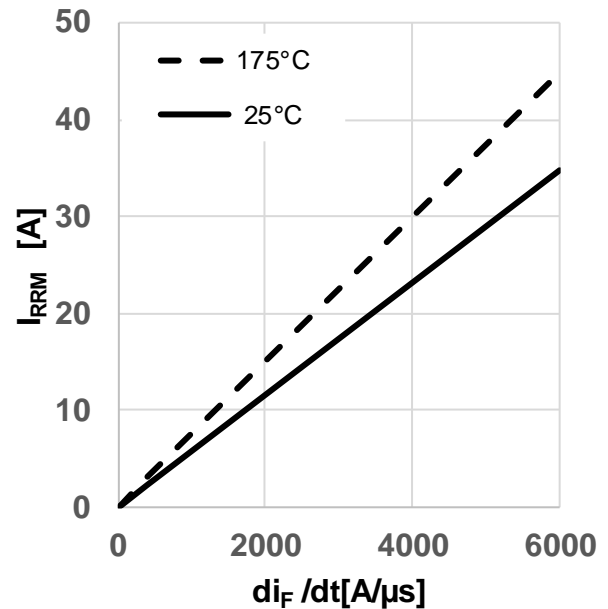
**Figure 17 Typical switching energy losses as a function of gate resistance**  
 ( $E = f(R_{G,ext})$ ,  $V_{DD} = 800V$ ,  $V_{GS} = 0V/18V$ ,  $I_D = 25A$ ,  $T_{vj} = 175^{\circ}C$ , ind. load, test circuit in Fig. E, diode: body diode at  $V_{GS} = 0V$ )



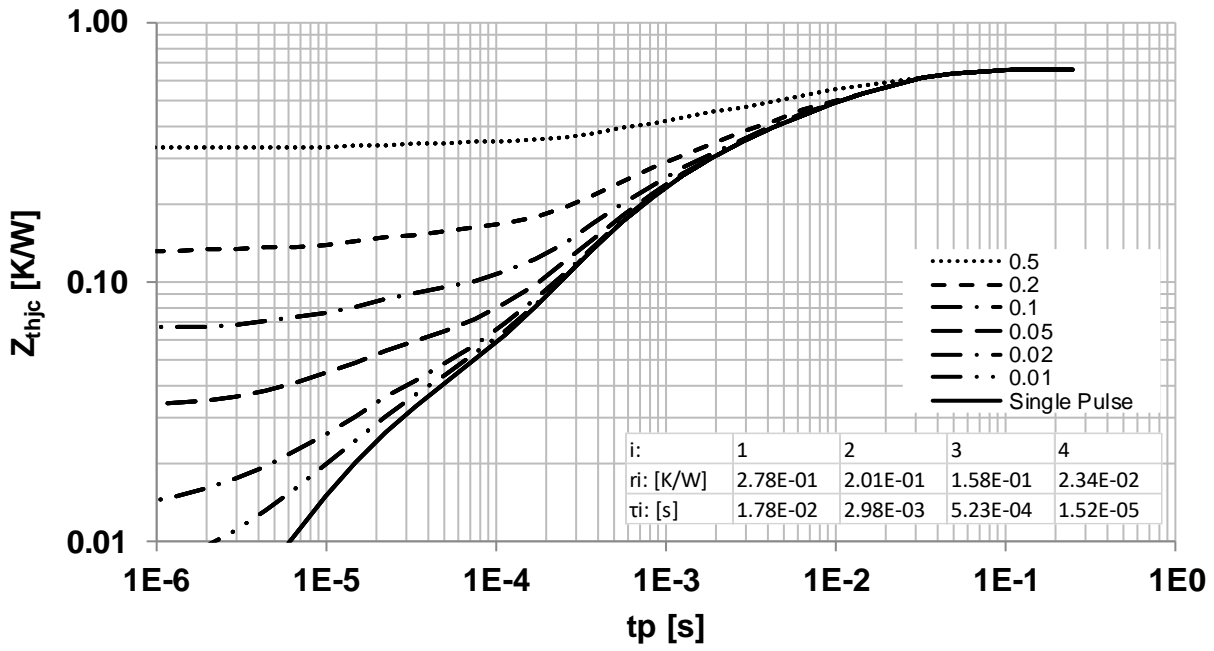
**Figure 18 Typical switching times as a function of gate resistor**  
 ( $t = f(R_{G,ext})$ ,  $V_{DD} = 800V$ ,  $V_{GS} = 0V/18V$ ,  $I_D = 25A$ ,  $T_{vj} = 175^{\circ}C$ , ind. load, test circuit in Fig. E, diode: body diode at  $V_{GS} = 0V$ )



**Figure 19 Typical reverse recovery charge as a function of diode current slope**  
 ( $Q_{rr} = f(di_i/dt)$ ,  $V_{DD} = 800V$ ,  $V_{GS} = 0V/18V$ ,  $I_D = 25A$ , ind. load, test circuit in Fig.E, body diode at  $V_{GS} = 0V$ )



**Figure 20 Typical reverse recovery current as a function of diode current slope**  
 ( $I_{rrm} = f(di_i/dt)$ ,  $V_{DD} = 800V$ ,  $V_{GS} = 0V/18V$ ,  $I_D = 25A$ , ind. load, test circuit in Fig.E, body diode at  $V_{GS} = 0V$ )



**Figure 21 Max. transient thermal resistance (MOSFET/diode)**  
 $(Z_{th(j-c,max)}) = f(t_p)$ , parameter  $D = t_p/T$ , thermal equivalent circuit in Fig. D)

Package drawing

5 Package drawing

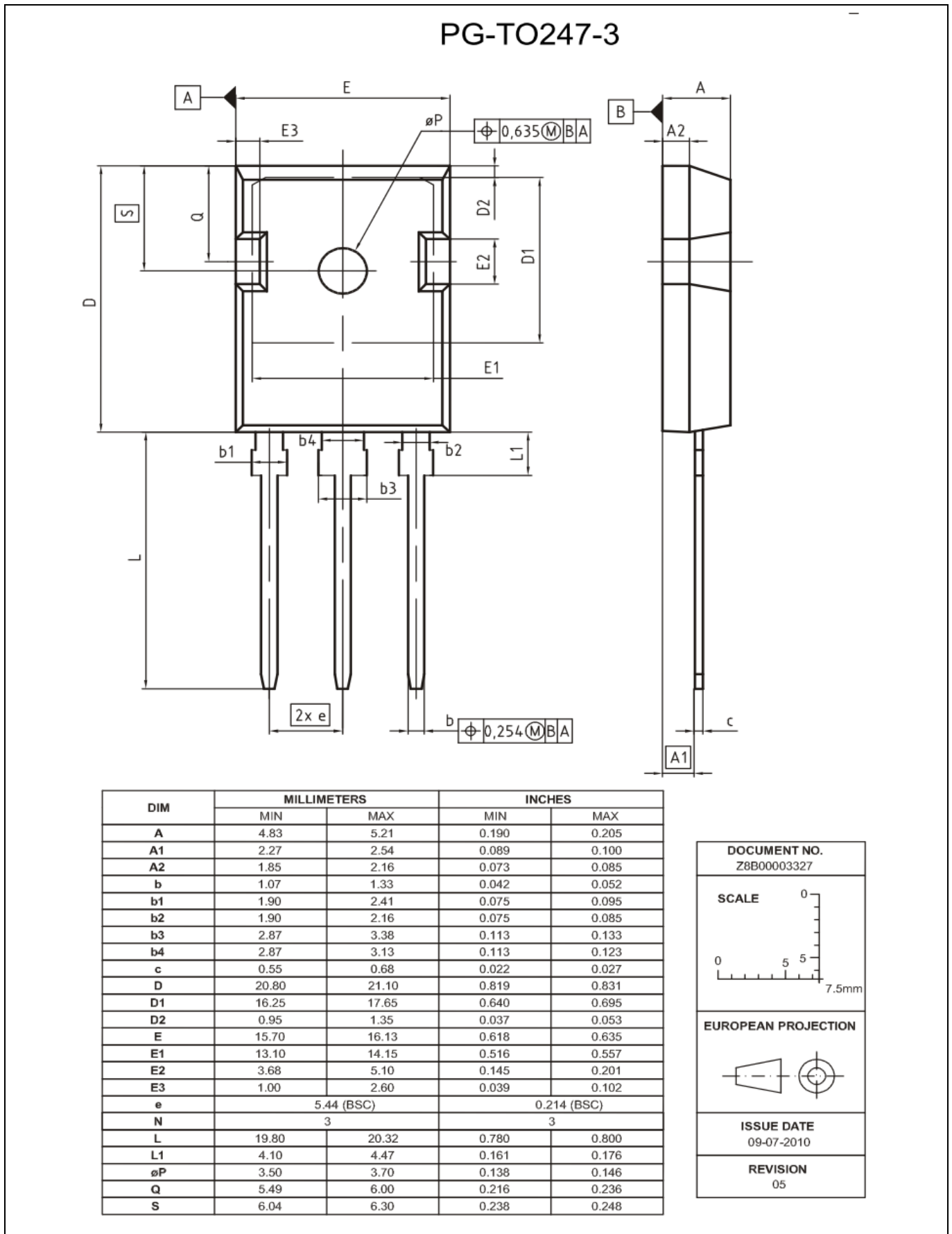


Figure 22 Package drawing

Test conditions

## 6 Test conditions

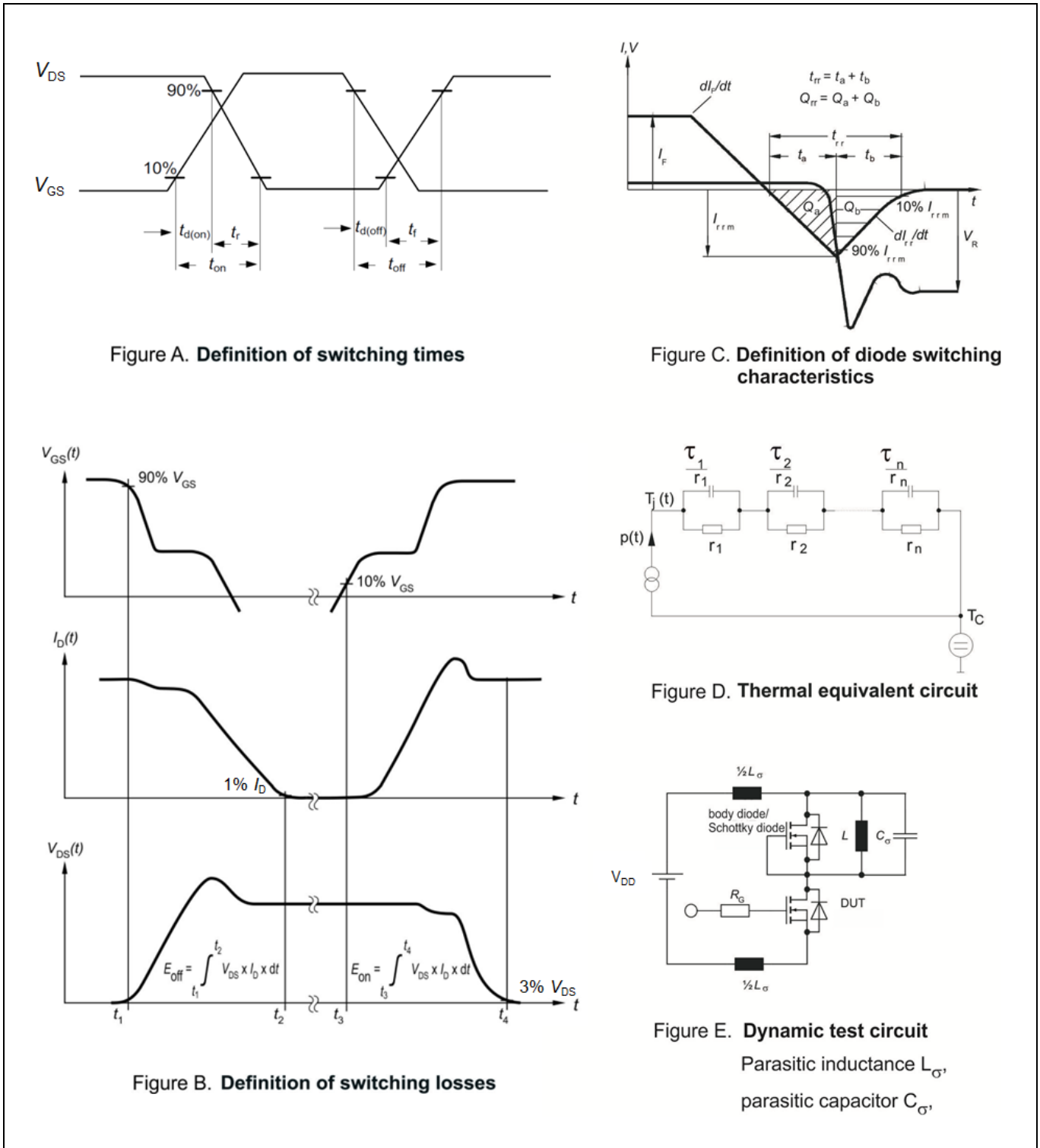


Figure 23 Test conditions

**Revision history**

**Revision history**

<b>Document version</b>	<b>Date of release</b>	<b>Description of changes</b>
2.0	2019-08-22	Final Datasheet
2.1	2019-12-10	<ul style="list-style-type: none"><li>• Move the short circuit time from dynamic characteristics table 5 to maximum ratings table 2.</li><li>• Update the Figure 12, 13, 14 the body diode forward voltage.</li></ul>



## **Trademarks**

All referenced product or service names and trademarks are the property of their respective owners.

## **Published by**

**Infineon Technologies AG**

**81726 München, Germany**

**© Infineon Technologies AG 2019.**

**All Rights Reserved.**

## **Important notice**

The information given in this document shall in no event be regarded as a guarantee of conditions or characteristics (“Beschaffheitsgarantie”). With respect to any examples, hints or any typical values stated herein and/or any information regarding the application of the product, Infineon Technologies hereby disclaims any and all warranties and liabilities of any kind, including without limitation warranties of non-infringement of intellectual property rights of any third party.

In addition, any information given in this document is subject to customer’s compliance with its obligations stated in this document and any applicable legal requirements, norms and standards concerning customer’s products and any use of the product of Infineon Technologies in customer’s applications.

The data contained in this document is exclusively intended for technically trained staff. It is the responsibility of customer’s technical departments to evaluate the suitability of the product for the intended application and the completeness of the product information given in this document with respect to such application.

For further information on the product, technology, delivery terms and conditions and prices please contact your nearest Infineon Technologies office ([www.infineon.com](http://www.infineon.com)).

Please note that this product is not qualified according to the AEC Q100 or AEC Q101 documents of the Automotive Electronics Council.

## **Warnings**

Due to technical requirements products may contain dangerous substances. For information on the types in question please contact your nearest Infineon Technologies office.

Except as otherwise explicitly approved by Infineon Technologies in a written document signed by authorized representatives of Infineon Technologies, Infineon Technologies’ products may not be used in any applications where a failure of the product or any consequences of the use thereof can reasonably be expected to result in personal injury.