

### Features

- Batch process design, excellent power dissipation offers better reverse leakage current and thermal resistance
- Low profile surface mounted application in order to optimize board space
- Low power loss, high efficiency
- High current capability, low forward voltage drop
- High surge capability
- Guardring for overvoltage protection
- Ultra high-speed switching
- Silicon epitaxial planar chip, metal silicon junction
- Lead-free parts meet RoHS requirements
- Suffix "-H" indicates Halogen free parts, ex. AS320-AL-H

### Mechanical data

- Epoxy: UL94-V0 rated flame retardant
- Case : Molded plastic, DO-214AC / SMA-L
- Terminals : Solder plated, solderable per MIL-STD-750, Method 2026
- Polarity : Indicated by cathode band
- Mounting Position : Any
- Weight : Approximated 0.05 gram

### Package outline

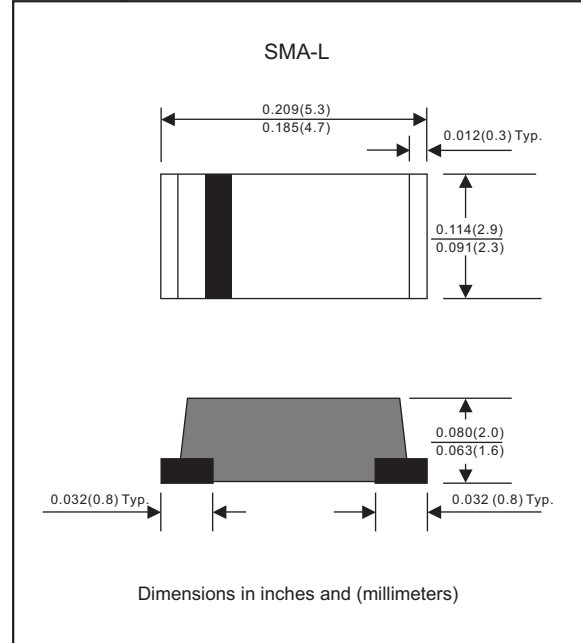

### Maximum ratings (AT $T_A=25^{\circ}\text{C}$ unless otherwise noted)

PARAMETER	SYMBOLS	AS 320-AL	AS 330-AL	AS 340-AL	AS 350-AL	AS 360-AL	AS 380-AL	AS 3100-AL	AS 3150-AL	AS 3200-AL	UNIT	
Maximum repetitive peak reverse voltage	$V_{RRM}$	20	30	40	50	60	80	100	150	200	V	
Maximum RMS voltage	$V_{RMS}$	14	21	28	35	42	56	70	105	140	V	
Maximum continuous reverse voltage	$V_R$	20	30	40	50	60	80	100	150	200	V	
Maximum average forward rectified current	$I_O$	3.0									A	
Non-repetitive peak forward surge current 8.3ms single half sine-wave	$I_{FSM}$	80									A	
Typical junction capacitance (Note 1)	$C_J$	250									pF	
Operating junction temperature range	$T_J$	-55 to +125				-55 to +150						$^{\circ}\text{C}$
Storage temperature range	$T_{STG}$	-65 to +175										$^{\circ}\text{C}$

### Electrical characteristics (AT $T_A=25^{\circ}\text{C}$ unless otherwise noted)

PARAMETER	SYMBOLS	AS 320-AL	AS 330-AL	AS 340-AL	AS 350-AL	AS 360-AL	AS 380-AL	AS 3100-AL	AS 3150-AL	AS 3200-AL	UNIT	
Maximum instantaneous forward voltage at $I_F=3.0\text{A}$	$V_F$	0.475	0.50		0.70		0.85	0.90	0.92	V		
Maximum reverse leakage current at rated $V_R$	$I_R$						0.5					mA
							20					mA

### Thermal characteristics

PARAMETER	SYMBOLS	AS 320-AL	AS 330-AL	AS 340-AL	AS 350-AL	AS 360-AL	AS 380-AL	AS 3100-AL	AS 3150-AL	AS 3200-AL	UNIT	
Typical thermal resistance junction to ambient (Note2)	$R_{\theta JA}$						52					$^{\circ}\text{C/W}$
Typical thermal resistance junction to case (Note 2)	$R_{\theta JC}$						26					$^{\circ}\text{C/W}$

Notes1: Measured at 1MHz and applied reverse voltage of 4.0V D.C

2: Mounted on FR-4 PCB copper, minimum recommended pad layout

## Rating and characteristic curves (AS320-AL THRU AS3200-AL)

FIG.1-TYPICAL FORWARD CURRENT DERATING CURVE

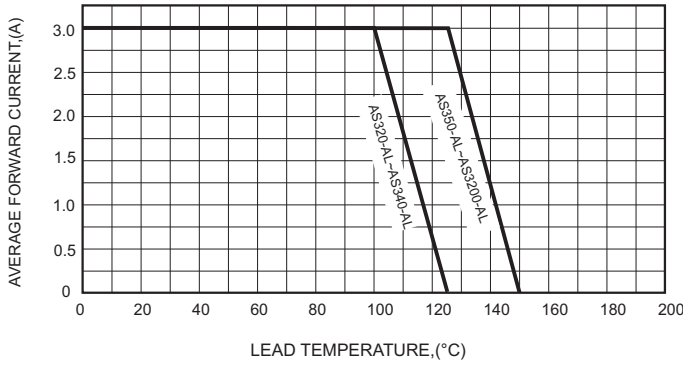

FIG.2-TYPICAL FORWARD CHARACTERISTICS

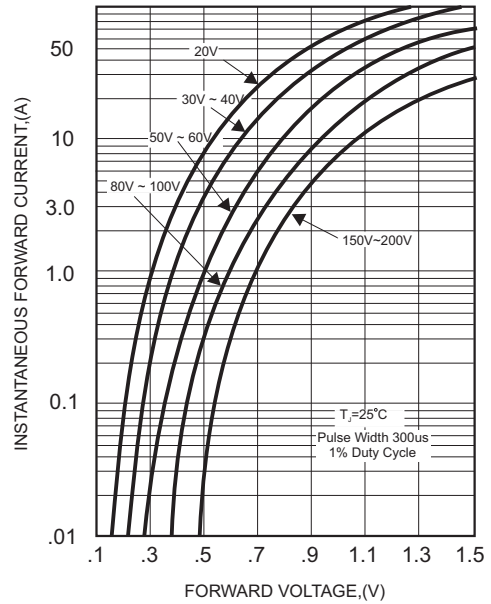

FIG.3-MAXIMUM NON-REPETITIVE FORWARD SURGE CURRENT

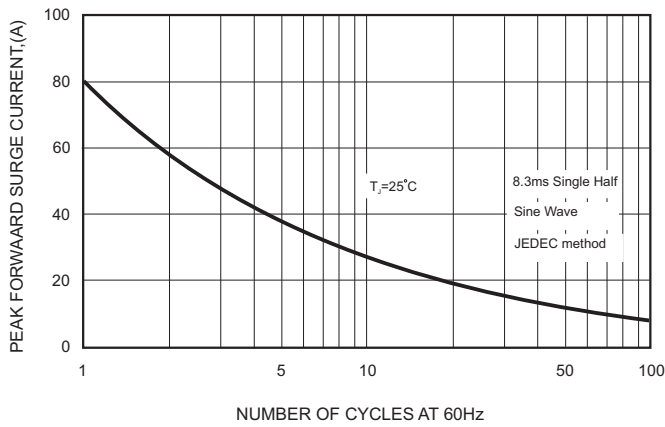

FIG.5 - TYPICAL REVERSE CHARACTERISTICS

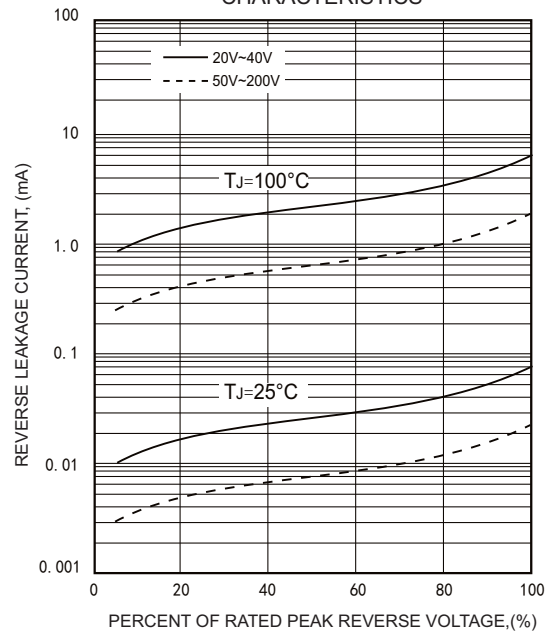
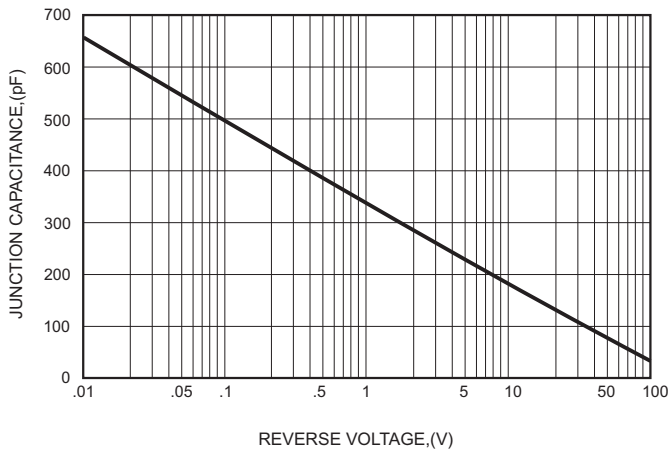



FIG.4-TYPICAL JUNCTION CAPACITANCE



### Pinning information

Pin	Simplified outline	Symbol
Pin1 cathode Pin2 anode		

### Marking

Type number	Marking code
AS320-AL	SK32
AS330-AL	SK33
AS340-AL	SK34
AS350-AL	SS35
AS360-AL	SS36
AS380-AL	SS38
AS3100-AL	S310
AS3150-AL	S315
AS3200-AL	S320

### Suggested solder pad layout

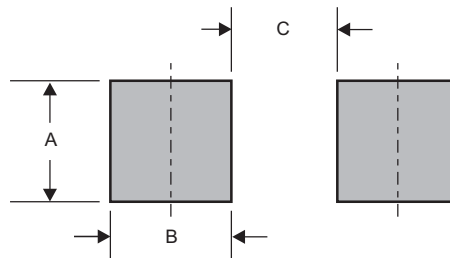

Dimensions in inches and (millimeters)

PACKAGE	A	B	C
SMA-L	0.110 (2.80)	0.059 (1.50)	0.110 (2.80)