



Photocoupler

Product Data Sheet

6N138-L / 6N139-L Series

Spec No.: DS70-2009-0001

Effective Date: 04/12/2016

Revision: A

LITE-ON DCC

RELEASE

BNS-OD-FC001/A4

Photocoupler 6N138-L 6N139-L series

1. DESCRIPTION

These high gain series couplers use a light emitter diode and an integrated high gain photo detector to provide extremely high current transfer ratio between input and output. Separate pins for the photodiode and output stage result in TTL compatible saturation voltage and high speed operation. Where desired the V_{CC} and V_O terminals may be tied together to achieve conventional photo Darlington operation. A base access terminal allows a gain bandwidth adjustment to be made.

1.1 Features

- High current transfer ratio – 2000% typical.
- Low input current requirements – 0.5mA
- High output current – 60mA
- CTR guarantee – 0~70°C.
- Instantaneous common mode rejection 10KV/ μ sec
- TTL compatible output – 0.1V V_{OL} typical
- UL, CSA approved.

1.2 Applications

- Digital logic ground isolation
- Low input current line receiver
- Telephone ring detector
- EIA-RS-232C line receiver
- Current loop receiver
- High common mode noise line receiver

1.3 Functional Diagram

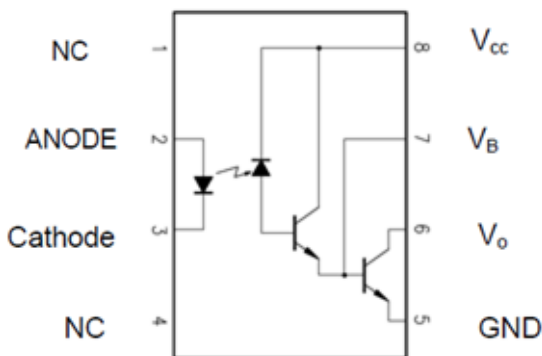

A 0.1 μ F bypass Capacitor must be connected between Pin8 and Pin5

Truth Table (Positive Logic)

LED	OUT
ON	L
OFF	H

Photocoupler 6N138-L 6N139-L series

2. PACKAGE DIMENSIONS

2.1 6N138-L

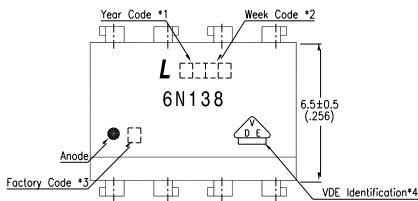

2.2 6N138M-L

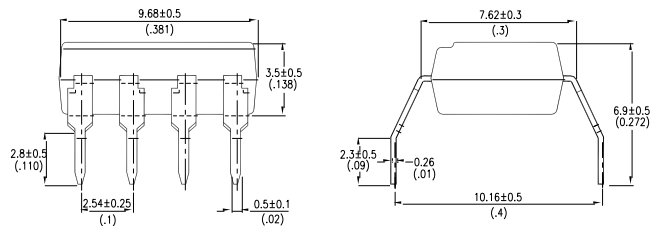
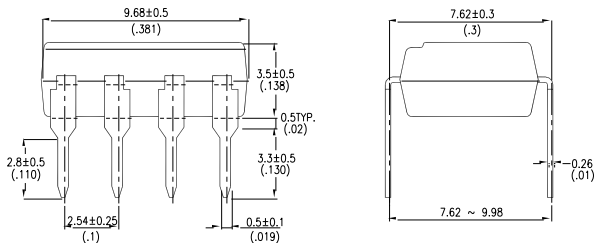
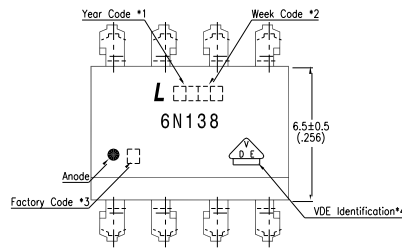

2.3 6N138S-L

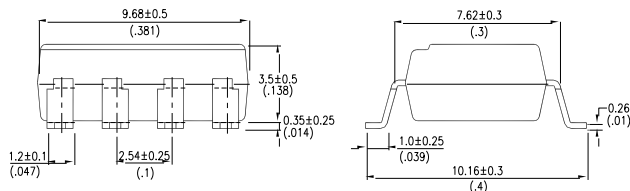
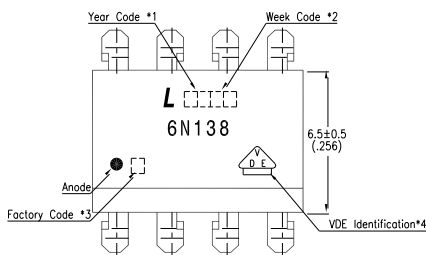

Notes :

1. Year date code.
2. 2-digit work week.
3. Factory identification mark shall be marked (Y: Thailand , W: China-CZ)
4. For VDE option.

Dimensions in millimeters (inches).

Photocoupler 6N138-L 6N139-L series

2.4 6N139-L

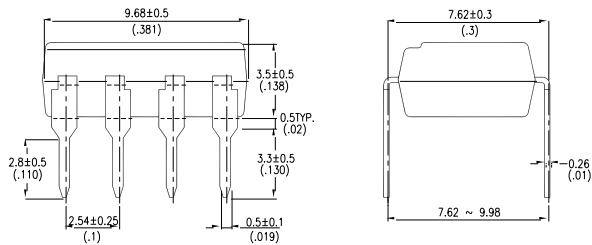
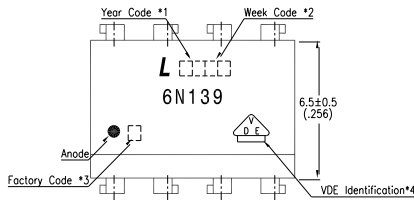

2.5 6N139M-L

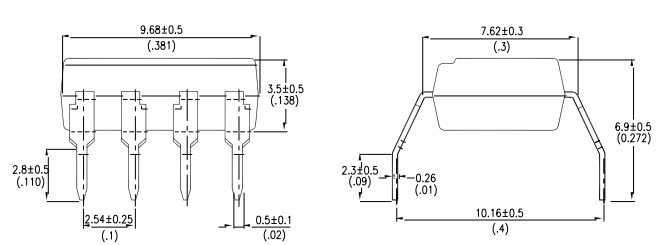
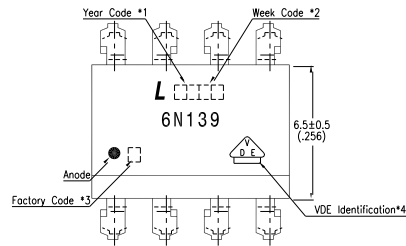

2.6 6N139S-L

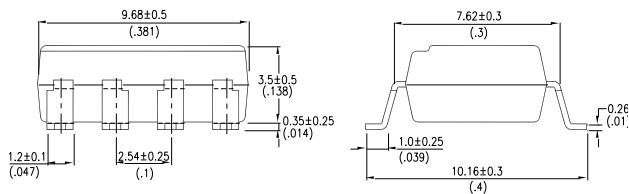
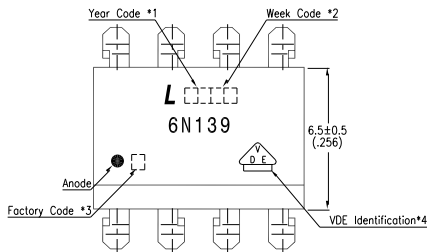

Notes :

1. Year date code.
2. 2-digit work week.
3. Factory identification mark shall be marked (Y: Thailand , W: China-CZ)
4. For VDE option.

Dimensions in millimeters (inches).

Photocoupler 6N138-L 6N139-L series

3. TAPING DIMENSIONS

3.1 6N138S-TA-L/ 6N139S-TA-L

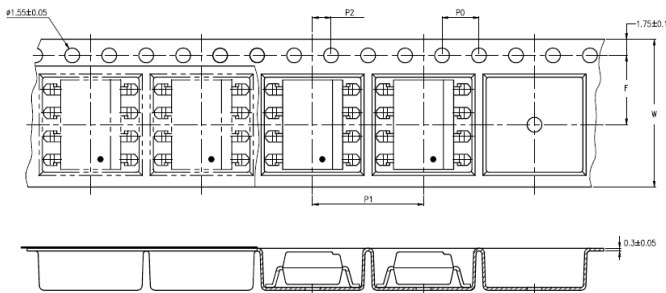

3.2 6N138S-TA1-L/ 6N139S-TA1-L

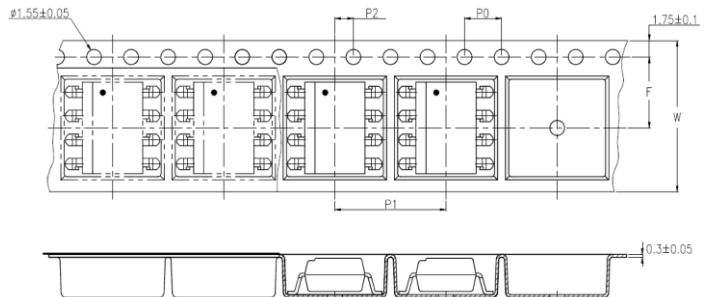

Description	Symbol	Dimension in mm (inch)
Tape wide	W	16±0.3 (0.63)
Pitch of sprocket holes	P ₀	4±0.1 (0.15)
Distance of compartment	F	7.5±0.1 (0.295)
	P ₂	2±0.1 (0.079)
Distance of compartment to compartment	P ₁	12±0.1 (0.472)

3.3 Quantities Per Reel

Package Type	TA / TA1
Quantities (pcs)	1000

Photocoupler 6N138-L 6N139-L series

4. RATING AND CHARACTERISTICS

4.1 Absolute Maximum Ratings at Ta=25°C *1

	Parameter		Symbol	Rating	Unit	Note
Input	Average Forward Input Current		I_F	20	mA	2
	Reverse Input Voltage		V_R	5	V	
	Power Dissipation		P_i	35	mW	
Output	Output Collector Current		I_O	50	mA	
	Output Voltage	6N138	V_O	7	V	
		6N139		18		
Output Collector Power Dissipation		P_o	100	mW		
Isolation Voltage			V_{iso}	5000	V_{rms}	
	Supply Voltage	6N138	V_{CC}	7	V	
		6N139		18		
Operating Temperature			T_{opr}	-40 ~ +85	°C	
Storage Temperature			T_{stg}	-55 ~ +125	°C	
Lead Solder Temperature *2			T_{sol}	260	°C	

1. Ambient temperature = 25°C, unless otherwise specified. Stresses exceeding the absolute maximum ratings can cause permanent damage to the device. Exposure to absolute maximum ratings for long periods of time can adversely affect reliability.
2. 260°C for 10 seconds. Refer to Lead Free Reflow Profile.

Photocoupler 6N138-L 6N139-L series

4.2 ELECTRICAL CHARACTERISTICS at Ta = 25°C

Parameters	Test Condition	Symbol	Device	Min	Typ	Max	Units	
Input								
Input Forward Voltage	$I_F=1.6\text{mA}$, $T_A=25^\circ\text{C}$	V_F	6N138 6N139		1.1	1.7	V	
Input Forward Voltage Temperature Coefficient	$I_F=1.6\text{mA}$	$\Delta V_F/\Delta T_A$				-1.9		mV/°C
Input Reverse Voltage	$I_R = 10\mu\text{A}$ $T_A=25^\circ\text{C}$	BV_R			5	-	-	V
Input Capacitance	$V_F=0$; $f=1\text{MHz}$	C_{IN}			-	60	-	pF
Detector								
Current transfer ratio	$I_F=1.6\text{mA}$; $V_o=0.4\text{V}$; $V_{cc}=4.5\text{V}$	CTR	6N138	300	1600	2600	%	
	$I_F=0.5\text{mA}$; $V_o=0.4\text{V}$; $V_{cc}=4.5\text{V}$		6N139	400	2000	5000		
	$I_F=1.6\text{mA}$; $V_{cc}=0.4\text{V}$; $V_{cc}=4.5\text{V}$			500	1600	2600		
Logic low output voltage	$I_F=1.6\text{mA}$; $V_{cc}=4.5\text{V}$; $I_o=4.8\text{mA}$	V_{OL}	6N138	-	0.1	0.4	V	
	$I_F=0.5\text{mA}$; $V_{cc}=4.5\text{V}$; $I_o=2\text{mA}$		6N139	-	0.1	0.4		
	$I_F=1.6\text{mA}$; $V_{cc}=4.5\text{V}$; $I_o=8\text{mA}$			-	0.1	0.4		
	$I_F=5\text{mA}$; $V_{cc}=4.5\text{V}$; $I_o=15\text{mA}$			-	0.1	0.4		
	$I_F=12\text{mA}$; $V_{cc}=4.5\text{V}$; $I_o=24\text{mA}$			-	0.2	0.4		
Logic high output current	$I_F=0\text{mA}$, $V_o=V_{cc}=7\text{V}$; $T_A=25^\circ\text{C}$	I_{OH}	6N138	-	0.05	250	μA	
	$I_F=0\text{mA}$, $V_o=V_{cc}=18\text{V}$; $T_A=25^\circ\text{C}$		6N139	-	0.1	100		
Logic low supply current	$I_F=1.6\text{mA}$, $V_o=\text{open}$ ($V_{cc}=18\text{V}$)	I_{ccl}	6N138 6N139	-	0.4	1.5	mA	
Logic high supply current	$I_F=0\text{mA}$, $V_o=\text{open}$; $T_A=25^\circ\text{C}$ ($V_{cc}=18\text{V}$)	I_{cch}	6N138	-	0.01	10	mA	
			6N139	-	0.01	10		

Specified over recommended temperature ($T_A = -40^\circ\text{C}$ to $+85^\circ\text{C}$, $4.5\text{V} \leq V_{CC} \leq 5.5\text{V}$), $I_F = 7.5\text{mA}$ unless otherwise specified. All typicals at $T_A = 25^\circ\text{C}$, $V_{CC} = 5.0\text{V}$.

Photocoupler 6N138-L 6N139-L series

5. SWITCHING SPECIFICATIONS (AC)

Parameter	Test Condition	Symbol	Device	Min	Typ	Max	Units
Propagation Delay Time to Low Output Level	$I_F=1.6\text{mA}; R_L=2.2\text{k}\Omega$	t_{PHL}	6N138	-	1.6	10	μs
	$I_F=0.5\text{mA}; R_L=4.7\text{k}\Omega$		6N139	-	5	25	
	$I_F=12\text{mA}; R_L=270\Omega$			-	0.1	1	
Propagation Delay Time to High Output Level	$I_F=1.6\text{mA}; R_L=2.2\text{k}\Omega$	t_{PLH}	6N138	-	10	35	μs
	$I_F=0.5\text{mA}; R_L=4.7\text{k}\Omega$		6N139	-	18	60	
	$I_F=12\text{mA}; R_L=270\Omega$			-	2	7	
Logic High Common Mode Transient Immunity	$I_F=0\text{mA}; V_{CM} =10V_{p-p}$ $R_L=2.2\text{k}\Omega$	$ CM_H $	6N138	1	10	-	$\text{KV}/\mu\text{s}$
			6N139				$\text{KV}/\mu\text{s}$
Logic Low Common Mode Transient Immunity	$I_F=1.6\text{mA}; V_{CM} =10V_{p-p}$ $R_L=2.2\text{k}\Omega$	$ CM_L $	6N138	1	10	-	$\text{KV}/\mu\text{s}$
			6N139				$\text{KV}/\mu\text{s}$

*All Typical at $T_A=25^\circ\text{C}$

Photocoupler 6N138-L 6N139-L series

6. ISOLATION CHARACTERISTIC

Parameter	Symbol	Min.	Typ.	Max.	Unit	Test Condition
Input-Output Insulation Leakage Current	I_{I-O}	—	—	1.0	μA	45% RH, $t = 5s$, $V_{I-O} = 3kV DC$, $T_A = 25^\circ C$
Withstand Insulation Test Voltage	V_{ISO}	5000	—	—	V_{RMS}	RH $\leq 50\%$, $t = 1min$, $T_A = 25^\circ C$
Input-Output Resistance	R_{I-O}	—	10^{12}	—	Ω	$V_{I-O} = 500V DC$

*All Typical at $T_A = 25^\circ C$

Notes

1. AC For 1 Minute, R.H. = 40 ~ 60%. Isolation voltage shall be measured using the following method.

(1) Short between anode and cathode on the primary side and between collector and emitter on the secondary side.

(2) The isolation voltage tester with zero-cross circuit shall be used.

(3) The waveform of applied voltage shall be a sine wave.

2. For 10 Seconds

3. Current Transfer Ratio (CTR) is defined as the ration of output collector current, I_o , to the forward LED input current, I_F , times 100%.

4. Pin 7 open.

5. Instantaneous common mode rejection voltage "output (1)" represents a common mode voltage variation that can hold the output above (1) level ($V_o > 2.0V$). Instantaneous common mode rejection voltage "output (0)" represents a common mode voltage variation that can hold the output above (0) level ($V_o < 0.8V$).

6. Device considered a two terminal device. Pins 1, 2, 3 and 4 shorted together and Pins 5, 6, 7 and 8 shorted together.

Photocoupler 6N138-L 6N139-L series

7. SWITCHING TIME TEST CIRCUIT

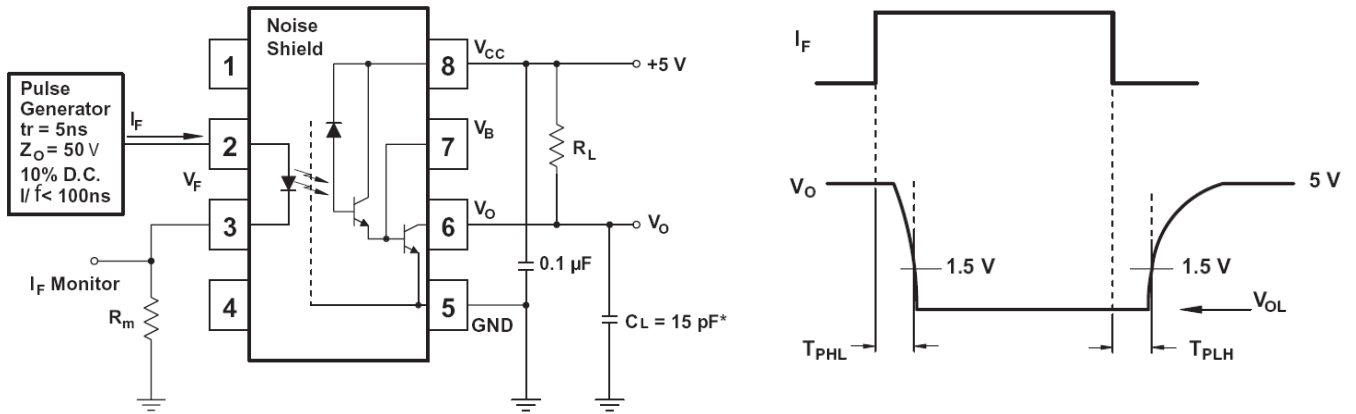

Figure 1: Single Channel Test Circuit for t_{PHL} and t_{PLH}

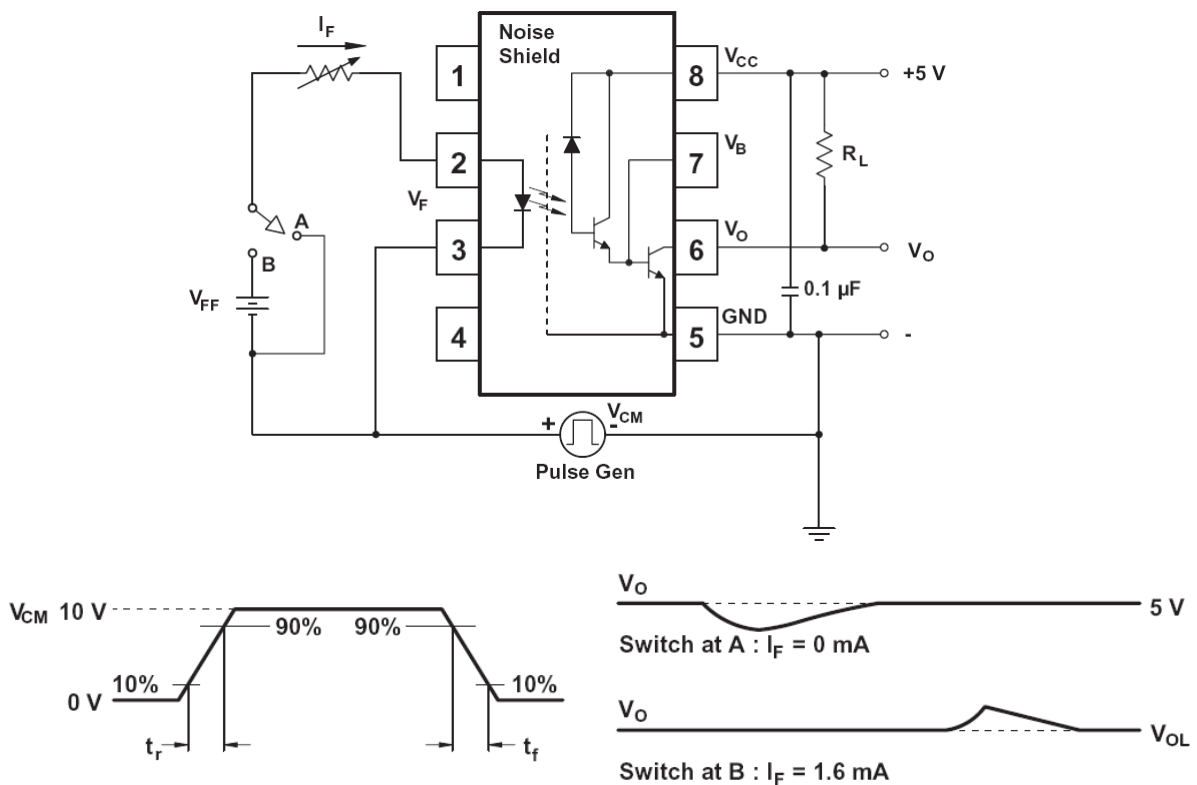

Figure 2: Single Channel Test Circuit for Common Mode Transient Immunity

Photocoupler 6N138-L 6N139-L series

8. CHARACTERISTIC CURVES

Figure 3: DC transfer characteristics

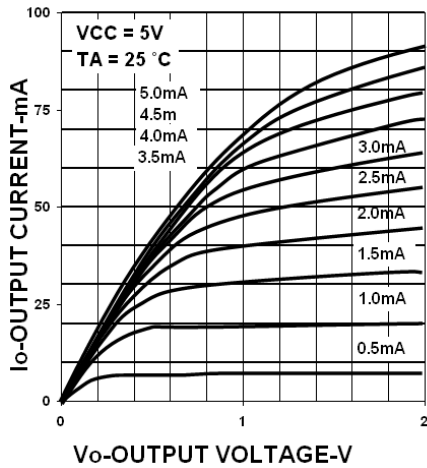

Figure 4: output current vs. input diode forward

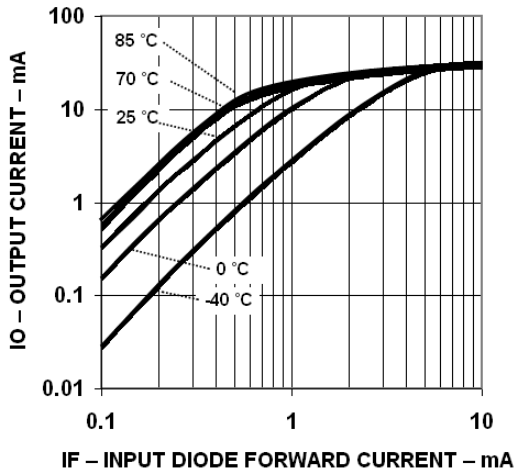

Figure 5: 6N139 propagation delay vs. temperature

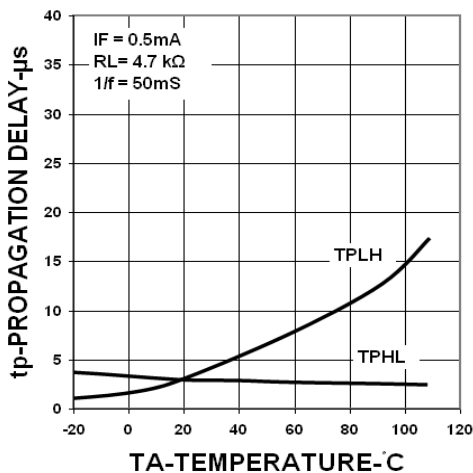

Figure 6: current transfer ratio vs. forward current

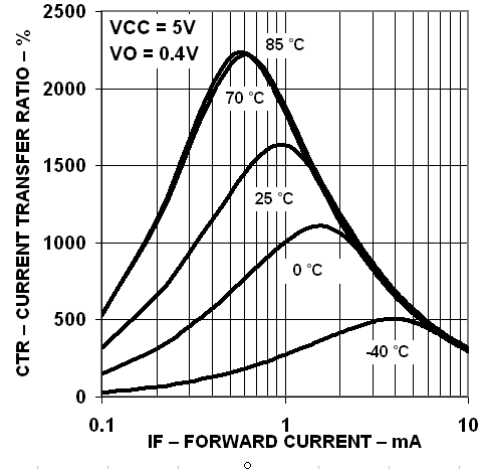

Figure 7: current transfer ratio vs. forward current

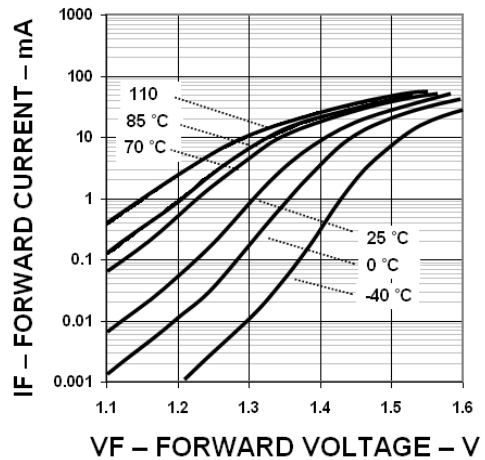
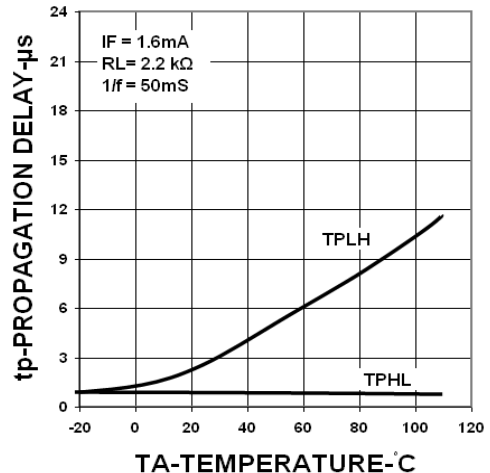

Figure 8: 6N138 propagation delay vs. temperature



Photocoupler 6N138-L 6N139-L series

Figure 9: 6N139 propagation delay vs. temperature

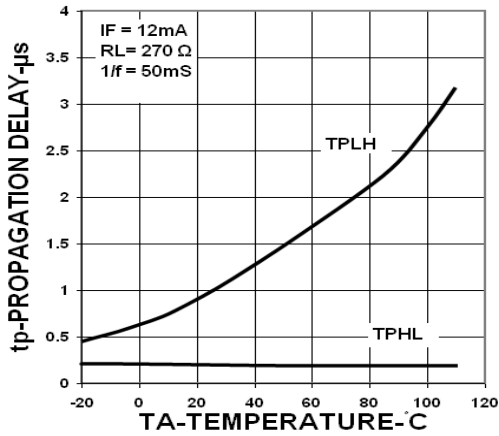

Figure 11: Forward voltage vs. temperature

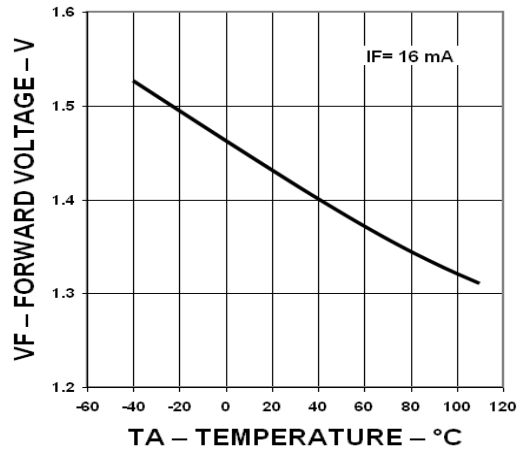

Figure 10: Nonsaturated rise and fall time vs. load resistance

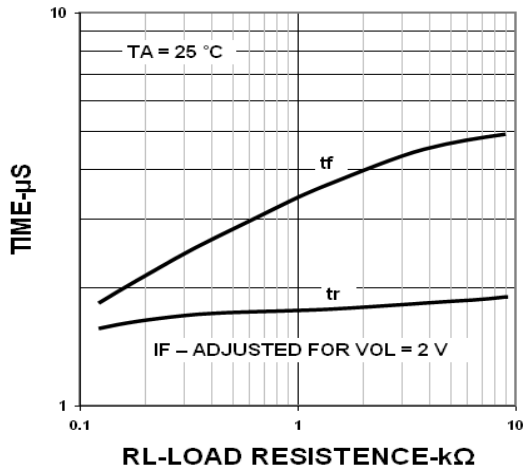
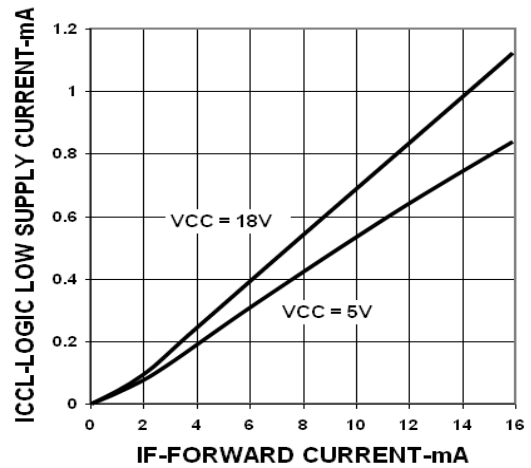

Figure 12: Logic low supply current vs. forward current



Photocoupler 6N138-L 6N139-L series

9. TEMPERATURE PROFILE OF SOLDERING

9.1 IR Reflow soldering (JEDEC-STD-020C compliant)

One time soldering reflow is recommended within the condition of temperature and time profile shown below. Do not solder more than three times.

Profile item	Conditions
Preheat	
- Temperature Min (T_{Smin})	150°C
- Temperature Max (T_{Smax})	200°C
- Time (min to max) (ts)	90±30 sec
Soldering zone	
- Temperature (T_L)	217°C
- Time (t_L)	60 ~ 100 sec
Peak Temperature (T_P)	260°C
Ramp-up rate	3°C / sec max.
Ramp-down rate	3~6°C / sec

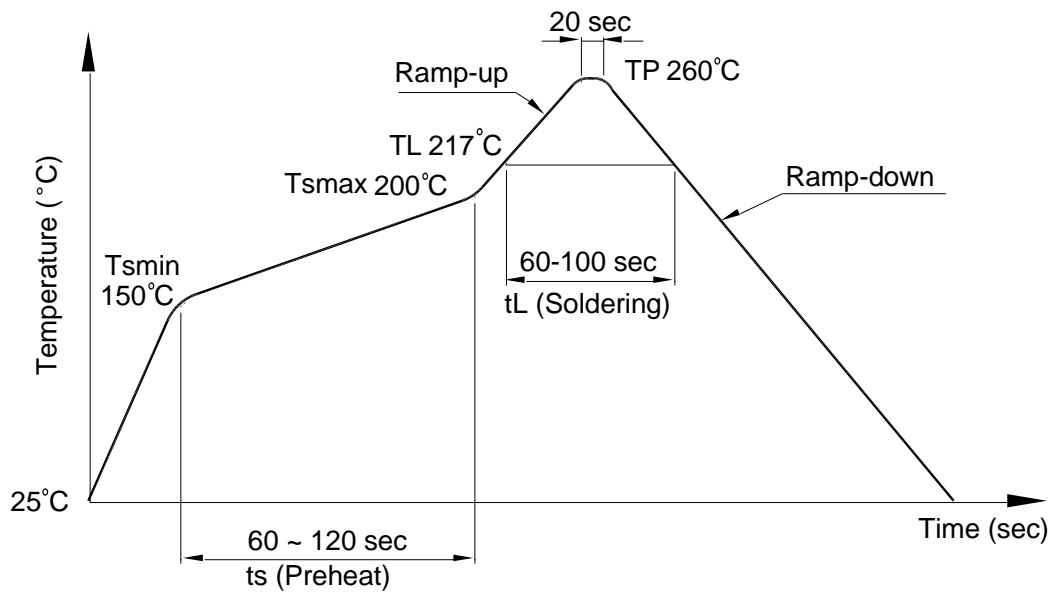

Photocoupler 6N138-L 6N139-L series

9.2 Wave soldering (JEDEC22A111 compliant)

One time soldering is recommended within the condition of temperature.

Temperature: $260 \pm 0 / -5^{\circ}\text{C}$

Time: 10 sec.

Preheat temperature: 25 to 140°C

Preheat time: 30 to 80 sec.

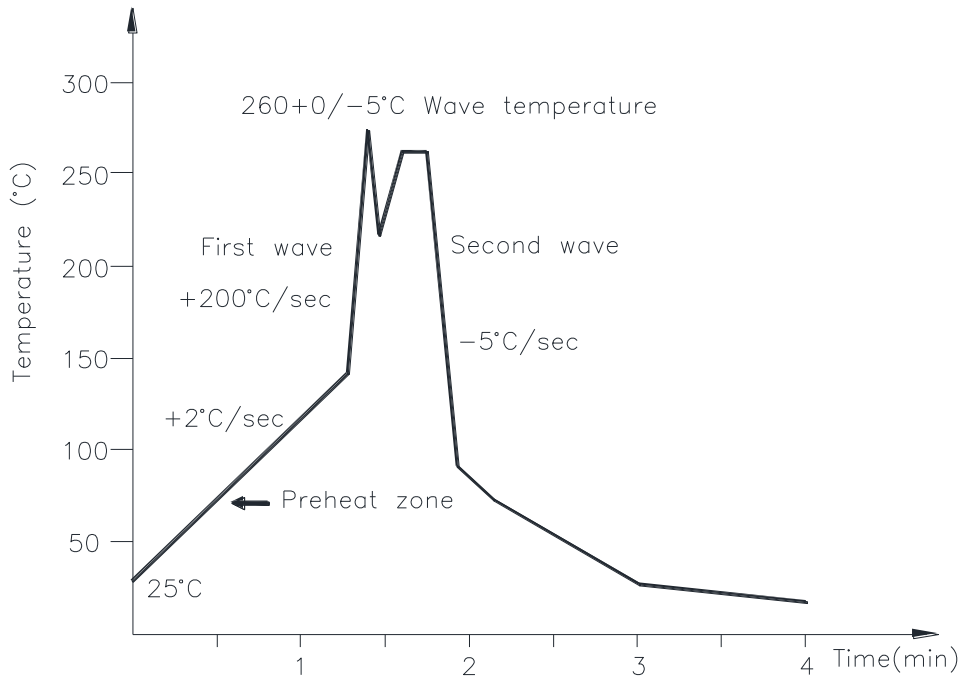

9.3 Hand soldering by soldering iron

Allow single lead soldering in every single process. One time soldering is recommended.

Temperature: $380 \pm 0 / -5^{\circ}\text{C}$

Time: 3 sec max.

**Photocoupler
6N138-L 6N139-L series**

10. RECOMMENDED FOOT PRINT PATTERNS (MOUNT PAD)

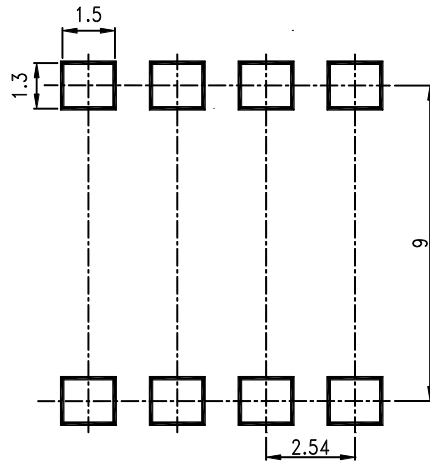

Note :

Dimensions in millimeters.

Photocoupler 6N138-L 6N139-L series

11. NAMING RULE

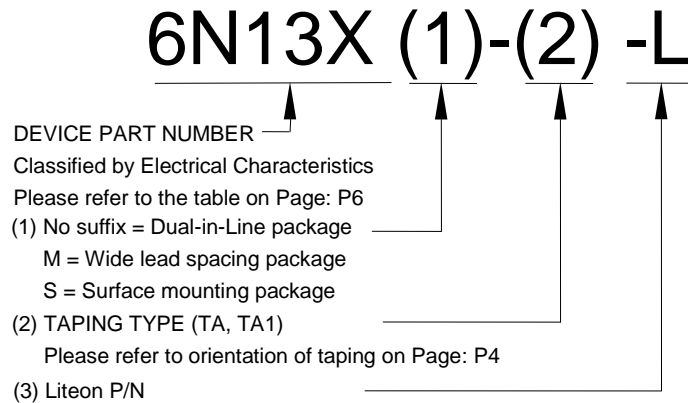

Example : 6N138S-TA1-L , 6N139S-TA1-L

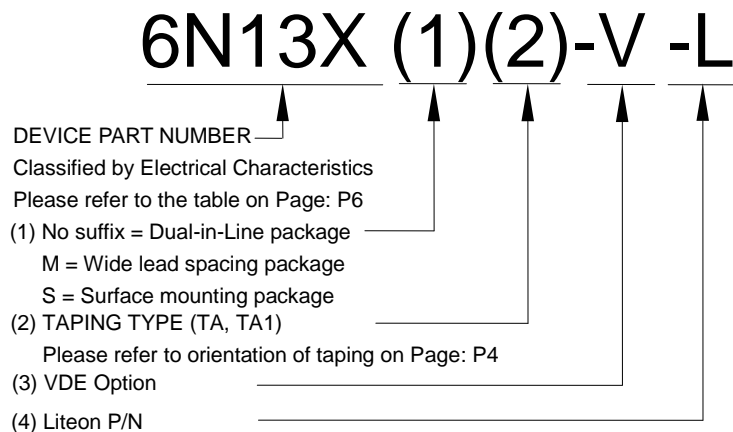

Example : 6N138STA1-V-L , 6N139STA1-V-L

12. NOTES

- LiteOn is continually improving the quality, reliability, function or design and LiteOn reserves the right to make changes without further notices.
- The products shown in this publication are designed for the general use in electronic applications such as office automation equipment, communications devices, audio/visual equipment, electrical application and instrumentation.
- For equipment/devices where high reliability or safety is required, such as space applications, nuclear power control equipment, medical equipment, etc, please contact our sales representatives.
- When requiring a device for any "specific" application, please contact our sales in advice.
- If there are any questions about the contents of this publication, please contact us at your convenience.
- The contents described herein are subject to change without prior notice.
- Immerge unit's body in solder paste is not recommended.