

# DATA SHEET

PART NO. : 071-0001-4589

REV: A / 1

PARA LIGHT ENGINEERING: \_\_\_\_\_

CUSTOMER'S APPROVAL: \_\_\_\_\_

DCC: \_\_\_\_\_

# 1.9\*3.8\*5.0mm RECTANGULAR LED LAMP

071-0001-4589

REV:A / 1

## PACKAGE DIMENSIONS

Note:

- 1.All Dimensions are in millimeters.
- 2.Tolerance is  $\pm 0.25\text{mm}(0.010\text{ ''})$   
Unless otherwise specified.
3. highlight <1500V the led can  
withstand the max static level when  
assembling or operation (HBM)

ITEM	MATERIALS
RESIN	Epoxy Resin
LEAD FRAME	Sn Plating iron Alloy

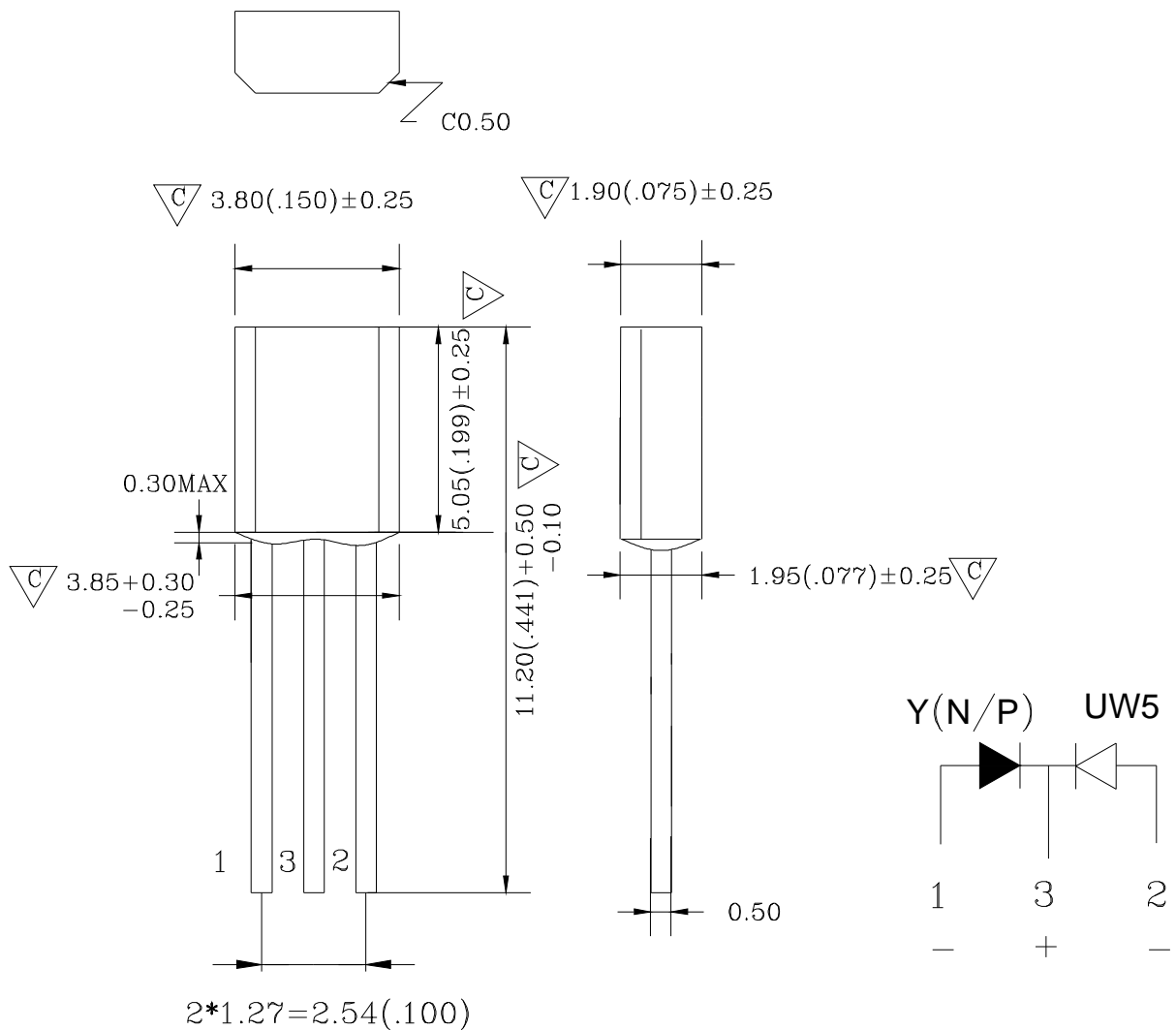

# 1.9\*3.8\*5.0mm RECTANGULAR LED LAMP

071-0001-4589

REV:A / 1

## FEATURES

- \* High-brightness
- \* High reliability
- \* Low-voltage characteristics
- \* Wide Viewing Angle
- \* Pb FREE Products
- \* RoHS Compliant

## CHIP MATERIALS

- \* Dice Material : GaInN& GaAlInP/Si
- \* Light Color : MULTICOLOR (COOL WHITE & AMBER)
- \* Lens Color : WHITE DIFFUSED

## Note:

- \*Two color LED respectively can withstand the maximum voltage less than 5V and not burned, if just for 5V after a period of time two LED colors will be burned
- \*The working current of the LED 3 in two color are 10~20mA
- \*Two color LED respectively can bear 30mA and not burned, but greater than 30mA two color LED will be burned

## ABSOLUTE MAXIMUM RATING:(Ta=25°C)

SYMBOL	DESCRIPTION	COOL WHITE	AMBER	UNIT
P <sub>D</sub>	Power Dissipation	120	85	mW
V <sub>R</sub>	Reverse Voltage	5	5	V
I <sub>F</sub>	Average Forward Current	30	30	mA
I <sub>PF</sub>	Peak Forward Current (Duty=0.1,1KHZ)	-	80	mA
-	Derating Linear From 25°C	0.4	0.4	mA/°C
T <sub>opr</sub>	Operating Temperature Range	-25°C to 85°C		
T <sub>stg</sub>	Storage Temperature Range	-25°C to 85°C		

IFP Condition : Pulse Width≤10msec, 10% duty cycle

## ELECTRO-OPTICAL CHARACTERISTICS:(Ta=25°C)

SYMBOL	PARAMETER	TEST CONDITION	MIN.	TYP.	MAX.	UNIT	
V <sub>F</sub>	Forward Voltage	I <sub>F</sub> =20mA	Cool White	2.7	3.3	3.7	V
			Amber		2.1	2.6	V
I <sub>D</sub>	Dominant Wavelength	I <sub>F</sub> =20mA	Amber	585		596	nm
ΔI	Spectral Line Half – Width	I <sub>F</sub> =20mA	Amber		30		nm
2θ <sub>1/2</sub>	Half Intensity Angle	I <sub>F</sub> =20mA	Cool White		100		deg
			Amber		100		deg
I <sub>V</sub>	Luminous Intensity	I <sub>F</sub> =20mA	Cool White	300	600	1050	mcd
			Amber	100	250	400	mcd
X	Chromaticity Coordinates	I <sub>F</sub> =20mA	Cool White		0.28		
Y		I <sub>F</sub> =20mA			0.27		

# 1.9\*3.8\*5.0mm RECTANGULAR LED LAMP

071-0001-4589

REV:A / 1

■  $T_J = 25^\circ\text{C}$

Forward Current Vs Forward Voltage

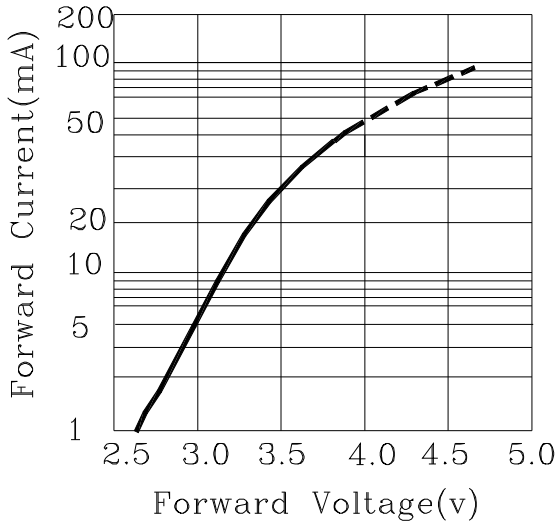

■  $T_a = 25^\circ\text{C}$

Luminous Intensity VS. Forward Current (Mcd)

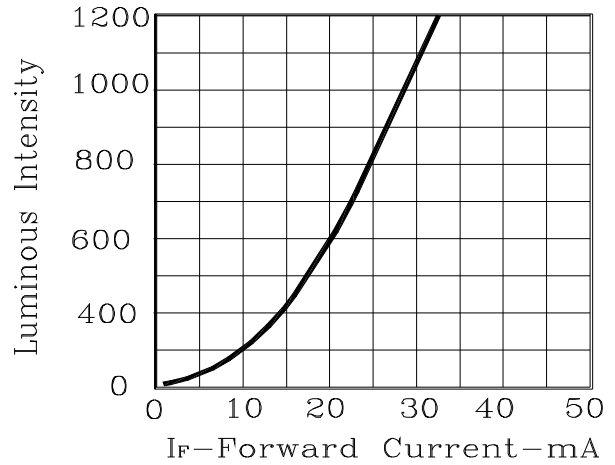

■ Duty Ratio vs. Allowable Forward Current

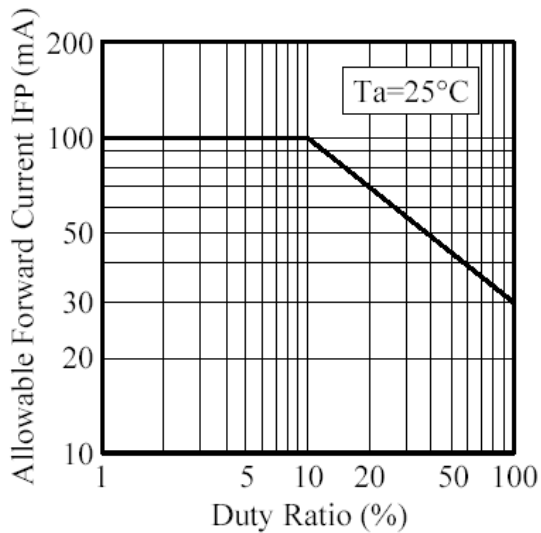

■ Ambient Temperature vs. Forward Voltage

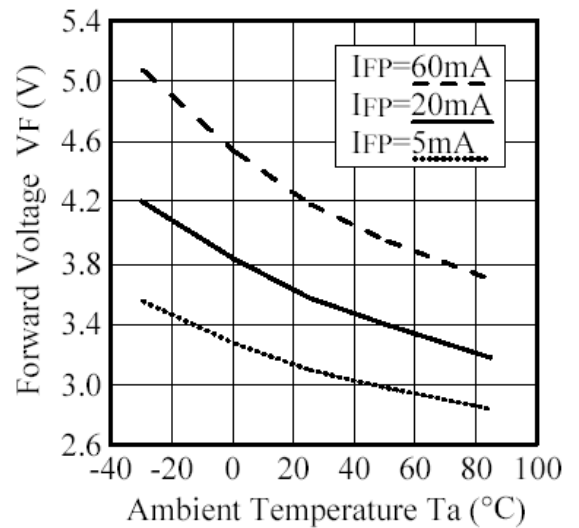

# 1.9\*3.8\*5.0mm RECTANGULAR LED LAMP

071-0001-4589

REV:A / 1

■ Ambient Temperature vs. Relative Luminosity

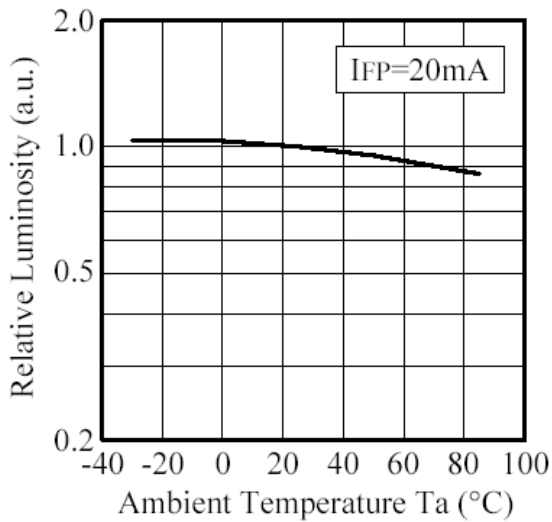

■ Ambient Temperature vs. Allowable Forward Current

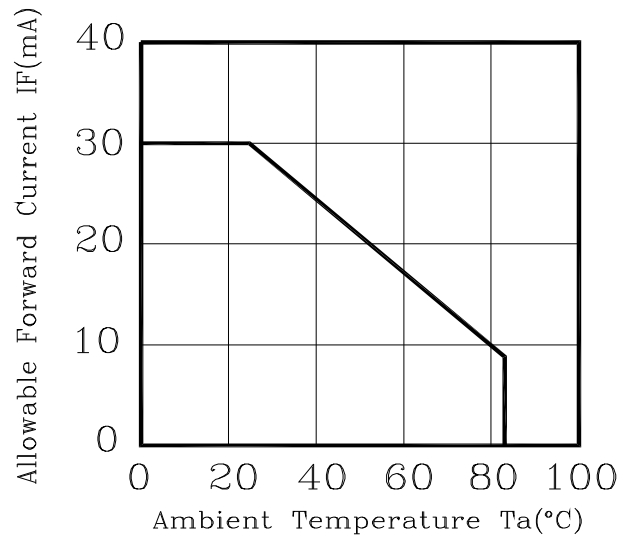

■ Forward Current vs. Chromaticity Coordinate

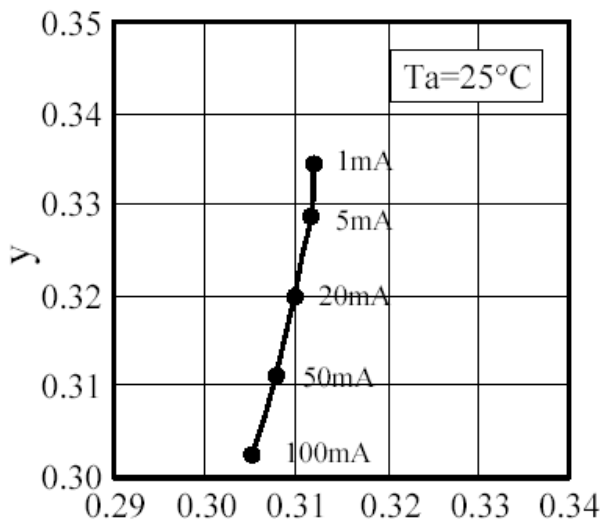

■ Spectrum

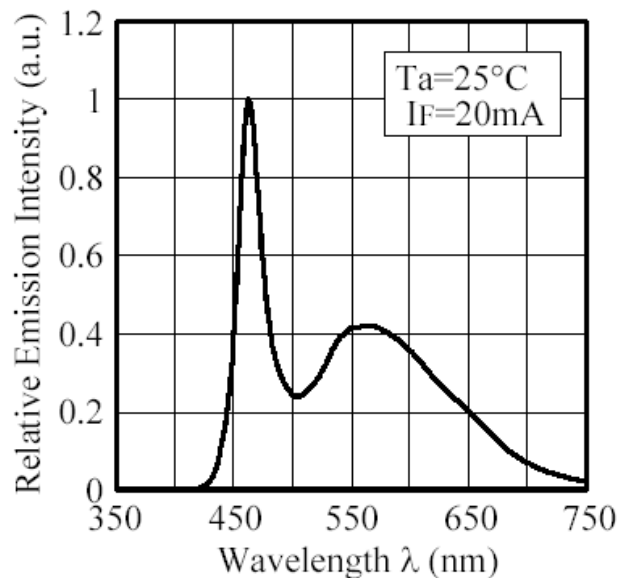

**UW5**

**-VIEWING ANGLE**

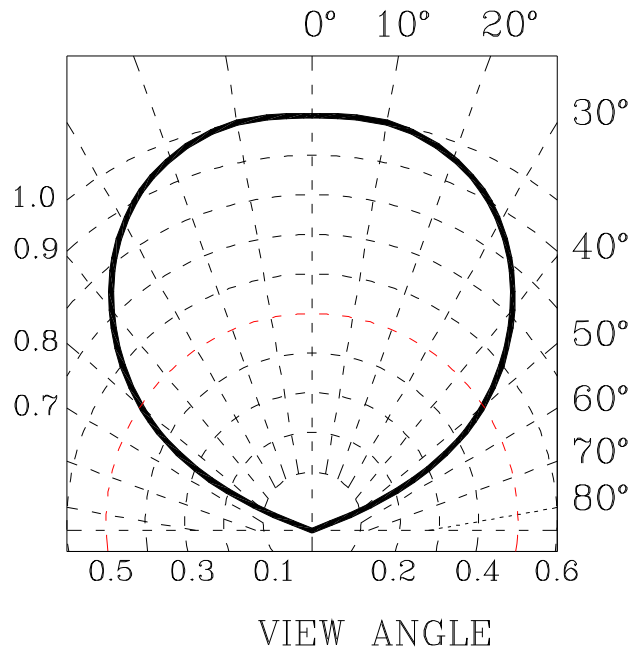

# 1.9\*3.8\*5.0mm RECTANGULAR LED LAMP

071-0001-4589

REV:A / 1

## Amber

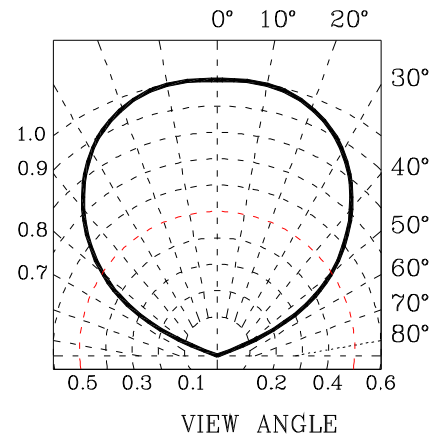
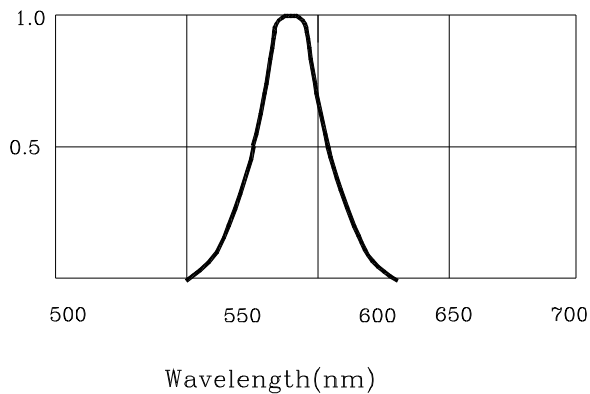
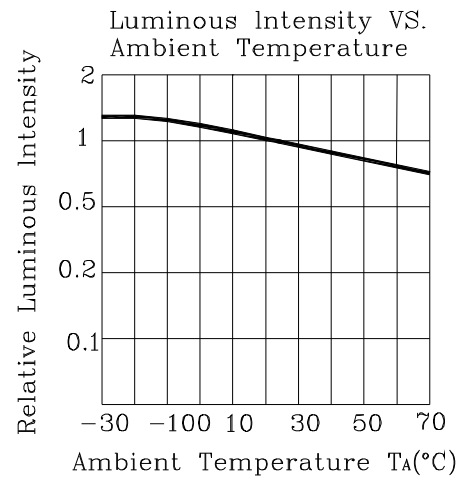
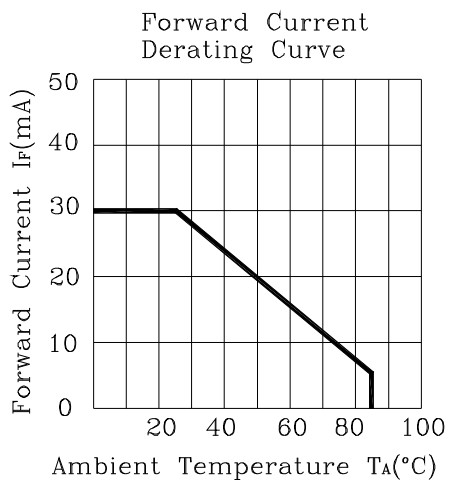
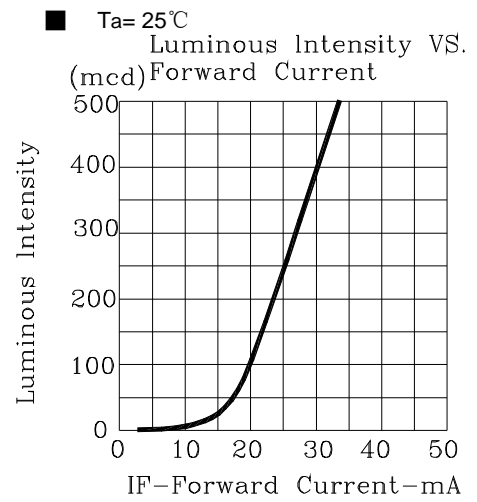
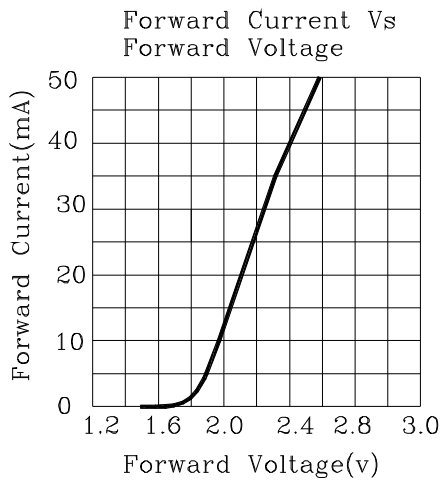

1.9\*3.8\*5.0mm RECTANGULAR LED LAMP

071-0001-4589

REV:A / 1

Label Explanation

PART NO. :	
LOT NO. :	INSPECTED
BIN :	
Q' TY :	PCS
N. W :	g

PARA NO. : 071-0001-4589

Refer to page 17

LOT NO. : E L L 4 7 0009

A B C D E F

A---E: For Serial number

B---L: Local F: Foreign

C---L: LAMP

D---Year

E---Month

F---Serial number



# 1.9\*3.8\*5.0mm RECTANGULAR LED LAMP

071-0001-4589

REV:A / 1

## SOLDERING

METHOD	SOLDERING CONDITIONS	REMARK
DIP SOLDERING	Bath temperature: 260°C Immersion time: with 5 sec ,1times	– Solder no closer than 3mm from the base of the package – Using soldering flux, "RESIN FLUX" is recommended.
SOLDERING IRON	Soldering iron: 30W or smaller Temperature at tip of iron: 300°C or lower Soldering time: min 3 sec.	– During soldering, take care not to press the tip of iron against the lead. (To prevent heat from being transferred directly to the lead, hold the lead with a pair of tweezers while soldering)

1) When soldering the lead of LED in a condition that the package is fixed with a panel (See Fig.1), be careful not to stress the leads with iron tip.

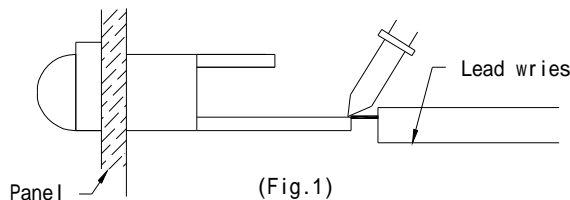

2) When soldering wire to the lead, work with a jig (See Fig.2) to avoid stressing the package.

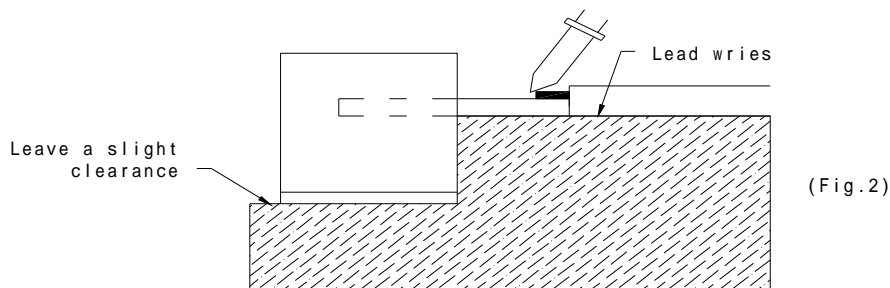

Regarding tinning the leads, compound made of tin ,copper and silver is proposed with the temperature of 260°C. The proportion of the alloyed solution is 95.5% tin, 3.5 % copper, 0.5% silver. The time of tinning is 3 seconds.

# 1.9\*3.8\*5.0mm RECTANGULAR LED LAMP

071-0001-4589

REV:A / 1

- 3) Similarly, when a jig is used to solder the LED to PC board, take care as much as possible to avoid stressing the leads (See Fig.3).

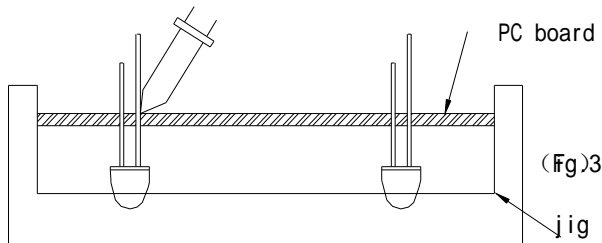

- 4) Repositioning after soldering should be avoided as much as possible. If inevitable: select a best-suited method that assures the least stress to the LED.
- 5) Lead cutting after soldering should be performed only after the LED temperature has returned to normal temperature.

## — STORAGE

- 1) The LEDs should be stored at 30°C or less and 70% RH or less after being shipped from PARA and the storage life limit is 1 year .
- 2) PARA LED lead frames are comprised of a tin plated iron alloy. The surface may be affected by environments which contain corrosive gases and so on. Please avoid conditions which may cause the LEDs to corrode, tarnish or discolor. This corrosion or discoloration may cause difficulty during soldering operations. It is recommended that the LEDs be used as soon as possible.
- 3) Please avoid rapid changes in ambient temperature, especially, in high humidity environments where condensation can occur.

**— STATIC ELECTRICITY**

- 1) Static electricity or surge voltage damages the LEDs.  
It is recommended that a wrist band and an anti-electrostatic glove be used when handling the LEDs.
- 2) All devices, equipment and machinery must be properly grounded. It is recommended that measures be taken against surge voltage to the LED mounting equipment.
- 3) When inspecting the final products in which LEDs were assembled, it is recommended to check whether the assembled LEDs are damaged by static electricity. To find static-damaged LEDs, perform a light-on test or a VF test at a lower current (below 1mA is recommended).
- 4) Damaged LEDs will show some unusual characteristics such as the leakage current remarkably increases, the forward voltage becomes lower, or the LEDs do not light at the low current.

Criteria : (  $VF > 2.0V$  at  $IF = 0.5mA$  )

**— LED MOUNTING METHOD**

- 1) When mounting the LED to a housing, as shown on Fig.4, ensure that the mounting holes on the PC board match the pitch of the leads correctly. Tolerance of dimensions of the respective components including the LEDs should be taken into account especially when designing the housing, PC board, etc. to prevent pitch misalignment between the leads and holes on PCB, the diameter of the holes should be slightly larger than the size of the lead. Alternatively, the shape of the holes could be made oval. (See Fig.4)

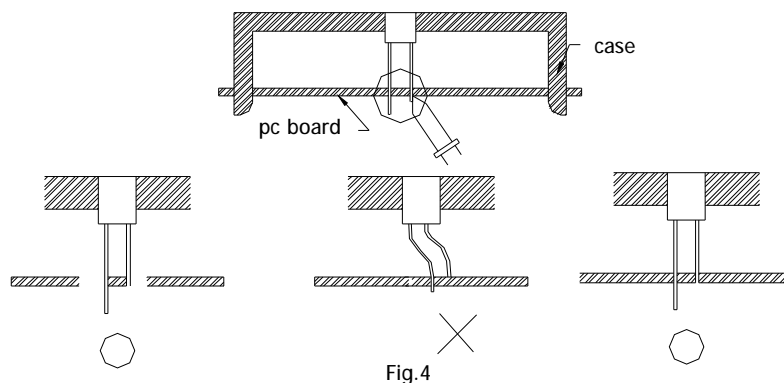

# 1.9\*3.8\*5.0mm RECTANGULAR LED LAMP

071-0001-4589

REV:A / 1

- 2) Use LEDs with stand-off (Fig.5) or the tube or spacer made of plastic (Fig.6) to position the LEDs.

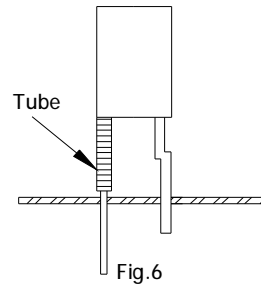
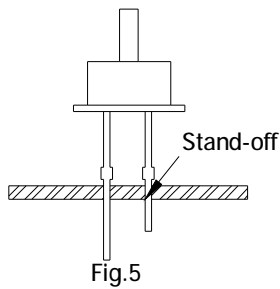

## FORMING LEAD

- 1) The lead should be bent at least 2mm away from the package. Bending should be performed with base fixed to a jig or pliers (Fig.7)

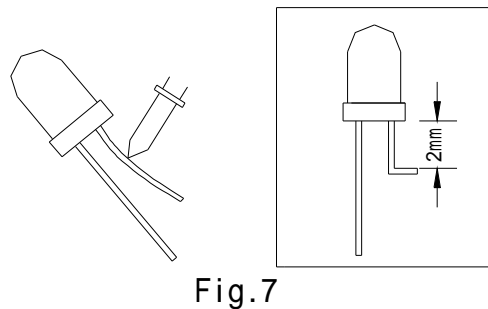

- 2) Forming lead should be carried out prior to soldering and never during or after soldering.  
3) Form the lead to ensure alignment between the leads and the holes on PCB, so that stress against the LED is prevented. (Fig.8)

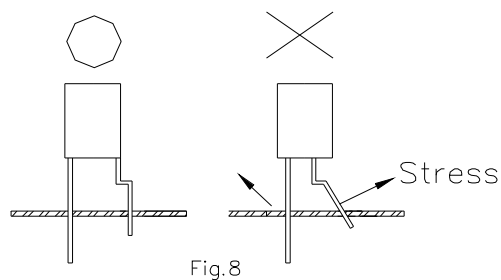

**—LEAD STRENGTH**

## 1) Bend strength

Do not bend the lead more than twice. (Fig.9)

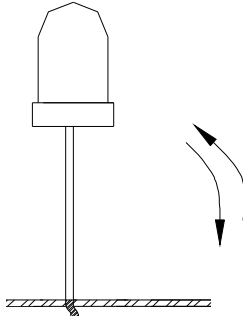

Fig.9

## 2) Tensile strength (@Room Temperature)

If the force is 1kg or less, there will be no problem. (Fig.10)



Fig.10

**—HEAT MANAGEMENT**

- 1) Thermal design of the end product is of paramount importance. Please consider the heat generation of the LED when designing the system. The temperature increase is affected by the thermal resistance of the circuit board and density of LED placement on the board, as well as other components. It is necessary to avoid intense heat generation and operate within the maximum ratings given in this specification.
- 2) The operating current (If) should be decided after considering the ambient maximum temperature of LEDs.

# 1.9\*3.8\*5.0mm RECTANGULAR LED LAMP

071-0001-4589

REV:A / 1

## —CHEMICAL RESISTANCE

- 1) Avoid exposure to chemicals as it may attack the LED surface and cause discoloration.
- 2) When washing is required, refer to the following table for the proper chemical to be used.  
(Immersion time: within 3 minutes at room temperature.)

SOLVENT	ADAPTABILITY
Freon TE	⊙
Chloroethene	×
Isopropyl Alcohol	⊙
Thinner	×
Acetone	×
Trichloroethylene	×

NOTE: Influences of ultrasonic cleaning of the LED resin body differ depending on factors such as the oscillator output, size of the PC board and the way in which the LED is mounted. Therefore, ultrasonic cleaning should only be performed by confirming an ultrasonic cleaning trial run.

⊙--Usable    ×--Do not use.

## —OTHER CONSIDERTIONS

- 1) Care must be taken to ensure that the reverse voltage will not exceed the absolute maximum rating when using the LEDs with matrix drive.
- 2) The LEDs described in this data sheet are intended to be used for ordinary electronic equipment (such as office equipment, communications equipment, measurement instruments and household appliances). Consult PARA's sales staff in advance for information on the applications in which exceptional quality and reliability are required , particularly when the failure or malfunction of the LEDs may directly jeopardize life or health (such as for airplanes, spacecraft, automobiles, traffic control equipment etc).
- 3) The formal specifications must be exchanged and signed by both parties before large volume purchase begins.

1.9\*3.8\*5.0mm RECTANGULAR LED LAMP

071-0001-4589

REV:A / 1

Bin Code List:

Luminous Intensity(IV), Unit:mcd@20mA		
Bin Code(UW5)	Min	Max
L	300	520
M	520	680
N	680	880
P	880	1050

Tolerance of each bin are  $\pm 15\%$

XY Chromaticity

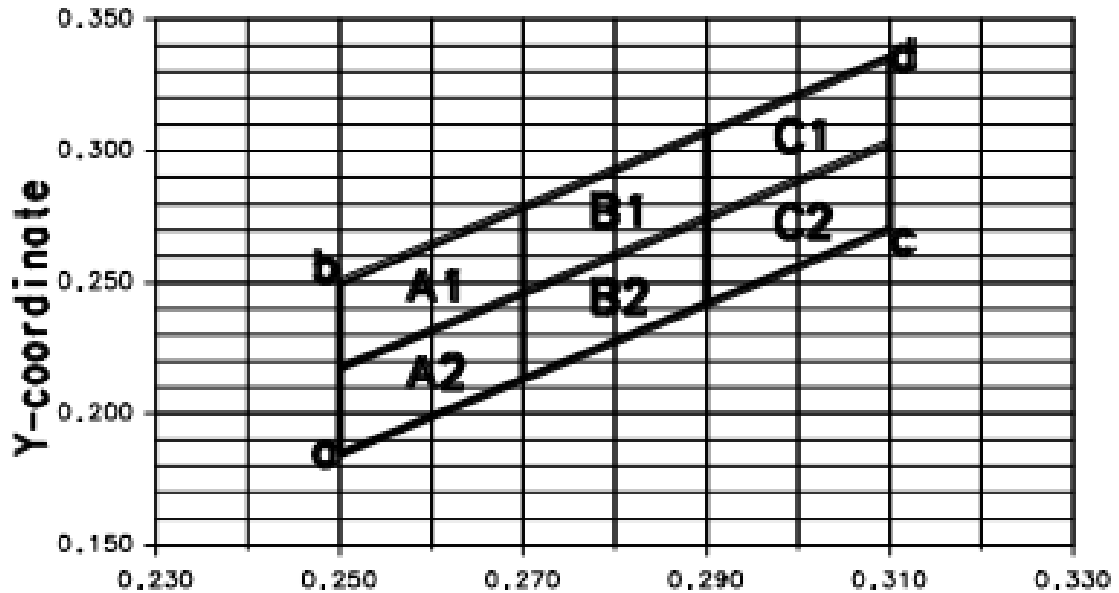

**X-coordinate**  
WHITE COLOR BINNING STRUCTURE

	Bin	Spec.Range							
	Code	x <sub>1</sub>	y <sub>1</sub>	X <sub>2</sub>	Y <sub>2</sub>	X <sub>3</sub>	Y <sub>3</sub>	X <sub>4</sub>	Y <sub>4</sub>
White	A1	0.2700	0.2455	0.2700	0.2780	0.2500	0.2500	0.2500	0.2175
	A2	0.2700	0.2455	0.2700	0.2130	0.2500	0.1850	0.2500	0.2175
	B1	0.2700	0.2455	0.2700	0.2780	0.2900	0.3060	0.2900	0.2735
	B2	0.2700	0.2455	0.2700	0.2130	0.2900	0.2410	0.2900	0.2735
	C1	0.2900	0.3060	0.3100	0.3355	0.3100	0.3030	0.2900	0.2735
	C2	0.2900	0.2410	0.3100	0.2705	0.3100	0.3030	0.2900	0.2735

COLOR MEASUREMENT ALLOWANCE IS $\pm$ 0.01



# 1.9\*3.8\*5.0mm RECTANGULAR LED LAMP

071-0001-4589

REV:A / 1

## LED Lamps: Part Number Rules

