

由 Autodesk 教育版产品制作

|      |              |      |
|------|--------------|------|
| MAPX | MODIFICATION | DATE |
|------|--------------|------|

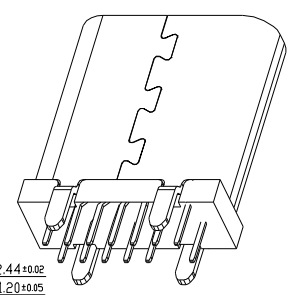

- SPECIFICATIONS:
- ELECTRICAL CHARACTERISTICS:
    - 1-1. CONTACT RESISTANCE: 30mΩ MAX.
    - 1-2. DIELECTRIC WITHSTANDING VOLTAGE: 100V AC FOR ONE MINUTE.
    - 1-3. INSULATION RESISTANCE: 100MΩ MIN. MEASURED BY 500 VDC
  - MECHANICAL CHARACTERISTICS:
    - 2-1. INSERTION FORCE :0.5-2.0kgf<REF.>
    - 2-2. WITHDRAWAL FORCE :0.8-2.0kgf<REF.>
  - LIFE TEST: 10,000 CYCLES.
  - TO CONFORM TO THE KRCDNN HAZARDOUS SUBSTANCE FREE SPEC.

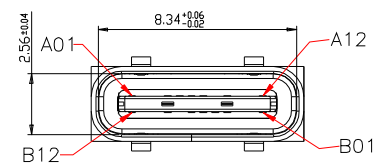
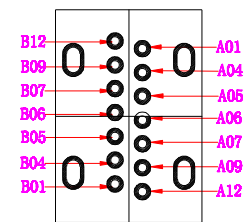
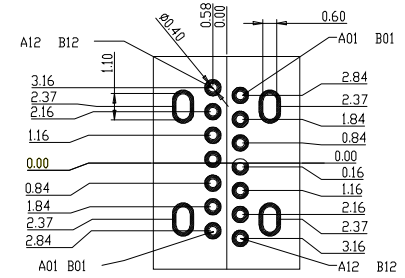
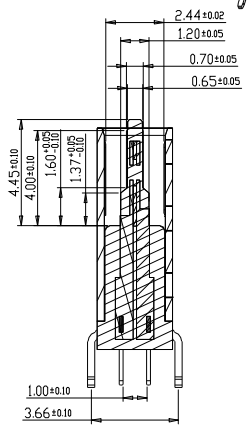
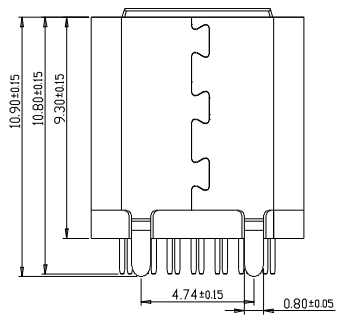

截面 1-1

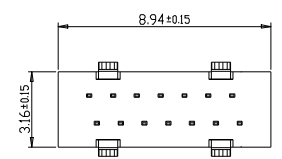

|     |             |     |             |
|-----|-------------|-----|-------------|
| A1  | GND         | B12 | GND         |
| A4  | VBUS        | B9  | VBUS        |
| A5  | CC1         |     |             |
| A6  | DP1         | B7  | DN2         |
| A7  | DN1         | B6  | DP2         |
|     |             | B5  | CC2         |
| A9  | VBUS        | B4  | VBUS        |
| A12 | GND         | B1  | GND         |
| PIN | SIGNAL NAME | PIN | SIGNAL NAME |

|     |                 |                          |              |      |
|-----|-----------------|--------------------------|--------------|------|
| 6   | SHELL           | STAINLESS STEEL          | Ni Plated    | 1PCS |
| 5   | SHIELDING PLATE | STAINLESS STEEL          | ---          | 1PCS |
| 4   | MD              | HIGH TEMPERATURE PLASTIC | BLACK        | 1PCS |
| 3   | CONTACT         | COPPER ALLOY             | Au/Ni Plated | 1SET |
| 2   | CONTACT         | COPPER ALLOY             | Au/Ni Plated | 1SET |
| 1   | HOUSING         | HIGH TEMPERATURE PLASTIC | BLACK        | 1PCS |
| NO. | DESCRIPTION     | MATERIAL                 | REMARKS      | QTY  |

**产品图**  
PRODUCT CHART DWG

**公差一览表**  
TOLERANCE UNLESS OTHERWISE

|      |       |      |       |
|------|-------|------|-------|
| X.   | ±0.30 | X.   | ±5.°  |
| .X   | ±0.25 | .X   | ±2.°  |
| .XX  | ±0.15 | .XX  | ±1.°  |
| .XXX | ±0.10 | .XXX | ±0.5° |

**深州市精拓金电子有限公司**

|             |            |               |      |                          |
|-------------|------------|---------------|------|--------------------------|
| 单位<br>UNITS | MM         | 制图<br>DRAWING | YANG | 制图料号<br>PRODUCT PART NO. |
| 比例<br>SCALE | 1:1        | 审核<br>CHKD    | 郭志富  | 产品名称<br>PRODUCT NO.      |
| 日期<br>DATE  | 2019.11.23 | 核准<br>APPD    | 黄国荣  | 角法<br>VIEW               |
|             |            |               |      | 版本<br>VER                |
|             |            |               |      | AD                       |

TYPE C 14P母座180度 H=9.3