

N-Channel 100-V (D-S) MOSFET

GENERAL DESCRIPTION

The MEE15N10-G is a N-Channel enhancement mode power field effect transistors, using Force-MOS patented Extended Trench Gate(ETG) technology. This advanced technology is especially tailored to minimize on state resistance and gate charge, and enhance avalanche capability. These devices are particularly suited for medium voltage application such as charger, adapter, notebook computer power management and other lighting dimming powered circuits, and low in-line power loss that are needed in a very small outline surface mount package.

PIN CONFIGURATION

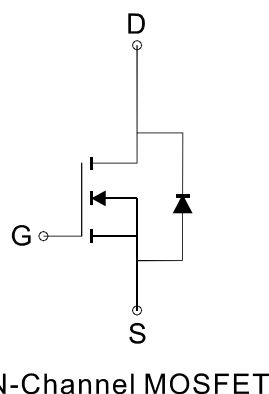
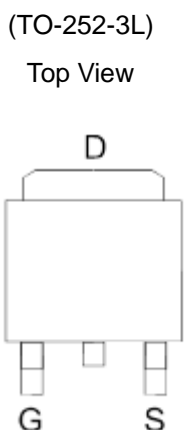

FEATURES

- $R_{DS(ON)} \leq 100m\Omega @ V_{GS}=10V$
- Super high density cell design for extremely low $R_{DS(ON)}$
- Exceptional on-resistance and maximum DC current capability

APPLICATIONS

- Power Management
- Synchronous Rectification
- Load Switch

Ordering Information: MEE15N10-G (Green product-Halogen free)

Absolute Maximum Ratings (Tc=25°C Unless Otherwise Noted)

Parameter	Symbol	Maximum Ratings	Unit
Drain-Source Voltage	V_{DS}	100	V
Gate-Source Voltage	V_{GS}	± 20	V
Continuous Drain Current	I_D	$T_c=25^\circ C$	15.4
		$T_c=70^\circ C$	12.3
Pulsed Drain Current	I_{DM}	62	A
Maximum Power Dissipation	P_D	$T_c=25^\circ C$	37.9
		$T_c=70^\circ C$	24.2
Junction and Storage Temperature Range	T_J, T_{stg}	-55 to 150	$^\circ C$
Thermal Resistance-Junction to Case *	$R_{\theta JC}$	3.3	$^\circ C/W$

* The device mounted on 1in² FR4 board with 2 oz copper



N-Channel 100-V (D-S) MOSFET

Electrical Characteristics (T_c = 25°C Unless Otherwise Specified)

Symbol	Parameter	Limit	Min	Typ	Max	Unit
STATIC						
BV _{DSS}	Drain-Source Breakdown Voltage	V _{GS} =0V, I _D =250 μA	100			V
V _{GS(th)}	Gate Threshold Voltage	V _{DS} =V _{GS} , I _D =250 μA	1		3	V
I _{GSS}	Gate Leakage Current	V _{DS} =0V, V _{GS} =±20V			±100	nA
I _{DSS}	Zero Gate Voltage Drain Current	V _{DS} =100V, V _{GS} =0V			1	μA
R _{DS(ON)}	Drain-Source On-Resistance ^a	V _{GS} =10V, I _D =8A		80	100	mΩ
V _{SD}	Diode Forward Voltage	I _S =8A, V _{GS} =0V		0.9	1.1	V
DYNAMIC						
Q _g	Total Gate Charge	V _{DS} =50V, V _{GS} =10V, I _D =8A		15.5		nC
Q _{gs}	Gate-Source Charge			2.6		
Q _{gd}	Gate-Drain Charge			3.6		
C _{iss}	Input Capacitance	V _{DS} =15V, V _{GS} =0V, f=1MHz		314		pF
C _{oss}	Output Capacitance			119		
C _{rss}	Reverse Transfer Capacitance			15		
t _{d(on)}	Turn-On Delay Time	V _{DS} =50V, R _L =50Ω, V _{GS} =10V, R _G =1Ω I _D =1A		8.4		ns
t _r	Turn-On Rise Time			24.8		
t _{d(off)}	Turn-Off Delay Time			30.7		
t _f	Turn-Off Fall Time			2.5		
T _{rr}	Reverse Recovery Time	I _D =7A, V _{GS} =0V, di/dt=100A/us		25		ns
Q _{rr}	Reverse Recovery Charge			24		nC

Notes: a. Pulse test: pulse width ≤ 300us, duty cycle ≤ 2%, Guaranteed by design, not subject to production testing.

b. Matsuki Electric/ Force mos reserves the right to improve product design, functions and reliability without notice.



N-Channel 100-V (D-S) MOSFET

Typical Characteristics (T_J =25°C Noted)

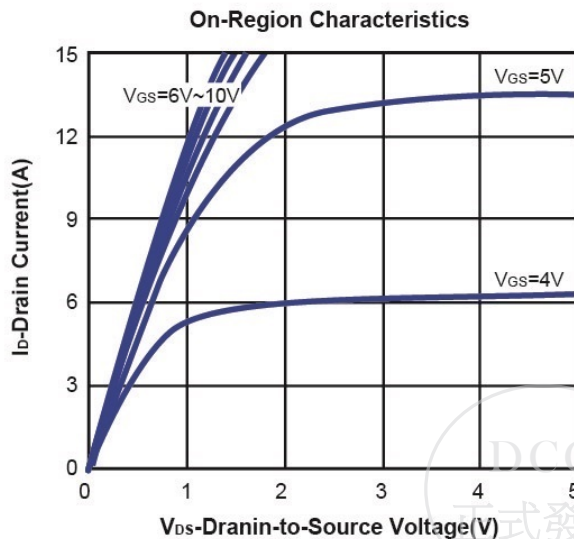
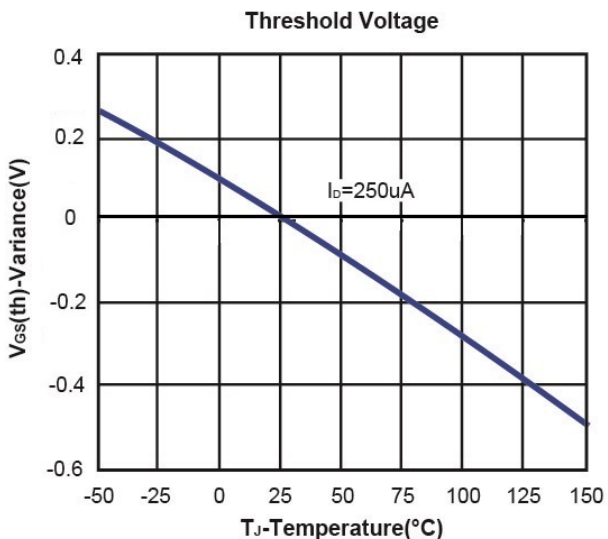
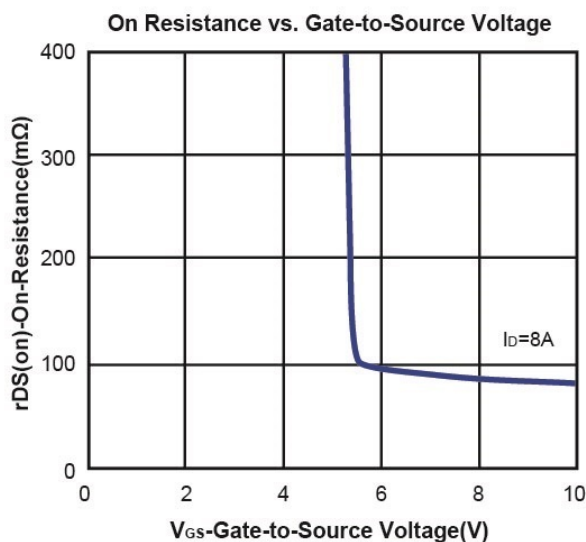
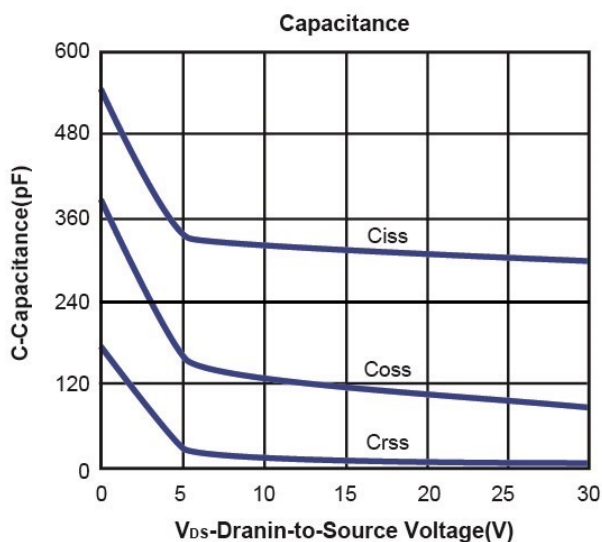
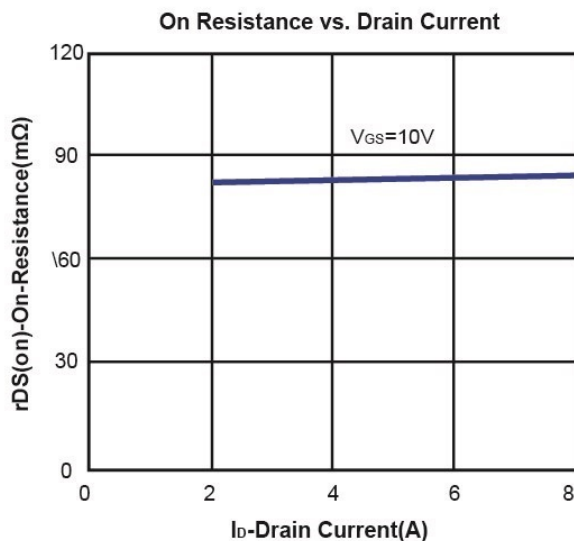
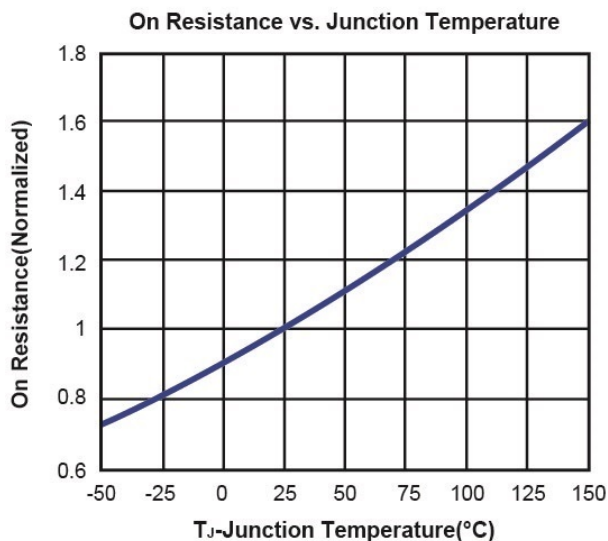

N-Channel 100-V (D-S) MOSFET

Typical Characteristics (T_J =25°C Noted)

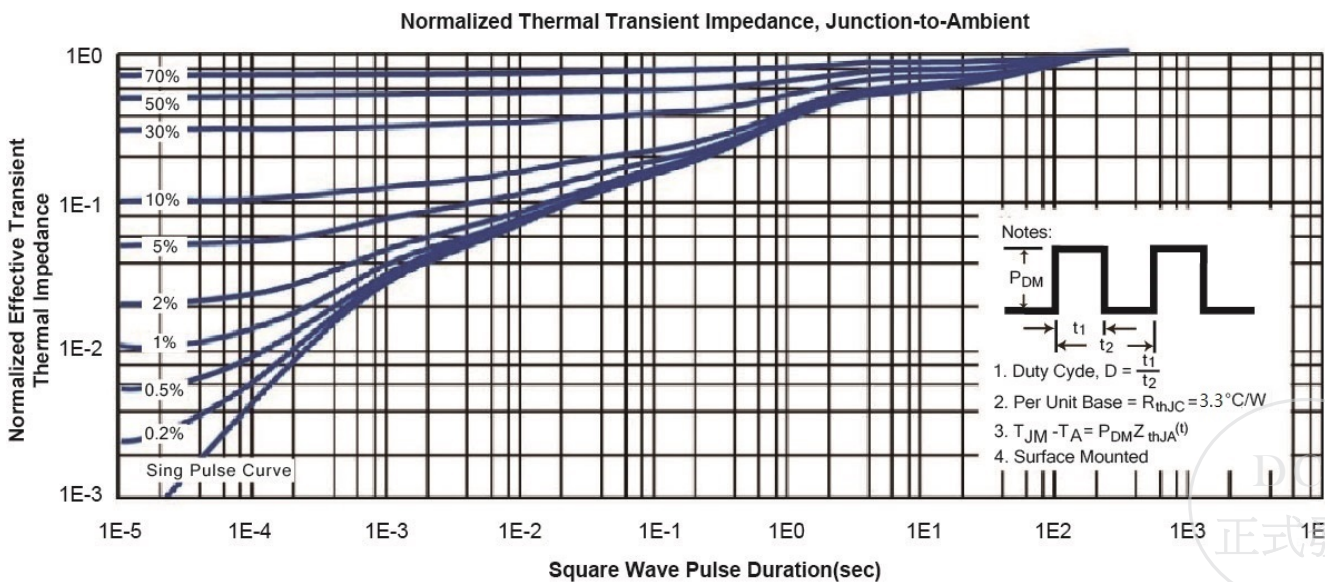
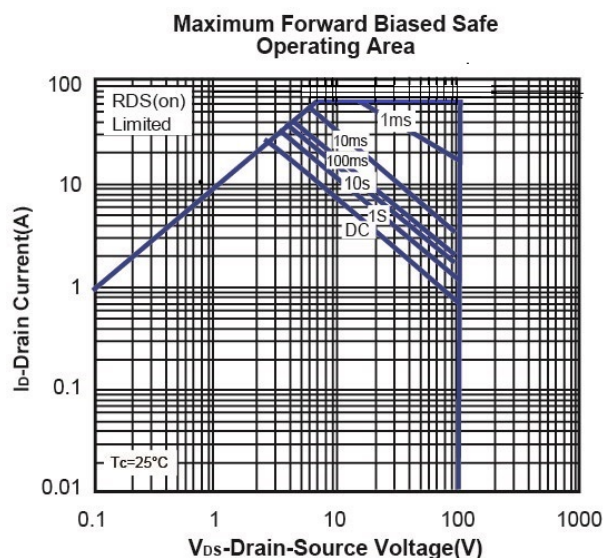
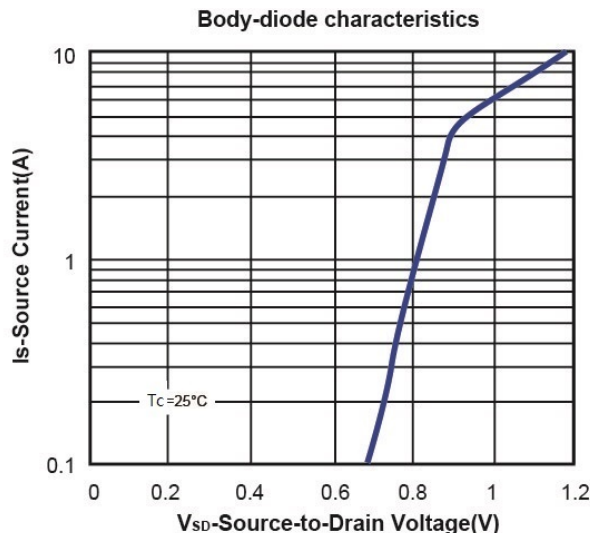
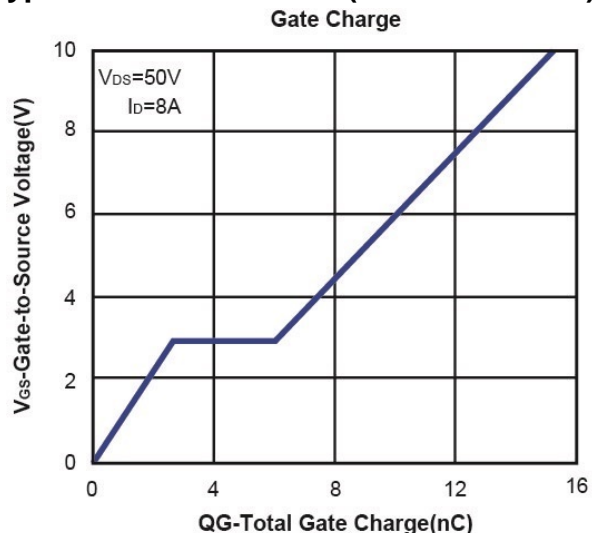

TO252-3L Package Outline

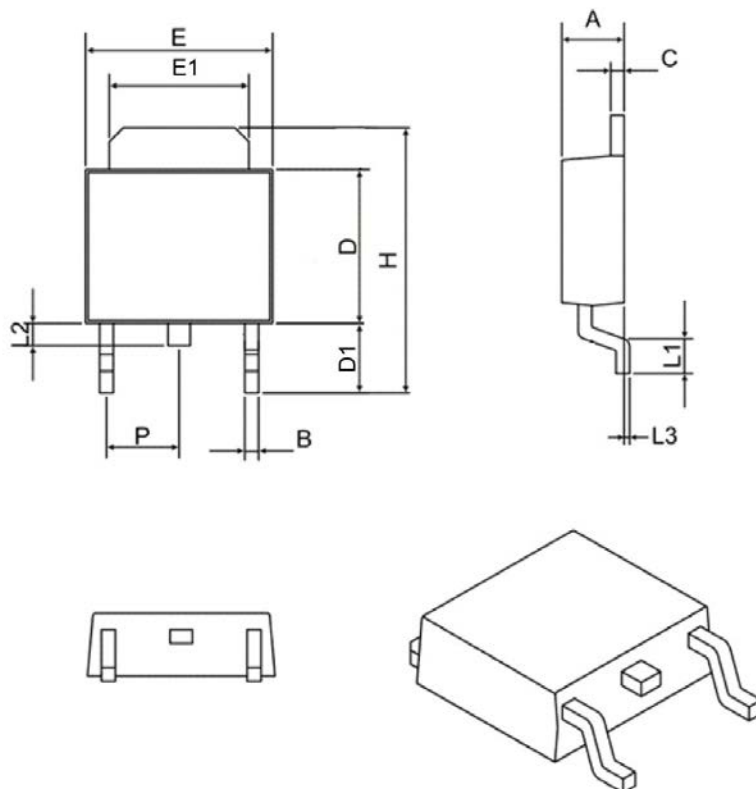

SYMBOL	MIN	MAX
A	2.10	2.50
B	0.40	0.90
C	0.40	0.90
D	5.30	6.30
D1	2.20	2.90
E	6.30	6.75
E1	4.80	5.50
L1	0.90	1.80
L2	0.50	1.10
L3	0.00	0.20
H	8.90	10.40
P	2.30 BSC	

