

Advanced Power Top View LEDs A09KU-NP56B64DEBFA2638Z15-1T0T-AM

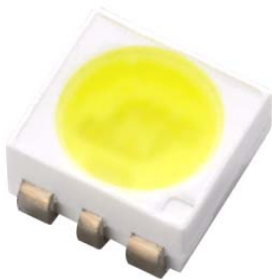

Features

- P-LCC-6 package
- Small package with high efficiency
- Colorless clear resin
- Wide viewing angle 120°
- Qualification according to AEC-Q101 rev. C
- IR reflow or wave soldering

Applications

- Automotive Lighting Interior and Exterior.
- Signal and Symbol Luminary.
- Commercial and Industrial Illumination.
- Backlight: LCD, Switches, Push buttons.

Absolute Maximum Ratings (Ta=25°C)

Parameter	Symbol	Rating	Unit
Forward Current	I_F	250	mA
Peak Forward Current (Duty 1/10 @1KHz)	I_{FP}	450	mA
Power Dissipation	P_d	950	mW
Junction Temperature	T_j	150	°C
Operating Temperature	T_{opr}	-40 ~ +100	°C
Storage Temperature	T_{stg}	-40 ~ +110	°C
Thermal Resistance	$R_{th\ J-A}$	90	K/W
	$R_{th\ J-S}$	40	K/W
ESD (Classification acc. AEC Q101)	ESD_{HBM}	2000	V
	ESD_{MM}	200	V
Soldering Temperature	T_{sol}	Reflow Soldering : 260 °C for 30 sec. Hand Soldering : 350 °C for 3 sec.	

EVERLIGHT

Electro-Optical Characteristics (Ta=25°C)

Parameter	Symbol	Min.	Typ.	Max.	Unit	Condition
Luminous Intensity	I _v	9000	---	14000	mcd	I _F =150mA
Viewing Angle	2θ _{1/2}	-----	120	-----	deg	I _F =150mA
Forward Voltage	V _F	2.6	----	3.8	V	I _F =150mA

Note:

1. Tolerance of Luminous Intensity: ±11%
2. Tolerance of Dominant Wavelength: ±1nm
3. Tolerance of Forward Voltage: ±0.1V

Bin Range of Luminous Intensity

Bin Code	Min.	Max.	Flux(lm) typ	Unit	Condition
EB	9000	11200	30	mcd	I _F =150mA
FA	11200	14000	37		

Bin Range of Forward Voltage

Bin Code	Min.	Max.	Unit	Condition
A6-1	2.60	2.80	V	I _F =150mA
A6-2	2.80	3.00		
A6-3	3.00	3.20		
A6-4	3.20	3.40		
A6-5	3.40	3.60		
A6-6	3.60	3.80		

The C.I.E. 1931 Chromaticity Diagram

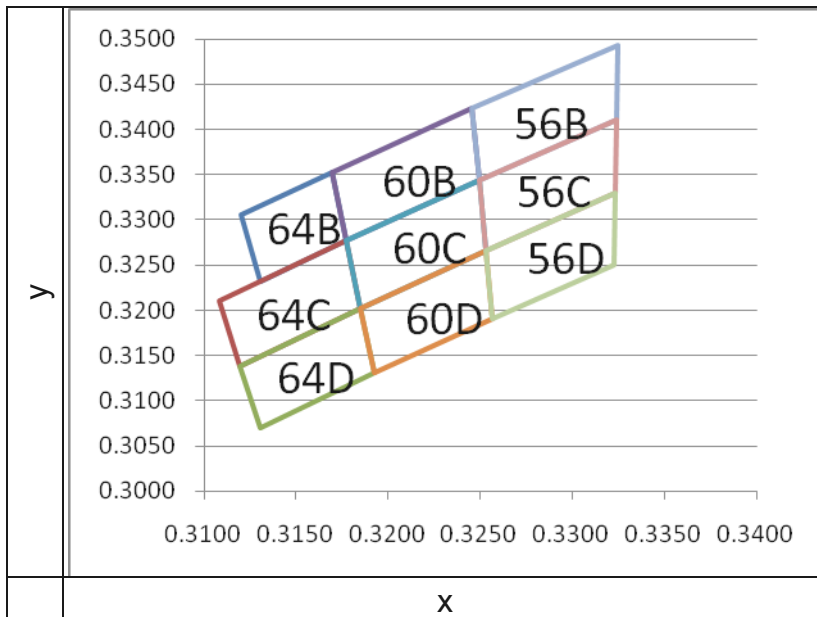

EVERLIGHT

Bin Range of Chromaticity Coordinates Specifications

Bin Code	CIE_x	CIE_y	Condition
64B	0.312	0.3306	I _F =150mA
	0.3169	0.3353	
	0.3177	0.3277	
	0.3131	0.3232	
64C	0.3109	0.3211	
	0.3177	0.3277	
	0.3185	0.3203	
64D	0.312	0.3139	
	0.312	0.3139	
	0.3185	0.3203	
	0.3192	0.3131	
60B	0.3131	0.307	
	0.3169	0.3353	
	0.3246	0.3424	
	0.3249	0.3344	
	0.3177	0.3277	
60C	0.3177	0.3277	
	0.3249	0.3344	
	0.3253	0.3266	
	0.3185	0.3203	
60D	0.3185	0.3203	
	0.3253	0.3266	
	0.3256	0.3191	
	0.3192	0.3131	
56B	0.3246	0.3424	
	0.3325	0.3493	
	0.3324	0.341	
	0.3249	0.3344	
56C	0.3249	0.3344	
	0.3324	0.341	
	0.3323	0.3329	
	0.3253	0.3266	
56D	0.3253	0.3266	
	0.3323	0.3329	
	0.3323	0.3251	
	0.3256	0.3191	

Typical Electro-Optical Characteristics Curves

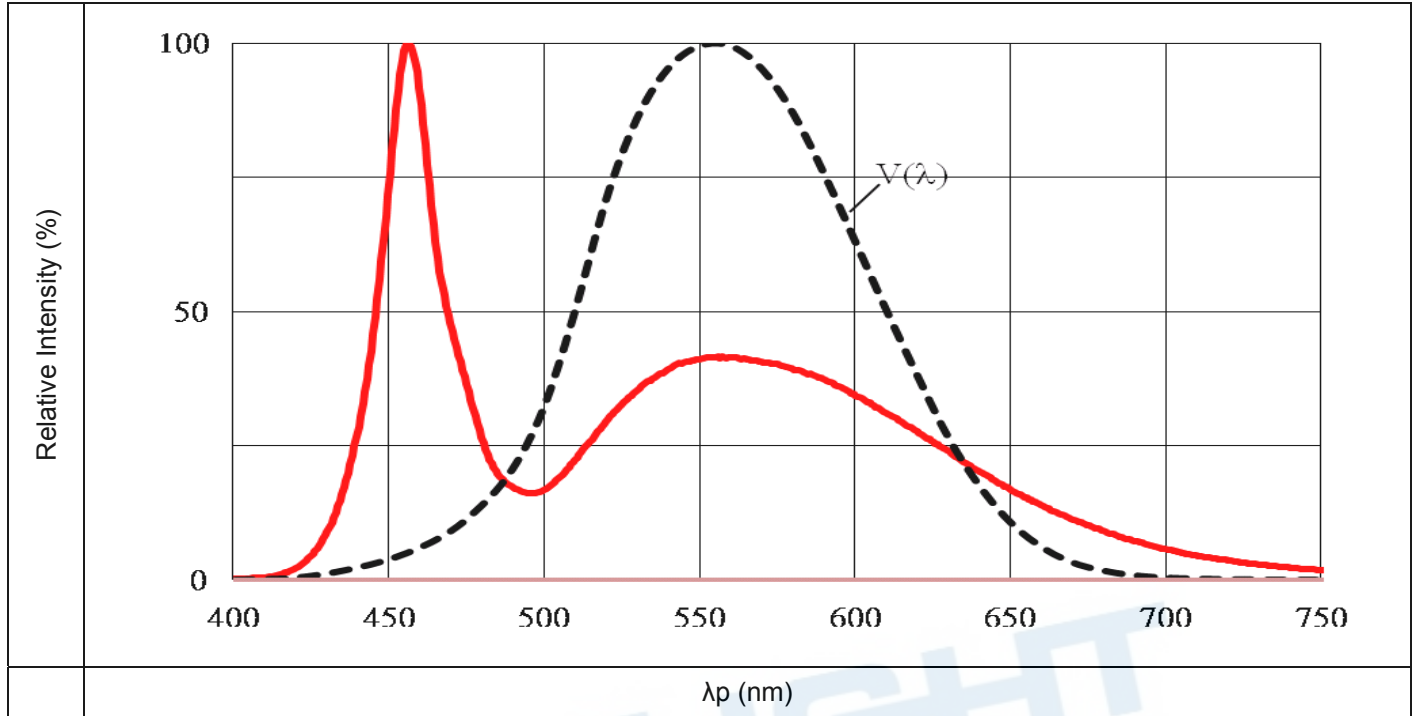

Note: $V(\lambda)$ =Standard eye response curve; $I_F = 150\text{mA}$

Diagram Characteristics of Radiation

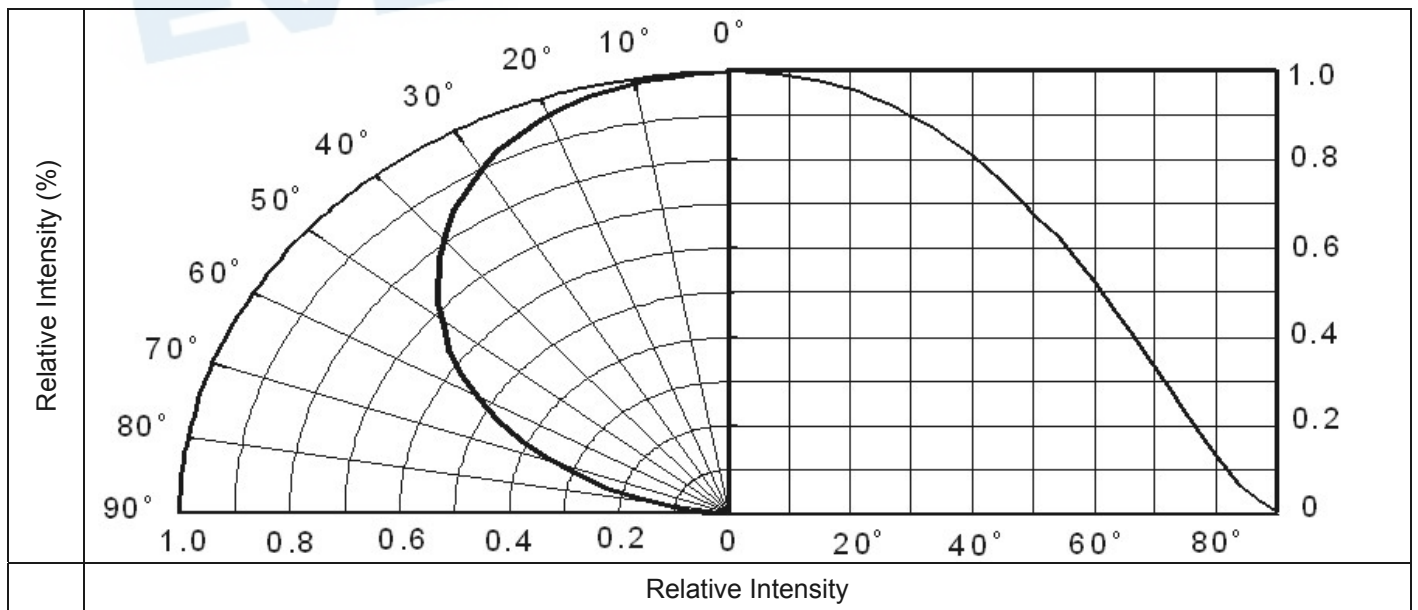

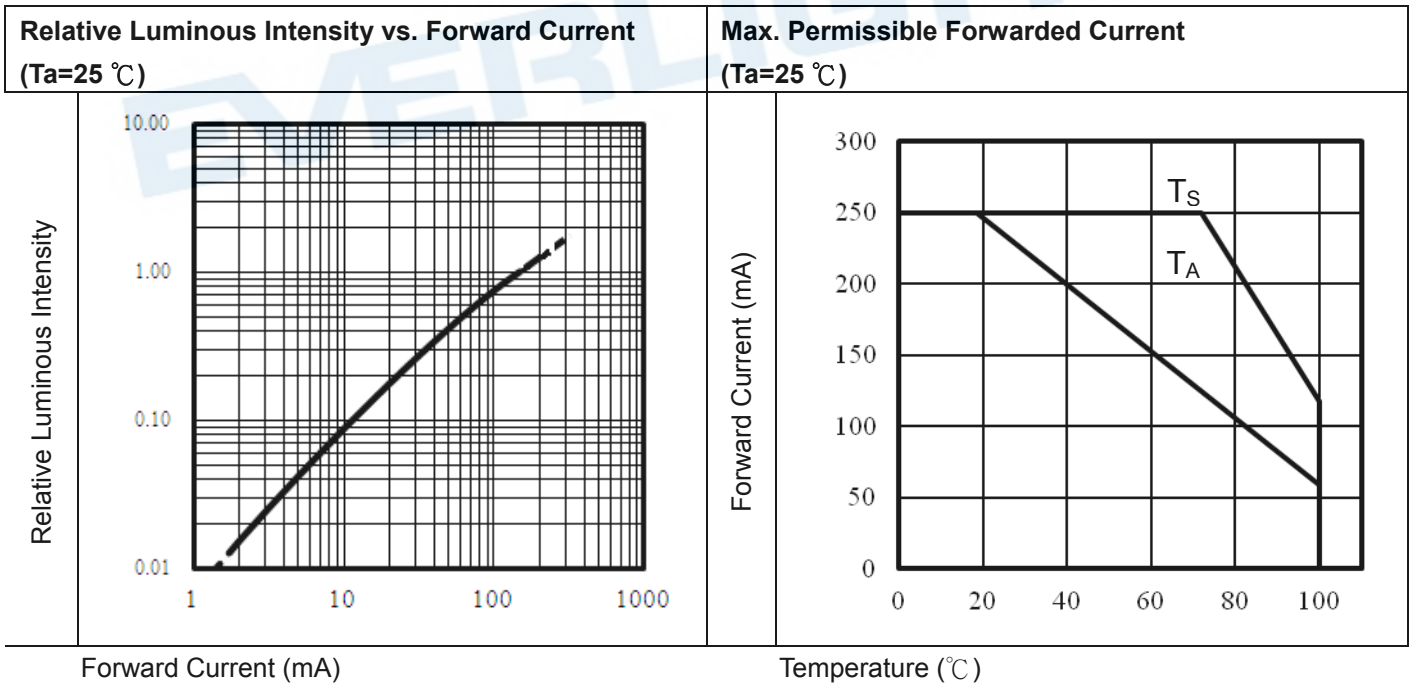
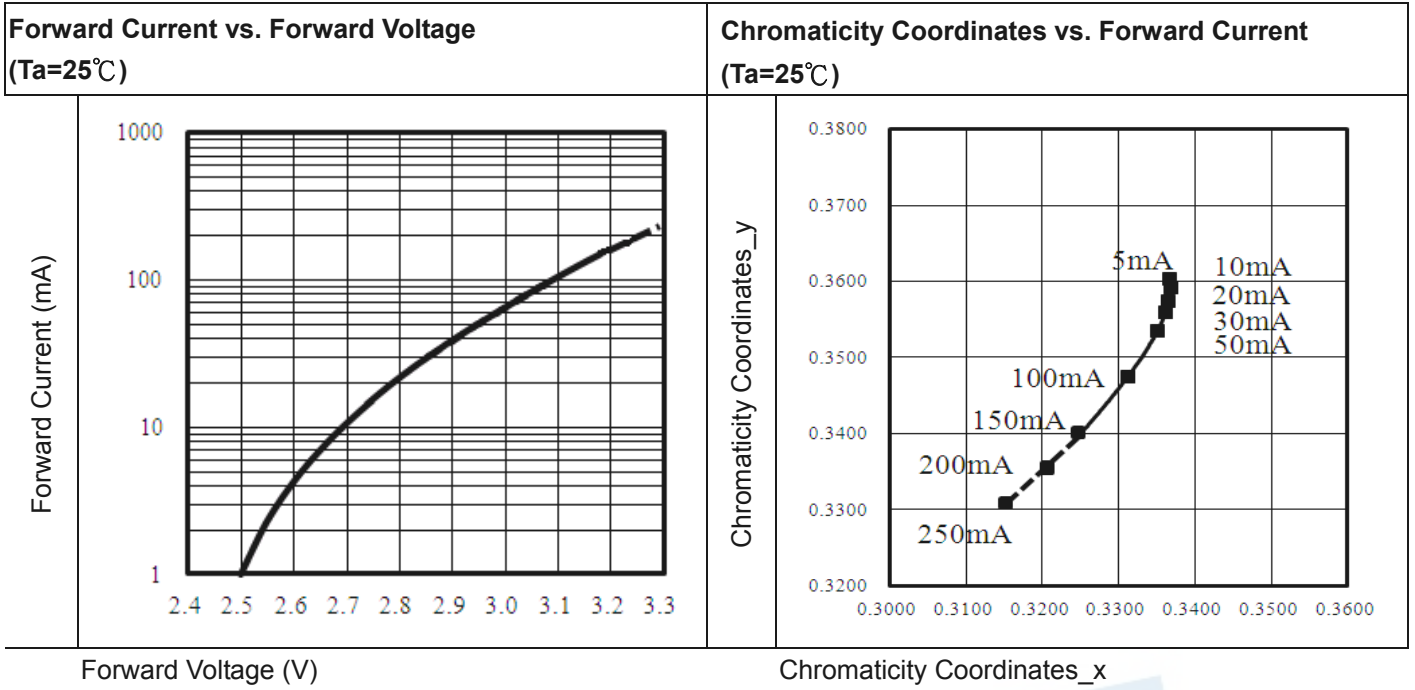

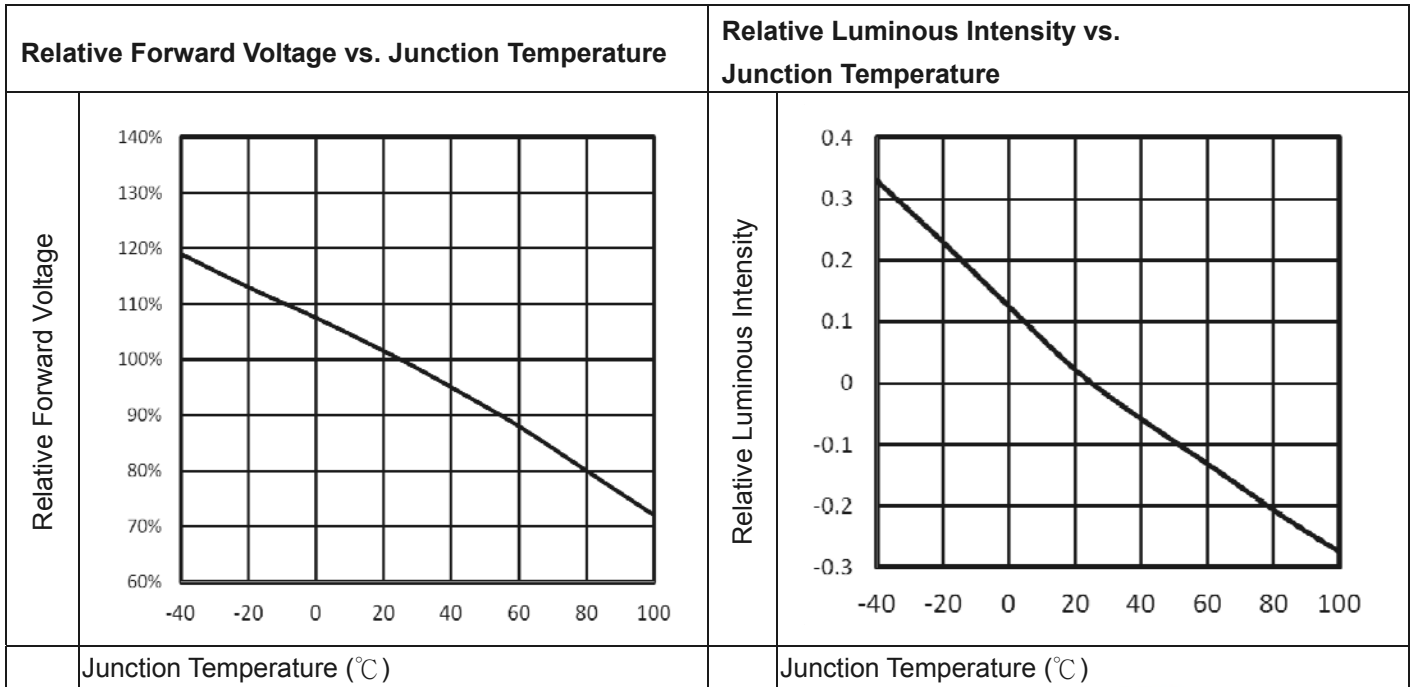

Note: $\Delta V_F = V_F - V_F(25^\circ\text{C}) = f(T_j)$; $I_F = 150\text{mA}$

Note: $f(T_j) = I_v / I_v(25^\circ\text{C})$; $I_F = 150\text{mA}$



Package Dimension

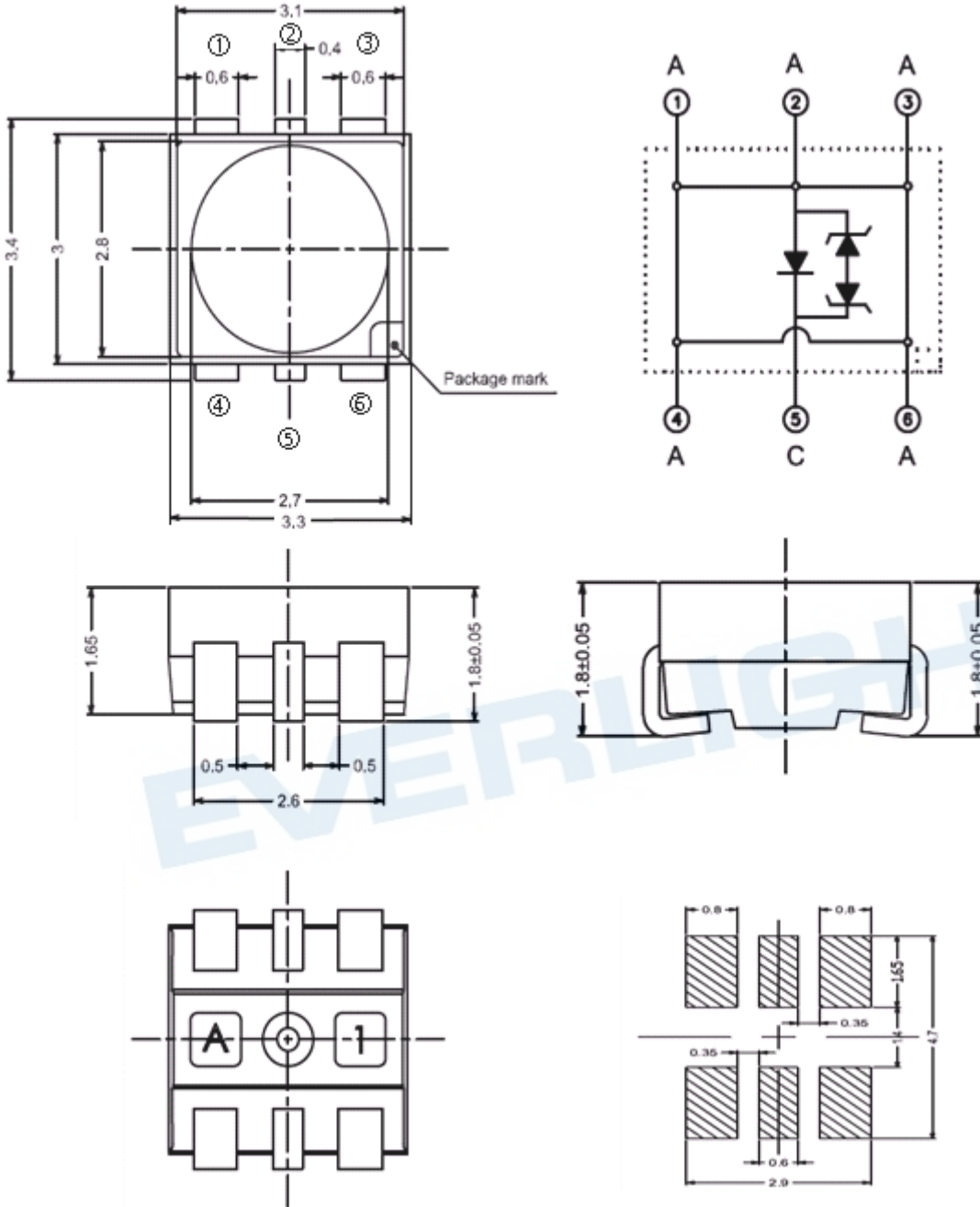

Note: Tolerances unless mentioned ±0.1mm. Unit = mm

Moisture Resistant Packing Materials

Label Explanation



- CPN: Customer's Product Number
- P/N: Product Number
- QTY: Packing Quantity
- CAT: Luminous Intensity Rank
- HUE: Dom. Wavelength Rank
- REF: Forward Voltage Rank
- LOT No: Lot Number

Reel Dimensions

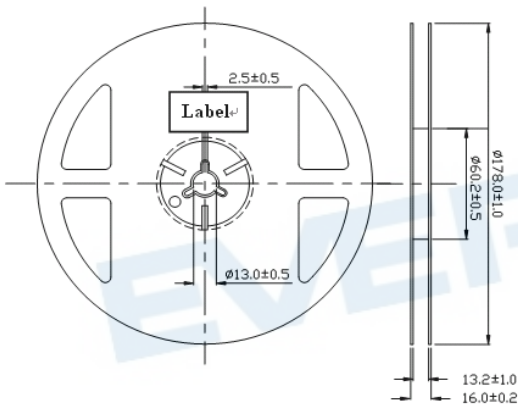

Carrier Tape Dimensions: Loaded Quantity 1000 pcs Per Reel

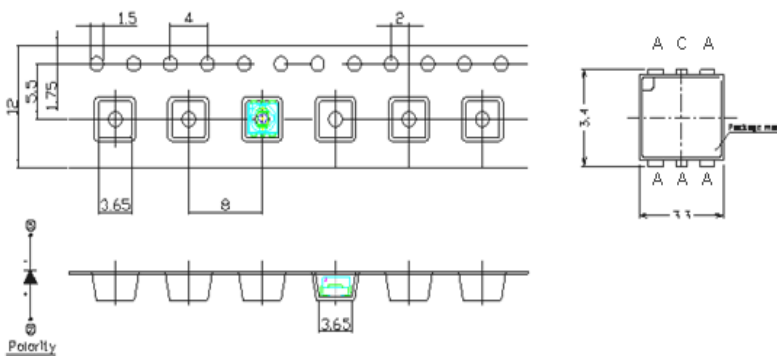

Note: Tolerances unless mentioned ± 0.1 mm. Unit = mm

Moisture Resistant Packing Process

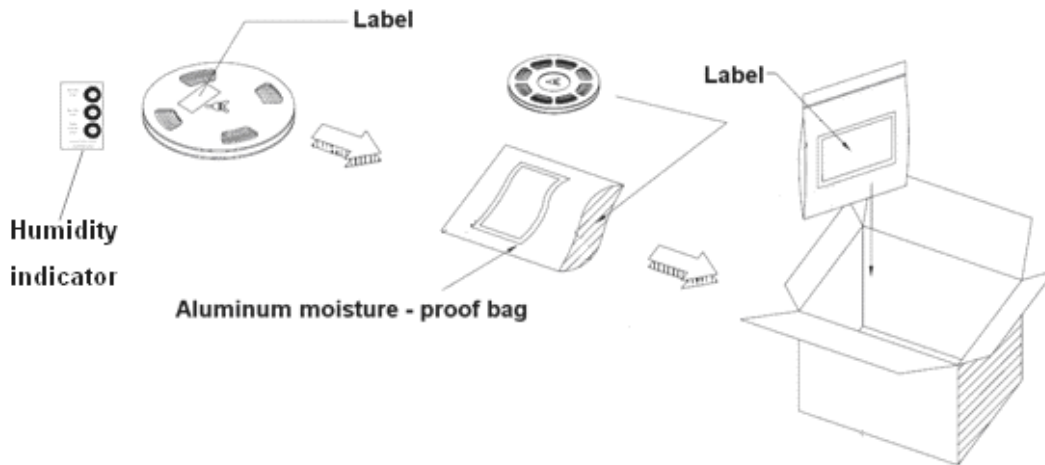

Note: Tolerances unless mentioned $\pm 0.1\text{mm}$. Unit = mm

Precautions for Use

1. Soldering Condition (Reference: IPC/JEDEC J-STD-020D)

IR Reflow

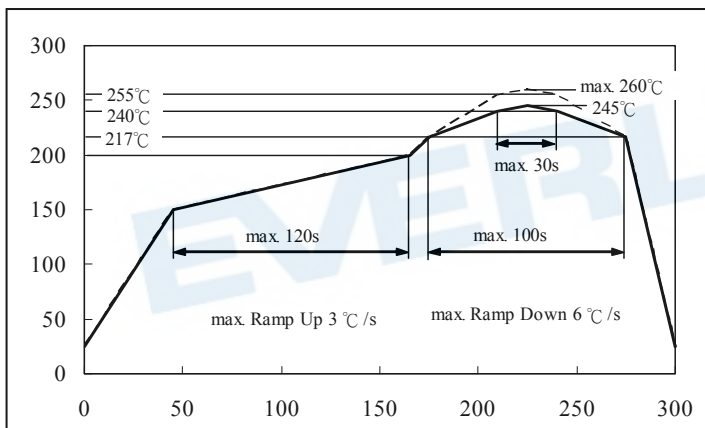

2. Current Limiting

Though A09K has conducted ESD protection mechanism, customers must not use the device in reverse and should apply resistors for extra protection. Otherwise, slight voltage difference may cause enormous current shift and burn out failure would happen.

3. Storage

- 3.1 Moisture proof bag should only be opened immediately prior to usage.
- 3.2 Environment should be less than 30 °C and 60 % RH when moisture proof bag is opened.
- 3.3 If the moisture sensitivity card indicates higher than acceptable moisture, the component should be baked at min. 60 deg +/-5 deg for 24 hours.

4. Thermal Management

4.1 For maintaining the high flux output and achieving reliability, A09K series LEDs should be mounted on a metal core printed circuit board (MCPCB) or other kinds of heat sink with proper thermal connection to dissipate approximate 0.5 W of thermal energy at 150 mA operation.

4.2 Sufficient thermal management must be implemented. Otherwise, the junction temperature of dies might be over the limit at high current driving condition and LEDs' lifetime might be decreases dramatically.

5. Iron Soldering

Hand soldering is not recommended for regular production. These guidelines are for rework only. Soldering iron tip should contact each terminal no more than 3 sec at 350 °C, using soldering iron with nominal power less than 25 W. Allow min. 2 sec. between soldering intervals.

6. Usage

Do not exceed the values given in this specification.

EVERLIGHT