

# 深圳华芯鸿电子有限公司

## 产品规格书

### PRODUCT SPECIFICATION SHEET

物料名称 (APPELLATION): 4Gb DDR3L SDRAM

产品型号 (MODEL): HG-DR30232-620001

客户料号 (No.): \_\_\_\_\_

生产方	工艺审核 TECHNICAL	品质审核 QUALITY	项目审核 PROJECT	开发审核 DEVELOPING

客户方	零件工程师 Cecomponent Engineer	设计工程师 Engineer	主管审批 Approval	研发体系 R & D System

地址: 深圳市光明新区华强创意园 3A804  
深圳市南山区西丽牛成 221 大厦 5 楼

电话: 0755-27652977

传真: 0755-27652992

Mr.Lee: 15013501940 & Ms.wang: 13923779042

E-mail: [lpzhxh@163.com](mailto:lpzhxh@163.com) , [wcxhxx@163.com](mailto:wcxhxx@163.com)



# Hosin Global 4G bits DDR3L SDRAM Datasheet

Version 1.0



## Release Note

Version	Date	Description	Notes
1.0	2020/1/10	First Release	-

CONFIDENTIAL

### Description

DDR3L SDRAM (1.35V) is a low voltage version of the DDR3 (1.5V) SDRAM. Refer to the DDR3 (1.5V) SDRAM data sheet specifications when running in 1.5V compatible mode.

### Features

- VDD = VDDQ = 1.35V (1.283–1.45V)



- Backward compatible to  $VDD = VDDQ = 1.5V \pm 0.075V$
- Supports DDR3L devices to be backward compatible in 1.5V applications
- Differential bidirectional data strobe
- 8n-bit prefetch architecture
- Differential clock inputs (CK, CKB)
- 8 internal banks
- Nominal and dynamic on-die termination (ODT) for data, strobe, and mask signals
- Programmable CAS (READ) latency (CL)
- Programmable posted CAS additive latency (AL)
- Programmable CAS (WRITE) latency (CWL)
- Fixed burst length (BL) of 8 and burst chop (BC) of 4 (via the mode register set [MRS])
- Selectable BC4 or BL8 on-the-fly (OTF)
- Self-refresh mode
- TC of 0°C to + 95°C
  - 64ms, 8192-cycle refresh at 0°C to +85°C
  - 32ms at +85°C to +95°C
- Self-refresh temperature (SRT)
- Automatic self-refresh (ASR)
- Write leveling
- Multi-purpose register
- Output driver calibration



## Options

- Configuration
  - 512 Meg x 8
  - 256 Meg x 16
- FBGA package (Pb-free) – x8
  - 78-ball (10.6mm x 7.5mm)
- FBGA package (Pb-free) – x16
  - 96-ball (13.5mm x 7.5mm)
- Timing – cycle time
  - 938ps @ CL = 14 (DDR3-2133)
  - 1.07ns @ CL = 13 (DDR3-1866)
  - 1.25ns @ CL = 11 (DDR3-1600)
- Operating temperature
  - Commercial (0°C ≤ TC ≤ +95°C)

## Key Timing Parameters

Speed Grade	Data Rate (MT/s)	Target tRCD-tRP-CL	tRCD (ns)	tRP (ns)	CL (ns)
-093 <sup>1, 2</sup>	2133	14-14-14	13.09	13.09	13.09
-107 <sup>1</sup>	1866	13-13-13	13.91	13.91	13.91
-125	1600	11-11-11	13.75	13.75	13.75

- Notes: 1 Backward compatible to 1600, CL = 11 (-125).  
 2 Backward compatible to 1866, CL = 13 (-107).

## Addressing

Parameter	512 Meg x 8	256 Meg x 16
Configuration	64 Meg x 8 x 8 banks	32 Meg x 16 x 8 banks
Refresh count	8K	8K
Row address	64K (A[15:0])	32K (A[15:0])
Bank address	8 (BA[2:0])	8 (BA[2:0])
Column address	1K (A[9:0])	1K (A[9:0])
Page size	1KB	2KB

## DDR3L Part Numbers



**HG - DR 3 02 3 2 - 6 2 0 0 0 1**

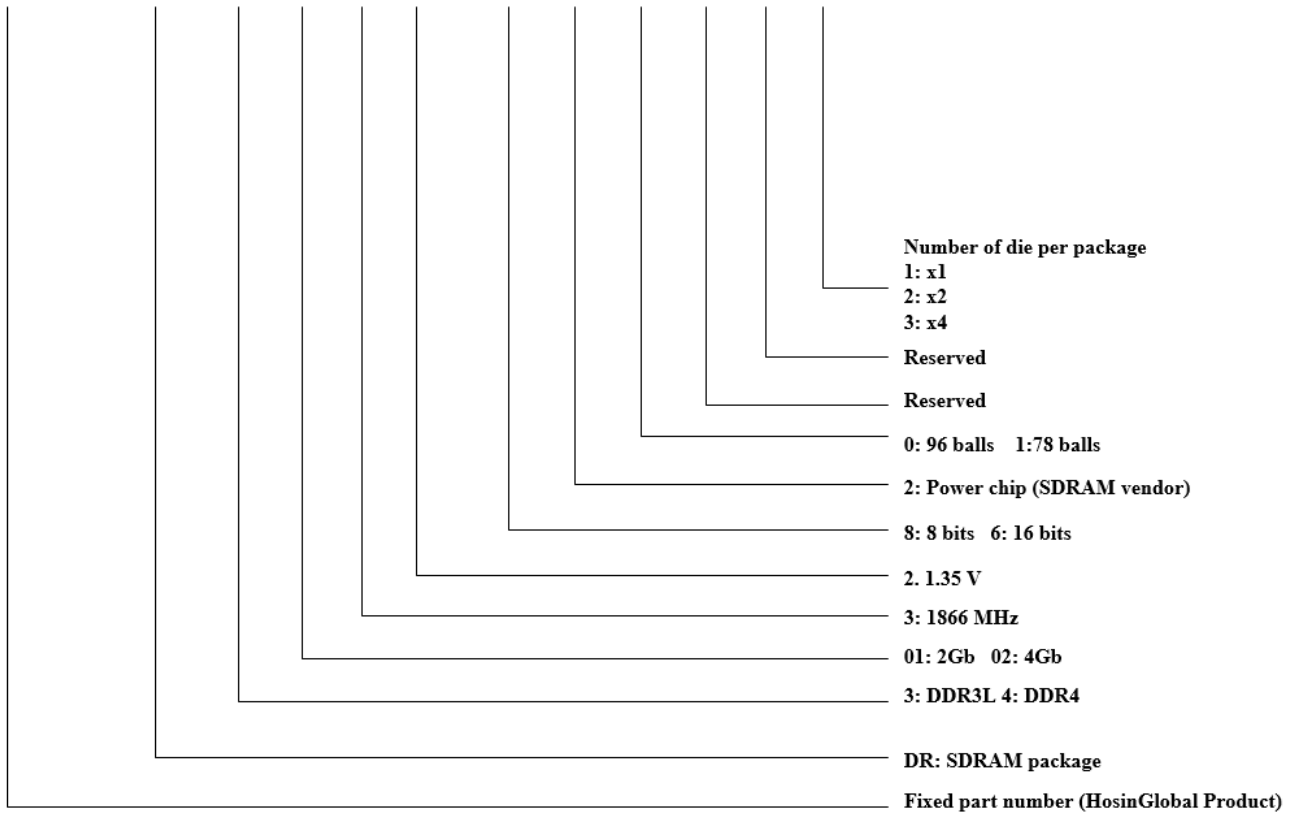

CONFIDENTIAL



## Table of Contents

<b>1.</b>	<b>State Diagram</b> .....	<b>8</b>
1.1	Simplified State Diagram .....	8
<b>2.</b>	<b>Functional Description</b> .....	<b>9</b>
2.1	Industrial Temperature .....	10
2.2	General Notes .....	10
<b>3.</b>	<b>Functional Block Diagrams</b> .....	<b>11</b>
<b>4.</b>	<b>Ball Assignments and Package Dimensions</b> .....	<b>13</b>
4.1	Ball Assignments .....	13
4.2	Package Dimensions .....	19
<b>5.</b>	<b>Electrical and Thermal Specifications</b> .....	<b>21</b>
5.1	Absolute Ratings .....	21
5.2	Thermal Characteristics .....	23
5.3	Electrical Specifications – IDD Specifications and Conditions .....	24
5.4	Electrical Characteristics – Operating IDD Specifications .....	34
5.5	Electrical Specifications – DC and AC .....	35
<b>6.</b>	<b>ODT Characteristics</b> .....	<b>46</b>
<b>7.</b>	<b>Output Driver Impedance</b> .....	<b>52</b>
<b>8.</b>	<b>Output Characteristics and Operating Conditions</b> .....	<b>58</b>
<b>9.</b>	<b>Speed Bin Tables</b> .....	<b>64</b>
<b>10.</b>	<b>Electrical Characteristics and AC Operating Conditions</b> .....	<b>67</b>
<b>11.</b>	<b>Setup, Hold, and Derating</b> .....	<b>86</b>
11.1	Command and Address Setup, Hold, and Derating .....	86
11.2	Data Setup, Hold, and Derating .....	93
<b>12.</b>	<b>Commands – Truth Tables</b> .....	<b>100</b>
<b>13.</b>	<b>Input Clock Frequency Change</b> .....	<b>111</b>
<b>14.</b>	<b>Write Leveling</b> .....	<b>113</b>
14.1	Write Leveling Procedure .....	116
14.2	Write Leveling Sequence .....	117
14.3	Write Leveling Mode Exit Procedure .....	118
<b>15.</b>	<b>Initialization</b> .....	<b>119</b>
15.1	Power-Up Initialization .....	119
15.2	Voltage Initialization / Change.....	121
15.3	VDD Voltage Switching .....	122
15.4	Mode Registers .....	123
<b>16.</b>	<b>Operation</b> .....	<b>144</b>





16.1 ZQ CALIBRATION Operation .....	144
16.2 ACTIVATE Operation .....	145
16.3 READ Operation .....	146
16.4 WRITE Operation .....	157
16.5 PRECHARGE Operation .....	165
16.6 SELF REFRESH Operation .....	165
16.7 Extended Temperature Usage .....	167
16.8 Power-Down Mode .....	169
16.9 RESET Operation .....	178
<b>17. On-Die Termination (ODT).....</b>	<b>180</b>
17.1 Dynamic ODT .....	182
17.2 Synchronous ODT Mode .....	189
17.3 Asynchronous ODT Mode .....	192
17.4 Asynchronous to Synchronous ODT Mode Transition (Power-Down Exit) .....	195



# 1. State Diagram

## 1.1 Simplified State Diagram

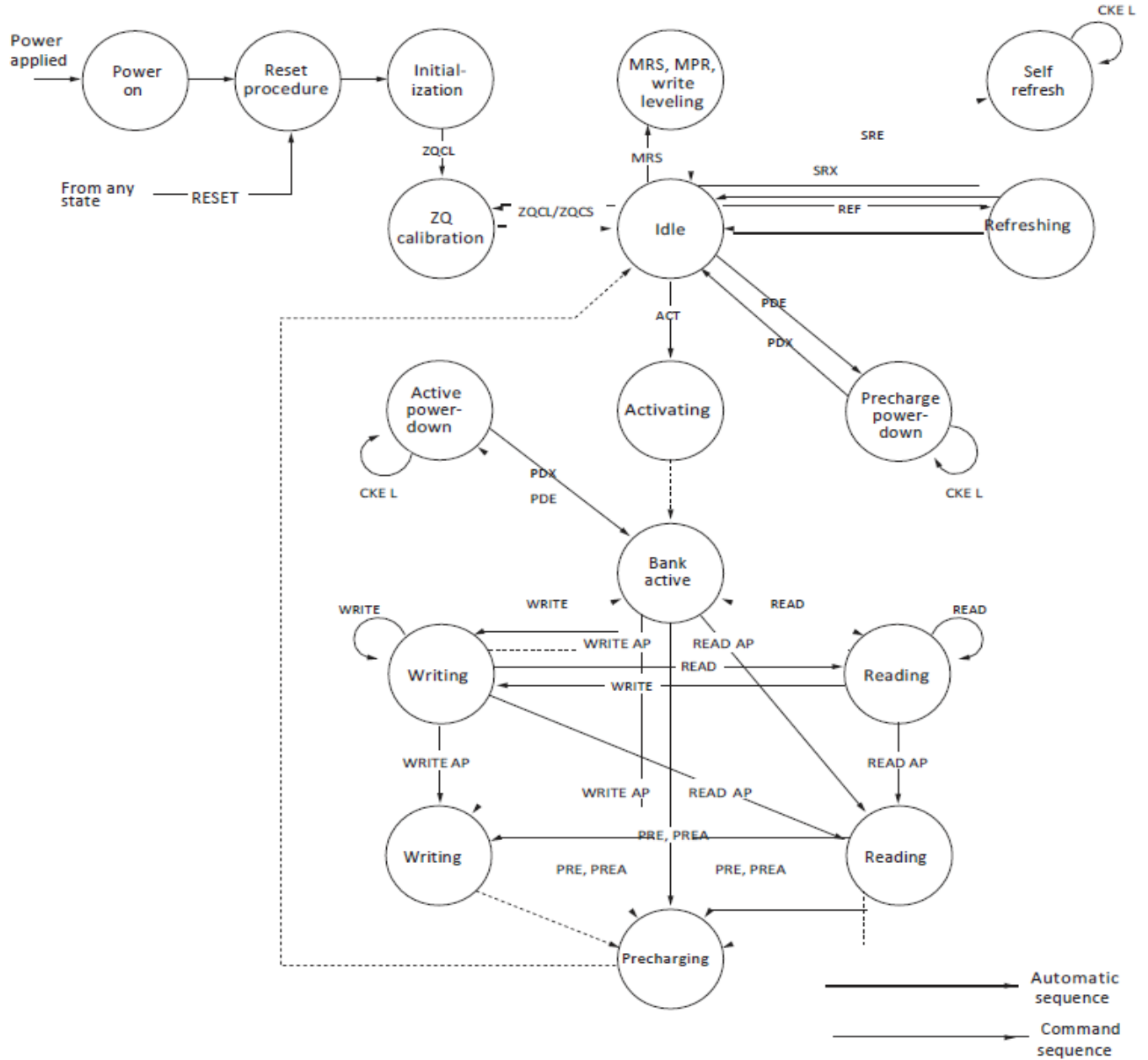

ACT = ACTIVATE  
MPR = Multipurpose register  
MRS = Mode register set

PDE = Power-down entry  
PDX = Power-down exit  
PRE = PRECHARGE

PREA = PRECHARGE ALL  
READ = RD, RDS4, RDS8  
READ AP = RDAP, RDAPS4, RDAPS8

REF = REFRESH  
RESET = START RESET PROCEDURE  
SRE = Self refresh entry

SRX = Self refresh exit  
WRITE = WR, WRS4, WRS8  
WRITE AP = WRAP, WRAPS4, WRAPS8  
ZQCL = ZQ LONG CALIBRATION  
ZQCS = ZQ SHORT CALIBRATION

————— Automatic sequence  
- - - - - Command sequence



## 2. Functional Description

DDR3 SDRAM uses double data rate architecture to achieve high-speed operation. The double data rate architecture is an  $8n$ -prefetch architecture with an interface designed to transfer two data words per clock cycle at the I/O pins. A single read or write operation for the DDR3 SDRAM effectively consists of a single  $8n$ -bit-wide, four-clock-cycle data transfer at the internal DRAM core and eight corresponding  $n$ -bit-wide, one-half-clock-cycle data transfers at the I/O pins.

The differential data strobe (DQS, DQS#) is transmitted externally, along with data, for use in data capture at the DDR3 SDRAM input receiver. DQS is center-aligned with data for WRITES. The read data is transmitted by the DDR3 SDRAM and edge-aligned to the data strobes.

The DDR3 SDRAM operates from a differential clock (CK and CKB). The crossing of CK going HIGH and CKB going LOW is referred to as the positive edge of CK. Control, command, and address signals are registered at every positive edge of CK. Input data is registered on the first rising edge of DQS after the WRITE preamble, and output data is referenced on the first rising edge of DQS after the READ preamble.

Read and write accesses to the DDR3 SDRAM are burst-oriented. Access start at a selected location and continue for a programmed number of locations in a programmed sequence. Accesses begin with the registration of an ACTIVATE command, which is then followed by a READ or WRITE command. The address bits registered coincident with the ACTIVATE command are used to select the bank and row to be accessed. The address bits registered coincident with the READ or WRITE commands are used to select the bank and the starting column location for the burst access.

The device uses a READ and WRITE BL8 and BC4. An auto precharge function maybe enabled to provide a self-timed row precharge that is initiated at the end of the burst access.

As with standard DDR SDRAM, the pipelined, multibank architecture of DDR3 SDRAM allows for concurrent operation, thereby providing high bandwidth by hiding row pre-charge and activation time.

A self-refresh mode is provided, along with a power-saving, power-down mode.



## 2.1 Industrial Temperature

The industrial temperature (IT) device requires that the case temperature not exceed

-40°C or 95°C. JEDEC specifications require the refresh rate to double when  $T_c$  exceeds 85°C; this also requires use of the high-temperature self refresh option.

Additionally, ODT resistance and the input/output impedance must be derated when  $T_c$  is  $< 0^\circ\text{C}$  or  $> 95^\circ\text{C}$ .

## 2.2 General Notes

- The functionality and the timing specifications discussed in this data sheet are for the DLL enable mode of operation (normal operation).
- Through out this datasheet, various figures and text refer to DQs as “DQ.” DQ is to be interpreted as any and all DQ collectively, unless specifically stated otherwise.
- The terms “DQS” and “CK” found through out this datasheet are to be interpreted as DQS, DQS# and CK, CKB respectively, unless specifically stated otherwise.
- Complete functionality may be described throughout the document; any page or diagram may have been simplified to convey a topic and may not be inclusive of all requirements.
- Any specific requirement takes precedence over a general statement.
- Any functionality not specifically stated is considered undefined, illegal, and not supported, and can result in unknown operation.
- Row addressing is denoted as A[n:0]. For example, 1Gb: n= 12 (x16); 1Gb: n= 13 (x4, x8); 2Gb:n =13(x16) and 2Gb:n =14(x4,x8);4Gb:n = 14(x16);and4Gb:n =15(x4, x8).
- Dynamic ODT has a special use case: when DDR3 devices are architected for use in a single rank memory array, the ODT ball can be wired HIGH rather than routed. Refer to the Dynamic ODT Special Use Case section.
- Ax16 device's DQ bus is comprised of two bytes. If only one of the bytes needs to be used, use the lower byte for data transfers and terminate the upper byte as noted:
  - Connect UDQS to ground via 1kΩ\* resistor.
  - Connect UDQS# to  $V_{DD}$  via 1kΩ\* resistor.
  - Connect UDM to  $V_{DD}$  via 1kΩ\* resistor.
  - Connect DQ[15:8] individually to either VSS, VDD, or VREF via 1kΩ resistors,\* or float DQ[15:8].

\*If ODT is used, 1kΩ resistor should be changed to 4x that of the selected ODT



### 3. Functional Block Diagrams

DDR3 SDRAM is a high-speed, CMOS dynamic random access memory. It is internally configured as an 8-bank DRAM.

512 Meg x 8 Functional Block Diagram

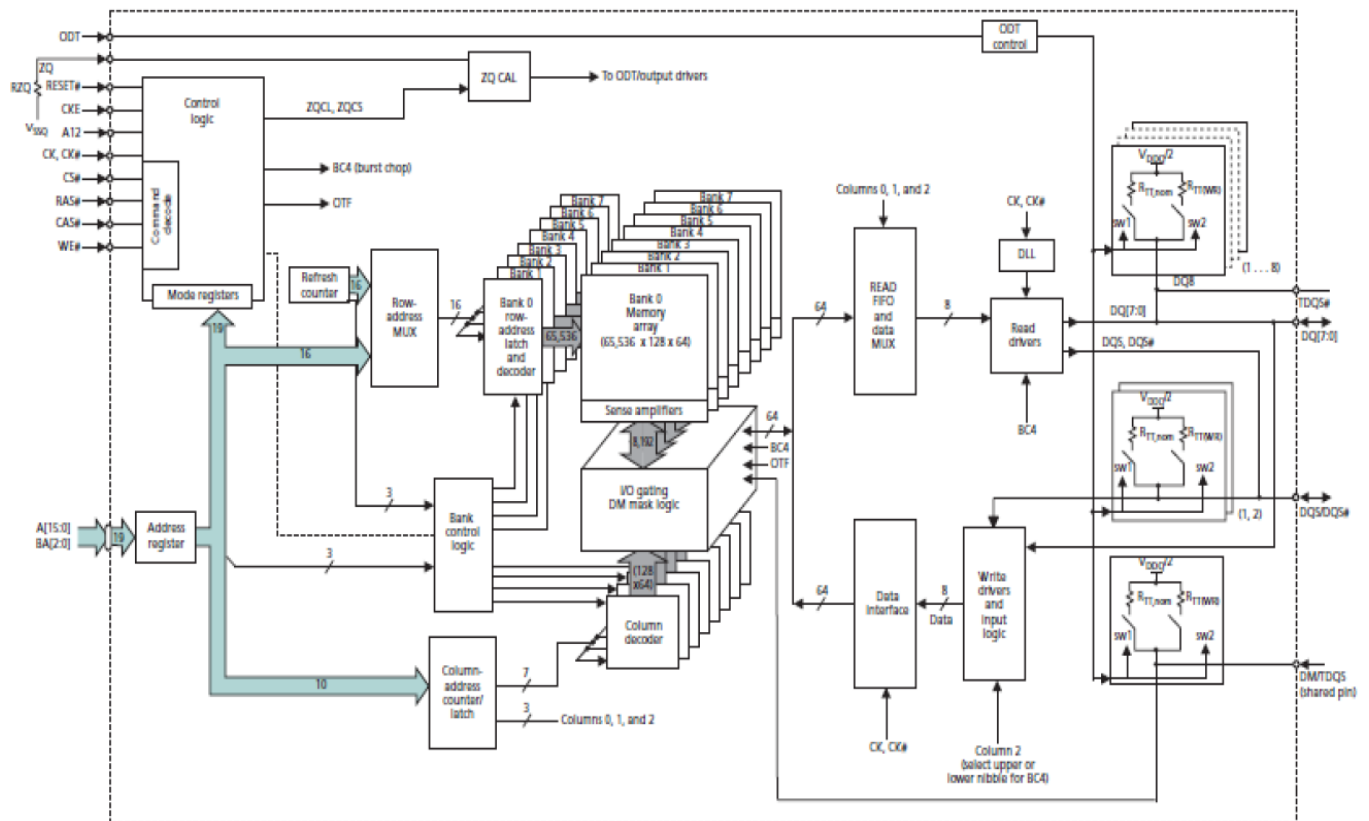

256 Meg x 16 Functional Block Diagram



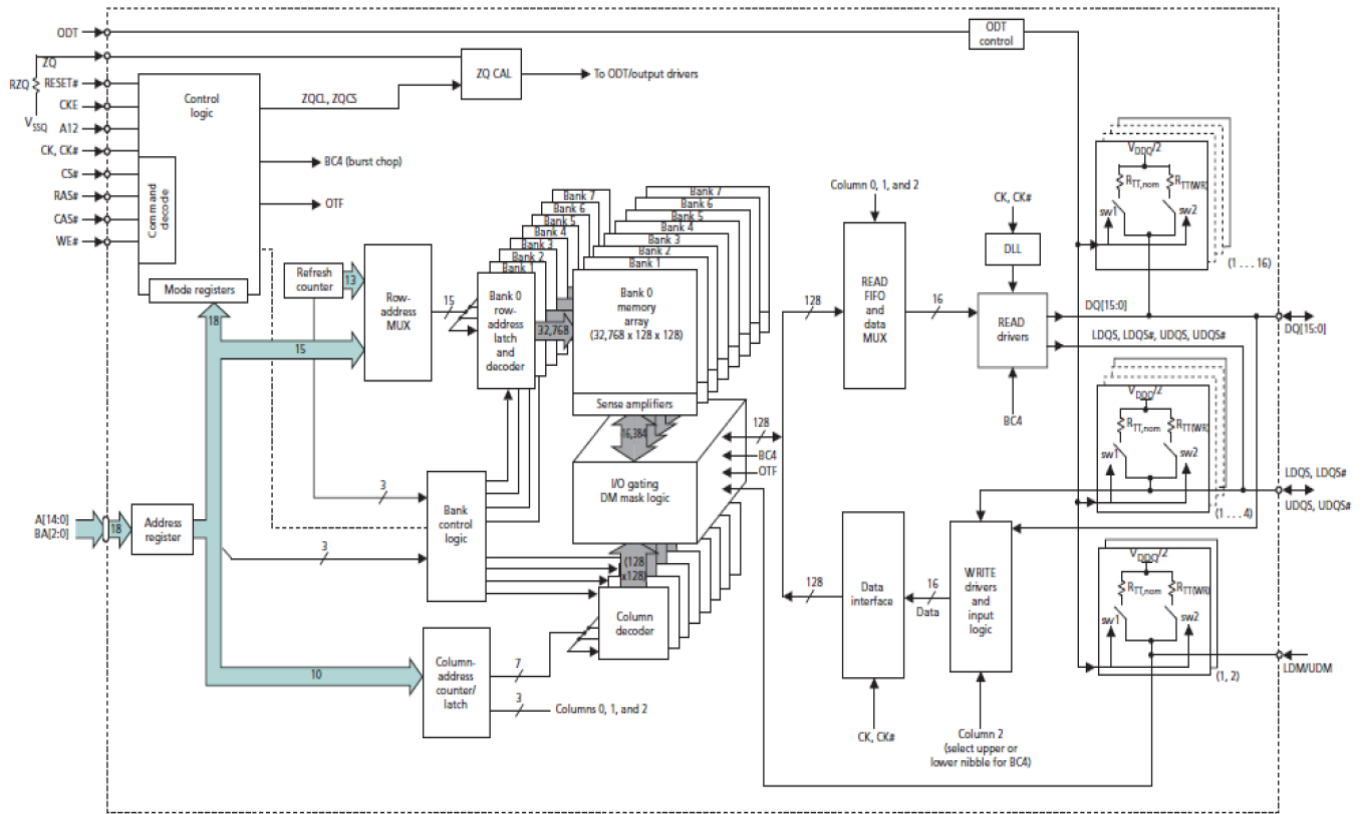

CONFIDENTIAL



## 4. Ball Assignments and Package Dimensions

### 4.1 Ball Assignments

78-Ball FBGA – x8 (Top View)

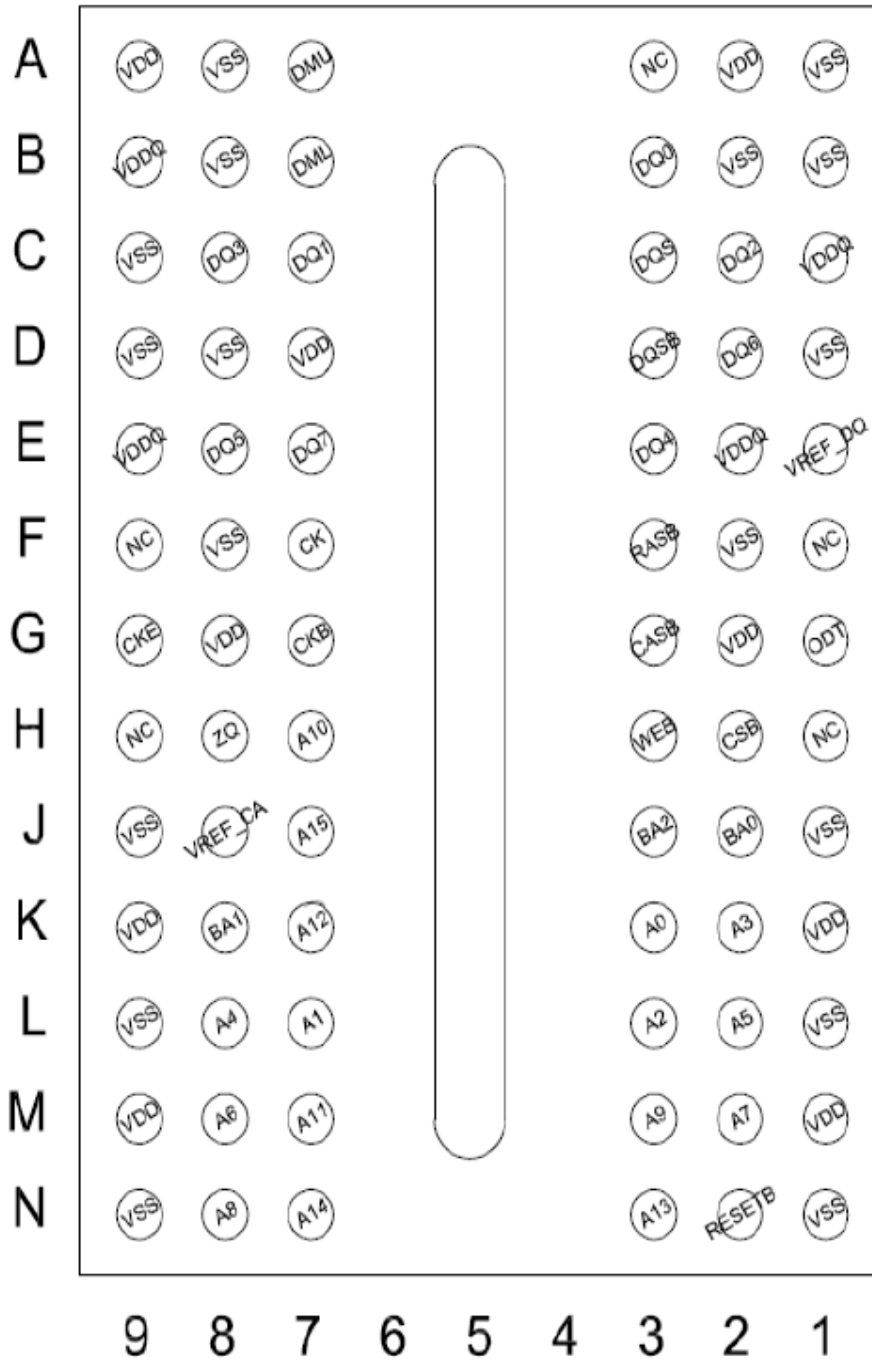

96-Ball FBGA – x16 (Top View)

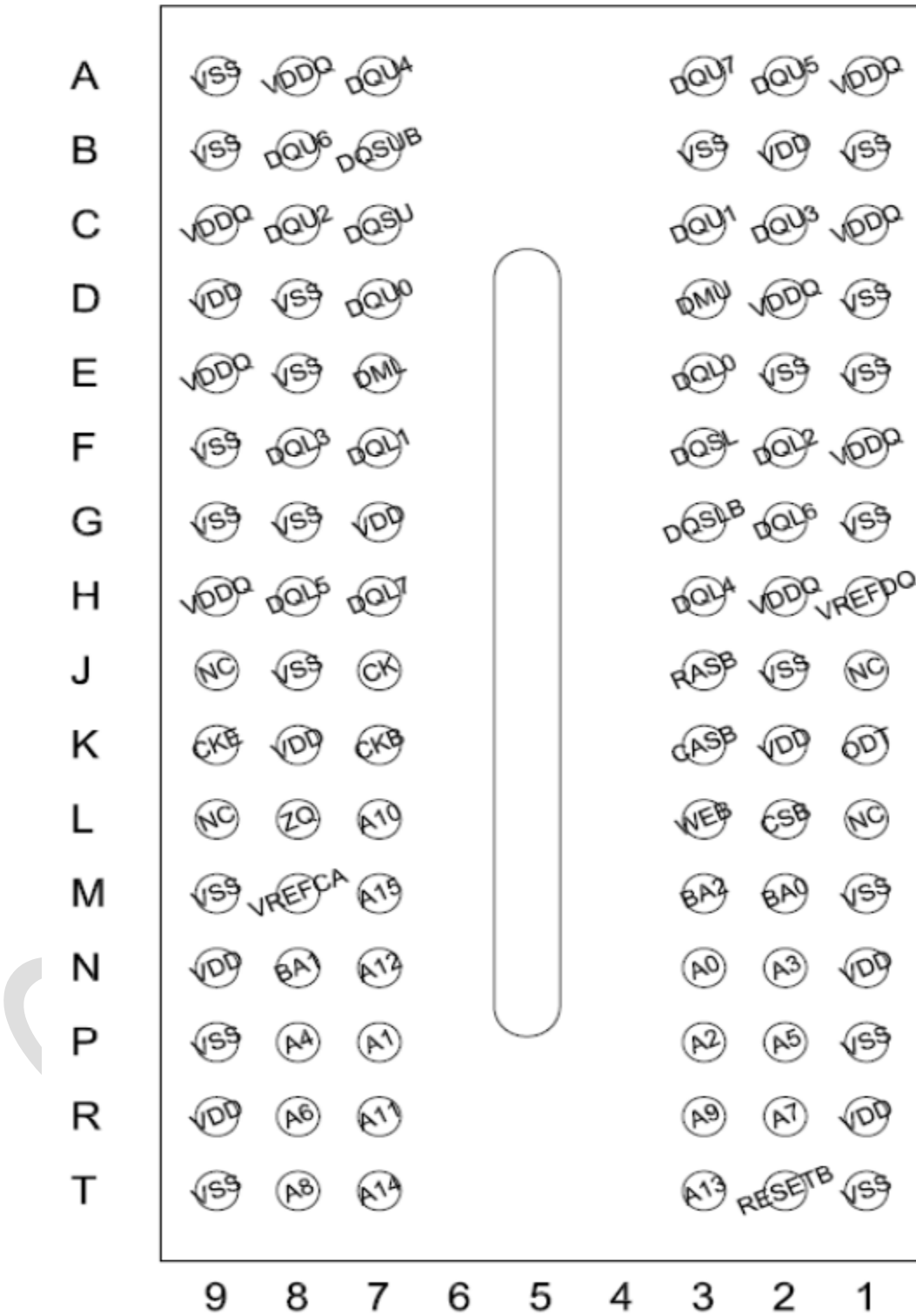



### 78-Ball FBGA – x8 Ball Descriptions

Symbol	Type	Description
A[15:13], A12, A11, A10/AP, A[9:0]	Input	<b>Address inputs:</b> Provide the row address for ACTIVATE commands, and the column address and auto precharge bit (A10) for READ/WRITE commands, to select one location out of the memory array in the respective bank. A10 sampled during a PRECHARGE command determines whether the PRECHARGE applies to one bank (A10LOW, bank selected by BA[2:0]) or all banks (A10HIGH). The address inputs also provide the opcode during a LOADMODE command. Address inputs are referenced to VREFCA. A12 is sampled during READ and WRITE commands to determine whether burst chop (on-the-fly) will be performed (HIGH = BL8 or no burst chop, LOW = BC4).
BA[2:0]	Input	<b>Bank address inputs:</b> BA[2:0] define the bank to which an ACTIVATE, READ, WRITE, or PRECHARGE command is being applied. BA[2:0] define which mode register (MR0, MR1, MR2, or MR3) is loaded during the LOAD MODE command. BA[2:0] are referenced to VREFCA.
CK, CK#	Input	<b>Clock:</b> CK and CK# are differential clock inputs. All control and address input signals are sampled on the crossing of the positive edge of CK and the negative edge of CK#. Output data strobe (DQS, DQS#) is referenced to the crossings of CK and CK#.
CKE	Input	<b>Clock enable:</b> CKE enables (registered HIGH) and disables (registered LOW) internal circuitry and clocks on the DRAM. The specific circuitry that is enabled/disabled is dependent upon the DDR3 SDRAM configuration and operating mode. Taking CKE LOW provides PRECHARGE POWER-DOWN and SELF REFRESH operations (all banks idle), or active power-down (row active in any bank). CKE is synchronous for power-down entry and exit and for self refresh entry. CKE is asynchronous for self refresh exit. Input buffers (excluding CK, CK#, CKE, RESET#, and ODT) are disabled during POWER-DOWN. Input buffers (excluding CKE and RESET#) are disabled during SELF REFRESH. CKE is referenced to VREFCA.
CS#	Input	<b>Chip select:</b> CS# enables (registered LOW) and disables (registered HIGH) the command decoder. All commands are masked when CS# is registered HIGH. CS# provides for external rank selection on systems with multiple ranks. CS# is considered part of the command code. CS# is referenced to VREFCA.
DM	Input	<b>Input data mask:</b> DM is an input mask signal for write data. Input data is masked when DM is sampled HIGH along with the input data during a write access. Although the DM ball is input-only, the DM loading is designed to match that of the DQ and DQS balls. DM is referenced to VREFDQ. DM has an optional use.
ODT	Input	<b>On-die termination:</b> ODT enables (registered HIGH) and disables (registered LOW) termination resistance internal to the DDR3 SDRAM. When enabled in normal operation, ODT is only applied to each of the following balls: DQ[7:0], DQS, DQS#, and DM for the x8; DQ[3:0], DQS, DQS#, and DM for the x4. The ODT input is ignored if disabled via the LOAD MODE command. ODT is referenced to VREFCA.
RAS#, CAS#,	Input	<b>Command inputs:</b> RAS#, CAS#, and WE# (along with CS#) define the command being entered and are referenced to VREFCA.



WE#		
RESET#	Input	<b>Reset:</b> RESET# is an active LOW CMOS input referenced to VSS. The RESET# input receiver is a CMOS input defined as a rail-to-rail signal with DC HIGH $\geq 0.8 \times VDD$ and DC LOW $\leq 0.2 \times VDDQ$ . RESET# assertion and desertion are asynchronous.

78-Ball FBGA –x8 Ball Descriptions (Continued)

Symbol	Type	Description
DQ[7:0]	I/O	<b>Data input/output:</b> Bidirectional data bus for the x8 configuration. DQ[7:0] are referenced to VREFDQ.
DQS, DQS#	I/O	<b>Data strobe:</b> Output with read data. Edge-aligned with read data. Input with write data. Center-aligned to write data.
VDD	Supply	<b>Power supply:</b> 1.5V $\pm 0.075V$ .
VDDQ	Supply	<b>DQ power supply:</b> 1.5V $\pm 0.075V$ . Isolated on the device for improved noise immunity.
VREFCA	Supply	<b>Reference voltage for control, command, and address:</b> VREFCA must be maintained at all times (including self-refresh) for proper device
VREFDQ	Supply	<b>Reference voltage for data:</b> VREFDQ must be maintained at all times (excluding self-refresh) for proper device operation.
VSS	Supply	Ground.
ZQ	Reference	<b>External reference ball for output drive calibration:</b> This ball is tied to an external 240 $\Omega$ resistor (RZQ), which is tied to VSSQ.
NC	-	<b>No connect:</b> These balls should be left unconnected (the ball has no connection to the DRAM or to other balls).



### 96-Ball FBGA –x16 Ball Descriptions

Symbol	Type	Description
A[15:13], A12, A11, A10, A[9:0]	Input	<b>Address inputs:</b> Provide the row address for ACTIVATE commands, and the column address and auto precharge bit (A10) for READ/WRITE commands, to select one location out of the memory array in the respective bank. A10 sampled during a PRECHARGE command determines whether the PRECHARGE applies to one bank (A10 LOW, bank selected by BA[2:0]) or all banks (A10 HIGH). The address inputs also provide the opcode during a LOAD MODE command. Address inputs are referenced to $V_{REFCA}$ . A12 is sampled during READ and WRITE commands to determine whether burst chop (on-the-fly) will be performed (HIGH = BL8 or no burst chop, LOW = BC4).
BA[2:0]	Input	<b>Bank address inputs:</b> BA[2:0] define the bank to which an ACTIVATE, READ, WRITE, or PRECHARGE command is being applied. BA[2:0] define which mode register (MR0, MR1, MR2, or MR3) is loaded during the LOAD MODE command. BA[2:0] are referenced to $V_{REFCA}$ .
CK, CKB	Input	<b>Clock:</b> CK and CKB are differential clock inputs. All control and address input signals are sampled on the crossing of the positive edge of CK and the negative edge of CKB. Output data strobe (DQS, DQSB) is referenced to the crossings of CK and CKB.
CKE	Input	<b>Clock enable:</b> CKE enables (registered HIGH) and disables (registered LOW) internal circuitry and clocks on the DRAM. The specific circuitry that is enabled/ disabled is dependent upon the DDR3 SDRAM configuration and operating mode. Taking CKELow provides PRECHARGE POWER-DOWN and SELF REFRESH operations (all banks idle), or active power-down (row active in any bank). CKE is synchronous for power-down entry and exit and for self-refresh entry. CKE is asynchronous for self-refresh exit. Input buffers (excluding CK, CKB, CKE, RESETB, and ODT) are disabled during POWER-DOWN. Input buffers (excluding CKE and RESETB) are disabled during SELF REFRESH. CKE is referenced to $V_{REFCA}$ .
CSB	Input	<b>Chip select:</b> CSB enables (registered LOW) and disables (registered HIGH) the command decoder. All commands are masked when CSB is registered HIGH. CSB provides for external rank selection on systems with multiple ranks. CSB is considered part of the command code. CSB is referenced to $V_{REFCA}$ .
DML	Input	<b>Input data mask:</b> DML is a lower-byte, input mask signal for write data. Lower-byte input data is masked when DML is sampled HIGH along with the input data during a write access. Although the DML ball is input-only, the DML loading is designed to match that of the DQ and DQS balls. DML is referenced to $V_{REFDQ}$ .
ODT	Input	<b>On-die termination:</b> ODT enables (registered HIGH) and disables (registered LOW) Termination resistance internal to the DDR3 SDRAM. When enabled in normal operation, ODT is only applied to each of the following balls: DQL/DQU[7:0], DQSL, DQSLB, DQSU, DQSUB, DML, and DMU for the x16. The ODT input is ignored if disabled via the LOAD MODE command. ODT is referenced to $V_{REFCA}$ .
RASB, CASB, WEB	Input	<b>Command inputs:</b> RASB, CASB, and WEB (along with CSB) define the command being entered and are referenced to $V_{REFCA}$ .
RESETB	Input	<b>Reset:</b> RESETB is an active LOW CMOS input referenced to VSS. The RESETB input receiver is a CMOS input defined as a rail-to-rail signal with DC HIGH $\geq 0.8 \times VDD$ and DC LOW $\leq 0.2 \times VDDQ$ . RESETB assertion and desertion are asynchronous.



96-Ball FBGA –x16 Ball Descriptions (Continued)

Symbol	Type	Description
DMU	Input	<b>Input data mask:</b> DMU is an upper-byte, input mask signal for write data. Upper byte input data is masked when DMU is sampled HIGH along with that input data during a WRITE access. Although the DMU ball is input-only, the DMU loading is designed to match that of the DQ and DQS balls. DMU is referenced to VREFDQ.
DQL[7:0]	I/O	<b>Data input/output:</b> Bidirectional data bus for the x16 configuration. DQL[7:0] are reference to VREFDQ.
DQU[7:0]	I/O	<b>Data input/output:</b> Bidirectional data bus for the x16 configuration. DQU[7:0] are reference to VREFDQ.
DQSL, DQSLB	I/O	<b>Data strobe:</b> Output with read data. Edge-aligned with read data. Input with write data. Center-aligned to write data.
DQSU, DQSUB	I/O	<b>Data strobe:</b> Output with read data. Edge-aligned with read data. Input with write data. DQS is Center-aligned to write data.
V <sub>DD</sub>	Supply	<b>Power supply:</b> 1.5V ±0.075V.
V <sub>DDQ</sub>	Supply	<b>DQ power supply:</b> 1.5V ±0.075V. Isolated on the device for improved noise immunity.
VREFCA	Supply	<b>Reference voltage for control, command, and address:</b> VREFCA must be maintained at all times (including self-refresh) for proper device operation.
VREFDQ	Supply	<b>Reference voltage for data:</b> VREFDQ must be maintained at all times (excluding self-refresh) for proper device operation.
V <sub>SS</sub>	Supply	Ground.
ZQ	Reference	<b>External reference ball for output drive calibration:</b> This ball is tied to an external 240Ω resistor (RZQ), which is tied to V <sub>SSQ</sub> .
NC	-	<b>No connect:</b> These balls should be left unconnected (the ball has no connection to the DRAM or to other balls).





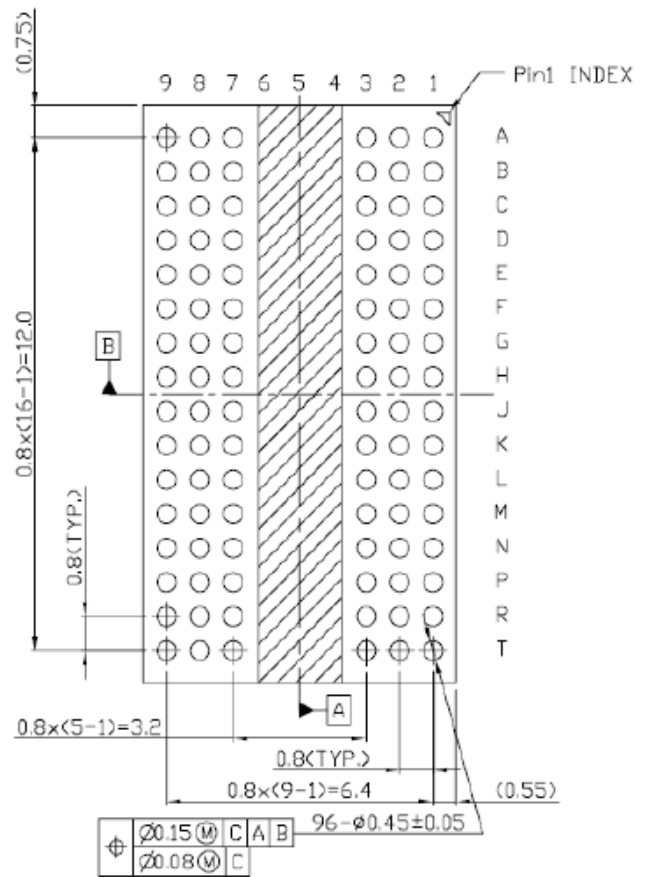
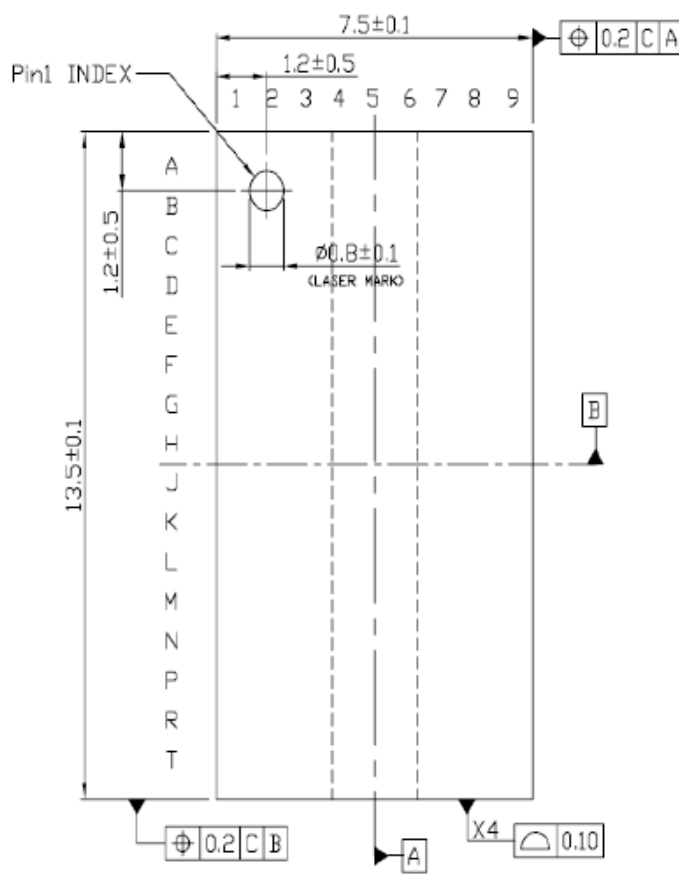
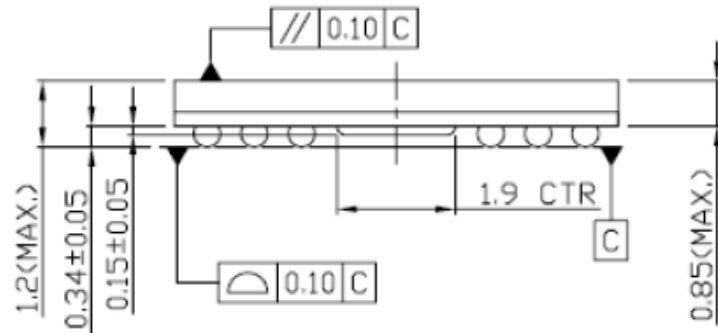

## 5. Electrical and Thermal Specifications

### 5.1 Absolute Ratings

Stresses greater than those listed may cause permanent damage to the device. This is a stress rating only, and functional operation of the device at these or any other conditions outside those indicated in the operational sections of this specification is not implied. Exposure to absolute maximum rating conditions for extended periods may adversely affect reliability.

#### Absolute Maximum Ratings

Symbol	Parameter	Min	Max	Unit	Notes
V <sub>DD</sub>	VDD supply voltage relative to VSS	-0.4	1.975	V	1
V <sub>DDQ</sub>	VDD supply voltage relative to VSSQ	-0.4	1.975	V	
V <sub>IN</sub> , V <sub>OUT</sub>	Voltage on any pin relative to VSS	-0.4	1.975	V	
TC	Operating case temperature – Commercial	0	95	°C	2, 3
	Operating case temperature – Industrial	-40	95	°C	2, 3
T <sub>STG</sub>	Storage temperature	-55	150	°C	

- Notes:
- 1 VDD and VDDQ must be within 300mV of each other at all times, and VREF must not be greater than  $0.6 \times VDDQ$ . When VDD and VDDQ are <500mV, VREF can be  $\leq 300mV$ .
  - 2 MAX operating case temperature. TC is measured in the center of the package.
  - 3 Device functionality is not guaranteed if the DRAM device exceeds the maximum TC during operation.

### Input/Output Capacitance

#### DDR3L Input/Output Capacitance



applies to the entire table

Capacitance Parameters	Sym	DDR3L-1600		DDR3L-1866		DDR3L-2133		Unit	Notes
		Min	Max	Min	Max	Min	Max		
CK and CKB	C <sub>CK</sub>	0.8	1.4	0.8	1.3	0.8	1.3	pF	
ΔC: CK to CKB	C <sub>DCK</sub>	0.0	0.15	0.0	0.15	0.0	0.15	pF	
Single-end I/O: DQ, DM	C <sub>IO</sub>	1.4	2.2	1.4	2.1	1.4	2.1	pF	2
Differential I/O: DQS, DQSB	C <sub>IO</sub>	1.4	2.2	1.4	2.1	1.4	2.1	pF	3
ΔC: DQS to DQSB	C <sub>DDQS</sub>	0.0	0.15	0.0	0.15	0.0	0.15	pF	3
ΔC: DQ to DQS	C <sub>DIO</sub>	-0.5	0.3	-0.5	0.3	-0.5	0.3	pF	4
Inputs (CTRL, CMD, ADDR)	C <sub>I</sub>	0.75	1.2	0.75	1.2	0.75	1.2	pF	5
ΔC: CTRL to CK	C <sub>DI_CTRL</sub>	-0.4	0.2	-0.4	0.2	-0.4	0.2	pF	6
ΔC: CMD_ADDR to CK	C <sub>DI_CMD_ADDR</sub>	-0.4	0.4	-0.4	0.4	-0.4	0.4	pF	7
ZQ pin capacitance	C <sub>ZQ</sub>	-	3.0	-	3.0	-	3.0	pF	
Reset pin capacitance	C <sub>RE</sub>	-	3.0	-	3.0	-	3.0	pF	

- Notes: 1 VDD = 1.35V (1.283–1.45V), VDDQ = VDD, VREF = VSS, f = 100 MHz, TC = 25°C.  
VOUT(DC) = 0.5 × VDDQ, VOUT = 0.1V (peak-to-peak).  
2 DM input is grouped with I/O pins, reflecting the fact that they are matched in loading.  
3 Includes. CDDQS is for DQS vs. DQS# separately.  
4 C<sub>DIO</sub> = C<sub>IO</sub>(DQ) - 0.5 × (C<sub>IO</sub>(DQS) + C<sub>IO</sub>(DQS#)).  
5 Excludes CK, CKB; CTRL = ODT, CSB, and CKE; CMD = RASB, CASB, and WEB; ADDR = A[n:0], BA[2:0].  
6 C<sub>DI\_CTRL</sub> = C<sub>I</sub>(CTRL) - 0.5 × (C<sub>CK</sub>(CK) + C<sub>CK</sub>(CKB)).  
7 C<sub>DI\_CMD\_ADDR</sub> = C<sub>I</sub>(CMD\_ADDR) - 0.5 × (C<sub>CK</sub>(CK) + C<sub>CK</sub>(CKB))





## 5.2 Thermal Characteristics

Thermal Characteristics  
apply to entire table

Parameter	Symbol	Value	Units	Notes
Operating temperature	TC	0 to 85	°C	
		0 to 95	°C	4

- Notes:
- 1 MAX operating case temperature TC is measured in the center of the package, as shown below.
  - 2 A thermal solution must be designed to ensure that the device does not exceed the maximum TC during operation.
  - 3 Device functionality is not guaranteed if the device exceeds maximum TC during operation.
  - 4 If TC exceeds 85°C, the DRAM must be refreshed externally at 2x refresh, which is a 3.9µs interval refresh rate. The use of self refresh temperature (SRT) or automatic self refresh (ASR), must be enabled.

Thermal Measurement Point

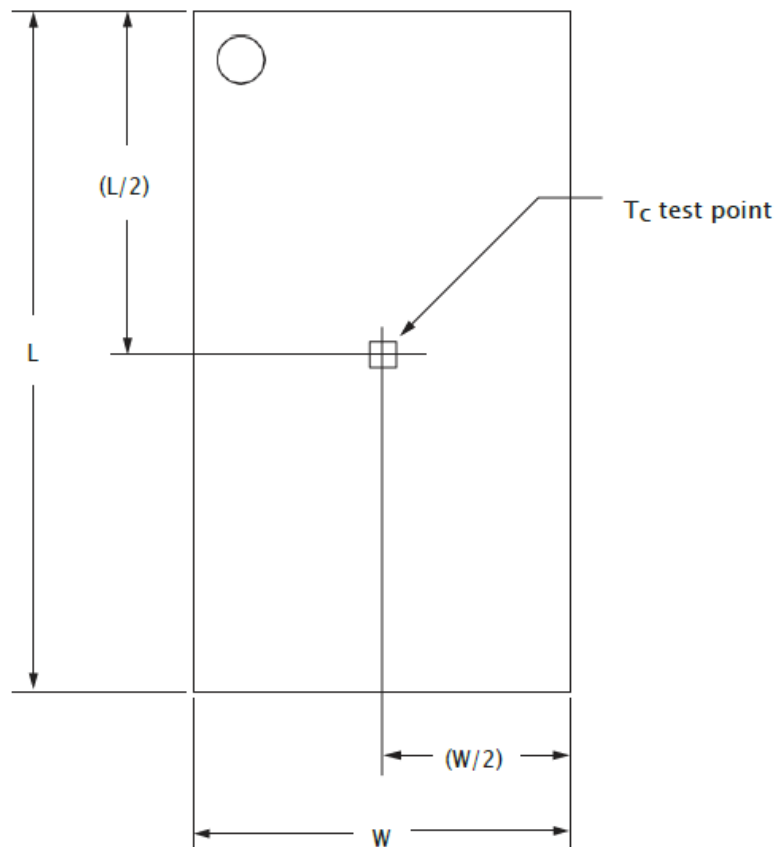

### 5.3 Electrical Specifications – I<sub>DD</sub> Specifications and Conditions

Within the following I<sub>DD</sub> measurement tables, the following definitions and conditions are used, unless state do otherwise:

- LOW:  $V_{IN} \leq V_{IL} (AC)_{max}$ ; HIGH:  $V_{IN} \geq V_{IL} (AC)_{min}$ .
- Midlevel: Inputs are  $V_{REF} = V_{DD}/2$ .
- R<sub>ON</sub> set to RZQ/7 (34Ω).
- R<sub>TT,nom</sub> set to RZQ/6 (40Ω).
- R<sub>TT(WR)</sub> set to RZQ/2 (120Ω).
- Q<sub>OFF</sub> is enabled in MR1.
- ODT is enabled in MR1(R<sub>TT,nom</sub>) and MR2(R<sub>TT(WR)</sub>).
- External DQ/DQS/DM load resistor is 25Ω to  $V_{DDQ}/2$ .
- Burst lengths are BL8 fixed.
- AL equals 0 (except in I<sub>DD7</sub>)
- I<sub>DD</sub> specifications are tested after the device is properly initialized.
- Input slew rate is specified by AC parametric test conditions.
- Optional ASR is disabled.
- Read burst type uses nibble sequential (MR0[3] = 0).
- Loop patterns must be executed at least once before current measurements begin.

Timing Parameters Used for I<sub>DD</sub> Measurements – Clock Units

I <sub>DD</sub> Parameter		DDR3L - 1600		DDR3L- 1866	DDR3L- 2133	Unit
		-125E	-125	-107	-93	
		10-10-10	11-11-11	13-13-13	14-14-14	
t <sub>CK</sub> (MIN) I <sub>DD</sub>		1.25		1.07	0.938	Ns
CL I <sub>DD</sub>		10	11	13	14	CK
t <sub>RCD</sub> (MIN) I <sub>DD</sub>		10	11	13	14	CK
t <sub>RC</sub> (MIN) I <sub>DD</sub>		38	39	45	50	CK
t <sub>RAS</sub> (MIN) I <sub>DD</sub>		28	28	32	36	CK
t <sub>RP</sub> (MIN)		10	11	13	14	CK
t <sub>FAW</sub>	X8	24	24	26	27	CK
t <sub>FAW</sub>	X16	32	32	33	38	CK
t <sub>RRD</sub> I <sub>DD</sub>	X8	5	5	5	6	CK
t <sub>RRD</sub> I <sub>DD</sub>	X16	6	6	6	7	CK
t <sub>RFC</sub>	1Gb	88	88	103	118	CK
	2Gb	128	128	150	172	CK
	4Gb	208	208	243	279	CK



	8Gb	280	280	328	375	CK
--	-----	-----	-----	-----	-----	----

I<sub>DD0</sub> Measurement Loop

CK, CKB	CKE	Sub-Loop	Cycle Number	Command	CSB	RASB	CASB	WEB	ODT	BA[2:0]	A[15:11]	A[10]	A[9:7]	A[6:3]	A[2:0]	Data			
Toggling	Static HIGH	0	0	ACT	0	0	1	1	0	0	0	0	0	0	0	-			
			1	D	1	0	0	0	0	0	0	0	0	0	0	0	-		
			2	D	1	0	0	0	0	0	0	0	0	0	0	0	0	-	
			3	D#	1	1	1	1	1	0	0	0	0	0	0	0	0	-	
			4	D#	1	1	1	1	1	0	0	0	0	0	0	0	0	-	
			Repeat cycles 1 through 4 until $nRAS - 1$ ; truncate if needed																
			$nRAS$	PRE	0	0	1	0	0	0	0	0	0	0	0	0	0	0	-
			Repeat cycles 1 through 4 until $nRC - 1$ ; truncate if needed																
			$nRC$	ACT	0	0	1	1	0	0	0	0	0	0	F	0	0	-	
			$nRC + 1$	D	1	0	0	0	0	0	0	0	0	0	F	0	0	-	
			$nRC + 2$	D	1	0	0	0	0	0	0	0	0	0	F	0	0	-	
			$nRC + 3$	D#	1	1	1	1	0	0	0	0	0	0	F	0	0	-	
			$nRC + 4$	D#	1	1	1	1	0	0	0	0	0	0	F	0	0	-	
			Repeat cycles $nRC + 1$ through $nRC + 4$ until $nRC - 1 + nRAS - 1$ ; truncate if needed																
			$nRC + nRAS$	PRE	0	0	1	0	0	0	0	0	0	0	F	0	0	-	
			Repeat cycles $nRC + 1$ through $nRC + 4$ until $2 \times RC - 1$ ; truncate if needed																
			1	$2 \times nRC$	Repeat sub-loop 0, use BA[2:0] = 1														
		2	$4 \times nRC$	Repeat sub-loop 0, use BA[2:0] = 2															
		3	$6 \times nRC$	Repeat sub-loop 0, use BA[2:0] = 3															
		4	$8 \times nRC$	Repeat sub-loop 0, use BA[2:0] = 4															
		5	$10 \times nRC$	Repeat sub-loop 0, use BA[2:0] = 5															
6	$12 \times nRC$	Repeat sub-loop 0, use BA[2:0] = 6																	
7	$14 \times nRC$	Repeat sub-loop 0, use BA[2:0] = 7																	

- Notes:
1. DQ, DQS, DQSB are midlevel.
  2. DM is LOW.
  3. Only selected bank (single) active.



I<sub>DD1</sub> Measurement Loop

CK, CKB	CKE	Sub-Loop	Cycle Number	Command	CSB	RASB	CASB	WEB	ODT	BA[2:0]	A[15:11]	A[10]	A[9:7]	A[6:3]	A[2:0]	Data <sup>2</sup>			
Toggling	Static HIGH	0	0	ACT	0	0	1	1	0	0	0	0	0	0	0	-			
			1	D	1	0	0	0	0	0	0	0	0	0	0	0	-		
			2	D	1	0	0	0	0	0	0	0	0	0	0	0	-		
			3	D#	1	1	1	1	1	0	0	0	0	0	0	0	-		
			4	D#	1	1	1	1	1	0	0	0	0	0	0	0	-		
			Repeat cycles 1 through 4 until $nRCD - 1$ ; truncate if needed																
			$nRCD$	RD	0	1	0	1	0	0	0	0	0	0	0	0	0	0	00000000
			Repeat cycles 1 through 4 until $nRAS - 1$ ; truncate if needed																
			$nRAS$	PRE	0	0	1	0	0	0	0	0	0	0	0	0	0	-	
			Repeat cycles 1 through 4 until $nRC - 1$ ; truncate if needed																
			$nRC$	ACT	0	0	1	1	0	0	0	0	0	0	F	0	-		
			$nRC + 1$	D	1	0	0	0	0	0	0	0	0	0	F	0	-		
			$nRC + 2$	D	1	0	0	0	0	0	0	0	0	0	F	0	-		
			$nRC + 3$	D#	1	1	1	1	0	0	0	0	0	0	F	0	-		
			$nRC + 4$	D#	1	1	1	1	0	0	0	0	0	0	F	0	-		
			Repeat cycles $nRC + 1$ through $nRC + 4$ until $nRC + nRCD - 1$ ; truncate if needed																
			$nRC + nRCD$	RD	0	1	0	1	0	0	0	0	0	0	F	0	0	00110011	
			Repeat cycles $nRC + 1$ through $nRC + 4$ until $nRC + nRAS - 1$ ; truncate if needed																
			$nRC + nRAS$	PRE	0	0	1	0	0	0	0	0	0	0	F	0	-		
			Repeat cycle $nRC + 1$ through $nRC + 4$ until $2 \times nRC - 1$ ; truncate if needed																
			1	$2 \times nRC$	Repeat sub-loop 0, use BA[2:0] = 1														
			2	$4 \times nRC$	Repeat sub-loop 0, use BA[2:0] = 2														
			3	$6 \times nRC$	Repeat sub-loop 0, use BA[2:0] = 3														
			4	$8 \times nRC$	Repeat sub-loop 0, use BA[2:0] = 4														
			5	$10 \times nRC$	Repeat sub-loop 0, use BA[2:0] = 5														
			6	$12 \times nRC$	Repeat sub-loop 0, use BA[2:0] = 6														
			7	$14 \times nRC$	Repeat sub-loop 0, use BA[2:0] = 7														

- Notes:
- 1 DQ, DQS, DQSB are midlevel unless driven as required by the RD command.
  - 2 DM is LOW.
  - 3 Burst sequence is driven on each DQ signal by the RD command.
  - 4 Only selected bank (single) active.



**I<sub>DD</sub> Measurement Conditions for Power-Down Currents**

Name	I <sub>DD2P0</sub> Precharge Power-Down Current (Slow Exit) <sup>1</sup>	I <sub>DD2P1</sub> Precharge Power-Down Current (Fast Exit) <sup>1</sup>	I <sub>DD2Q</sub> Precharge Quiet Standby Current	I <sub>DD3P</sub> Active Power-Down Current
Timing pattern	N/A	N/A	N/A	N/A
CKE	LOW	LOW	HIGH	LOW
External clock	Toggling	Toggling	Toggling	Toggling
t <sub>CK</sub>	t <sub>CK</sub> (MIN) I <sub>DD</sub>	t <sub>CK</sub> (MIN) I <sub>DD</sub>	t <sub>CK</sub> (MIN) I <sub>DD</sub>	t <sub>CK</sub> (MIN) I <sub>DD</sub>
t <sub>RC</sub>	N/A	N/A	N/A	N/A
t <sub>RAS</sub>	N/A	N/A	N/A	N/A
t <sub>RCD</sub>	N/A	N/A	N/A	N/A
t <sub>RRD</sub>	N/A	N/A	N/A	N/A
t <sub>RC</sub>	N/A	N/A	N/A	N/A
CL	N/A	N/A	N/A	N/A
AL	N/A	N/A	N/A	N/A
CSB	HIGH	HIGH	HIGH	HIGH
Command inputs	LOW	LOW	LOW	LOW
Row/column addr	LOW	LOW	LOW	LOW
Bank addresses	LOW	LOW	LOW	LOW
DM	LOW	LOW	LOW	LOW
Data I/O	Midlevel	Midlevel	Midlevel	Midlevel
Output buffer DQ, DQS	Enabled	Enabled	Enabled	Enabled
ODT <sup>2</sup>	Enabled, off	Enabled, off	Enabled, off	Enabled, off
Burst length	8	8	8	8
Active banks	None	None	None	All
Idle banks	All	All	All	None
Special notes	N/A	N/A	N/A	N/A

- Notes:
- 1 MR0[12] defines DLL on/off behavior during precharge power-down only; DLL on (fast exit, MR0[12] = 1) and DLL off (slow exit, MR0[12] = 0).
  - 2 “Enabled, off” means the MR bits are enabled, but the signal is LOW.



**I<sub>DD2N</sub> and I<sub>DD3N</sub> Measurement Loop**

CK, CKB	CKE	Sub-Loop	Cycle Number	Command	CSB	RASB	CASB	WEB	ODT	BA[2:0]	A[15:11]	A[10]	A[9:7]	A[6:3]	A[2:0]	Data		
Toggling	Static HIGH	0	0	D	1	0	0	0	0	0	0	0	0	0	0	-		
			1	D	1	0	0	0	0	0	0	0	0	0	0	-		
			2	D#	1	1	1	1	1	0	0	0	0	0	F	0	-	
			3	D#	1	1	1	1	1	0	0	0	0	0	F	0	-	
		1	4-7	Repeat sub-loop 0, use BA[2:0] = 1														
		2	8-11	Repeat sub-loop 0, use BA[2:0] = 2														
		3	12-15	Repeat sub-loop 0, use BA[2:0] = 3														
		4	16-19	Repeat sub-loop 0, use BA[2:0] = 4														
		5	20-23	Repeat sub-loop 0, use BA[2:0] = 5														
		6	24-27	Repeat sub-loop 0, use BA[2:0] = 6														
		7	28-31	Repeat sub-loop 0, use BA[2:0] = 7														

- Notes:
1. DQ, DQS, DQSB are midlevel.
  2. DM is LOW.
  3. All banks closed during I<sub>DD2N</sub>; all banks open during I<sub>DD3N</sub>.

**I<sub>DD2NT</sub> Measurement Loop**

CK, CKB	CKE	Sub-Loop	Cycle Number	Command	CSB	RASB	CASB	WEB	ODT	BA[2:0]	A[15:11]	A[10]	A[9:7]	A[6:3]	A[2:0]	Data		
Toggling	Static HIGH	0	0	D	1	0	0	0	0	0	0	0	0	0	0	-		
			1	D	1	0	0	0	0	0	0	0	0	0	0	-		
			2	D#	1	1	1	1	1	0	0	0	0	0	F	0	-	
			3	D#	1	1	1	1	1	0	0	0	0	0	F	0	-	
		1	4-7	Repeat sub-loop 0, use BA[2:0] = 1; ODT = 0														
		2	8-11	Repeat sub-loop 0, use BA[2:0] = 2; ODT = 1														
		3	12-15	Repeat sub-loop 0, use BA[2:0] = 3; ODT = 1														
		4	16-19	Repeat sub-loop 0, use BA[2:0] = 4; ODT = 0														
		5	20-23	Repeat sub-loop 0, use BA[2:0] = 5; ODT = 0														
		6	24-27	Repeat sub-loop 0, use BA[2:0] = 6; ODT = 1														
		7	28-31	Repeat sub-loop 0, use BA[2:0] = 7; ODT = 1														

- Notes:
1. DQ, DQS, DQSB are midlevel.
  2. DM is LOW.
  3. All banks closed.



**I<sub>DD4R</sub> Measurement Loop**

CK, CKB	CKE	Sub-Loop	Cycle Number	Command	CSB	RASB	CASB	WEB	ODT	BA[2:0]	A[15:11]	A[10]	A[9:7]	A[6:3]	A[2:0]	Data <sup>3</sup>		
Toggling	Static HIGH	0	0	RD	0	1	0	1	0	0	0	0	0	0	0	00000000		
			1	D	1	0	0	0	0	0	0	0	0	0	0	0	-	
			2	D#	1	1	1	1	1	0	0	0	0	0	0	0	0	-
			3	D#	1	1	1	1	1	0	0	0	0	0	0	0	0	-
			4	RD	0	1	0	1	0	0	0	0	0	0	F	0	00110011	
			5	D	1	0	0	0	0	0	0	0	0	0	F	0	-	
			6	D#	1	1	1	1	1	0	0	0	0	0	F	0	-	
			7	D#	1	1	1	1	1	0	0	0	0	0	F	0	-	
		1	8–15	Repeat sub-loop 0, use BA[2:0] = 1														
		2	16–23	Repeat sub-loop 0, use BA[2:0] = 2														
		3	24–31	Repeat sub-loop 0, use BA[2:0] = 3														
		4	32–39	Repeat sub-loop 0, use BA[2:0] = 4														
		5	40–47	Repeat sub-loop 0, use BA[2:0] = 5														
		6	48–55	Repeat sub-loop 0, use BA[2:0] = 6														
		7	56–63	Repeat sub-loop 0, use BA[2:0] = 7														

- Notes:
1. DQ, DQS, DQSB are midlevel when not driving in burst sequence.
  2. DM is LOW.
  3. Burst sequence is driven on each DQ signal by the RD command.
  4. All banks open.



**I<sub>DD4W</sub> Measurement Loop**

CK, CKB	CKE	Sub-Loop	Cycle Number	Command	CSB	RASB	CASB	WEB	ODT	BA[2:0]	A[15:11]	A[10]	A[9:7]	A[6:3]	A[2:0]	Data <sup>4</sup>		
Toggling	Static HIGH	0	0	WR	0	1	0	0	1	0	0	0	0	0	0	00000000		
			1	D	1	0	0	0	1	0	0	0	0	0	0	0	-	
			2	D#	1	1	1	1	1	1	0	0	0	0	0	0	0	-
			3	D#	1	1	1	1	1	1	0	0	0	0	0	0	0	-
			4	WR	0	1	0	0	0	1	0	0	0	0	F	0	00110011	
			5	D	1	0	0	0	0	1	0	0	0	0	F	0	-	
			6	D#	1	1	1	1	1	1	0	0	0	0	F	0	-	
			7	D#	1	1	1	1	1	1	0	0	0	0	F	0	-	
		1	8-15	Repeat sub-loop 0, use BA[2:0] = 1														
		2	16-23	Repeat sub-loop 0, use BA[2:0] = 2														
		3	24-31	Repeat sub-loop 0, use BA[2:0] = 3														
		4	32-39	Repeat sub-loop 0, use BA[2:0] = 4														
		5	40-47	Repeat sub-loop 0, use BA[2:0] = 5														
		6	48-55	Repeat sub-loop 0, use BA[2:0] = 6														
		7	56-63	Repeat sub-loop 0, use BA[2:0] = 7														

- Notes:
1. DQ, DQS, DQSB are midlevel when not driving in burst sequence.
  2. DM is LOW.
  3. Burst sequence is driven on each DQ signal by the WR command.
  4. All banks open.

**I<sub>DD5B</sub> Measurement Loop**

CK, CKB	CKE	Sub-Loop	Cycle Number	Command	CSB	RASB	CASB	WEB	ODT	BA[2:0]	A[15:11]	A[10]	A[9:7]	A[6:3]	A[2:0]	Data		
Toggling	Static HIGH	1a	0	REF	0	0	0	1	0	0	0	0	0	0	0	-		
			1	D	1	0	0	0	0	0	0	0	0	0	0	0	-	
			2	D	1	0	0	0	0	0	0	0	0	0	0	0	-	
			3	D#	1	1	1	1	0	0	0	0	0	0	F	0	-	
			4	D#	1	1	1	1	0	0	0	0	0	0	F	0	-	
		1b	5-8	Repeat sub-loop 1a, use BA[2:0] = 1														
		1c	9-12	Repeat sub-loop 1a, use BA[2:0] = 2														
		1d	13-16	Repeat sub-loop 1a, use BA[2:0] = 3														
		1e	17-20	Repeat sub-loop 1a, use BA[2:0] = 4														
		1f	21-24	Repeat sub-loop 1a, use BA[2:0] = 5														
		1g	25-28	Repeat sub-loop 1a, use BA[2:0] = 6														
		1h	29-32	Repeat sub-loop 1a, use BA[2:0] = 7														
		2	33-nRFC - 1	Repeat sub-loop 1a through 1h until nRFC - 1; truncate if needed														

- Notes:
1. DQ, DQS, DQSB are midlevel.
  2. DM is LOW.





**I<sub>DD</sub> Measurement Conditions for I<sub>DD6</sub>, I<sub>DD6ET</sub>, and I<sub>DD8</sub>**

I <sub>DD</sub> Test	I <sub>DD6</sub> : Self Refresh Current Normal Temperature Range T <sub>C</sub> = 0°C to +85°C	I <sub>DD6ET</sub> : Self Refresh Current Extended Temperature Range T <sub>C</sub> = 0°C to +95°C	I <sub>DD8</sub> : Reset <sup>2</sup>
CKE	LOW	LOW	Midlevel
External clock	Off, CK and CKB = LOW	Off, CK and CKB = LOW	Midlevel
t <sup>1</sup> CK	N/A	N/A	N/A
t <sup>1</sup> RC	N/A	N/A	N/A
t <sup>1</sup> RAS	N/A	N/A	N/A
t <sup>1</sup> RCD	N/A	N/A	N/A
t <sup>1</sup> RRD	N/A	N/A	N/A
t <sup>1</sup> RC	N/A	N/A	N/A
CL	N/A	N/A	N/A
AL	N/A	N/A	N/A
CSB	Midlevel	Midlevel	Midlevel
Command inputs	Midlevel	Midlevel	Midlevel
Row/column addresses	Midlevel	Midlevel	Midlevel
Bank addresses	Midlevel	Midlevel	Midlevel
Data I/O	Midlevel	Midlevel	Midlevel
Output buffer DQ, DQS	Enabled	Enabled	Midlevel
ODT <sup>1</sup>	Enabled, midlevel	Enabled, midlevel	Midlevel
Burst length	N/A	N/A	N/A
Active banks	N/A	N/A	None
Idle banks	N/A	N/A	All
SRT	Disabled (normal)	Enabled (extended)	N/A
ASR	Disabled	Disabled	N/A

- Notes: 1. "Enabled, midlevel" means the MR command is enabled, but the signal is midlevel.  
 2. During a cold boot RESET (initialization), current reading is valid after power is stable and RESET has been LOW for 1ms; During a warm boot RESET (while operating), current reading is valid after RESET has been LOW for 200ns + t<sup>1</sup>RFC.



I<sub>DD7</sub> Measurement Loop

CK, CKB	CKE	Sub-Loop	Cycle Number	Command	CSB	RASB	CASB	WEB	ODT	BA[2:0]	A[15:11]	A[10]	A[9:7]	A[6:3]	A[2:0]	Data <sup>3</sup>		
Toggling	Static HIGH	0	0	ACT	0	0	1	1	0	0	0	0	0	0	0	-		
			1	RDA	0	1	0	1	0	0	0	1	0	0	0	00000000		
			2	D	1	0	0	0	0	0	0	0	0	0	0	0	-	
			3	Repeat cycle 2 until $nRRD - 1$														
		1	$nRRD$	ACT	0	0	1	1	0	1	0	0	0	0	F	0	-	
			$nRRD + 1$	RDA	0	1	0	1	0	1	0	1	0	1	0	F	0	00110011
			$nRRD + 2$	D	1	0	0	0	0	0	0	1	0	0	0	F	0	-
			$nRRD + 3$	Repeat cycle $nRRD + 2$ until $2 \times nRRD - 1$														
		2	$2 \times nRRD$	Repeat sub-loop 0, use BA[2:0] = 2														
		3	$3 \times nRRD$	Repeat sub-loop 1, use BA[2:0] = 3														
		4	$4 \times nRRD$	D	1	0	0	0	0	0	0	3	0	0	0	F	0	-
			$4 \times nRRD + 1$	Repeat cycle $4 \times nRRD$ until $nFAW - 1$ , if needed														
		5	$nFAW$	Repeat sub-loop 0, use BA[2:0] = 4														
		6	$nFAW + nRRD$	Repeat sub-loop 1, use BA[2:0] = 5														
		7	$nFAW + 2 \times nRRD$	Repeat sub-loop 0, use BA[2:0] = 6														
		8	$nFAW + 3 \times nRRD$	Repeat sub-loop 1, use BA[2:0] = 7														
		9	$nFAW + 4 \times nRRD$	D	1	0	0	0	0	0	0	7	0	0	0	F	0	-
			$nFAW + 4 \times nRRD + 1$	Repeat cycle $nFAW + 4 \times nRRD$ until $2 \times nFAW - 1$ , if needed														
		10	$2 \times nFAW$	ACT	0	0	1	1	0	0	0	0	0	0	0	F	0	-
			$2 \times nFAW + 1$	RDA	0	1	0	1	0	0	0	0	0	1	0	F	0	00110011
			$2 \times nFAW + 2$	D	1	0	0	0	0	0	0	0	0	0	0	F	0	-
			$2 \times nFAW + 3$	Repeat cycle $2 \times nFAW + 2$ until $2 \times nFAW + nRRD - 1$														
		11	$2 \times nFAW + nRRD$	ACT	0	0	1	1	0	1	0	0	0	0	0	0	0	-
			$2 \times nFAW + nRRD + 1$	RDA	0	1	0	1	0	1	0	1	0	1	0	0	0	00000000
			$2 \times nFAW + nRRD + 2$	D	1	0	0	0	0	0	0	1	0	0	0	0	0	-
			$2 \times nFAW + nRRD + 3$	Repeat cycle $2 \times nFAW + nRRD + 2$ until $2 \times nFAW + 2 \times nRRD - 1$														
		12	$2 \times nFAW + 2 \times nRRD$	Repeat sub-loop 10, use BA[2:0] = 2														
		13	$2 \times nFAW + 3 \times nRRD$	Repeat sub-loop 11, use BA[2:0] = 3														
		14	$2 \times nFAW + 4 \times nRRD$	D	1	0	0	0	0	0	0	3	0	0	0	0	0	-
			$2 \times nFAW + 4 \times nRRD + 1$	Repeat cycle $2 \times nFAW + 4 \times nRRD$ until $3 \times nFAW - 1$ , if needed														
15	$3 \times nFAW$	Repeat sub-loop 10, use BA[2:0] = 4																



**Idd7 Measurement Loop (Continued)**

CK, CKB	CKE	Sub-Loop	Cycle Number	Command	CSB	RASB	CASB	WEB	ODT	BA[2:0]	A[15:11]	A[10]	A[9:7]	A[6:3]	A[2:0]	Data <sup>3</sup>	
Toggling	Static HIGH	16	$3 \times nFAW + nRRD$	Repeat sub-loop 11, use BA[2:0] = 5													
		17	$3 \times nFAW + 2 \times nRRD$	Repeat sub-loop 10, use BA[2:0] = 6													
		18	$3 \times nFAW + 3 \times nRRD$	Repeat sub-loop 11, use BA[2:0] = 7													
		19	$3 \times nFAW + 4 \times nRRD$	D	1	0	0	0	0	0	7	0	0	0	0	0	-
			$3 \times nFAW + 4 \times nRRD + 1$	Repeat cycle $3 \times nFAW + 4 \times nRRD$ until $4 \times nFAW - 1$ , if needed													

- Notes:
1. DQ, DQS, DQSB are midlevel unless driven as required by the RD command.
  2. DM is LOW.
  3. Burst sequence is driven on each DQ signal by the RD command.
  4. AL = CL-1.



## 5.4 Electrical Characteristics – Operating IDD Specifications

IDD Maximum Limits Die for 1.35/1.5V Operation

Parameter	Speed		DDR3/3L -1600	DDR3/3L -1866	DDR3/3L -2133	Units	Notes
	Symbol	Width					
Operating current 0: One bank ACTIVATE-to-PRECHARGE	I <sub>DD0</sub>	X8	47	49	51	mA	1, 2
		X16	57	59	61	mA	1, 2
Operating current 1: One bank ACTIVATE-to-READ-to-PRECHARGE	I <sub>DD1</sub>	X8	61	64	67	mA	1, 2
		X16	81	84	87	mA	1, 2
Precharge power-down current: Slow exit	I <sub>DD2P0</sub>	All	8	8	8	mA	1, 2
Precharge power-down current: Fast exit	I <sub>DD2P1</sub>	All	14	16	18	mA	1, 2
Precharge quiet standby current	I <sub>DD2Q</sub>	All	24	26	28	mA	1, 2
Precharge standby current	I <sub>DD2N</sub>	All	24	26	28	mA	1, 2
Precharge standby ODT current	I <sub>DD2NT</sub>	X8	28	30	32	mA	1, 2
		X16	31	33	35	mA	1, 2
Active power-down current	I <sub>DD3P</sub>	All	26	28	30	mA	1, 2
Active standby current	I <sub>DD3N</sub>	X8	30	32	34	mA	1, 2
		X16	38	40	42	mA	1, 2
Burst read operating current	I <sub>DD4R</sub>	X8	95	105	115	mA	1, 2
		X16	155	165	175	mA	1, 2
Burst write operating current	I <sub>DD4W</sub>	X8	95	105	115	mA	1, 2
		X16	155	165	175	mA	1, 2
Burst refresh current	I <sub>DD5B</sub>	All	235	242	185	mA	1, 2
Room temperature self refresh	I <sub>DD6</sub>	All	12	12	12	mA	1, 2, 3
Extended temperature self refresh	I <sub>DD6ET</sub>	All	16	16	16	mA	2, 4
All banks interleaved read current	I <sub>DD7</sub>	X8	130	140	150	mA	1, 2
		X16	190	200	210	mA	1, 2
Reset current	I <sub>DD8</sub>	All	I <sub>DD2P</sub> + 2mA	I <sub>DD2P</sub> + 2mA	I <sub>DD2P</sub> + 2mA	mA	1, 2

- Notes:
- 1 TC = 85°C; SRT and ASR are disabled.
  - 2 Enabling ASR could increase IDD<sub>x</sub> by up to an additional 2mA.
  - 3 Restricted to TC (MAX) = 85°C.
  - 4 TC = 85°C; ASR and ODT are disabled; SRT is enabled.
  - 5 The IDD values must be derated (increased) on IT-option devices when operated outside of the range 0°C ≤ TC ≤ +85°C:
    - 5a. When TC < 0°C: IDD2P0, IDD2P1 and IDD3P must be derated by 4%; IDD4R and IDD4W must be derated by 2%; and IDD6, IDD6ET and IDD7 must be derated by 7%.



5b. When TC > 85°C: IDD0, IDD1, IDD2N, IDD2NT, IDD2Q, IDD3N, IDD3P, IDD4R, IDD4W, and IDD5B must be derated by 2%; IDD2Px must be derated by 30%.

## 5.5 Electrical Specifications – DC and AC

### DC Operating Conditions

#### DDR3L 1.35V DC Electrical Characteristics and Operating Conditions

All voltages are referenced to V<sub>SS</sub>

Parameter/Condition	Symbol	Min	Nom	Max	Unit	Notes
Supply voltage	V <sub>DD</sub>	1.283	1.35	1.45	V	1–7
I/O supply voltage	V <sub>DDQ</sub>	1.283	1.35	1.45	V	1–7
Input leakage current Any input 0V ≤ V <sub>IN</sub> ≤ V <sub>DD</sub> , V <sub>REF</sub> pin 0V ≤ V <sub>IN</sub> ≤ 1.1V (All other pins not under test = 0V)	I <sub>I</sub>	-2	-	2	μA	
V <sub>REF</sub> supply leakage current V <sub>REFDQ</sub> = V <sub>DD</sub> /2 or V <sub>REFCA</sub> = V <sub>DD</sub> /2 (All other pins not under test = 0V)	I <sub>VREF</sub>	-1	-	1	μA	8, 9

- Notes:
- 1 VDD and VDDQ must track one another. VDDQ must be ≤ VDD. VSS = VSSQ.
  - 2 VDD and VDDQ may include AC noise of ±50mV (250 kHz to 20 MHz) in addition to the DC (0 Hz to 250 kHz) specifications. VDD and VDDQ must be at same level for valid AC timing parameters.
  - 3 Maximum DC value may not be greater than 1.425V. The DC value is the linear average of VDD/VDDQ(t) over a very long period of time (for example, 1 second).
  - 4 Under these supply voltages, the device operates to this DDR3L specification.
  - 5 If the maximum limit is exceeded, input levels shall be governed by DDR3 specifications.
  - 6 Under 1.5V operation, this DDR3L device operates in accordance with the DDR3 specifications under the same speed timings as defined for this device.
  - 7 Once initialized for DDR3L operation, DDR3 operation may only be used if the device is in reset while VDD and VDDQ are changed for DDR3 operation (see VDD Voltage Switching).
  - 8 The minimum limit requirement is for testing purposes. The leakage current on the VREF pin should be minimal.
  - 9 VREF.



## Input Operating Conditions

### DDR3L 1.35V DC Electrical Characteristics and Input Conditions

All voltages are referenced to  $V_{SS}$

Parameter/Condition	Symbol	Min	Nom	Max	Unit	Notes
$V_{IN}$ low; DC/commands/address busses	$V_{IL}$	$V_{SS}$	N/A		V	
$V_{IN}$ high; DC/commands/address busses	$V_{IH}$		N/A	$V_{DD}$	V	
Input reference voltage command/address bus	$V_{REFCA(DC)}$	$0.49 \times V_{DD}$	$0.5 \times V_{DD}$	$0.51 \times V_{DD}$	V	1, 2
I/O reference voltage DQ bus	$V_{REFDQ(DC)}$	$0.49 \times V_{DD}$	$0.5 \times V_{DD}$	$0.51 \times V_{DD}$	V	2, 3
I/O reference voltage DQ bus in SELF REFRESH	$V_{REFDQ(SR)}$	$V_{SS}$	$0.5 \times V_{DD}$	$V_{DD}$	V	4
Command/address termination voltage (system level, not direct DRAM input)	$V_{TT}$	–	$0.5 \times V_{DDQ}$	–	V	5

- Notes:
- $V_{REFCA(DC)}$  is expected to be approximately  $0.5 \times V_{DD}$  and to track variations in the DC level. Externally generated peak noise (non-common mode) on  $V_{REFCA}$  may not exceed  $\pm 1\% \times V_{DD}$  around the  $V_{REFCA(DC)}$  value. Peak-to-peak AC noise on  $V_{REFCA}$  should not exceed  $\pm 2\%$  of  $V_{REFCA(DC)}$ .
  - DC values are determined to be less than 20 MHz in frequency. DRAM must meet specifications if the DRAM induces additional AC noise greater than 20 MHz in frequency.
  - $V_{REFDQ(DC)}$  is expected to be approximately  $0.5 \times V_{DD}$  and to track variations in the DC level. Externally generated peak noise (non-common mode) on  $V_{REFDQ}$  may not exceed  $\pm 1\% \times V_{DD}$  around the  $V_{REFDQ(DC)}$  value. Peak-to-peak AC noise on  $V_{REFDQ}$  should not exceed  $\pm 2\%$  of  $V_{REFDQ(DC)}$ .
  - $V_{REFDQ(DC)}$  may transition to  $V_{REFDQ(SR)}$  and back to  $V_{REFDQ(DC)}$  when in SELF REFRESH, within restrictions outlined in the SELF REFRESH section.
  - $V_{TT}$  is not applied directly to the device.  $V_{TT}$  is a system supply for signal termination resistors. Minimum and maximum values are system-dependent.



**DDR3L 1.35V Input Switching Conditions – Command and Address**

Parameter/Condition	Symbol	DDR3L-1600	DDR3L-1866/2133	Units
<b>Command and Address</b>				
Input high AC voltage: Logic 1	$V_{IH(AC160),min}^5$	160	–	mV
	$V_{IH(AC135),min}^5$	135	135	mV
	$V_{IH(AC125),min}^5$	–	125	mV
Input high DC voltage: Logic 1	$V_{IH(DC90),min}$	90	90	mV
Input low DC voltage: Logic 0	$V_{IL(DC90),min}$	–90	–90	mV
Input low AC voltage: Logic 0	$V_{IL(AC125),min}^5$	–	–125	mV
	$V_{IL(AC135),min}^5$	–135	–135	mV
	$V_{IL(AC160),min}^5$	–160	–	mV
<b>DQ and DM</b>				
Input high AC voltage: Logic 1	$V_{IH(AC160),min}^5$	160	–	mV
	$V_{IH(AC135),min}^5$	135	135	mV
	$V_{IH(AC125),min}$	–	130	mV
Input high DC voltage: Logic 1	$V_{IH(DC90),min}$	90	90	mV
Input low DC voltage: Logic 0	$V_{IL(DC90),min}$	–90	–90	mV
Input low AC voltage: Logic 0	$V_{IL(AC125),min}^5$	–	–130	mV
	$V_{IL(AC135),min}^5$	–135	–135	mV
	$V_{IL(AC160),min}^5$	–160	–	mV

- Notes:
1. All voltages are referenced to  $V_{REF}$ .  $V_{REF}$  is  $V_{REFCA}$  for control, command, and address. All slew rates and setup/hold times are specified at the DRAM ball.  $V_{REF}$  is  $V_{REFDQ}$  for DQ and DM inputs.
  2. Input setup timing parameters ( $t_{IS}$  and  $t_{DS}$ ) are referenced at  $V_{IL(AC)}/V_{IH(AC)}$ , not  $V_{REF(DC)}$ .
  3. Input hold timing parameters ( $t_{IH}$  and  $t_{DH}$ ) are referenced at  $V_{IL(DC)}/V_{IH(DC)}$ , not  $V_{REF(DC)}$ .
  4. Single-ended input slew rate = 1 V/ns; maximum input voltage swing under test is 900mV (peak-to-peak).
  5. When two  $V_{IH(AC)}$  values (and two corresponding  $V_{IL(AC)}$  values) are listed for a specific speed bin, the user may choose either value for the input AC level. Whichever value is used, the associated setup time for that AC level must also be used. Additionally, one  $V_{IH(AC)}$  value may be used for address/command inputs and the other  $V_{IH(AC)}$  value may be used for data inputs.



**DDR3L 1.35V Differential Input Operating Conditions (CK, CKB and DQS, DQS#)**

Parameter/Condition	Symbol	Min	Max	Units	Notes
Differential input logic high – slew	$V_{IH,diff(AC)slew}$	180	N/A	mV	4
Differential input logic low – slew	$V_{IL,diff(AC)slew}$	N/A	-180	mV	4
Differential input logic high	$V_{IH,diff(AC)}$	$2 \times (V_{IH(AC)} - V_{REF})$	$V_{DD}/V_{DDQ}$	mV	5
Differential input logic low	$V_{IL,diff(AC)}$	$V_{SS}/V_{SSQ}$	$2 \times (V_{IL(AC)} - V_{REF})$	mV	6
Differential input crossing voltage relative to $V_{DD}/2$ for DQS, DQS#; CK, CKB	$V_{IX}$	$V_{REF(DC)} - 150$	$V_{REF(DC)} + 150$	mV	5, 7, 9
Differential input crossing voltage relative to $V_{DD}/2$ for CK, CKB	$V_{IX(175)}$	$V_{REF(DC)} - 175$	$V_{REF(DC)} + 175$	mV	5, 7–9
Single-ended high level for strobes	$V_{SEH}$	$V_{DDQ}/2 + 160$	$V_{DDQ}$	mV	5
Single-ended high level for CK, CKB		$V_{DD}/2 + 160$	$V_{DD}$	mV	5
Single-ended low level for strobes	$V_{SEL}$	$V_{SSQ}$	$V_{DDQ}/2 - 160$	mV	6
Single-ended low level for CK, CKB		$V_{SS}$	$V_{DD}/2 - 160$	mV	6

- Notes:
1. Clock is referenced to  $V_{DD}$  and  $V_{SS}$ . Data strobe is referenced to  $V_{DDQ}$  and  $V_{SSQ}$ .
  2. Reference is  $V_{REFCA(DC)}$  for clock and  $V_{REFDQ(DC)}$  for strobe.
  3. Differential input slew rate = 2 V/ns.
  4. Defines slew rate reference points, relative to input crossing voltages.
  5. Minimum DC limit is relative to single-ended signals; overshoot specifications are applicable.
  6. Maximum DC limit is relative to single-ended signals; undershoot specifications are applicable.
  7. The typical value of  $V_{IX(AC)}$  is expected to be about  $0.5 \times V_{DD}$  of the transmitting device, and  $V_{IX(AC)}$  is expected to track variations in  $V_{DD}$ .  $V_{IX(AC)}$  indicates the voltage at which differential input signals must cross.
  8. The  $V_{IX}$  extended range ( $\pm 175\text{mV}$ ) is allowed only for the clock; this  $V_{IX}$  extended range is only allowed when the following conditions are met: The single-ended input signals are monotonic, have the single-ended swing  $V_{SEL}$ ,  $V_{SEH}$  of at least  $V_{DD}/2 \pm 250\text{mV}$ , and the differential slew rate of CK, CKB is greater than 3 V/ns.
  9.  $V_{IX}$  must provide 25mV (single-ended) of the voltages separation.





DDR3L 1.35V Input Signal

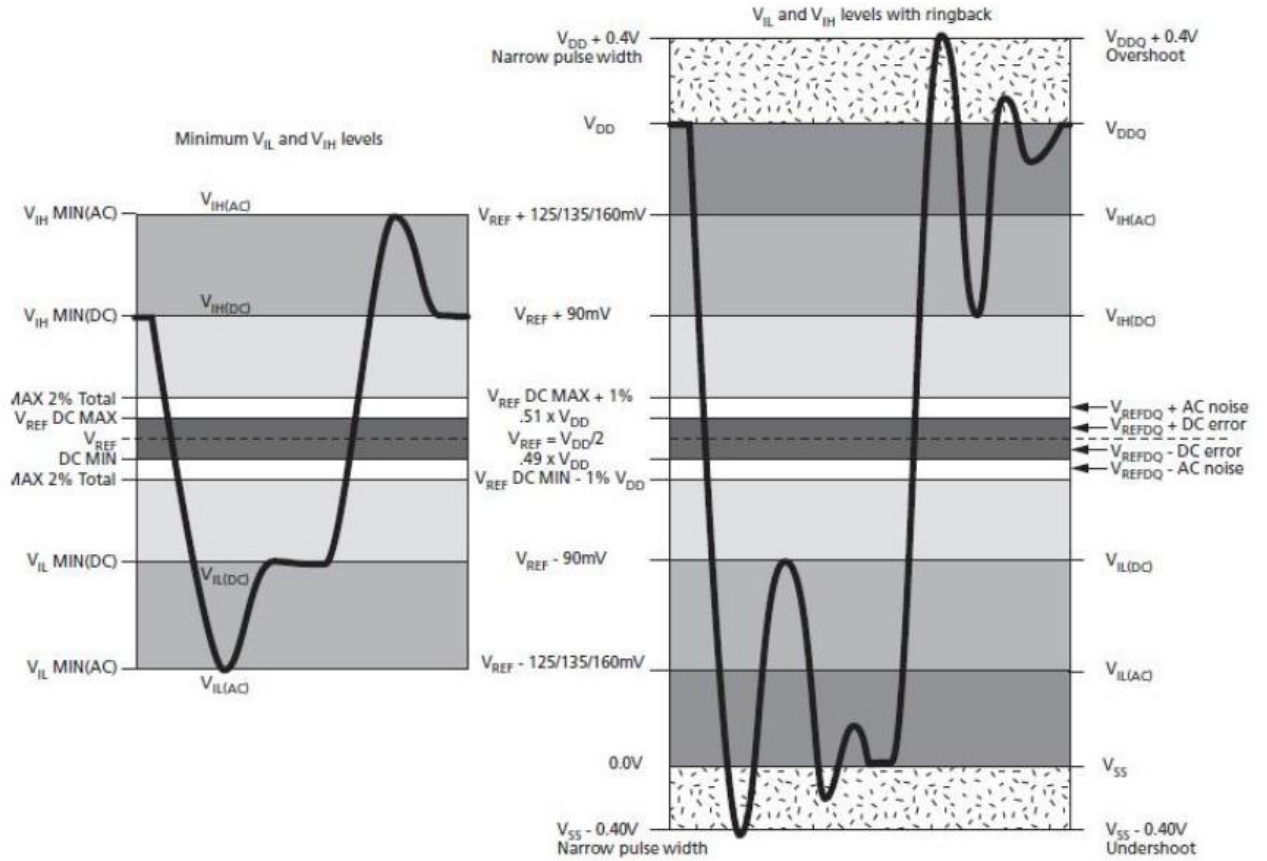

Note: 1. Numbers in diagrams reflect nominal values.

DDR3L 1.35V AC Overshoot/Undershoot Specification



**DDR3L Control and Address Pins**

Parameter	DDR3L-1600	DDR3L-1866	DDR3L-2133
Maximum peak amplitude allowed for overshoot area	0.4V	0.4V	0.4V
Maximum peak amplitude allowed for undershoot area	0.4V	0.4V	0.4V
Maximum overshoot area above $V_{DD}$	0.33 V/ns	0.28 V/ns	0.25 V/ns
Maximum undershoot area below $V_{SS}$	0.33 V/ns	0.28 V/ns	0.25 V/ns

**DDR3L 1.35V Clock, Data, Strobe, and Mask Pins**

Parameter	DDR3L-1600	DDR3L-1866	DDR3L-2133
Maximum peak amplitude allowed for overshoot area	0.4V	0.4V	0.4V
Maximum peak amplitude allowed for undershoot area	0.4V	0.4V	0.4V
Maximum overshoot area above $V_{DD}/V_{DDQ}$	0.13 V/ns	0.11 V/ns	0.1 V/ns
Maximum undershoot area below $V_{SS}/V_{SSQ}$	0.13 V/ns	0.11 V/ns	0.1 V/ns

**Overshoot**

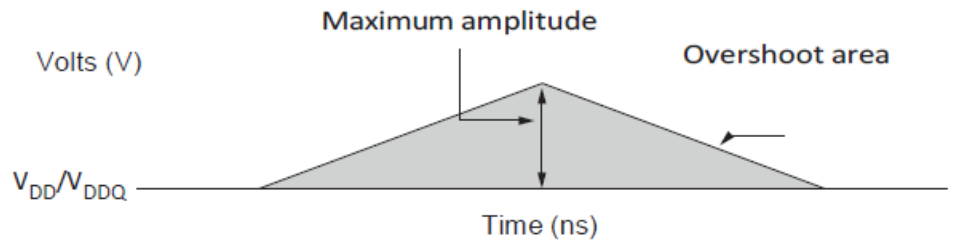

### Undershoot

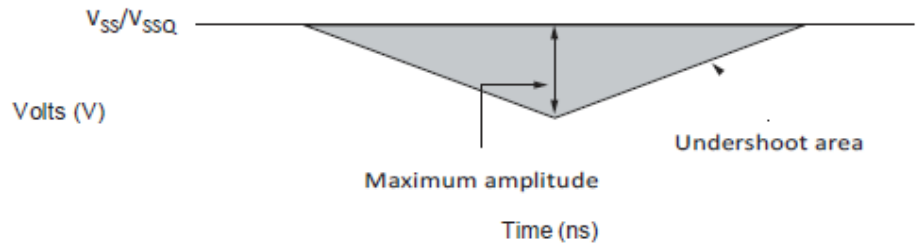

### $V_{IX}$ for Differential Signals

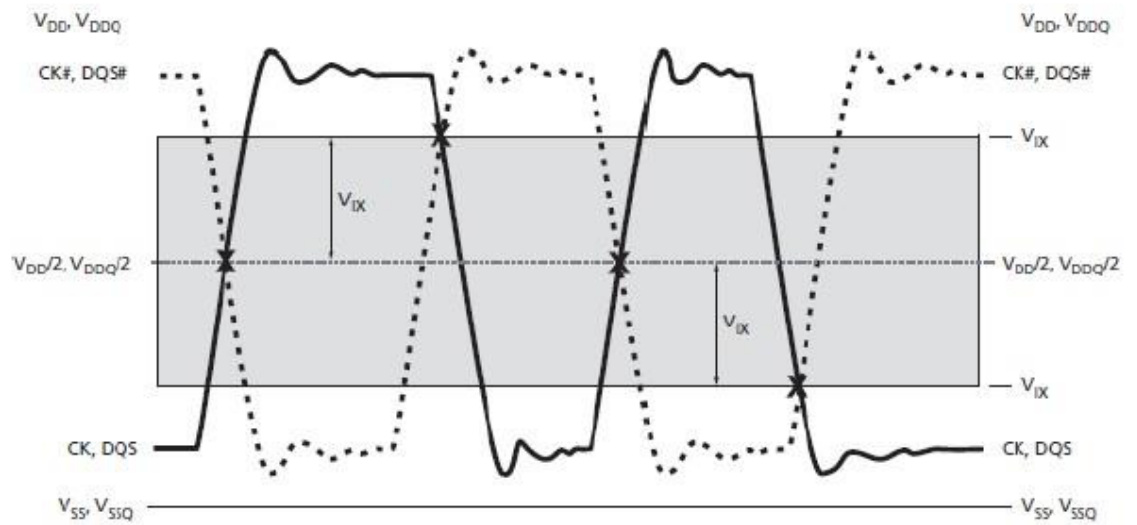

### Single-Ended Requirements for Differential Signals

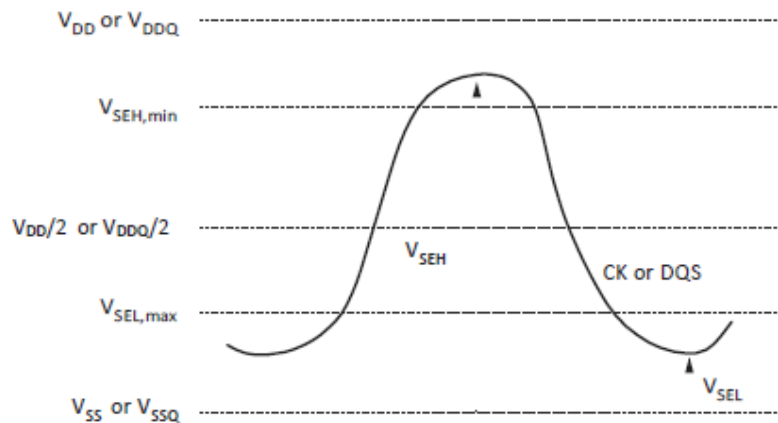

**Definition of Differential AC-Swing and <sup>t</sup>DVAC**

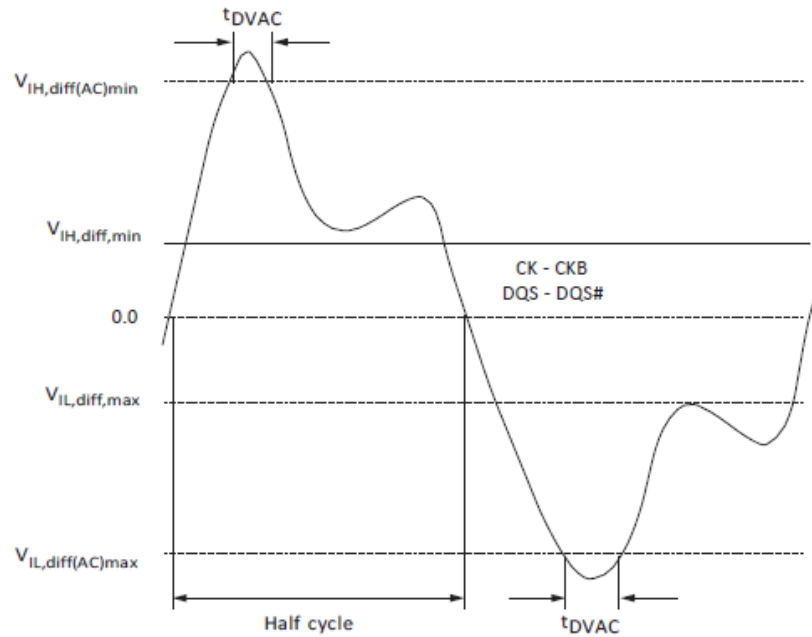

**DDR3L 1.35V – Minimum Required Time <sup>t</sup>DVAC for CK/CKB, DQS/DQS# Differential for AC Ringback**

Slew Rate (V/ns)	DDR3L-1600		DDR3L-1866/2133		
	<sup>t</sup> DVAC at 320mV (ps)	<sup>t</sup> DVAC at 270mV (ps)	<sup>t</sup> DVAC at 270mV (ps)	<sup>t</sup> DVAC at 250mV (ps)	<sup>t</sup> DVAC at 260mV (ps)
>4.0	189	201	163	168	176
4.0	189	201	163	168	176
3.0	162	179	140	147	154
2.0	109	134	95	105	111
1.8	91	119	80	91	97
1.6	69	100	62	74	78
1.4	40	76	37	52	55
1.2	Note 1	44	5	22	24
1.0	Note 1				
<1.0	Note 1				

Note: 1. Rising input signal shall become equal to or greater than  $V_{IH(AC)}$  level and Falling input signal shall become equal to or less than  $V_{IL(AC)}$  level.



### DDR3L 1.35V Slew Rate Definitions for Single-Ended Input Signals

Setup (<sup>t</sup>IS and <sup>t</sup>DS) nominal slew rate for a rising signal is defined as the slew rate between the last crossing of  $V_{REF}$  and the first crossing of  $V_{IH(AC),min}$ . Setup (<sup>t</sup>IS and <sup>t</sup>DS) nominal slew rate for a falling signal is defined as the slew rate between the last crossing of  $V_{REF}$  and the first crossing of  $V_{IL(AC),max}$ .

Hold (<sup>t</sup>IH and <sup>t</sup>DH) nominal slew rate for a rising signal is defined as the slew rate between the last crossing of  $V_{IL(DC),max}$  and the first crossing of  $V_{REF}$ . Hold (<sup>t</sup>IH and <sup>t</sup>DH) nominal slew rate for a falling signal is defined as the slew rate between the last crossing of  $V_{IH(DC),min}$  and the first crossing of  $V_{REF}$ .

#### Single-Ended Input Slew Rate Definition

Input Slew Rates (Linear Signals)		Measured		Calculation
Input	Edge	From	To	
Setup	Rising	$V_{REF}$	$V_{IH(AC),min}$	$\frac{V_{IH(AC),min} - V_{REF}}{\Delta TRS_{se}}$
	Falling	$V_{REF}$	$V_{IL(AC),max}$	$\frac{V_{REF} - V_{IL(AC),max}}{\Delta TFS_{se}}$
Hold	Rising	$V_{IL(DC),max}$	$V_{REF}$	$\frac{V_{REF} - V_{IL(DC),max}}{\Delta TFH_{se}}$
	Falling	$V_{IH(DC),min}$	$V_{REF}$	$\frac{V_{IH(DC),min} - V_{REF}}{\Delta TRSH_{se}}$



**Nominal Slew Rate Definition for Single-Ended Input Signals**

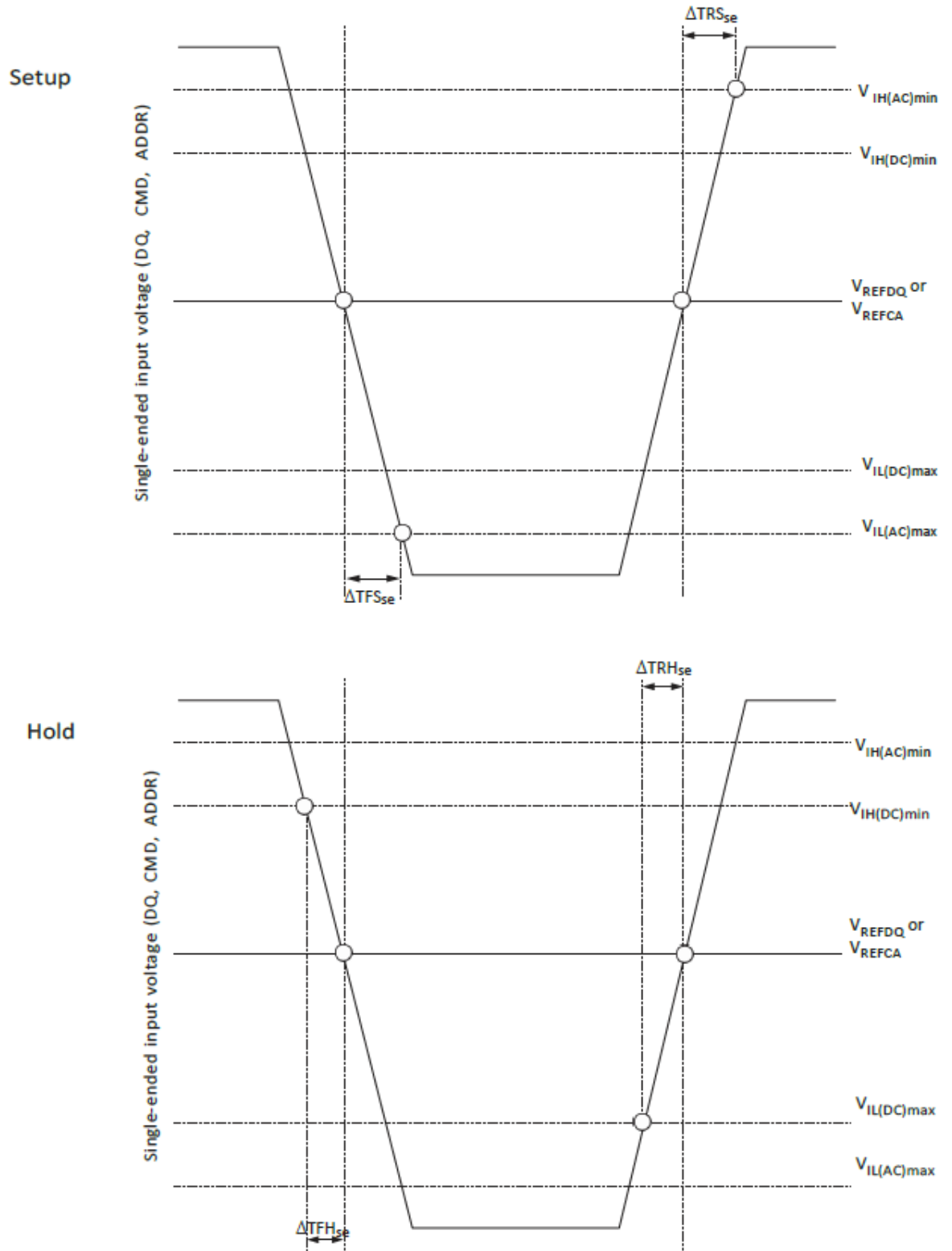

### DDR3L 1.35V Slew Rate Definitions for Differential Input Signals

Input slew rate for differential signals (CK, CKB and DQS, DQS#) are defined and measured. The nominal slew rate for a rising signal is defined as the slew rate between  $V_{IL,diff,max}$  and  $V_{IH,diff,min}$ . The nominal slew rate for a falling signal is defined as the slew rate between  $V_{IH,diff,min}$  and  $V_{IL,diff,max}$ .

#### DDR3L 1.35V Differential Input Slew Rate Definition

Differential Input Slew Rates (Linear Signals)		Measured		Calculation
Input	Edge	From	To	
CK and DQS reference	Rising	$V_{IL,diff,max}$	$V_{IH,diff,min}$	$\frac{V_{IH,diff,min} - V_{IL,diff,max}}{\Delta TR_{diff}}$
	Falling	$V_{IH,diff,min}$	$V_{IL,diff,max}$	$\frac{V_{IH,diff,min} - V_{IL,diff,max}}{\Delta TF_{diff}}$

#### DDR3L 1.35V Nominal Differential Input Slew Rate Definition for DQS, DQS# and CK, CKB

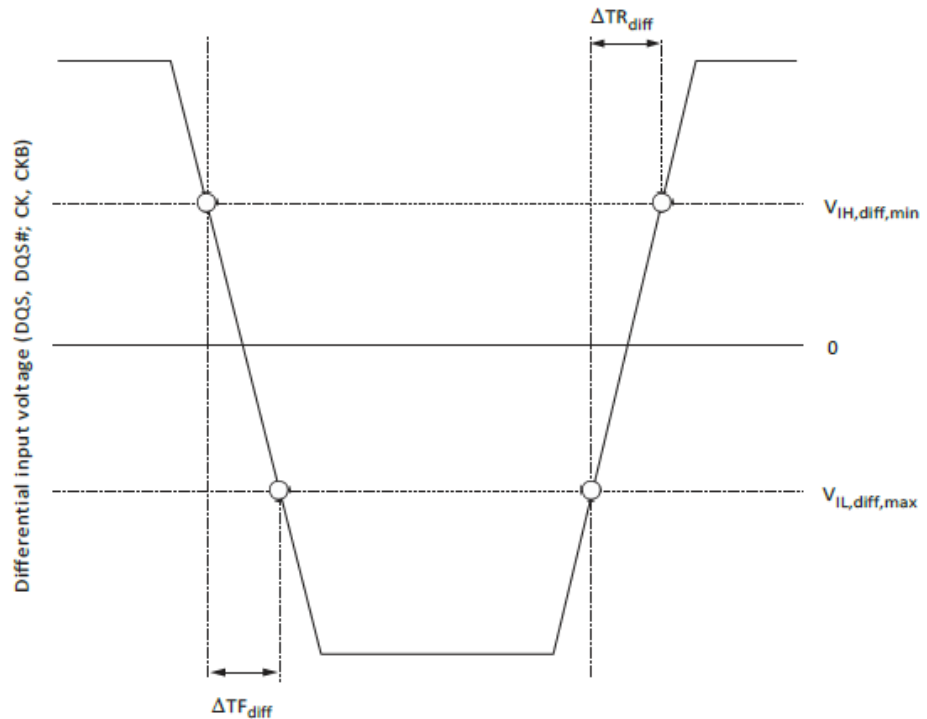

## 6. ODT Characteristics

The ODT effective resistance  $R_{TT}$  is defined by MR1[9,6, and 2]. ODT is applied to the DQ, DM, DQS, DQS#, balls (x8 devices only). The ODT target values and a functional representation are listed. The individual pull-up and pull-down resistors ( $R_{TT(PU)}$  and  $R_{TT(PD)}$ ) are defined as follows:

- $R_{TT(PU)} = (V_{DDQ} - V_{OUT}) / |I_{OUT}|$ , under the condition that  $R_{TT(PD)}$  is turned off
- $R_{TT(PD)} = (V_{OUT}) / |I_{OUT}|$ , under the condition that  $R_{TT(PU)}$  is turned off

### ODT Levels and I-V Characteristics

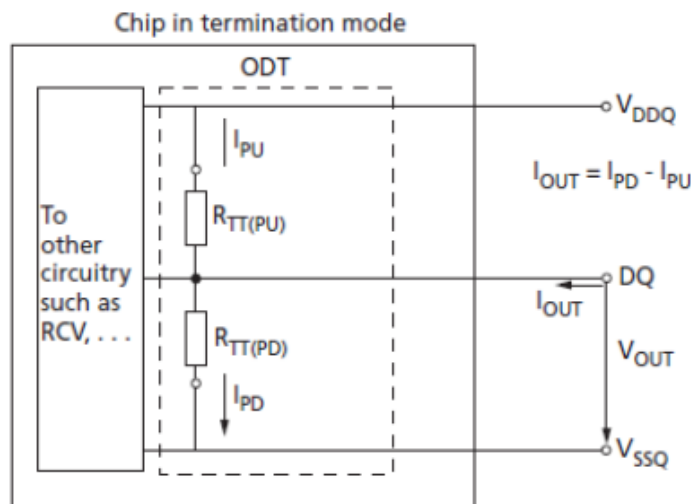

### On-Die Termination DC Electrical Characteristics

Parameter/Condition	Symbol	Min	Nom	Max	Unit	Notes
$R_{TT}$ effective impedance	$R_{TT(EFF)}$					1, 2
Deviation of VM with respect to $V_{DDQ}/2$	$\Delta VM$	-5		5	%	1, 2, 3

Notes: 1. Tolerance limits are applicable after proper ZQ calibration has been performed at a stable temperature and voltage ( $V_{DDQ} = V_{DD}$ ,  $V_{SSQ} = V_{SS}$ ). Refer to ODT Sensitivity if either the temperature or voltage changes after calibration.

2. Measurement definition for  $R_{TT}$ : Apply  $V_{IH(AC)}$  to pin under test and measure current  $I[V_{IH(AC)}]$ , then apply  $V_{IL(AC)}$  to pin under test and measure current  $I[V_{IL(AC)}]$ :

$$R_{TT} = \frac{V_{IH(AC)} - V_{IL(AC)}}{I(V_{IH(AC)}) - I(V_{IL(AC)})}$$

3. Measure voltage (VM) at the tested pin with no load:

$$\Delta VM = \frac{2 \times VM}{V_{DDQ}} - 1 \times 100$$

4. For IT and AT devices, the minimum values are derated by 6% when the device operates between  $-40^{\circ}\text{C}$  and  $0^{\circ}\text{C}$  ( $T_C$ ).





### 1.35V ODT Resistors

Provides an overview of the ODT DC electrical characteristics. The values provided are not specification requirements; however, they can be used as design guide lines to indicate what  $R_{TT}$  is targeted to provide:

- $R_{TT}$  120Ω is made up of  $R_{TT120(PD240)}$  and  $R_{TT120(PU240)}$
- $R_{TT}$  60Ω is made up of  $R_{TT60(PD120)}$  and  $R_{TT60(PU120)}$
- $R_{TT}$  40Ω is made up of  $R_{TT40(PD80)}$  and  $R_{TT40(PU80)}$
- $R_{TT}$  30Ω is made up of  $R_{TT30(PD60)}$  and  $R_{TT30(PU60)}$
- $R_{TT}$  20Ω is made up of  $R_{TT20(PD40)}$  and  $R_{TT20(PU40)}$

### 1.35V $R_{TT}$ Effective Impedance

MR1 [9, 6, 2]	$R_{TT}$	Resistor	$V_{OUT}$	Min	Nom	Max	Units		
0, 1, 0	120Ω	$R_{TT,120PD240}$	$0.2 \times V_{DDQ}$	0.6	1.0	1.15	RZQ/1		
			$0.5 \times V_{DDQ}$	0.9	1.0	1.15	RZQ/1		
			$0.8 \times V_{DDQ}$	0.9	1.0	1.45	RZQ/1		
		$R_{TT,120PU240}$	$0.2 \times V_{DDQ}$	0.9	1.0	1.45	RZQ/1		
			$0.5 \times V_{DDQ}$	0.9	1.0	1.15	RZQ/1		
			$0.8 \times V_{DDQ}$	0.6	1.0	1.15	RZQ/1		
				120Ω	$V_{IL(AC)}$ to $V_{IH(AC)}$	0.9	1.0	1.65	RZQ/2
		0, 0, 1	60Ω	$R_{TT,60PD120}$	$0.2 \times V_{DDQ}$	0.6	1.0	1.15	RZQ/2
					$0.5 \times V_{DDQ}$	0.9	1.0	1.15	RZQ/2
$0.8 \times V_{DDQ}$	0.9				1.0	1.45	RZQ/2		
$R_{TT,60PU120}$	$0.2 \times V_{DDQ}$			0.9	1.0	1.45	RZQ/2		
	$0.5 \times V_{DDQ}$			0.9	1.0	1.15	RZQ/2		
	$0.8 \times V_{DDQ}$			0.6	1.0	1.15	RZQ/2		
				60Ω	$V_{IL(AC)}$ to $V_{IH(AC)}$	0.9	1.0	1.65	RZQ/4
0, 1, 1	40Ω			$R_{TT,40PD80}$	$0.2 \times V_{DDQ}$	0.6	1.0	1.15	RZQ/3
					$0.5 \times V_{DDQ}$	0.9	1.0	1.15	RZQ/3
		$0.8 \times V_{DDQ}$	0.9		1.0	1.45	RZQ/3		
		$R_{TT,40PU80}$	$0.2 \times V_{DDQ}$	0.9	1.0	1.45	RZQ/3		
			$0.5 \times V_{DDQ}$	0.9	1.0	1.15	RZQ/3		
			$0.8 \times V_{DDQ}$	0.6	1.0	1.15	RZQ/3		
				40Ω	$V_{IL(AC)}$ to $V_{IH(AC)}$	0.9	1.0	1.65	RZQ/6
		1, 0, 1	30Ω	$R_{TT,30PD60}$	$0.2 \times V_{DDQ}$	0.6	1.0	1.15	RZQ/4
					$0.5 \times V_{DDQ}$	0.9	1.0	1.15	RZQ/4
$0.8 \times V_{DDQ}$	0.9				1.0	1.45	RZQ/4		
$R_{TT,30PU60}$	$0.2 \times V_{DDQ}$			0.9	1.0	1.45	RZQ/4		
	$0.5 \times V_{DDQ}$			0.9	1.0	1.15	RZQ/4		
	$0.8 \times V_{DDQ}$			0.6	1.0	1.15	RZQ/4		
				30Ω	$V_{IL(AC)}$ to $V_{IH(AC)}$	0.9	1.0	1.65	RZQ/8



### 1.35 V R<sub>TT</sub> Effective Impedance (Continued)

MR1 [9, 6, 2]	R <sub>TT</sub>	Resistor	V <sub>OUT</sub>	Min	Nom	Max	Units
1, 0, 0	20Ω	R <sub>TT,20PD40</sub>	0.2 × V <sub>DDQ</sub>	0.6	1.0	1.15	RZQ/6
			0.5 × V <sub>DDQ</sub>	0.9	1.0	1.15	RZQ/6
			0.8 × V <sub>DDQ</sub>	0.9	1.0	1.45	RZQ/6
		R <sub>TT,20PU40</sub>	0.2 × V <sub>DDQ</sub>	0.9	1.0	1.45	RZQ/6
			0.5 × V <sub>DDQ</sub>	0.9	1.0	1.15	RZQ/6
			0.8 × V <sub>DDQ</sub>	0.6	1.0	1.15	RZQ/6
		20Ω		V <sub>IL(AC)</sub> to V <sub>IH(AC)</sub>	0.9	1.0	1.65

### ODT Sensitivity

If either the temperature or voltage changes after I/O calibration, then the tolerance limits listed can be expected to widen according to list.

### ODT Sensitivity Definition

Symbol	Min	Max	Unit
R <sub>TT</sub>	0.9 - dR <sub>TTdT</sub> ×  DT  - dR <sub>TTdV</sub> ×  DV	1.6 + dR <sub>TTdT</sub> ×  DT  + dR <sub>TTdV</sub> ×  DV	RZQ/(2, 4, 6, 8, 12)

Note: 1. ΔT = T - T(@ calibration), ΔV = V<sub>DDQ</sub> - V<sub>DDQ</sub>(@ calibration) and V<sub>DD</sub> = V<sub>DDQ</sub>.

### ODT Temperature and Voltage Sensitivity

Change	Min	Max	Unit
dR <sub>TTdT</sub>	0	1.5	%/°C
dR <sub>TTdV</sub>	0	0.15	%/mV

Note: 1. ΔT = T - T(@ calibration), ΔV = V<sub>DDQ</sub> - V<sub>DDQ</sub>(@ calibration) and V<sub>DD</sub> = V<sub>DDQ</sub>.

### ODT Timing Definitions

ODT loading differs from that used in AC timing measurements. The reference load for ODT timings is shown. Two parameters define when ODT turns on or off synchronously, two define when ODT turns on or off asynchronously, and another defines when ODT turns on or off dynamically. Outline and provide definition and measurement references settings for each parameter.

ODT turn-on time begins when the output leaves High-Z and ODT resistance begins to turn on. ODT turn-off time begins when the output leaves Low-Z and ODT resistance begins to turn off.



ODT Timing Reference Load

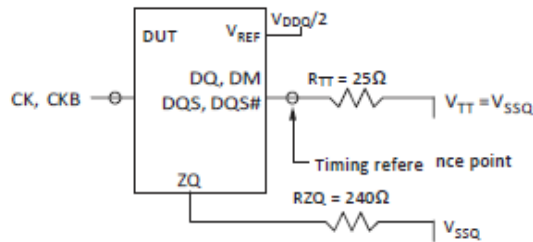

ODT Timing Definitions

Symbol	Begin Point Definition	End Point Definition
<sup>t</sup> AON	Rising edge of CK – CKB defined by the end point of ODTL <sub>on</sub>	Extrapolated point at V <sub>SSQ</sub>
<sup>t</sup> AOF	Rising edge of CK – CKB defined by the end point of ODTL <sub>off</sub>	Extrapolated point at V <sub>RTT,nom</sub>
<sup>t</sup> AONPD	Rising edge of CK – CKB with ODT first being registered HIGH	Extrapolated point at V <sub>SSQ</sub>
<sup>t</sup> AOFPD	Rising edge of CK – CKB with ODT first being registered LOW	Extrapolated point at V <sub>RTT,nom</sub>
<sup>t</sup> ADC	Rising edge of CK – CKB defined by the end point of ODTL <sub>cnw</sub> , ODTL <sub>cwn4</sub> , or ODTL <sub>cwn8</sub>	Extrapolated points at V <sub>RTT(WR)</sub> and V <sub>RTT,nom</sub>

DDR3L (1.35V) Reference Settings for ODT Timing Measurements

Measured Parameter	R <sub>TT,nom</sub> Setting	R <sub>TT(WR)</sub> Setting	V <sub>SW1</sub>	V <sub>SW2</sub>
<sup>t</sup> AON	RZQ/4 (60Ω)	N/A	50mV	100mV
	RZQ/12 (20Ω)	N/A	100mV	200mV
<sup>t</sup> AOF	RZQ/4 (60Ω)	N/A	50mV	100mV
	RZQ/12 (20Ω)	N/A	100mV	200mV
<sup>t</sup> AONPD	RZQ/4 (60Ω)	N/A	50mV	100mV
	RZQ/12 (20Ω)	N/A	100mV	200mV
<sup>t</sup> AOFPD	RZQ/4 (60Ω)	N/A	50mV	100mV
	RZQ/12 (20Ω)	N/A	100mV	200mV
<sup>t</sup> ADC	RZQ/12 (20Ω)	RZQ/2 (20Ω)	200mV	250mV



### $t_{AON}$ and $t_{AOF}$ Definitions

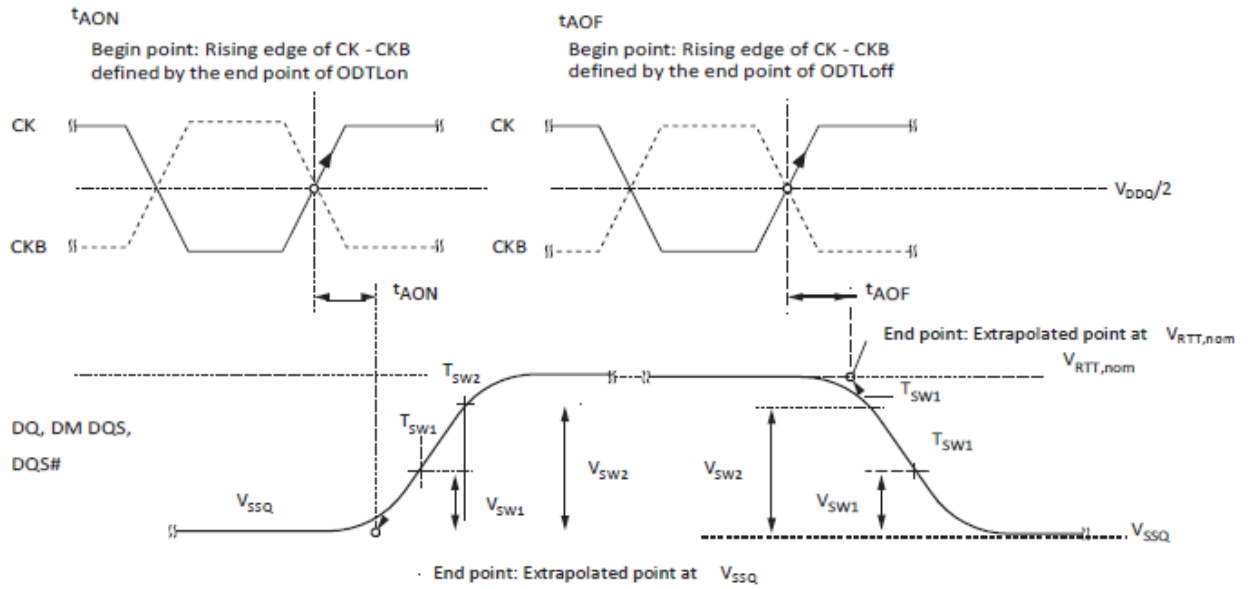

### $t_{AONPD}$ and $t_{AOFPD}$ Definitions

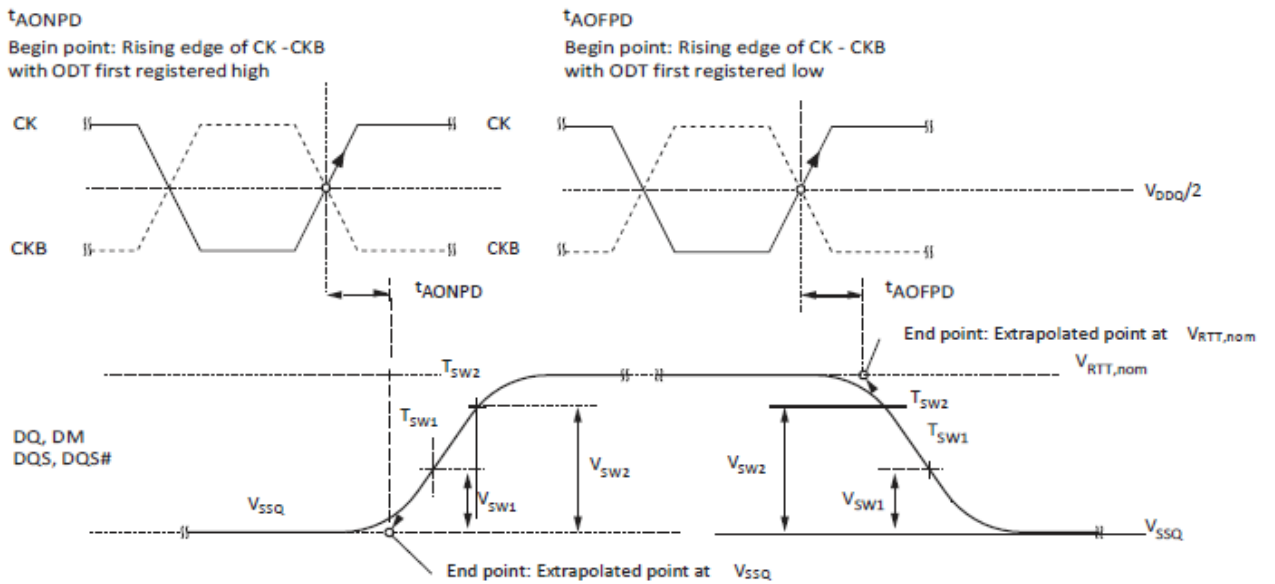

**<sup>t</sup>ADC Definition**

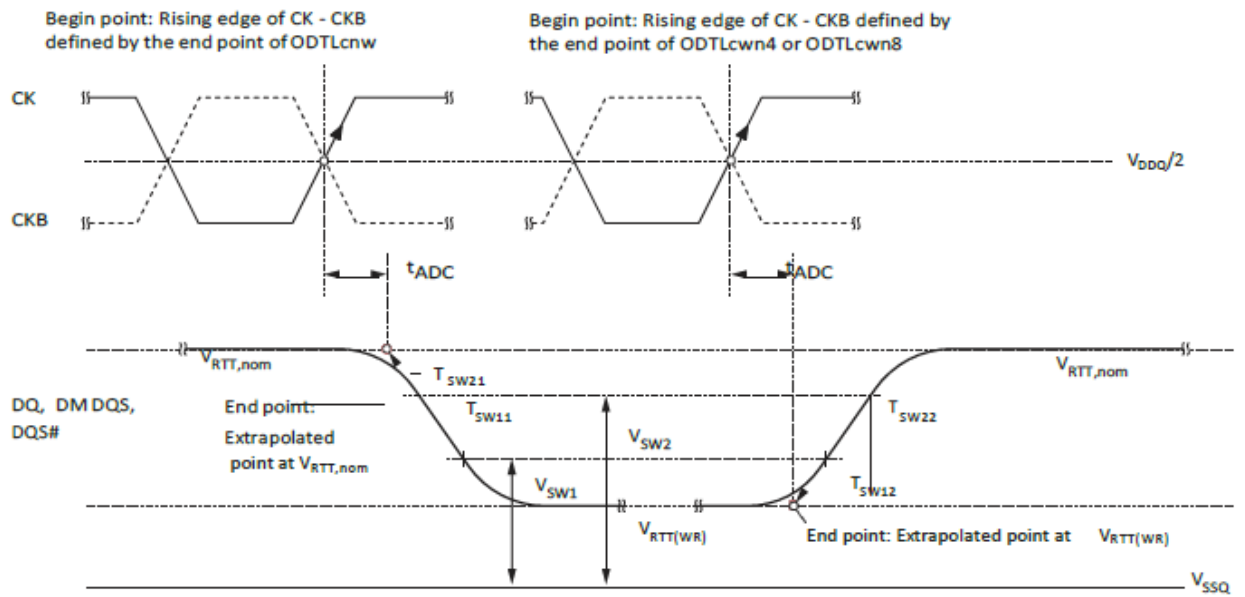

CONFIDENTIAL



## 7. Output Driver Impedance

The output driver impedance is selected by MR1[5,1] during initialization. The selected value is able to maintain the tight tolerances specified if proper ZQ calibration is performed. Output specifications refer to the default output driver unless specifically stated otherwise. A functional representation of the output buffer is shown below. The output driver impedance  $R_{ON}$  is defined by the value of the external reference resistor RZQ as follows:

- $R_{ON,x} = RZQ/y$  (with  $RZQ = 240\Omega \pm 1\%$ ;  $x = 34\Omega$  or  $40\Omega$  with  $y = 7$  or  $6$ , respectively)

The individual pull-up and pull-down resistors  $R_{ON(PU)}$  and  $R_{ON(PD)}$  are defined as follows:

- $R_{ON(PU)} = (V_{DDQ} - V_{OUT})/|I_{OUT}|$ , when  $R_{ON(PD)}$  is turned off
- $R_{ON(PD)} = V_{OUT}/|I_{OUT}|$ , when  $R_{ON(PU)}$  is turned off

### Output Driver

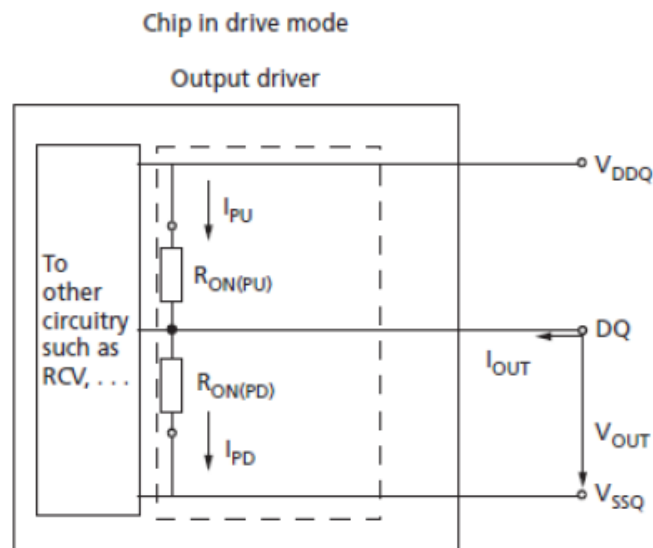

### 34 Ohm Output Driver Impedance

The 34Ω driver(MR1[5, 1] = 01) is the default driver. Unless otherwise stated, all timings and specifications listed herein apply to the 34Ω driver only. Its impedance  $R_{ON}$  is defined by the value of the external reference resistor RZQ as follows:  
 $R_{ON34} = RZQ/7$  (with nominal RZQ = 240Ω ±1%) and is actually 34.3Ω ±1%.

#### DDR3L 34 Ohm Driver Impedance Characteristics

MR1 [5, 1]	$R_{ON}$	Resistor	$V_{OUT}$	Min	Nom	Max	Units
0, 1	34.3Ω	$R_{ON,34PD}$	$0.2 \times V_{DDQ}$	0.6	1.0	1.15	RZQ/7
			$0.5 \times V_{DDQ}$	0.9	1.0	1.15	RZQ/7
			$0.8 \times V_{DDQ}$	0.9	1.0	1.45	RZQ/7
		$R_{ON,34PU}$	$0.2 \times V_{DDQ}$	0.9	1.0	1.45	RZQ/7
			$0.5 \times V_{DDQ}$	0.9	1.0	1.15	RZQ/7
			$0.8 \times V_{DDQ}$	0.6	1.0	1.15	RZQ/7
Pull-up/pull-down mismatch ( $MM_{PUPD}$ )			$V_{IL(AC)}$ to $V_{IH(AC)}$	-10	N/A	10	%

- Notes:
1. Tolerance limits assume RZQ of 240Ω ±1% and are applicable after proper ZQ calibration has been performed at a stable temperature and voltage:  $V_{DDQ} = V_{DD}$ ;  $V_{SSQ} = V_{SS}$ . Refer to DDR3L 34 Ohm Output Driver Sensitivity if either the temperature or the voltage changes after calibration.
  2. Measurement definition for mismatch between pull-up and pull-down ( $MM_{PUPD}$ ). Measure both  $R_{ON(PU)}$  and  $R_{ON(PD)}$  at  $0.5 \times V_{DDQ}$ :  

$$MM_{PUPD} = \frac{R_{ON(PU)} - R_{ON(PD)}}{R_{ON,nom}} \times 100$$
  3. For IT and AT (1Gb only) devices, the minimum values are derated by 6% when the device operates between -40°C and 0°C ( $T_C$ ).  
 A larger maximum limit will result in slightly lower minimum currents.



### DDR3L 34 Ohm Driver

The 34Ω driver's current range has been calculated and summarized  $V_{DD} = 1.35V$ ,  $V_{DD} = 1.45V$ ,  $V_{DD} = 1.283V$ . The individual pull-up and pull-down resistors  $R_{ON34(PD)}$  and  $R_{ON34(PU)}$  are defined as follows:

- $R_{ON34(PD)} = (V_{OUT})/|I_{OUT}|$ ;  $R_{ON34(PU)}$  is turned off
- $R_{ON34(PU)} = (V_{DDQ} - V_{OUT})/|I_{OUT}|$ ;  $R_{ON34(PD)}$  is turned off

### DDR3L 34 Ohm Driver Pull-Up and Pull-Down Impedance Calculations

$R_{ON}$				Min	Nom	Max	Unit
RZQ = 240Ω ±1%				237.6	240	242.4	Ω
RZQ/7 = (240Ω ±1%)/7				33.9	34.3	34.6	Ω
MR1[5,1]	$R_{ON}$	Resistor	$V_{OUT}$	Min	Nom	Max	Unit
0, 1	34.3Ω	$R_{ON34(PD)}$	0.2 × $V_{DDQ}$	20.4	34.3	38.1	Ω
			0.5 × $V_{DDQ}$	30.5	34.3	38.1	Ω
			0.8 × $V_{DDQ}$	30.5	34.3	48.5	Ω
		$R_{ON34(PU)}$	0.2 × $V_{DDQ}$	30.5	34.3	48.5	Ω
			0.5 × $V_{DDQ}$	30.5	34.3	38.1	Ω
			0.8 × $V_{DDQ}$	20.4	34.3	38.1	Ω

### DDR3L 34 Ohm Driver $I_{OH}/I_{OL}$ Characteristics: $V_{DD} = V_{DDQ} = DDR3L@1.35V$

MR1[5,1]	$R_{ON}$	Resistor	$V_{OUT}$	Max	Nom	Min	Unit
0, 1	34.3Ω	$R_{ON34(PD)}$	$I_{OL} @ 0.2 \times V_{DDQ}$	13.3	7.9	7.1	mA
			$I_{OL} @ 0.5 \times V_{DDQ}$	22.1	19.7	17.7	mA
			$I_{OL} @ 0.8 \times V_{DDQ}$	35.4	31.5	22.3	mA
		$R_{ON34(PU)}$	$I_{OH} @ 0.2 \times V_{DDQ}$	35.4	31.5	22.3	mA
			$I_{OH} @ 0.5 \times V_{DDQ}$	22.1	19.7	17.7	mA
			$I_{OH} @ 0.8 \times V_{DDQ}$	13.3	7.9	7.1	mA

### DDR3L 34 Ohm Driver $I_{OH}/I_{OL}$ Characteristics: $V_{DD} = V_{DDQ} = DDR3L@1.45V$

MR1[5,1]	$R_{ON}$	Resistor	$V_{OUT}$	Max	Nom	Min	Unit
0, 1	34.3Ω	$R_{ON34(PD)}$	$I_{OL} @ 0.2 \times V_{DDQ}$	14.2	8.5	7.6	mA
			$I_{OL} @ 0.5 \times V_{DDQ}$	23.7	21.1	19.0	mA
			$I_{OL} @ 0.8 \times V_{DDQ}$	38.0	33.8	23.9	mA
		$R_{ON34(PU)}$	$I_{OH} @ 0.2 \times V_{DDQ}$	38.0	33.8	23.9	mA
			$I_{OH} @ 0.5 \times V_{DDQ}$	23.7	21.1	19.0	mA
			$I_{OH} @ 0.8 \times V_{DDQ}$	14.2	8.5	7.6	mA





**DDR3L 34 Ohm Driver I<sub>OH</sub>/I<sub>OL</sub> Characteristics: V<sub>DD</sub> = V<sub>DDQ</sub> = DDR3L@1.283**

MR1[5,1]	R <sub>ON</sub>	Resistor	V <sub>OUT</sub>	Max	Nom	Min	Unit
0, 1	34.3Ω	R <sub>ON34(PD)</sub>	I <sub>OL</sub> @ 0.2 × V <sub>DDQ</sub>	12.6	7.5	6.7	mA
			I <sub>OL</sub> @ 0.5 × V <sub>DDQ</sub>	21.0	18.7	16.8	mA
			I <sub>OL</sub> @ 0.8 × V <sub>DDQ</sub>	33.6	29.9	21.2	mA
		R <sub>ON34(PU)</sub>	I <sub>OH</sub> @ 0.2 × V <sub>DDQ</sub>	33.6	29.9	21.2	mA
			I <sub>OH</sub> @ 0.5 × V <sub>DDQ</sub>	21.0	18.7	16.8	mA
			I <sub>OH</sub> @ 0.8 × V <sub>DDQ</sub>	12.6	7.5	6.7	mA

**DDR3L 34 Ohm Output Driver Sensitivity**

If either the temperature or the voltage changes after ZQ calibration, then the tolerance limits listed can be expected to widen according to list.

**DDR3L 34 Ohm Output Driver Sensitivity Definition**

Symbol	Min	Max	Unit
R <sub>ON(PD)</sub> @ 0.2 × V <sub>DDQ</sub>	0.6 - dR <sub>OND</sub> TL ×  ΔT  - dR <sub>OND</sub> VL ×  ΔV	1.1 + dR <sub>OND</sub> TL ×  ΔT  + dR <sub>OND</sub> VL ×  ΔV	RZQ/7
R <sub>ON(PD)</sub> @ 0.5 × V <sub>DDQ</sub>	0.9 - dR <sub>OND</sub> TM ×  ΔT  - dR <sub>OND</sub> VM ×  ΔV	1.1 + dR <sub>OND</sub> TM ×  ΔT  + dR <sub>OND</sub> VM ×  ΔV	RZQ/7
R <sub>ON(PD)</sub> @ 0.8 × V <sub>DDQ</sub>	0.9 - dR <sub>OND</sub> TH ×  ΔT  - dR <sub>OND</sub> VH ×  ΔV	1.4 + dR <sub>OND</sub> TH ×  ΔT  + dR <sub>OND</sub> VH ×  ΔV	RZQ/7
R <sub>ON(PU)</sub> @ 0.2 × V <sub>DDQ</sub>	0.9 - dR <sub>OND</sub> TL ×  ΔT  - dR <sub>OND</sub> VL ×  ΔV	1.4 + dR <sub>OND</sub> TL ×  ΔT  + dR <sub>OND</sub> VL ×  ΔV	RZQ/7
R <sub>ON(PU)</sub> @ 0.5 × V <sub>DDQ</sub>	0.9 - dR <sub>OND</sub> TM ×  ΔT  - dR <sub>OND</sub> VM ×  ΔV	1.1 + dR <sub>OND</sub> TM ×  ΔT  + dR <sub>OND</sub> VM ×  ΔV	RZQ/7
R <sub>ON(PU)</sub> @ 0.8 × V <sub>DDQ</sub>	0.6 - dR <sub>OND</sub> TH ×  ΔT  - dR <sub>OND</sub> VH ×  ΔV	1.1 + dR <sub>OND</sub> TH ×  ΔT  + dR <sub>OND</sub> VH ×  ΔV	RZQ/7

Note: 1. ΔT = T - T<sub>(@CALIBRATION)</sub>; ΔV = V<sub>DDQ</sub> - V<sub>DDQ(@CALIBRATION)</sub>; and V<sub>DD</sub> = V<sub>DDQ</sub>.

**DDR3L 34 Ohm Output Driver Voltage and Temperature Sensitivity**

Change	Min	Max	Unit
dR <sub>OND</sub> TM	0	1.5	%/°C
dR <sub>OND</sub> VM	0	0.13	%/mV
dR <sub>OND</sub> TL	0	1.5	%/°C
dR <sub>OND</sub> VL	0	0.13	%/mV
dR <sub>OND</sub> TH	0	1.5	%/°C
dR <sub>OND</sub> VH	0	0.13	%/mV



## DDR3L Alternative 40 Ohm Driver

### DDR3L 40 Ohm Driver Impedance Characteristics

MR1 [5, 1]	R <sub>ON</sub>	Resistor	V <sub>OUT</sub>	Min	Nom	Max	Units
0, 0	40Ω	R <sub>ON,40PD</sub>	0.2 × V <sub>DDQ</sub>	0.6	1.0	1.15	RZQ/6
			0.5 × V <sub>DDQ</sub>	0.9	1.0	1.15	RZQ/6
			0.8 × V <sub>DDQ</sub>	0.9	1.0	1.45	RZQ/6
		R <sub>ON,40PU</sub>	0.2 × V <sub>DDQ</sub>	0.9	1.0	1.45	RZQ/6
			0.5 × V <sub>DDQ</sub>	0.9	1.0	1.15	RZQ/6
			0.8 × V <sub>DDQ</sub>	0.6	1.0	1.15	RZQ/6
Pull-up/pull-down mismatch (MM <sub>PUPD</sub> )			V <sub>IL(AC)</sub> to V <sub>IH(AC)</sub>	-10	N/A	10	%

- Notes: 1. Tolerance limits assume RZQ of 240Ω ±1% and are applicable after proper ZQ calibration has been performed at a stable temperature and voltage (V<sub>DDQ</sub> = V<sub>DD</sub>; V<sub>SSQ</sub> = V<sub>SS</sub>). Refer to DDR3L 40 Ohm Output Driver Sensitivity if either the temperature or the voltage changes after calibration.
2. Measurement definition for mismatch between pull-up and pull-down (MM<sub>PUPD</sub>). Measure both R<sub>ON(PU)</sub> and R<sub>ON(PD)</sub> at 0.5 × V<sub>DDQ</sub>:
- $$MM_{PUPD} = \frac{R_{ON(PU)} - R_{ON(PD)}}{R_{ON,nom}} \times 100$$
3. For IT and AT (1Gb only) devices, the minimum values are derated by 6% when the device operates between -40°C and 0°C (T<sub>C</sub>). A larger maximum limit will result in slightly lower minimum currents.

### DDR3L 40 Ohm Output Driver Sensitivity

If either the temperature or the voltage changes after I/O calibration, then the tolerance limits listed can be expected to widen according to t.

#### DDR3L 40 Ohm Output Driver Sensitivity Definition

Symbol	Min	Max	Unit
R <sub>ON(PD)</sub> @ 0.2 × V <sub>DDQ</sub>	0.6 - dR <sub>ONdTL</sub> ×  ΔT  - dR <sub>ONdVL</sub> ×  ΔV	1.1 + dR <sub>ONdTL</sub> ×  ΔT  + dR <sub>ONdVL</sub> ×  ΔV	RZQ/6
R <sub>ON(PD)</sub> @ 0.5 × V <sub>DDQ</sub>	0.9 - dR <sub>ONdTM</sub> ×  ΔT  - dR <sub>ONdVM</sub> ×  ΔV	1.1 + dR <sub>ONdTM</sub> ×  ΔT  + dR <sub>ONdVM</sub> ×  ΔV	RZQ/6
R <sub>ON(PD)</sub> @ 0.8 × V <sub>DDQ</sub>	0.9 - dR <sub>ONdTH</sub> ×  ΔT  - dR <sub>ONdVH</sub> ×  ΔV	1.4 + dR <sub>ONdTH</sub> ×  ΔT  + dR <sub>ONdVH</sub> ×  ΔV	RZQ/6
R <sub>ON(PU)</sub> @ 0.2 × V <sub>DDQ</sub>	0.9 - dR <sub>ONdTL</sub> ×  ΔT  - dR <sub>ONdVL</sub> ×  ΔV	1.4 + dR <sub>ONdTL</sub> ×  ΔT  + dR <sub>ONdVL</sub> ×  ΔV	RZQ/6
R <sub>ON(PU)</sub> @ 0.5 × V <sub>DDQ</sub>	0.9 - dR <sub>ONdTM</sub> ×  ΔT  - dR <sub>ONdVM</sub> ×  ΔV	1.1 + dR <sub>ONdTM</sub> ×  ΔT  + dR <sub>ONdVM</sub> ×  ΔV	RZQ/6
R <sub>ON(PU)</sub> @ 0.8 × V <sub>DDQ</sub>	0.6 - dR <sub>ONdTH</sub> ×  ΔT  - dR <sub>ONdVH</sub> ×  ΔV	1.1 + dR <sub>ONdTH</sub> ×  ΔT  + dR <sub>ONdVH</sub> ×  ΔV	RZQ/6

Note: 1. ΔT = T - T<sub>(@CALIBRATION)</sub>; ΔV = V<sub>DDQ</sub> - V<sub>DDQ(@CALIBRATION)</sub>; and V<sub>DD</sub> = V<sub>DDQ</sub>.



**40 Ohm Output Driver Voltage and Temperature Sensitivity**

Change	Min	Max	Unit
dR <sub>OND</sub> TM	0	1.5	%/°C
dR <sub>OND</sub> VM	0	0.15	%/mV
dR <sub>OND</sub> TL	0	1.5	%/°C
dR <sub>OND</sub> VL	0	0.15	%/mV
dR <sub>OND</sub> TH	0	1.5	%/°C
dR <sub>OND</sub> VH	0	0.15	%/mV

CONFIDENTIAL



## 8. Output Characteristics and Operating Conditions

### DDR3L Single-Ended Output Driver Characteristics

All voltages are referenced to  $V_{SS}$

Parameter/Condition	Symbol	Min	Max	Unit	Notes
Output leakage current: DQ are disabled ; $0V \leq V_{OUT} \leq V_{DDQ}$ ; ODT is disabled ; ODT is HIGH	$I_{OZ}$	-5	5	$\mu A$	1
Output slew rate : Single-ended ; For rising and falling edges , measure between $V_{OL(AC)} = V_{REF} - 0.09 \times V_{DDQ}$ and $V_{OH(AC)} = V_{REF} + 0.09 \times V_{DDQ}$	$SRQ_{se}$	1.75	6	V/ns	1, 2, 3, 4
Single-ended DC high-level output voltage	$V_{OH(DC)}$	$0.8 \times V_{DDQ}$		V	1, 2, 5
Single-ended DC mid-point level output voltage	$V_{OM(DC)}$	$0.5 \times V_{DDQ}$		V	1, 2, 5
Single-ended DC low-level output voltage	$V_{OL(DC)}$	$0.2 \times V_{DDQ}$		V	1, 2, 5
Single-ended AC high-level output voltage	$V_{OH(AC)}$	$V_{TT} + 0.1 \times V_{DDQ}$		V	1, 2, 3, 6
Single-ended AC low-level output voltage	$V_{OL(AC)}$	$V_{TT} - 0.1 \times V_{DDQ}$		V	1, 2, 3, 6
Delta $R_{ON}$ between pull-up and pull-down for DQ/DQS	$MM_{PUPD}$	-10	10	%	1, 7
Test load for AC timing and output slew rates	Output to $V_{TT}$ ( $V_{DDQ}/2$ ) via $25\Omega$ resistor				3

- Notes:
1. RZQ of  $240\Omega \pm 1\%$  with RZQ/7 enabled (default  $34\Omega$  driver) and is applicable after proper ZQ calibration has been performed at a stable temperature and voltage ( $V_{DDQ} = V_{DD}$ ;  $V_{SSQ} = V_{SS}$ ).
  2.  $V_{TT} = V_{DDQ}/2$ .
  3. The test load configuration.
  4. The 6 V/ns maximum is applicable for a single DQ signal when it is switching either from HIGH to LOW or LOW to HIGH while the remaining DQ signals in the same byte lane are either all static or all switching in the opposite direction. For all other DQ signal switching combinations, the maximum limit of 6 V/ns is reduced to 5 V/ns.
  5. LV curve linearity. Do not use AC test load.
  6. See Slew Rate Definitions for Single-Ended Output Signals for output slewrate.
  7. Additional information.
  8. An example of a single-ended output signal.



DQ Output Signal

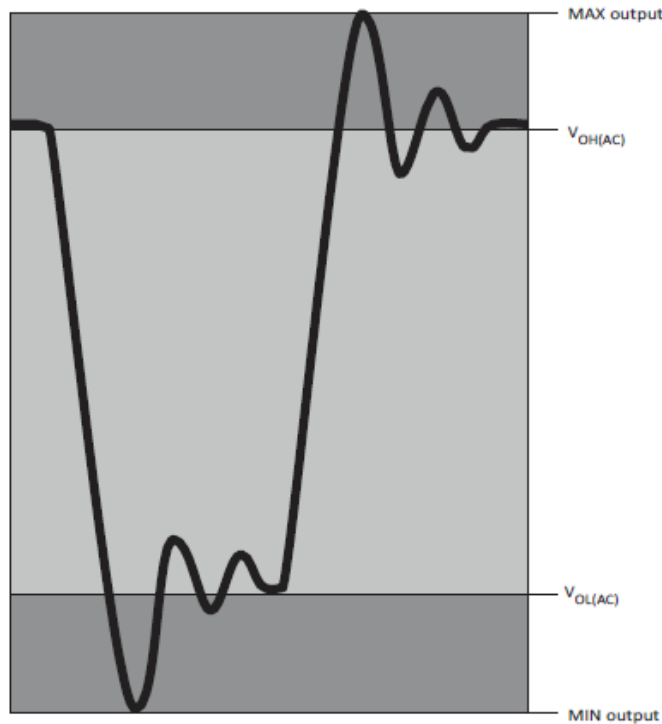

DDR3L Differential Output Driver Characteristics

All voltages are referenced to  $V_{SS}$

Parameter/Condition	Symbol	Min	Max	Unit	Notes
Output leakage current: DQ are disabled; $0V \leq V_{OUT} \leq V_{DDQ}$ ; ODT is disabled; ODT is HIGH	$I_{OZ}$	-5	5	$\mu A$	1
DDR3L Output slew rate: Differential; For rising and falling edges, measure between $V_{OL,diff(AC)} = -0.18 \times V_{DDQ}$ and $V_{OH,diff(AC)} = 0.18 \times V_{DDQ}$	$SRQ_{diff}$	3.5	12	V/ns	1
Differential high-level output voltage	$V_{OH,diff(AC)}$	$+0.2 \times V_{DDQ}$		V	1, 4
Differential low-level output voltage	$V_{OL,diff(AC)}$	$-0.2 \times V_{DDQ}$		V	1, 4
Delta Ron between pull-up and pull-down for DQ/DQS	$MM_{PUPD}$	-10	10	%	1, 5
Test load for AC timing and output slew rates	Output to $V_{TT}$ ( $V_{DDQ}/2$ ) via 25 $\Omega$ resistor				3

- Notes:
1. RZQ of 240 $\Omega$   $\pm$ 1% with RZQ/7 enabled (default 34 $\Omega$  driver) and is applicable after proper ZQ calibration has been performed at a stable temperature and voltage ( $V_{DDQ} = V_{DD}$ ;  $V_{SSQ} = V_{SS}$ ).
  2.  $V_{REF} = V_{DDQ}/2$ ; slew rate @ 5 V/ns, interpolate for faster slew rate.
  3. The test load configuration.
  4. The output slew rate.
  5. Additional information.
  6. An example of a differential output signal.



**DDR3L Differential Output Driver Characteristics  $V_{OX(AC)}$**

All voltages are referenced to  $V_{SS}$

Parameter/ Condition	Symbol		DDR3L-1600/1866/2133 DQS/DQS# Differential Slew Rate								Unit	
			3.5V/ns	4V/ns	5V/ns	6V/ns	7V/ns	8V/ns	9V/ns	10V/ns		12V/ns
Output differential crosspoint voltage	$V_{OX(AC)}$	Max	90	105	135	155	180	205	205	205	205	mV
		Min	-90	-105	-135	-155	-180	-205	-205	-205	-205	mV

- Notes:
1. RZQ of  $240\Omega \pm 1\%$  with RZQ/7 enabled (default  $34\Omega$  driver) and is applicable after proper ZQ calibration has been performed at a stable temperature and voltage ( $V_{DDQ} = V_{DD}$ ;  $V_{SSQ} = V_{SS}$ ).
  2. The test load configuration.
  3. An example of a differential output signal.
  4. For a differential slew rate between the list values, the  $V_{OX(AC)}$  value may be obtained by linear interpolation.

**Differential Output Signal**

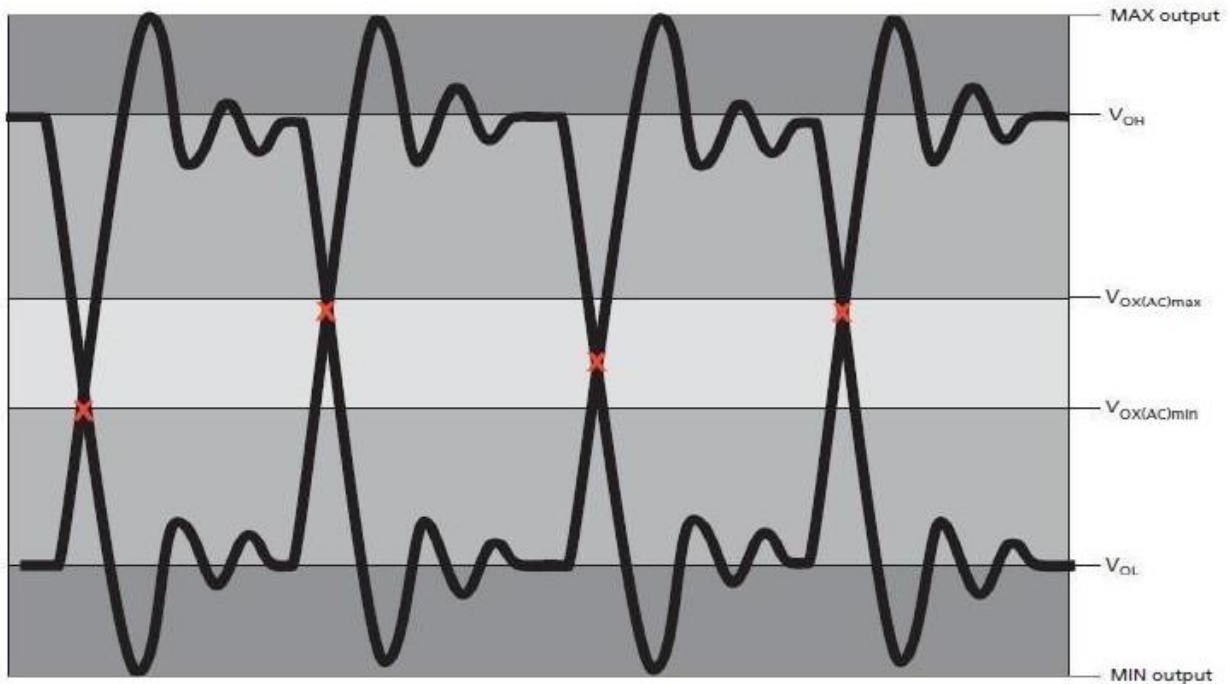

### Reference Output Load

Represents the effective reference load of 25Ω used in defining the relevant device AC timing parameters (except ODT reference timing) as well as the output slew rate measurements. It is not intended to be a precise representation of a particular system environment or a depiction of the actual load presented by a production tester. System designers should use IBIS or other simulation tools to correlate the timing reference load to a system environment.

### Reference Output Load for AC Timing and Output Slew Rate

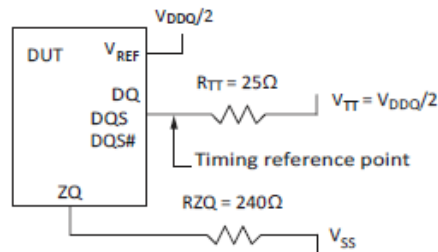

### Slew Rate Definitions for Single-Ended Output Signals

The single-ended output driver is summarized. With the reference load for timing measurements, the output slew rate for falling and rising edges is defined and measured between VOL(AC) and VOH(AC) for single-ended signals.

#### Single-Ended Output Slew Rate Definition

Single-Ended Output Slew Rates (Linear Signals)		Measured		Calculation
Output	Edge	From	To	
DQ	Rising	V <sub>OL(AC)</sub>	V <sub>OH(AC)</sub>	$\frac{V_{OH(AC)} - V_{OL(AC)}}{\Delta TR_{se}}$
	Falling	V <sub>OH(AC)</sub>	V <sub>OL(AC)</sub>	$\frac{V_{OH(AC)} - V_{OL(AC)}}{\Delta TF_{se}}$



### Nominal Slew Rate Definition for Single-Ended Output Signals

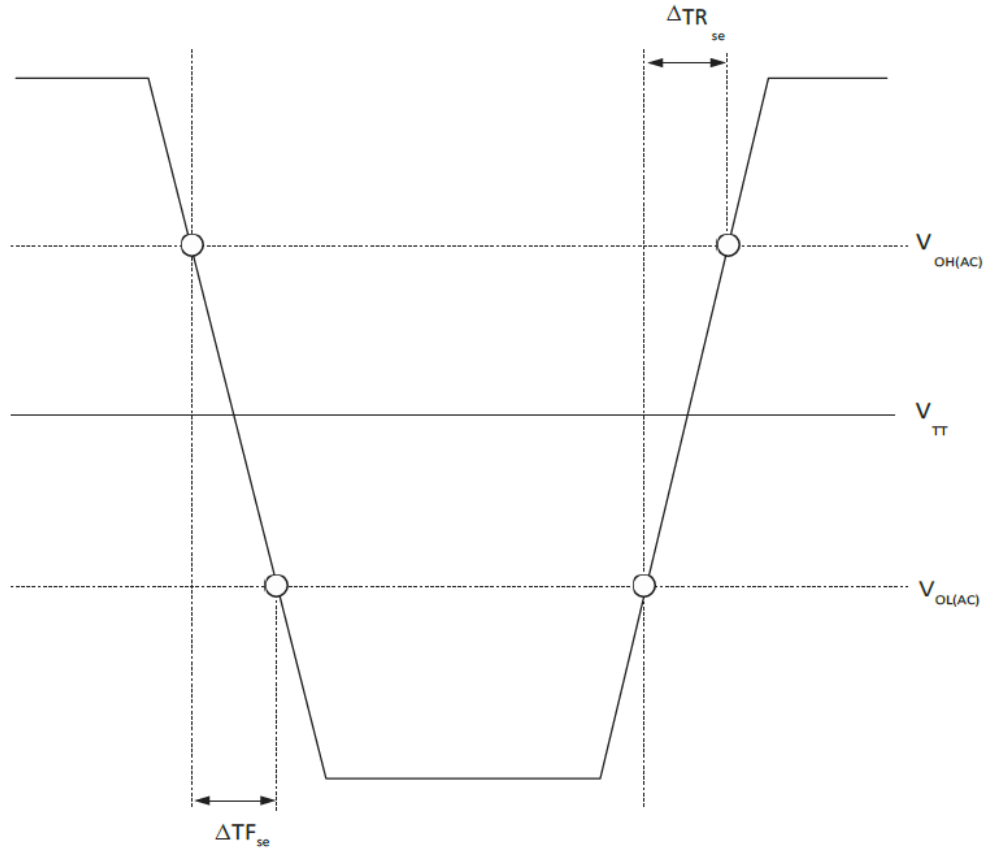



### Slew Rate Definitions for Differential Output Signals

The differential output driver is summarized. With the reference load for timing measurements, the output slew rate for falling and rising edges is defined and measured between  $V_{OL(AC)}$  and  $V_{OH(AC)}$  for differential signals.

#### Differential Output Slew Rate Definition

Differential Output Slew Rates (Linear Signals)		Measured		Calculation
Output	Edge	From	To	
DQS, DQS#	Rising	$V_{OL,diff(AC)}$	$V_{OH,diff(AC)}$	$\frac{V_{OH,diff(AC)} - V_{OL,diff(AC)}}{\Delta TR_{diff}}$
	Falling	$V_{OH,diff(AC)}$	$V_{OL,diff(AC)}$	$\frac{V_{OH,diff(AC)} - V_{OL,diff(AC)}}{\Delta TF_{diff}}$

#### Nominal Differential Output Slew Rate Definition for DQS, DQS#

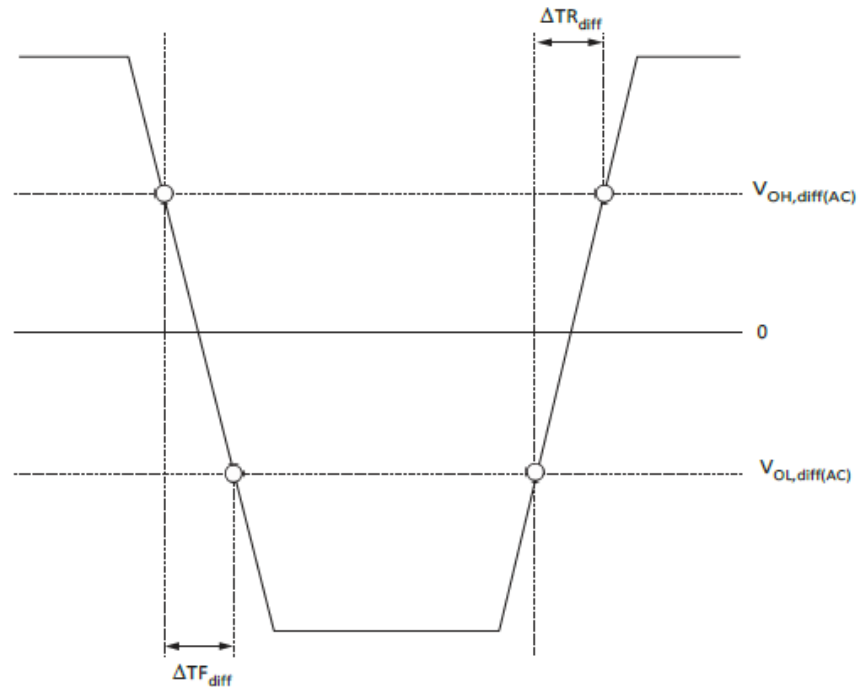

## 9. Speed Bin Tables

### DDR3L-1600 Speed Bins

DDR3L-1600 Speed Bin		-125 <sup>1</sup>		Unit	Notes	
CL- <sup>t</sup> RCD- <sup>t</sup> RP		11-11-11				
Parameter	Symbol	Min	Max			
Internal READ command to first data	<sup>t</sup> AA	13.75	–	ns		
ACTIVATE to internal READ or WRITE delay time	<sup>t</sup> RCD	13.75	–	ns		
PRECHARGE command period	<sup>t</sup> RP	13.75	–	ns		
ACTIVATE-to-ACTIVATE or REFRESH command period	<sup>t</sup> RC	48.75	–	ns		
ACTIVATE-to-PRECHARGE command period	<sup>t</sup> RAS	35	9 x <sup>t</sup> REFI	ns	2	
CL = 5	CWL = 5	<sup>t</sup> CK (AVG)	3.0	3.3	ns	3
	CWL = 6, 7, 8	<sup>t</sup> CK (AVG)	Reserved		ns	4
CL = 6	CWL = 5	<sup>t</sup> CK (AVG)	2.5	3.3	ns	3
	CWL = 6	<sup>t</sup> CK (AVG)	Reserved		ns	4
	CWL = 7, 8	<sup>t</sup> CK (AVG)	Reserved		ns	4
CL = 7	CWL = 5	<sup>t</sup> CK (AVG)	Reserved		ns	4
	CWL = 6	<sup>t</sup> CK (AVG)	1.875	<2.5	ns	3
	CWL = 7	<sup>t</sup> CK (AVG)	Reserved		ns	4
	CWL = 8	<sup>t</sup> CK (AVG)	Reserved		ns	4
CL = 8	CWL = 5	<sup>t</sup> CK (AVG)	Reserved		ns	4
	CWL = 6	<sup>t</sup> CK (AVG)	1.875	<2.5	ns	3
	CWL = 7	<sup>t</sup> CK (AVG)	Reserved		ns	4
	CWL = 8	<sup>t</sup> CK (AVG)	Reserved		ns	4
CL = 9	CWL = 5, 6	<sup>t</sup> CK (AVG)	Reserved		ns	4
	CWL = 7	<sup>t</sup> CK (AVG)	1.5	<1.875	ns	3
	CWL = 8	<sup>t</sup> CK (AVG)	Reserved		ns	4
CL = 10	CWL = 5, 6	<sup>t</sup> CK (AVG)	Reserved		ns	4
	CWL = 7	<sup>t</sup> CK (AVG)	1.5	<1.875	ns	3
	CWL = 8	<sup>t</sup> CK (AVG)	Reserved		ns	4
CL = 11	CWL = 5, 6, 7	<sup>t</sup> CK (AVG)	Reserved		ns	4
	CWL = 8	<sup>t</sup> CK (AVG)	1.25	<1.5	ns	3
Supported CL settings		5, 6, 7, 8, 9, 10, 11		CK		
Supported CWL settings		5, 6, 7, 8		CK		

Notes: 1. The -125 speed grade is backward compatible with 1333, CL = 9 (-15E) and 1066, CL = 7 (-187E).



DDR3L-1866 Speed Bins

DDR3L-1866 Speed Bin		-107 <sup>1</sup>		Unit	Notes
CL- <sup>t</sup> RCD- <sup>t</sup> RP		13-13-13			
Parameter	Symbol	Min	Max		
Internal READ command to first data	<sup>t</sup> AA	13.91	20		
ACTIVATE to internal READ or WRITE delay time	<sup>t</sup> RCD	13.91	–	ns	
PRECHARGE command period	<sup>t</sup> RP	13.91	–	ns	
ACTIVATE-to-ACTIVATE or REFRESH command period	<sup>t</sup> RC	47.91	–	ns	
ACTIVATE-to-PRECHARGE command period	<sup>t</sup> RAS	34	9 x <sup>t</sup> REFI	ns	2
CL = 5	CWL = 5	<sup>t</sup> CK (AVG)	3.0      3.3	ns	3
	CWL = 6, 7, 8, 9	<sup>t</sup> CK (AVG)	Reserved	ns	4
CL = 6	CWL = 5	<sup>t</sup> CK (AVG)	2.5      3.3	ns	3
	CWL = 6, 7, 8, 9	<sup>t</sup> CK (AVG)	Reserved	ns	4
CL = 7	CWL = 5, 7, 8, 9	<sup>t</sup> CK (AVG)	Reserved	ns	4
	CWL = 6	<sup>t</sup> CK (AVG)	1.875      <2.5	ns	3
CL = 8	CWL = 5, 8, 9	<sup>t</sup> CK (AVG)	Reserved	ns	4
	CWL = 6	<sup>t</sup> CK (AVG)	1.875      <2.5	ns	3
	CWL = 7	<sup>t</sup> CK (AVG)	Reserved	ns	4
CL = 9	CWL = 5, 6, 8, 9	<sup>t</sup> CK (AVG)	Reserved	ns	4
	CWL = 7	<sup>t</sup> CK (AVG)	1.5      <1.875	ns	3
CL = 10	CWL = 5, 6, 9	<sup>t</sup> CK (AVG)	Reserved	ns	4
	CWL = 7	<sup>t</sup> CK (AVG)	1.5      <1.875	ns	3
	CWL = 8	<sup>t</sup> CK (AVG)	Reserved	ns	4
CL = 11	CWL = 5, 6, 7	<sup>t</sup> CK (AVG)	Reserved	ns	4
	CWL = 8	<sup>t</sup> CK (AVG)	1.25      <1.5	ns	3
	CWL = 9	<sup>t</sup> CK (AVG)	Reserved	ns	4
CL = 12	CWL = 5, 6, 7, 8	<sup>t</sup> CK (AVG)	Reserved	ns	4
	CWL = 9	<sup>t</sup> CK (AVG)	Reserved	ns	4
CL = 13	CWL = 5, 6, 7, 8	<sup>t</sup> CK (AVG)	Reserved	ns	4
	CWL = 9	<sup>t</sup> CK (AVG)	1.07      <1.25	ns	3
Supported CL settings		5, 6, 7, 8, 9, 10, 11, 13		CK	
Supported CWL settings		5, 6, 7, 8, 9		CK	

Notes: 1. The -107 speed grade is backward compatible with 1600, CL = 11 (-125) , 1333, CL= 9 (- 15E) and 1066, CL = 7 (-187E).



DDR3L-2133 Speed Bin		-093 <sup>1</sup>		Unit	Notes	
CL- <sup>t</sup> RCD- <sup>t</sup> RP		14-14-14				
Parameter	Symbol	Min	Max			
Internal READ command to first data	<sup>t</sup> AA	13.09	20			
ACTIVATE to internal READ or WRITE delay time	<sup>t</sup> RCD	13.09	–	ns		
PRECHARGE command period	<sup>t</sup> RP	13.09	–	ns		
ACTIVATE-to-ACTIVATE or REFRESH command period	<sup>t</sup> RC	46.09	–	ns		
ACTIVATE-to-PRECHARGE command period	<sup>t</sup> RAS	33	9 x <sup>t</sup> REFI	ns	2	
CL = 5	CWL = 5	<sup>t</sup> CK (AVG)	3.0	3.3	ns	3
	CWL = 6, 7, 8, 9	<sup>t</sup> CK (AVG)	Reserved		ns	4
CL = 6	CWL = 5	<sup>t</sup> CK (AVG)	2.5	3.3	ns	3
	CWL = 6, 7, 8, 9	<sup>t</sup> CK (AVG)	Reserved		ns	4
CL = 7	CWL = 5, 7, 8, 9	<sup>t</sup> CK (AVG)	Reserved		ns	4
	CWL = 6	<sup>t</sup> CK (AVG)	1.875	<2.5	ns	3
CL = 8	CWL = 5, 8, 9	<sup>t</sup> CK (AVG)	Reserved		ns	4
	CWL = 6	<sup>t</sup> CK (AVG)	1.875	<2.5	ns	3
	CWL = 7	<sup>t</sup> CK (AVG)	Reserved		ns	4
CL = 9	CWL = 5, 6, 8, 9	<sup>t</sup> CK (AVG)	Reserved		ns	4
	CWL = 7	<sup>t</sup> CK (AVG)	1.5	<1.875	ns	3
CL = 10	CWL = 5, 6, 9	<sup>t</sup> CK (AVG)	Reserved		ns	4
	CWL = 7	<sup>t</sup> CK (AVG)	1.5	<1.875	ns	3
	CWL = 8	<sup>t</sup> CK (AVG)	Reserved		ns	4
CL = 11	CWL = 5, 6, 7	<sup>t</sup> CK (AVG)	Reserved		ns	4
	CWL = 8	<sup>t</sup> CK (AVG)	1.25	<1.5	ns	3
	CWL = 9	<sup>t</sup> CK (AVG)	Reserved		ns	4
CL = 12	CWL = 5, 6, 7, 8	<sup>t</sup> CK (AVG)	Reserved		ns	4
	CWL = 9	<sup>t</sup> CK (AVG)	Reserved		ns	4
CL = 13	CWL = 5, 6, 7, 8	<sup>t</sup> CK (AVG)	Reserved		ns	4
	CWL = 9	<sup>t</sup> CK (AVG)	1.07	<1.25	ns	3
CL = 14	CWL = 5, 6, 7, 8, 9	<sup>t</sup> CK (AVG)	Reserved	Reserved	ns	4
	CWL = 10	<sup>t</sup> CK (AVG)	0.938	<1.07	ns	3
Supported CL settings		5, 6, 7, 8, 9, 10, 11, 13, 14		CK		
Supported CWL settings		5, 6, 7, 8, 9		CK		

- Notes:
1. The -093 speed grade is backward compatible with 1866, CL = 13 (-107) , 1600, CL = 11 (-125), 1333, CL = 9 (-15E) and 1066, CL = 7 (-187E).
  2. <sup>t</sup>REFI depends on T<sub>OPER</sub>.
  3. The CL and CWL settings result in <sup>t</sup>CK requirements. When making a selection of <sup>t</sup>CK, both CL and CWL requirement settings need to be fulfilled.
  4. Reserved settings are not allowed.



## 10. Electrical Characteristics and AC Operating Conditions

### Electrical Characteristics and AC Operating Conditions

Notes 1–8 apply to the entire table

Parameter	Symbol	DDR3L-1600		Unit	Notes	
		Min	Max			
<b>Clock Timing</b>						
Clock period average: DLL disable mode	$T_c \leq 85^\circ\text{C}$	$t_{CK}$ (DLL_DIS)	8	7800	ns	9, 42
	$T_c = >85^\circ\text{C to } 95^\circ\text{C}$		8	3900	ns	42
Clock period average: DLL enable mode		$t_{CK}$ (AVG)			ns	10, 11
High pulse width average		$t_{CH}$ (AVG)	0.47	0.53	CK	12
Low pulse width average		$t_{CL}$ (AVG)	0.47	0.53	CK	12
Clock period jitter	DLL locked	$t_{JITper}$	-70	70	ps	13
	DLL locking	$t_{JITper,lck}$	-60	60	ps	13
Clock absolute period		$t_{CK}$ (ABS)	MIN = $t_{CK}$ (AVG) MIN + $t_{JITper}$ MIN; MAX = $t_{CK}$ (AVG) MAX + $t_{JITper}$		ps	
Clock absolute high pulse width		$t_{CH}$ (ABS)	0.43	-	$t_{CK}$ (AVG)	14
Clock absolute low pulse width		$t_{CL}$ (ABS)	0.43	-	$t_{CK}$ (AVG)	15
Cycle-to-cycle jitter	DLL locked	$t_{JITcc}$	140		ps	16
	DLL locking	$t_{JITcc,lck}$	120		ps	16
Cumulative error across	2 cycles	$t_{ERR2per}$	-103	103	ps	17
	3 cycles	$t_{ERR3per}$	-122	122	ps	17
	4 cycles	$t_{ERR4per}$	-136	136	ps	17
	5 cycles	$t_{ERR5per}$	-147	147	ps	17
	6 cycles	$t_{ERR6per}$	-155	155	ps	17
	7 cycles	$t_{ERR7per}$	-163	163	ps	17
	8 cycles	$t_{ERR8per}$	-169	169	ps	17
	9 cycles	$t_{ERR9per}$	-175	175	ps	17
	10 cycles	$t_{ERR10per}$	-180	180	ps	17
	11 cycles	$t_{ERR11per}$	-184	184	ps	17
	12 cycles	$t_{ERR12per}$	-188	188	ps	17
	$n = 13, 14 \dots 49, 50$ cycles	$t_{ERRnper}$	$t_{ERRnper} \text{ MIN} = (1 + 0.68\ln[n]) \times t_{JITper} \text{ MIN}$ $t_{ERRnper} \text{ MAX} = (1 + 0.68\ln[n]) \times t_{JITper} \text{ MAX}$		ps	17



Electrical Characteristics and AC Operating Conditions (Continued)

Notes 1–8 apply to the entire table

Parameter	Symbol	DDR3L-1600		Unit	Notes	
		Min	Max			
<b>DQ Input Timing</b>						
Data setup time to DQS, DQS#	Base (specification)	<sup>t</sup> DS (AC160)	–	–	ps	18, 19, 44
	V <sub>REF</sub> @ 1 V/ns		–	–	ps	19, 20
Data setup time to DQS, DQS#	Base (specification)	<sup>t</sup> DS (AC135)	25	–	ps	18, 19, 44
	V <sub>REF</sub> @ 1 V/ns		160	–	ps	19, 20
Data hold time from DQS, DQS#	Base (specification)	<sup>t</sup> DH (DC90)	55	–	ps	18, 19
	V <sub>REF</sub> @ 1 V/ns		145	–	ps	19, 20
Minimum data pulse width	<sup>t</sup> DIPW	360	–	ps	41	
<b>DQ Output Timing</b>						
DQS, DQS# to DQ skew, per access	<sup>t</sup> DQSQ	–	100	ps		
DQ output hold time from DQS, DQS#	<sup>t</sup> QH	0.38	–	<sup>t</sup> CK (AVG)	21	
DQ Low-Z time from CK, CKB	<sup>t</sup> LZDQ	–450	225	ps	22, 23	
DQ High-Z time from CK, CKB	<sup>t</sup> HZDQ	–	225	ps	22, 23	
<b>DQ Strobe Input Timing</b>						
DQS, DQS# rising to CK, CKB rising	<sup>t</sup> DQSS	–0.27	0.27	CK	25	
DQS, DQS# differential input low pulse width	<sup>t</sup> DQSL	0.45	0.55	CK		
DQS, DQS# differential input high pulse width	<sup>t</sup> DQSH	0.45	0.55	CK		
DQS, DQS# falling setup to CK, CKB rising	<sup>t</sup> DSS	0.18	–	CK	25	
DQS, DQS# falling hold from CK, CKB rising	<sup>t</sup> DSH	0.18	–	CK	25	
DQS, DQS# differential WRITE preamble	<sup>t</sup> WPRE	0.9	–	CK		
DQS, DQS# differential WRITE postamble	<sup>t</sup> WPST	0.3	–	CK		
<b>DQ Strobe Output Timing</b>						
DQS, DQS# rising to/from rising CK, CKB	<sup>t</sup> DQSCK	–225	225	ps	23	
DQS, DQS# rising to/from rising CK, CKB when DLL is disabled	<sup>t</sup> DQSCK (DLL_DIS)	1	10	ns	26	
DQS, DQS# differential output high time	<sup>t</sup> QSH	0.40	–	CK	21	
DQS, DQS# differential output low time	<sup>t</sup> QSL	0.40	–	CK	21	



**Electrical Characteristics and AC Operating Conditions (Continued)**

Notes 1–8 apply to the entire table

Parameter	Symbol	DDR3L-1600		Unit	Notes	
		Min	Max			
DQS, DQS# Low-Z time (RL - 1)	<sup>t</sup> LZDQS	-450	225	ps	22, 23	
DQS, DQS# High-Z time (RL + BL/2)	<sup>t</sup> HZDQS	-	225	ps	22, 23	
DQS, DQS# differential READ preamble	<sup>t</sup> RPRE	0.9	Note 24	CK	23, 24	
DQS, DQS# differential READ postamble	<sup>t</sup> RPST	0.3	Note 27	CK	23, 27	
<b>Command and Address Timing</b>						
DLL locking time	<sup>t</sup> DLLK	512	-	CK	28	
CTRL, CMD, ADDR setup to CK,CKB	Base (specification)	<sup>t</sup> IS (AC160)	60	-	ps	29, 30, 44
	V <sub>REF</sub> @ 1 V/ns		220	-	ps	20, 30
CTRL, CMD, ADDR setup to CK,CKB	Base (specification)	<sup>t</sup> IS (AC135)	185	-	ps	29, 30, 44
	V <sub>REF</sub> @ 1 V/ns		320	-	ps	20, 30
CTRL, CMD, ADDR setup to CK,CKB	Base (specification)	<sup>t</sup> IH (DC90)	130	-	ps	29, 30, 44
	V <sub>REF</sub> @ 1 V/ns		220	-	ps	20, 30
Minimum CTRL, CMD, ADDR pulse width	<sup>t</sup> IPW	560	-	ps	41	
ACTIVATE to internal READ or WRITE delay	<sup>t</sup> RCD	See Speed Bin Tables for tRCD		ns	31	
PRECHARGE command period	<sup>t</sup> RP	See Speed Bin Tables for tRP		ns	31	
ACTIVATE-to-PRECHARGE command period	<sup>t</sup> RAS	See Speed Bin Tables for tRAS		ns	31, 32	
ACTIVATE-to-ACTIVATE command period	<sup>t</sup> RC	See Speed Bin Tables for tRC		ns	31, 43	
ACTIVATE-to-ACTIVATE minimum command period	X8 (1KB page size)	<sup>t</sup> RRD	MIN = greater of 4CK or 6ns		CK	31
	X16 (2KB page size)		MIN = greater of 4CK or 7.5ns		CK	31
Four ACTIVATE windows	X8 (1KB page size)	<sup>t</sup> FAW	30	-	ns	31
	X16 (2KB page size)		40		ns	31
Write recovery time	<sup>t</sup> WR	MIN = 15ns; MAX = N/A		ns	31, 32, 33, 34	
Delay from start of internal WRITE transaction to internal READ command	<sup>t</sup> WTR	MIN = greater of 4CK or 7.5ns; MAX = N/A		CK	31, 34	
READ-to-PRECHARGE time	<sup>t</sup> RTP	MIN = greater of 4CK or 7.5ns; MAX = N/A		CK	31, 32	



**Electrical Characteristics and AC Operating Conditions (Continued)**

Notes 1–8 apply to the entire table

Parameter	Symbol	DDR3L-1600		Unit	Notes
		Min	Max		
CASB-to-CASB command delay	<sup>t</sup> CCD	MIN = 4CK; MAX = N/A		CK	
Auto precharge write recovery + precharge time	<sup>t</sup> DAL	MIN = WR + <sup>t</sup> RP/ <sup>t</sup> CK (AVG); MAX = N/A		CK	
MODE REGISTER SET command cycle time	<sup>t</sup> MRD	MIN = 4CK; MAX = N/A		CK	
MODE REGISTER SET command update delay	<sup>t</sup> MOD	MIN = greater of 12CK or 15ns; MAX = N/A		CK	
MULTIPURPOSE REGISTER READ burst end to mode register set for multipurpose register exit	<sup>t</sup> MPRR	MIN = 1CK; MAX = N/A		CK	
<b>Calibration Timing</b>					
ZQCL command: Long calibration time	POWER-UP and RE-SET operation	<sup>t</sup> ZQinit	512	–	CK
	Normal operation	<sup>t</sup> ZQoper	256	–	CK
ZQCS command: Short calibration time		<sup>t</sup> ZQCS	64	–	CK
<b>Initialization and Reset Timing</b>					
Exit reset from CKE HIGH to a valid command		<sup>t</sup> XPR	MIN = greater of 5CK or <sup>t</sup> RFC + 10ns; MAX = N/A		CK
Begin power supply ramp to power supplies stable		<sup>t</sup> VDDPR	MIN = N/A; MAX = 200		ms
RESET# LOW to power supplies stable		<sup>t</sup> RPS	MIN = 0; MAX = 200		ms
RESET# LOW to I/O and R <sub>TT</sub> High-Z		<sup>t</sup> IOZ	MIN = N/A; MAX = 20		ns
<b>Refresh Timing</b>					
REFRESH-to-ACTIVATE or REFRESH command period		<sup>t</sup> RFC – 1Gb	MIN = 110; MAX = 70,200		ns
		<sup>t</sup> RFC – 2Gb	MIN = 160; MAX = 70,200		ns
		<sup>t</sup> RFC – 4Gb	MIN = 260; MAX = 70,200		ns
		<sup>t</sup> RFC – 8Gb	MIN = 350; MAX = 70,200		ns
Maximum refresh period	T <sub>C</sub> ≤ 85°C	–	64 (1X)		ms
	T <sub>C</sub> > 85°C	–	32 (2X)		ms
Maximum average periodic refresh	T <sub>C</sub> ≤ 85°C	<sup>t</sup> REFI	7.8 (64ms/8192)		μs
	T <sub>C</sub> > 85°C	<sup>t</sup> REFI	3.9 (32ms/8192)		μs
<b>Self Refresh Timing</b>					
Exit self refresh to commands not requiring a locked DLL		<sup>t</sup> XS	MIN = greater of 5CK or <sup>t</sup> RFC + 10ns; MAX = N/A		CK





**Electrical Characteristics and AC Operating Conditions (Continued)**

Notes 1–8 apply to the entire table

Parameter	Symbol	DDR3L-1600		Unit	Notes
		Min	Max		
Exit self refresh to commands requiring a locked DLL	<sup>t</sup> XSDLL	MIN = <sup>t</sup> DLLK (MIN); MAX = N/A		CK	28
Minimum CKE low pulse width for self refresh entry to self refresh exit timing	<sup>t</sup> CKESR	MIN = <sup>t</sup> CKE (MIN) + CK; MAX = N/A		CK	
Valid clocks after self refresh entry or power-down entry	<sup>t</sup> CKSRE	MIN = greater of 5CK or 10ns; MAX = N/A		CK	
Valid clocks before self refresh exit, power-down exit, or reset exit	<sup>t</sup> CKSRX	MIN = greater of 5CK or 10ns; MAX = N/A		CK	
<b>Power-Down Timing</b>					
CKE MIN pulse width	<sup>t</sup> CKE (MIN)	Greater of 3CK or 5ns		CK	
Command pass disable delay	<sup>t</sup> CPDED	MIN = 1; MAX = N/A		CK	
Power-down entry to power-down exit timing	<sup>t</sup> PD	MIN = <sup>t</sup> CKE (MIN); MAX = 9 * tREFI		CK	
Begin power-down period prior to CKE registered HIGH	<sup>t</sup> ANPD	WL - 1CK		CK	
Power-down entry period: ODT either synchronous or asynchronous	PDE	Greater of <sup>t</sup> ANPD or <sup>t</sup> RFC - REFRESH command to CKE LOW time		CK	
Power-down exit period: ODT either synchronous or asynchronous	PDX	<sup>t</sup> ANPD + <sup>t</sup> XPDLL		CK	
<b>Power-Down Entry Minimum Timing</b>					
ACTIVATE command to power-down entry	<sup>t</sup> ACTPDEN	MIN = 1		CK	
PRECHARGE/PRECHARGE ALL command to power-down entry	<sup>t</sup> PRPDEN	MIN = 1		CK	
REFRESH command to power-down entry	<sup>t</sup> REFPDEN	MIN = 1		CK	37
MRS command to power-down entry	<sup>t</sup> MRSPDEN	MIN = <sup>t</sup> MOD (MIN)		CK	
READ/READ with auto precharge command to power-down entry	<sup>t</sup> RDPDEN	MIN = RL + 4 + 1		CK	
WRITE command to power-down entry	BL8 (OTF, MRS) BC4OTF	<sup>t</sup> WRPDEN	MIN = WL + 4 + <sup>t</sup> WR/ <sup>t</sup> CK (AVG)	CK	
	BC4MRS	<sup>t</sup> WRPDEN	MIN = WL + 2 + <sup>t</sup> WR/ <sup>t</sup> CK (AVG)	CK	



**Electrical Characteristics and AC Operating Conditions (Continued)**

Notes 1–8 apply to the entire table

Parameter		Symbol	DDR3L-1600		Unit	Notes
			Min	Max		
WRITE with auto precharge command to power-down entry	BL8 (OTF, MRS)	<sup>t</sup> WRAP-DEN	MIN = WL + 4 + WR + 1		CK	
	BC4MRS	<sup>t</sup> WRAP-DEN	MIN = WL + 2 + WR + 1		CK	
<b>Power-Down Exit Timing</b>						
DLL on, any valid command, or DLL off to commands not requiring locked DLL		<sup>t</sup> XP	MIN = greater of 3CK or 6ns; MAX = N/A		CK	
Precharge power-down with DLL off to commands requiring a locked DLL		<sup>t</sup> XPDLL	MIN = greater of 10CK or 24ns; MAX = N/A		CK	28
<b>ODT Timing</b>						
R <sub>TT</sub> synchronous turn-on delay		ODTLon	CWL + AL - 2CK		CK	38
R <sub>TT</sub> synchronous turn-off delay		ODTLoff	CWL + AL - 2CK		CK	40
R <sub>TT</sub> turn-on from ODTL on reference		<sup>t</sup> AON	-225	225	ps	23, 38
R <sub>TT</sub> turn-off from ODTL off reference		<sup>t</sup> AOF	0.3	0.7	CK	39, 40
Asynchronous R <sub>TT</sub> turn-on delay (power-down with DLL off)		<sup>t</sup> AONPD	MIN = 2; MAX = 8.5		ns	38
Asynchronous R <sub>TT</sub> turn-off delay (power-down with DLL off)		<sup>t</sup> AOFPD	MIN = 2; MAX = 8.5		ns	40
ODT HIGH time with WRITE command and BL8		ODTH8	MIN = 6; MAX = N/A		CK	
ODT HIGH time without WRITE command or with WRITE command and BC4		ODTH4	MIN = 4; MAX = N/A		CK	
<b>Dynamic ODT Timing</b>						
R <sub>TT,nom</sub> -to-R <sub>TT(WR)</sub> change skew		ODTLcnw	WL - 2CK		CK	
R <sub>TT(WR)</sub> -to-R <sub>TT,nom</sub> change skew - BC4		ODTLcwn4	4CK + ODTLoff		CK	
R <sub>TT(WR)</sub> -to-R <sub>TT,nom</sub> change skew - BL8		ODTLcwn8	6CK + ODTLoff		CK	
R <sub>TT</sub> dynamic change skew		<sup>t</sup> ADC	0.3	0.7	CK	39
<b>Write Leveling Timing</b>						
First DQS, DQS# rising edge		<sup>t</sup> WLMRD	40	-	CK	
DQS, DQS# delay		<sup>t</sup> WLDQSEN	25	-	CK	
Write leveling setup from rising CK, CKB crossing to rising DQS, DQS# crossing		<sup>t</sup> WLS	165	-	ps	

**Electrical Characteristics and AC Operating Conditions (Continued)**

Notes 1–8 apply to the entire table

Parameter	Symbol	DDR3L-1600		Unit	Notes
		Min	Max		
Write leveling hold from rising DQS, DQS# crossing to rising CK, CKB crossing	<sup>t</sup> WLH	165	-	ps	
Write leveling output delay	<sup>t</sup> WLO	0	7.5	ns	
Write leveling output error	<sup>t</sup> WLOE	0	2	ns	



- Notes:
- 1 AC timing parameters are valid from specified TC MIN to TC MAX values.
  - 2 All voltages are referenced to VSS.
  - 3 Output timings are only valid for RON34 output buffer selection.
  - 4 The unit tCK (AVG) represents the actual tCK (AVG) of the input clock under operation. The unit CK represents one clock cycle of the input clock, counting the actual clock edges.
  - 5 AC timing and IDD tests may use a VIL-to-VIH swing of up to 900mV in the test environment, but input timing is still referenced to VREF (except tIS, tIH, tDS, and tDH use the AC/DC trip points and CK, CKB and DQS, DQS# use their crossing points). The minimum slew rate for the input signals used to test the device is 1 V/ns for single-ended inputs and 2 V/ns for differential inputs in the range between VIL(AC) and VIH(AC).
  - 6 All timings that use time-based values (ns,  $\mu$ s, ms) should use tCK (AVG) to determine the correct number of clocks uses CK or tCK [AVG] interchangeably). In the case of non-integer results, all minimum limits are to be rounded up to the nearest whole integer, and all maximum limits are to be rounded down to the nearest whole integer.
  - 7 Strobe or DQS diff refers to the DQS and DQS# differential crossing point when DQS is the rising edge. Clock or CK refers to the CK and CKB differential crossing point when CK is the rising edge.
  - 8 This output load is used for all AC timing (except ODT reference timing) and slew rates. The actual test load may be different. The output signal voltage reference point is VDDQ/2 for single-ended signals and the crossing point for differential signals.
  - 9 When operating in DLL disable mode, PTC does not warrant compliance with normal mode timings or functionality.
  - 10 The clock's tCK (AVG) is the average clock over any 200 consecutive clocks and tCK(AVG) MIN is the smallest clock rate allowed, with the exception of a deviation due to clock jitter. Input clock jitter is allowed provided it does not exceed values specified and must be of a random Gaussian distribution in nature.
  - 11 Spread spectrum is not included in the jitter specification values. However, the input clock can accommodate spread-spectrum at a sweep rate in the range of 20–60 kHz with an additional 1% of tCK (AVG) as a long-term jitter component; however, the spread spectrum may not use a clock rate below tCK (AVG) MIN.
  - 12 The clock's tCH (AVG) and tCL (AVG) are the average half clock period over any 200 consecutive clocks and is the smallest clock half period allowed, with the exception of a deviation due to clock jitter. Input clock jitter is allowed provided it does not exceed values specified and must be of a random Gaussian distribution in nature.
  - 13 The period jitter (tJITper) is the maximum deviation in the clock period from the average or nominal clock. It is allowed in either the positive or negative direction.
  - 14 tCH (ABS) is the absolute instantaneous clock high pulse width as measured from one rising edge to the following falling edge.
  - 15 tCL (ABS) is the absolute instantaneous clock low pulse width as measured from one falling edge to the following rising edge.
  - 16 The cycle-to-cycle jitter tJITcc is the amount the clock period can deviate from one cycle to the next. It is important to keep cycle-to-cycle jitter at a minimum during the DLL locking time.
  - 17 The cumulative jitter error tERRnper, where  $n$  is the number of clocks between 2 and 50, is the amount of clock time allowed to accumulate consecutively away from the average clock over  $n$  number of clock cycles.
  - 18 tDS (base) and tDH (base) values are for a single-ended 1 V/ns slew rate DQs and 2 V/ns slew rate differential DQS, DQS#; when DQ single-ended slew rate is 2V/ns, the DQS differential slew rate is 4V/ns.



- 19 These parameters are measured from a data signal (DM, DQ0, DQ1, and so forth) transition edge to its respective data strobe signal (DQS, DQS#) crossing.
- 20 The setup and hold times are listed converting the base specification values (to which derating tables apply) to VREF when the slew rate is 1 V/ns. These values, with a slew rate of 1 V/ns, are for reference only.
- 21 When the device is operated with input clock jitter, this parameter needs to be derated by the actual  $t_{JITper}$  (larger of  $t_{JITper} (MIN)$  or  $t_{JITper} (MAX)$  of the input clock (output deratings are relative to the SDRAM input clock).
- 22 Single-ended signal parameter.
- 23 The DRAM output timing is aligned to the nominal or average clock. Most output parameters must be derated by the actual jitter error when input clock jitter is present, even when within specification. This results in each parameter becoming larger. The following parameters are required to be derated by subtracting  $t_{ERR10per} (MAX)$ :  $t_{DQCK} (MIN)$ ,  $t_{LZDQS} (MIN)$ ,  $t_{LZDQ} (MIN)$ , and  $t_{AON} (MIN)$ . The following parameters are required to be derated by subtracting  $t_{ERR10per} (MIN)$ :  $t_{DQCK} (MAX)$ ,  $t_{HZ} (MAX)$ ,  $t_{LZDQS} (MAX)$ ,  $t_{LZDQ} (MAX)$ , and  $t_{AON} (MAX)$ . The parameter  $t_{RPRE} (MIN)$  is derated by subtracting  $t_{JITper} (MAX)$ , while  $t_{RPRE} (MAX)$  is derated by subtracting  $t_{JITper} (MIN)$ .
- 24 The maximum preamble is bound by  $t_{LZDQS} (MAX)$ .
- 25 These parameters are measured from a data strobe signal (DQS, DQS#) crossing to its respective clock signal (CK, CKB) crossing. The specification values are not affected by the amount of clock jitter applied, as these are relative to the clock signal crossing. These parameters should be met whether clock jitter is present.
- 26 The  $t_{DQCK} (DLL\_DIS)$  parameter begins  $CL + AL - 1$  cycles after the READ command.
- 27 The maximum postamble is bound by  $t_{HZDQS} (MAX)$ .
- 28 Commands requiring a locked DLL are: READ (and RDAP) and synchronous ODT commands. In addition, after any change of latency  $t_{XPDLL}$ , timing must be met.
- 29  $t_{IS} (base)$  and  $t_{IH} (base)$  values are for a single-ended 1 V/ns control/command/address slew rate and 2 V/ns CK, CKB differential slew rate.
- 30 These parameters are measured from a command/address signal transition edge to its respective clock (CK, CKB) signal crossing. The specification values are not affected by the amount of clock jitter applied as the setup and hold times are relative to the clock signal crossing that latches the command/address. These parameters should be met whether clock jitter is present.
- 31 For these parameters, the DDR3L SDRAM device supports  $t_{nPARAM} (nCK) = RU(t_{PARAM} [ns]/t_{CK}[AVG] [ns])$ , assuming all input clock jitter specifications are satisfied. For example, the device will support  $t_{nRP} (nCK) = RU(t_{RP}/t_{CK}[AVG])$  if all input clock jitter specifications are met. This means that for DDR3-800 6-6-6, of which  $t_{RP} = 5ns$ , the device will support  $t_{nRP} = RU(t_{RP}/t_{CK}[AVG]) = 6$  as long as the input clock jitter specifications are met. That is, the PRECHARGE command at  $T_0$  and the ACTIVATE command at  $T_0 + 6$  are valid even if six clocks are less than 15ns due to input clock jitter.
- 32 During READs and WRITEs with auto precharge, the DDR3 SDRAM will hold off the internal PRECHARGE command until  $t_{RAS} (MIN)$  has been satisfied.
- 33 When operating in DLL disable mode, the greater of  $4CK$  or 15ns is satisfied for  $t_{WR}$ .
- 34 The start of the write recovery time is defined as follows:
- For BL8 (fixed by MRS or OTF): Rising clock edge four clock cycles after WL
  - For BC4 (OTF): Rising clock edge four clock cycles after WL
  - For BC4 (fixed by MRS): Rising clock edge two clock cycles after WL
- 35 RESET# should be LOW as soon as power starts to ramp to ensure the outputs are in High-Z. Until RESET# is LOW, the outputs are at risk of driving and could result in



excessive current, depending on bus activity.

- 36 The refresh period is 64ms when TC is less than or equal to 85°C. This equates to an average refresh rate of 7.8125 $\mu$ s. However, nine REFRESH commands should be asserted at least once every 70.3 $\mu$ s. When TC is greater than 85°C, the refresh period is 32ms.
- 37 Although CKE is allowed to be registered LOW after a REFRESH command when tREFPDEN (MIN) is satisfied, there are cases where additional time such as tXPDLL (MIN) is required.
- 38 ODT turn-on time MIN is when the device leaves High-Z and ODT resistance begins to turn on. ODT turn-on time maximum is when the ODT resistance is fully on. The ODT reference load is shown. This output load is used for ODT timings. Designs that were created prior to JEDEC tightening the maximum limit from 9ns to 8.5ns will be allowed to have a 9ns maximum.
- 39 Half-clock output parameters must be derated by the actual tERR10per and tJITdty when input clock jitter is present. This results in each parameter becoming larger. The parameters tADC (MIN) and tAOF (MIN) are each required to be derated by subtracting both tERR10per (MAX) and tJITdty (MAX). The parameters tADC (MAX) and tAOF (MAX) are required to be derated by subtracting both tERR10per (MAX) and tJITdty (MAX).
- 40 ODT turn-off time minimum is when the device starts to turn off ODT resistance. ODT turnoff time maximum is when the DRAM buffer is in High-Z. The ODT reference load is shown. This output load is used for ODT timings.
- 41 Pulse width of a input signal is defined as the width between the first crossing of VREF(DC) and the consecutive crossing of VREF(DC).
- 42 Should the clock rate be larger than tRFC (MIN), an AUTO REFRESH command should have at least one NOP command between it and another AUTO REFRESH command. Additionally, if the clock rate is slower than 40ns (25 MHz), all REFRESH commands should be followed by a PRECHARGE ALL command.
- 43 DRAM devices should be evenly addressed when being accessed. Disproportionate accesses to a particular row address may result in a reduction of REFRESH characteristics or product lifetime.
- 44 When two VIH(AC) values (and two corresponding VIL(AC) values) are listed for a specific speed bin, the user may choose either value for the input AC level. Whichever value is used, the associated setup time for that AC level must also be used. Additionally, one VIH(AC) value may be used for address/command inputs and the other VIH(AC) value may be used for data inputs.

For example, for DDR3-800, two input AC levels are defined: VIH(AC175), min and VIH(AC150), min (corresponding VIL(AC175), min and VIL(AC150), min). For DDR3-800, the address/command inputs must use either VIH(AC175),min with tIS(AC175) of 200ps or VIH(AC150),min with tIS(AC150) of 350ps; independently, the data inputs must use either VIH(AC175),min with tDS(AC175) of 75ps or VIH(AC150),min with tDS(AC150) of 125ps.



## Electrical Characteristics and AC Operating Conditions for Speed Extensions

Notes 1–8 apply to the entire table

Parameter	Symbol	DDR3L-1866		DDR3L-2133		Unit	Notes	
		Min	Max	Min	Max			
<b>Clock Timing</b>								
Clock period average: DLL disable mode	$T_C = 0^\circ\text{C to } 85^\circ\text{C}$	$t_{CK}$ (DLL_DIS)	8	7800	8	7800	ns	9, 42
	$T_C = >85^\circ\text{C to } 95^\circ\text{C}$		8	3900	8	3900	ns	42
Clock period average: DLL enable mode		$t_{CK}$ (AVG)	See Speed Bin Tables for $t_{CK}$ range allowed ns					10, 11
High pulse width average		$t_{CH}$ (AVG)	0.47	0.53	0.47	0.53	CK	12
Low pulse width average		$t_{CL}$ (AVG)	0.47	0.53	0.47	0.53	CK	12
Clock period jitter	DLL locked	$t_{JITper}$	-60	60	-50	50	ps	13
	DLL locking	$t_{JITper,lck}$	-50	50	-40	40	ps	13
Clock absolute period		$t_{CK}$ (ABS)	MIN = $t_{CK}$ (AVG) MIN + $t_{JITper}$ MIN; MAX = $t_{CK}$ (AVG) MAX + $t_{JITper}$ MAX ps					
Clock absolute high pulse width		$t_{CH}$ (ABS)	0.43	-	0.43	-	$t_{CK}$ (AVG)	14
Clock absolute low pulse width		$t_{CL}$ (ABS)	0.43	-	0.43	-	$t_{CK}$ (AVG)	15
Cycle-to-cycle jitter	DLL locked	$t_{JITcc}$	120		120		ps	16
	DLL locking	$t_{JITcc,lck}$	100		100		ps	16



Electrical Characteristics and AC Operating Conditions for Speed Extensions (Continued)

Notes 1–8 apply to the entire table

Parameter		Symbol	DDR3L-1866		DDR3L-2133		Unit	Notes
			Min	Max	Min	Max		
Cumulative error across	2 cycles	<sup>t</sup> ERR2per	-88	88	-74	74	ps	17
	3 cycles	<sup>t</sup> ERR3per	-105	105	-87	87	ps	17
	4 cycles	<sup>t</sup> ERR4per	-117	117	-97	97	ps	17
	5 cycles	<sup>t</sup> ERR5per	-126	126	-105	105	ps	17
	6 cycles	<sup>t</sup> ERR6per	-133	133	-111	111	ps	17
	7 cycles	<sup>t</sup> ERR7per	-139	139	-116	116	ps	17
	8 cycles	<sup>t</sup> ERR8per	-145	145	-121	121	ps	17
	9 cycles	<sup>t</sup> ERR9per	-150	150	-125	125	ps	17
	10 cycles	<sup>t</sup> ERR10per	-154	154	-128	128	ps	17
	11 cycles	<sup>t</sup> ERR11per	-158	158	-132	132	ps	17
	12 cycles	<sup>t</sup> ERR12per	-161	161	-134	134	ps	17
	$n = 13, 14 \dots 49, 50$ cycles	<sup>t</sup> ERR $n$ per	<sup>t</sup> ERR $n$ per MIN = $(1 + 0.68\ln[n]) \times$ <sup>t</sup> JITper MIN <sup>t</sup> ERR $n$ per MAX = $(1 + 0.68\ln[n]) \times$ <sup>t</sup> JITper MAX				ps	17
<b>DQ Input Timing</b>								
Data setup time to DQS, DQS#	Base (specification) @ 2 V/ns	<sup>t</sup> DS (AC130)	70	-	55	-	ps	18, 19
	V <sub>REF</sub> @ 2 V/ns		135	-	120.5	-	ps	19, 20
Data hold time from DQS, DQS#	Base (specification) @ 2 V/ns	<sup>t</sup> DH (DC90)	75	-	60	-	ps	18, 19
	V <sub>REF</sub> @ 2 V/ns		110	-	105	-	ps	19, 20
Minimum data pulse width		<sup>t</sup> DIPW	320	-	280	-	ps	41
<b>DQ Output Timing</b>								
DQS, DQS# to DQ skew, per access		<sup>t</sup> DQSQ	-	85	-	75	ps	
DQ output hold time from DQS, DQS#		<sup>t</sup> QH	0.38	-	0.38	-	<sup>t</sup> CK (AVG)	21
DQ Low-Z time from CK, CK#		<sup>t</sup> LZDQ	-390	195	-360	180	ps	22, 23
DQ High-Z time from CK, CK#		<sup>t</sup> HZDQ	-	195	-	180	ps	22, 23
<b>DQ Strobe Input Timing</b>								
DQS, DQS# rising to CK, CK# rising		<sup>t</sup> DQSS	-0.27	0.27	-0.27	0.27	CK	25
DQS, DQS# differential input low pulse width		<sup>t</sup> DQSL	0.45	0.55	0.45	0.55	CK	



**Electrical Characteristics and AC Operating Conditions for Speed Extensions (Continued)**

Notes 1–8 apply to the entire table

Parameter	Symbol	DDR3L-1866		DDR3L-2133		Unit	Notes	
		Min	Max	Min	Max			
DQS, DQS# differential input high pulse width	<sup>t</sup> DQSH	0.45	0.55	0.45	0.55	CK		
DQS, DQS# falling setup to CK, CK# rising	<sup>t</sup> DSS	0.18	–	0.18	–	CK	25	
DQS, DQS# falling hold from CK, CK# rising	<sup>t</sup> DSH	0.18	–	0.18	–	CK	25	
DQS, DQS# differential WRITE preamble	<sup>t</sup> WPRE	0.9	–	0.9	–	CK		
DQS, DQS# differential WRITE postamble	<sup>t</sup> WPST	0.3	–	0.3	–	CK		
<b>DQ Strobe Output Timing</b>								
DQS, DQS# rising to/from rising CK, CK#	<sup>t</sup> DQSK	–195	195	–180	180	ps	23	
DQS, DQS# rising to/from rising CK, CK# when DLL is disabled	<sup>t</sup> DQSK (DLL_DIS)	1	10	1	10	ns	26	
DQS, DQS# differential output high time	<sup>t</sup> QSH	0.40	–	0.40	–	CK	21	
DQS, DQS# differential output low time	<sup>t</sup> QSL	0.40	–	0.40	–	CK	21	
DQS, DQS# Low-Z time (RL - 1)	<sup>t</sup> LZDQS	–390	195	–360	180	ps	22, 23	
DQS, DQS# High-Z time (RL + BL/2)	<sup>t</sup> HZDQS	–	195	–	180	ps	22, 23	
DQS, DQS# differential READ preamble	<sup>t</sup> RPRE	0.9	Note 24	0.9	Note 24	CK	23, 24	
DQS, DQS# differential READ postamble	<sup>t</sup> RPST	0.3	Note 27	0.3	Note 27	CK	23, 27	
<b>Command and Address Timing</b>								
DLL locking time	<sup>t</sup> DLLK	512	–	512	–	CK	28	
CTRL, CMD, ADDR setup to CK,CK#	Base (specification)	<sup>t</sup> IS (AC135)	65	–	60	–	ps	29, 30, 44
	V <sub>REF</sub> @ 1 V/ns		200	–	195	–	ps	20, 30
CTRL, CMD, ADDR setup to CK,CK#	Base (specification)	<sup>t</sup> IS (AC125)	150	–	135	–	ps	29, 30, 44
	V <sub>REF</sub> @ 1 V/ns		275	–	260	–	ps	20, 30
CTRL, CMD, ADDR hold from CK,CK#	Base (specification)	<sup>t</sup> IH (DC90)	110	–	95	–	ps	29, 30
	V <sub>REF</sub> @ 1 V/ns		200	–	195	–	ps	20, 30
Minimum CTRL, CMD, ADDR pulse width	<sup>t</sup> IPW	535	–	470	–	ps	41	
ACTIVATE to internal READ or WRITE delay	<sup>t</sup> RCD	See Speed Bin Tables for <sup>t</sup> RCD				ns	31	
PRECHARGE command period	<sup>t</sup> RP	See Speed Bin Tables for <sup>t</sup> RP				ns	31	
ACTIVATE-to-PRECHARGE command period	<sup>t</sup> RAS	See Speed Bin Tables for <sup>t</sup> RAS				ns	31, 32	
ACTIVATE-to-ACTIVATE command period	<sup>t</sup> RC	See Speed Bin Tables for <sup>t</sup> RC				ns	31, 43	





**Electrical Characteristics and AC Operating Conditions for Speed Extensions (Continued)**

Notes 1–8 apply to the entire table

Parameter		Symbol	DDR3L-1866		DDR3L-2133		Unit	Notes
			Min	Max	Min	Max		
ACTIVATE-to-ACTIVATE minimum command period	1KB page size	<sup>t</sup> RRD	MIN = greater of 4CK or 5ns				CK	31
	2KB page size		MIN = greater of 4CK or 6ns				CK	31
Four ACTIVATE windows	1KB page size	<sup>t</sup> FAW	27	–	25	–	ns	31
	2KB page size		35	–	35	–	ns	31
Write recovery time		<sup>t</sup> WR	MIN = 15ns; MAX = N/A				ns	31, 32, 33
Delay from start of internal WRITE transaction to internal READ command		<sup>t</sup> WTR	MIN = greater of 4CK or 7.5ns; MAX = N/A				CK	31, 34
READ-to-PRECHARGE time		<sup>t</sup> RTP	MIN = greater of 4CK or 7.5ns; MAX = N/A				CK	31, 32
CAS#-to-CAS# command delay		<sup>t</sup> CCD	MIN = 4CK; MAX = N/A				CK	
Auto precharge write recovery + precharge time		<sup>t</sup> DAL	MIN = WR + <sup>t</sup> RP/CK (AVG); MAX = N/A				CK	
MODE REGISTER SET command cycle time		<sup>t</sup> MRD	MIN = 4CK; MAX = N/A				CK	
MODE REGISTER SET command update delay		<sup>t</sup> MOD	MIN = greater of 12CK or 15ns; MAX = N/A				CK	
MULTIPURPOSE REGISTER READ burst end to mode register set for multipurpose register exit		<sup>t</sup> MPRR	MIN = 1CK; MAX = N/A				CK	
<b>Calibration Timing</b>								
ZQCL command: Long calibration time	POWER-UP and RE-SET operation	<sup>t</sup> ZQinit	MIN = N/A MAX = MAX(512nCK, 640ns)				CK	
	Normal operation	<sup>t</sup> ZQoper	MIN = N/A MAX = max(256nCK, 320ns)				CK	
ZQCS command: Short calibration time			MIN = N/A MAX = max(64nCK, 80ns) <sup>t</sup> ZQCS				CK	
<b>Initialization and Reset Timing</b>								
Exit reset from CKE HIGH to a valid command		<sup>t</sup> XPR	MIN = greater of 5CK or <sup>t</sup> RFC + 10ns; MAX = N/A				CK	
Begin power supply ramp to power supplies stable		<sup>t</sup> VDDPR	MIN = N/A; MAX = 200				ms	
RESET# LOW to power supplies stable		<sup>t</sup> RPS	MIN = 0; MAX = 200				ms	
RESET# LOW to I/O and R <sub>TT</sub> High-Z		<sup>t</sup> IOZ	MIN = N/A; MAX = 20				ns	35
<b>Refresh Timing</b>								



Electrical Characteristics and AC Operating Conditions for Speed Extensions (Continued)

Notes 1–8 apply to the entire table

Parameter	Symbol	DDR3L-1866		DDR3L-2133		Unit	Notes
		Min	Max	Min	Max		
REFRESH-to-ACTIVATE or REFRESH command period	<sup>t</sup> RFC – 1Gb	MIN = 110; MAX = 70,200				ns	
	<sup>t</sup> RFC – 2Gb	MIN = 160; MAX = 70,200				ns	
	<sup>t</sup> RFC – 4Gb	MIN = 260; MAX = 70,200				ns	
	<sup>t</sup> RFC – 8Gb	MIN = 350; MAX = 70,200				ns	
Maximum refresh period	$T_c \leq 85^\circ\text{C}$	64 (1X)				ms	36
	$T_c > 85^\circ\text{C}$	32 (2X)				ms	36
Maximum average periodic refresh	$T_c \leq 85^\circ\text{C}$	<sup>t</sup> REFI 7.8 (64ms/8192)				$\mu\text{s}$	36
	$T_c > 85^\circ\text{C}$	3.9 (32ms/8192)				$\mu\text{s}$	36
<b>Self Refresh Timing</b>							
Exit self refresh to commands not requiring a locked DLL	<sup>t</sup> XS	MIN = greater of 5CK or <sup>t</sup> RFC + 10ns; MAX = N/A				CK	
Exit self refresh to commands requiring a locked DLL	<sup>t</sup> XSDLL	MIN = <sup>t</sup> DLLK (MIN); MAX = N/A				CK	28
Minimum CKE low pulse width for self refresh entry to self refresh exit timing	<sup>t</sup> CKESR	MIN = <sup>t</sup> CKE (MIN) + CK; MAX = N/A				CK	
Valid clocks after self refresh entry or power-down entry	<sup>t</sup> CKSRE	MIN = greater of 5CK or 10ns; MAX = N/A				CK	
Valid clocks before self refresh exit, power-down exit, or reset exit	<sup>t</sup> CKSRX	MIN = greater of 5CK or 10ns; MAX = N/A				CK	
<b>Power-Down Timing</b>							
CKE MIN pulse width	<sup>t</sup> CKE (MIN)	Greater of 3CK or 5ns				CK	
Command pass disable delay	<sup>t</sup> CPDED	MIN = 2; MAX = N/A				CK	
Power-down entry to power-down exit timing	<sup>t</sup> PD	MIN = <sup>t</sup> CKE (MIN); MAX = 9 * <sup>t</sup> TREFI				CK	
Begin power-down period prior to CKE registered HIGH	<sup>t</sup> ANPD	WL - 1CK				CK	
Power-down entry period: ODT either synchronous or asynchronous	PDE	Greater of <sup>t</sup> ANPD or <sup>t</sup> RFC - REFRESH command to CKE LOW time				CK	
Power-down exit period: ODT either synchronous or asynchronous	PDX	<sup>t</sup> ANPD + <sup>t</sup> XPDLL				CK	
<b>Power-Down Entry Minimum Timing</b>							



**Electrical Characteristics and AC Operating Conditions for Speed Extensions (Continued)**

Notes 1–8 apply to the entire table

Parameter	Symbol	DDR3L-1866		DDR3L-2133		Unit	Notes
		Min	Max	Min	Max		
ACTIVATE command to power-down entry	<sup>t</sup> ACTPDEN	MIN = 2				CK	
PRECHARGE/PRECHARGE ALL command to power-down entry	<sup>t</sup> PRPDEN	MIN = 2				CK	
REFRESH command to power-down entry	<sup>t</sup> REFPDEN	MIN = 2				CK	37
MRS command to power-down entry	<sup>t</sup> MRSPDEN	MIN = <sup>t</sup> MOD (MIN)				CK	
READ/READ with auto precharge command to power-down entry	<sup>t</sup> RDPDEN	MIN = RL + 4 + 1				CK	
WRITE command to power-down entry	BL8 (OTF, MRS) BC4OTF	<sup>t</sup> WRPDEN	MIN = WL + 4 + <sup>t</sup> WR/ <sup>t</sup> CK (AVG)			CK	
	BC4MRS	<sup>t</sup> WRPDEN	MIN = WL + 2 + <sup>t</sup> WR/ <sup>t</sup> CK (AVG)			CK	
WRITE with auto pre-charge command to power-down entry	BL8 (OTF, MRS) BC4OTF	<sup>t</sup> WRAP-DEN	MIN = WL + 4 + WR + 1			CK	
	BC4MRS	<sup>t</sup> WRAP-DEN	MIN = WL + 2 + WR + 1			CK	
<b>Power-Down Exit Timing</b>							
DLL on, any valid command, or DLL off to commands not requiring locked DLL	<sup>t</sup> XP	MIN = greater of 3CK or 6ns; MAX = N/A				CK	
Precharge power-down with DLL off to commands requiring a locked DLL	<sup>t</sup> XPDLL	MIN = greater of 10CK or 24ns; MAX = N/A				CK	28
<b>ODT Timing</b>							
R <sub>TT</sub> synchronous turn-on delay	ODTL on	CWL + AL - 2CK				CK	38
R <sub>TT</sub> synchronous turn-off delay	ODTL off	CWL + AL - 2CK				CK	40
R <sub>TT</sub> turn-on from ODTL on reference	<sup>t</sup> AON	-195	195	-180	180	ps	23, 38
R <sub>TT</sub> turn-off from ODTL off reference	<sup>t</sup> AOF	0.3	0.7	0.3	0.7	CK	39, 40
Asynchronous R <sub>TT</sub> turn-on delay (power-down with DLL off)	<sup>t</sup> AONPD	MIN = 2; MAX = 8.5				ns	38
Asynchronous R <sub>TT</sub> turn-off delay (power-down with DLL off)	<sup>t</sup> AOFPD	MIN = 2; MAX = 8.5				ns	40
ODT HIGH time with WRITE command and BL8	ODTH8	MIN = 6; MAX = N/A				CK	



**Electrical Characteristics and AC Operating Conditions for Speed Extensions (Continued)**

Notes 1–8 apply to the entire table

Parameter	Symbol	DDR3L-1866		DDR3L-2133		Unit	Notes
		Min	Max	Min	Max		
ODT HIGH time without WRITE command or with WRITE command and BC4	ODTH4	MIN = 4; MAX = N/A				CK	
<b>Dynamic ODT Timing</b>							
R <sub>TT,nom</sub> -to-R <sub>TT(WR)</sub> change skew	ODTLcnw	WL - 2CK				CK	
R <sub>TT(WR)</sub> -to-R <sub>TT,nom</sub> change skew - BC4	ODTLcwn4	4CK + ODTLoff				CK	
R <sub>TT(WR)</sub> -to-R <sub>TT,nom</sub> change skew - BL8	ODTLcwn8	6CK + ODTLoff				CK	
R <sub>TT</sub> dynamic change skew	<sup>t</sup> ADC	0.3	0.7	0.3	0.7	CK	39
<b>Write Leveling Timing</b>							
First DQS, DQS# rising edge	<sup>t</sup> WLMRD	40	–	40	–	CK	
DQS, DQS# delay	<sup>t</sup> WLDQSEN	25	–	25	–	CK	
Write leveling setup from rising CK, CK# crossing to rising DQS, DQS# crossing	<sup>t</sup> WLS	140	–	125	–	ps	
Write leveling hold from rising DQS, DQS# crossing to rising CK, CK# crossing	<sup>t</sup> WLH	140	–	125	–	ps	
Write leveling output delay	<sup>t</sup> WLO	0	7.5	0	7	ns	
Write leveling output error	<sup>t</sup> WLOE	0	2	0	2	ns	

- Notes: 1 AC timing parameters are valid from specified TC MIN to TC MAX values.  
2 All voltages are referenced to VSS.



- 3 Output timings are only valid for RON34 output buffer selection.
- 4 The unit tCK (AVG) represents the actual tCK (AVG) of the input clock under operation. The unit CK represents one clock cycle of the input clock, counting the actual clock edges.
- 5 AC timing and IDD tests may use a VIL-to-VIH swing of up to 900mV in the test environment, but input timing is still referenced to VREF (except tIS, tIH, tDS, and tDH use the AC/DC trip points and CK, CKB and DQS, DQS# use their crossing points). The minimum slew rate for the input signals used to test the device is 1 V/ns for single-ended inputs (DQs are at 2V/ns for DDR3-1866 and DDR3-2133) and 2 V/ns for differential inputs in the range between VIL(AC) and VIH(AC).
- 6 All timings that use time-based values (ns,  $\mu$ s, ms) should use tCK (AVG) to determine the correct number of clocks uses CK or tCK [AVG] interchangeably). In the case of non integer results, all minimum limits are to be rounded up to the nearest whole integer, and all maximum limits are to be rounded down to the nearest whole integer.
- 7 Strobe or DQSdiff refers to the DQS and DQS# differential crossing point when DQS is the rising edge. Clock or CK refers to the CK and CKB differential crossing point when CK is the rising edge.
- 8 This output load is used for all AC timing (except ODT reference timing) and slew rates. The actual test load may be different. The output signal voltage reference point is VDDQ/2 for single-ended signals and the crossing point for differential signals.
- 9 When operating in DLL disable mode, PTC does not warrant compliance with normal mode timings or functionality.
- 10 The clock's tCK (AVG) is the average clock over any 200 consecutive clocks and tCK(AVG) MIN is the smallest clock rate allowed, with the exception of a deviation due to clock jitter. Input clock jitter is allowed provided it does not exceed values specified and must be of a random Gaussian distribution in nature.
- 11 Spread spectrum is not included in the jitter specification values. However, the input clock can accommodate spread-spectrum at a sweep rate in the range of 20–60 kHz with an additional 1% of tCK (AVG) as a long-term jitter component; however, the spread spectrum may not use a clock rate below tCK (AVG) MIN.
- 12 The clock's tCH (AVG) and tCL (AVG) are the average half clock period over any 200 consecutive clocks and is the smallest clock half period allowed, with the exception of a deviation due to clock jitter. Input clock jitter is allowed provided it does not exceed values specified and must be of a random Gaussian distribution in nature.
- 13 The period jitter (tJITper) is the maximum deviation in the clock period from the average or nominal clock. It is allowed in either the positive or negative direction.
- 14 tCH (ABS) is the absolute instantaneous clock high pulse width as measured from one rising edge to the following falling edge.
- 15 tCL (ABS) is the absolute instantaneous clock low pulse width as measured from one falling edge to the following rising edge.
- 16 The cycle-to-cycle jitter tJITcc is the amount the clock period can deviate from one cycle to the next. It is important to keep cycle-to-cycle jitter at a minimum during the DLL locking time.
- 17 The cumulative jitter error tERRnper, where  $n$  is the number of clocks between 2 and 50, is the amount of clock time allowed to accumulate consecutively away from the average clock over  $n$  number of clock cycles.
- 18 tDS (base) and tDH (base) values are for a single-ended 1 V/ns slew rate DQs (DQs are at 2V/ns for DDR3-1866 and DDR3-2133) and 2 V/ns slew rate differential DQS, DQS#; when DQ single- ended slew rate is 2V/ns, the DQS differential slew rate is 4V/ns.



- 19 These parameters are measured from a data signal (DM, DQ0, DQ1, and so forth) transition edge to its respective data strobe signal (DQS, DQS#) crossing.
- 20 20. The setup and hold times are listed converting the base specification values (to which derating tables apply) to VREF when the slew rate is 1 V/ns (DQs are at 2V/ns for DDR3-1866 and DDR3-2133). These values, with a slew rate of 1 V/ns (DQs are at 2V/ns for DDR3-1866 and DDR3-2133), are for reference only.
- 21 When the device is operated with input clock jitter, this parameter needs to be derated by the actual tJITper (larger of tJITper (MIN) or tJITper (MAX) of the input clock (output deratings are relative to the SDRAM input clock).
- 22 Single-ended signal parameter.
- 23 The DRAM output timing is aligned to the nominal or average clock. Most output parameters must be derated by the actual jitter error when input clock jitter is present, even when within specification. This results in each parameter becoming larger. The following parameters are required to be derated by subtracting tERR10per (MAX): tDQSCK (MIN), tLZDQS (MIN), tLZDQ (MIN), and tAON (MIN). The following parameters are required to be derated by subtracting tERR10per (MIN): tDQSCK (MAX), tHZ (MAX), tLZDQS (MAX), tLZDQ (MAX), and tAON (MAX). The parameter tRPRE (MIN) is derated by subtracting tJITper (MAX), while tRPRE (MAX) is derated by subtracting tJITper (MIN).
- 24 The maximum preamble is bound by tLZDQS (MAX).
- 25 These parameters are measured from a data strobe signal (DQS, DQS#) crossing to its respective clock signal (CK, CKB) crossing. The specification values are not affected by the amount of clock jitter applied, as these are relative to the clock signal crossing. These parameters should be met whether clock jitter is present.
- 26 The tDQSCK (DLL\_DIS) parameter begins CL + AL - 1 cycles after the READ command.
- 27 The maximum postamble is bound by tHZDQS (MAX).
- 28 Commands requiring a locked DLL are: READ (and RDAP) and synchronous ODT commands. In addition, after any change of latency tXPDLL, timing must be met.
- 29 tIS (base) and tIH (base) values are for a single-ended 1 V/ns control/command/address slew rate and 2 V/ns CK, CKB differential slew rate.
- 30 These parameters are measured from a command/address signal transition edge to its respective clock (CK, CKB) signal crossing. The specification values are not affected by the amount of clock jitter applied as the setup and hold times are relative to the clock signal crossing that latches the command/address. These parameters should be met whether clock jitter is present.
- 31 For these parameters, the DDR3L SDRAM device supports  $t_nPARAM (nCK) = RU(tPARAM [ns]/tCK[AVG] [ns])$ , assuming all input clock jitter specifications are satisfied. For example, the device will support  $t_nRP (nCK) = RU(tRP/tCK[AVG])$  if all input clock jitter specifications are met. This means that for DDR3-800 6-6-6, of which tRP = 5ns, the device will support  $t_nRP = RU(tRP/tCK[AVG]) = 6$  as long as the input clock jitter specifications are met. That is, the PRECHARGE command at T0 and the ACTIVATE command at T0 + 6 are valid even if six clocks are less than 15ns due to input clock jitter.
- 32 During READs and WRITEs with auto precharge, the DDR3 SDRAM will hold off the internal PRECHARGE command until tRAS (MIN) has been satisfied.
- 33 When operating in DLL disable mode, the greater of 5CK or 15ns is satisfied for tWR.
- 34 The start of the write recovery time is defined as follows:
- For BL8 (fixed by MRS or OTF): Rising clock edge four clock cycles after WL
  - For BC4 (OTF): Rising clock edge four clock cycles after WL
  - For BC4 (fixed by MRS): Rising clock edge two clock cycles after WL
- 35 RESET# should be LOW as soon as power starts to ramp to ensure the outputs are in High-Z. Until RESET# is LOW, the outputs are at risk of driving and could result in excessive current, depending on bus activity.



- 36 The refresh period is 64ms when TC is less than or equal to 85°C. This equates to an average refresh rate of 7.8125 $\mu$ s. However, nine REFRESH commands should be asserted at least once every 70.3 $\mu$ s. When TC is greater than 85°C, the refresh period is 32ms.
- 37 Although CKE is allowed to be registered LOW after a REFRESH command when tREFPDEN (MIN) is satisfied, there are cases where additional time such as tXPDLL (MIN) is required.
- 38 ODT turn-on time MIN is when the device leaves High-Z and ODT resistance begins to turn on. ODT turn-on time maximum is when the ODT resistance is fully on. The ODT reference load is shown. This output load is used for ODT timings. Designs that were created prior to JEDEC tightening the maximum limit from 9ns to 8.5ns will be allowed to have a 9ns maximum.
- 39 Half-clock output parameters must be derated by the actual tERR10per and tJITdy when input clock jitter is present. This results in each parameter becoming larger. The parameters tADC (MIN) and tAOF (MIN) are each required to be derated by subtracting both tERR10per (MAX) and tJITdy (MAX). The parameters tADC (MAX) and tAOF (MAX) are required to be derated by subtracting both tERR10per (MAX) and tJITdy (MAX).
- 40 ODT turn-off time minimum is when the device starts to turn off ODT resistance. ODT turnoff time maximum is when the DRAM buffer is in High-Z. The ODT reference load is shown. This output load is used for ODT timings.
- 41 Pulse width of an input signal is defined as the width between the first crossing of VREF(DC) and the consecutive crossing of VREF(DC).
- 42 Should the clock rate be larger than tRFC (MIN), an AUTO REFRESH command should have at least one NOP command between it and another AUTO REFRESH command. Additionally, if the clock rate is slower than 40ns (25 MHz), all REFRESH commands should be followed by a PRECHARGE ALL command.
- 43 DRAM devices should be evenly addressed when being accessed. Disproportionate accesses to a particular row address may result in a reduction of REFRESH characteristics or product lifetime.
- 44 When two VIH(AC) values (and two corresponding VIL(AC) values) are listed for a specific speed bin, the user may choose either value for the input AC level. Whichever value is used, the associated setup time for that AC level must also be used. Additionally, one VIH(AC) value may be used for address/command inputs and the other VIH(AC) value may be used for data inputs.  
For example, for DDR3-800, two input AC levels are defined: VIH(AC175), min and VIH(AC150), min (corresponding VIL(AC175), min and VIL(AC150), min). For DDR3-800, the address/command inputs must use either VIH(AC175), min with tIS(AC175) of 200ps or VIH(AC150),min with tIS(AC150) of 350ps; independently, the data inputs must use either VIH(AC175),min with tDS(AC175) of 75ps or VIH(AC150),min with tDS(AC150) of 125ps.



## 11. Setup, Hold, and Derating

### 11.1 Command and Address Setup, Hold, and Derating

The total tIS (setup time) and tIH (hold time) required is calculated by adding the data sheet tIS (base) and tIH (base) values to the  $\Delta tIS$  and  $\Delta tIH$  derating values respectively.

Example:  $tIS$  (total setup time) =  $tIS$  (base) +  $\Delta tIS$ . For a valid transition, the input signal has to remain above/below  $V_{IH(AC)}/V_{IL(AC)}$  for some time  $tVAC$ .

Although the total setup time for slow slew rates might be negative (for example, a valid input signal will not have reached  $V_{IH(AC)}/V_{IL(AC)}$  at the time of the rising clock transition), a valid input signal is still required to complete the transition and to reach  $V_{IH(AC)}/V_{IL(AC)}$  for input signal requirements). The derating values may be obtained by linear interpolation. Setup ( $tIS$ ) nominal slew rate for a rising signal is defined as the slew rate between the last crossing of  $V_{REF(DC)}$  and the first crossing of  $V_{IH(AC)min}$ . Setup ( $tIS$ ) nominal slew rate for a falling signal is defined as the slew rate between the last crossing of  $V_{REF(DC)}$  and the first crossing of  $V_{IL(AC)max}$ . If the actual signal is always earlier than the nominal slew rate line between the shaded  $V_{REF(DC)}$ -to-AC region, use the nominal slew rate for derating value. If the actual signal is later than the nominal slew rate line anywhere between the shaded  $V_{REF(DC)}$ -to-AC region, the slew rate of a tangent line to the actual signal from the AC level to the DC level is used for derating value. Hold ( $tIH$ ) nominal slew rate for a rising signal is defined as the slew rate between the last crossing of  $V_{IL(DC)max}$  and the first crossing of  $V_{REF(DC)}$ . Hold ( $tIH$ ) nominal slew rate for a falling signal is defined as the slew rate between the last crossing of  $V_{IH(DC)min}$  and the first crossing of  $V_{REF(DC)}$ . If the actual signal is always later than then nominal slew rate line between the shaded DC-to- $V_{REF(DC)}$  region, use the nominal slew rate for derating value. If the actual signal is earlier than the nominal slew rate line anywhere between the shaded DC-to- $V_{REF(DC)}$  region, the slew rate of a tangent line to the actual signal from the DC level to the  $V_{REF(DC)}$  level is used for derating value.

**DDR3L Command and Address Setup and Hold Values 1 V/ns Referenced – AC/DC-Based**

Symbol	1600	1866	2133	Unit	Reference
$tIS$ (base, AC160)	60	–	–	ps	$V_{IH(AC)}/V_{IL(AC)}$
$tIS$ (base, AC135)	185	65	60	ps	$V_{IH(AC)}/V_{IL(AC)}$
$tIS$ (base, AC125)	–	150	135	ps	$V_{IH(AC)}/V_{IL(AC)}$
$tIH$ (base, DC90)	130	110	105	ps	$V_{IH(DC)}/V_{IL(DC)}$





DDR3L-1600 Derating Values for  $t_{IS}/t_{IH}$  – AC135/DC90-Based

$\Delta t_{IS}, \Delta t_{IH}$ Derating (ps) – AC/DC-Based																
CMD/ADDR Slew Rate V/ns	CK, CKB Differential Slew Rate															
	4.0 V/ns		3.0 V/ns		2.0 V/ns		1.8 V/ns		1.6 V/ns		1.4 V/ns		1.2 V/ns		1.0 V/ns	
	$\Delta t_{IS}$	$\Delta t_{IH}$	$\Delta t_{IS}$	$\Delta t_{IH}$	$\Delta t_{IS}$	$\Delta t_{IH}$	$\Delta t_{IS}$	$\Delta t_{IH}$	$\Delta t_{IS}$	$\Delta t_{IH}$	$\Delta t_{IS}$	$\Delta t_{IH}$	$\Delta t_{IS}$	$\Delta t_{IH}$	$\Delta t_{IS}$	$\Delta t_{IH}$
2.0	68	45	68	45	68	45	76	53	84	61	92	69	100	79	108	95
1.5	45	30	45	30	45	30	53	38	61	46	69	54	77	64	85	80
1.0	0	0	0	0	0	0	8	8	16	16	24	24	32	34	40	50
0.9	2	-3	2	-3	2	-3	10	5	18	13	26	21	34	31	42	47
0.8	3	-8	3	-8	3	-8	11	1	19	9	27	17	35	27	43	43
0.7	6	-13	6	-13	6	-13	14	-5	22	3	30	11	38	21	46	37
0.6	9	-20	9	-20	9	-20	17	-12	25	-4	33	4	41	14	49	30
0.5	5	-30	5	-30	5	-30	13	-22	21	-14	29	-6	37	4	45	20
0.4	-3	-45	-3	-45	-3	-45	6	-37	14	-29	22	-21	30	-11	38	5

DDR3L-1866/2133 Derating Values for  $t_{IS}/t_{IH}$  – AC125/DC90-Based

$\Delta t_{IS}, \Delta t_{IH}$ Derating (ps) – AC/DC-Based																
CMD/ADDR Slew Rate V/ns	CK, CKB Differential Slew Rate															
	4.0 V/ns		3.0 V/ns		2.0 V/ns		1.8 V/ns		1.6 V/ns		1.4 V/ns		1.2 V/ns		1.0 V/ns	
	$\Delta t_{IS}$	$\Delta t_{IH}$	$\Delta t_{IS}$	$\Delta t_{IH}$	$\Delta t_{IS}$	$\Delta t_{IH}$	$\Delta t_{IS}$	$\Delta t_{IH}$	$\Delta t_{IS}$	$\Delta t_{IH}$	$\Delta t_{IS}$	$\Delta t_{IH}$	$\Delta t_{IS}$	$\Delta t_{IH}$	$\Delta t_{IS}$	$\Delta t_{IH}$
2.0	63	45	63	45	63	45	71	53	79	61	87	69	95	79	103	95
1.5	42	30	42	30	42	30	50	38	58	46	66	54	74	64	82	80



DDR3L-1866/2133 Derating Values for  $t_{IS}/t_{IH}$  – AC125/DC90-Based (Continued)

$\Delta t_{IS}, \Delta t_{IH}$ Derating (ps) – AC/DC-Based																
CMD/ADDR Slew Rate V/ns	CK, CKB Differential Slew Rate															
	4.0 V/ns		3.0 V/ns		2.0 V/ns		1.8 V/ns		1.6 V/ns		1.4 V/ns		1.2 V/ns		1.0 V/ns	
	$\Delta t_{IS}$	$\Delta t_{IH}$	$\Delta t_{IS}$	$\Delta t_{IH}$	$\Delta t_{IS}$	$\Delta t_{IH}$	$\Delta t_{IS}$	$\Delta t_{IH}$	$\Delta t_{IS}$	$\Delta t_{IH}$	$\Delta t_{IS}$	$\Delta t_{IH}$	$\Delta t_{IS}$	$\Delta t_{IH}$	$\Delta t_{IS}$	$\Delta t_{IH}$
1.0	0	0	0	0	0	0	8	8	16	16	24	24	32	34	40	50
0.9	3	-3	3	-3	3	-3	11	5	19	13	27	21	35	31	43	47
0.8	6	-8	6	-8	6	-8	14	1	22	9	30	17	38	27	46	43
0.7	10	-13	10	-13	10	-13	18	-5	26	3	34	11	42	21	50	37
0.6	16	-20	16	-20	16	-20	24	-12	32	-4	40	4	48	14	56	30
0.5	15	-30	15	-30	15	-30	23	-22	31	-14	39	-6	47	4	55	20
0.4	13	-45	13	-45	13	-45	21	-37	29	-29	37	-21	45	-11	53	5

DDR3L Minimum Required Time  $t_{VAC}$  Above  $V_{IH(AC)}$  (Below  $V_{IL(AC)}$ ) for Valid ADD/CMD Transition

Slew Rate (V/ns)	DDR3L-1600		DDR3L-1866/2133	
	$t_{VAC}$ at 160mV (ps)	$t_{VAC}$ at 135mV (ps)	$t_{VAC}$ at 135mV (ps)	$t_{VAC}$ at 125mV (ps)
>2.0	200	213	200	205
2.0	200	213	200	205
1.5	173	190	178	184
1.0	120	145	133	143
0.9	102	130	118	129
0.8	80	111	99	111
0.7	51	87	75	89
0.6	13	55	43	59
0.5	Note 1	10	Note 1	18
<0.5	Note 1	10	Note 1	18

Note: 1. Rising input signal shall become equal to or greater than  $V_{IH(AC)}$  level and Falling input signal shall become equal to or less than  $V_{IL(AC)}$  level.



**Nominal Slew Rate and  $t_{VAC}$  for  $t_{IS}$  (Command and Address – Clock)**

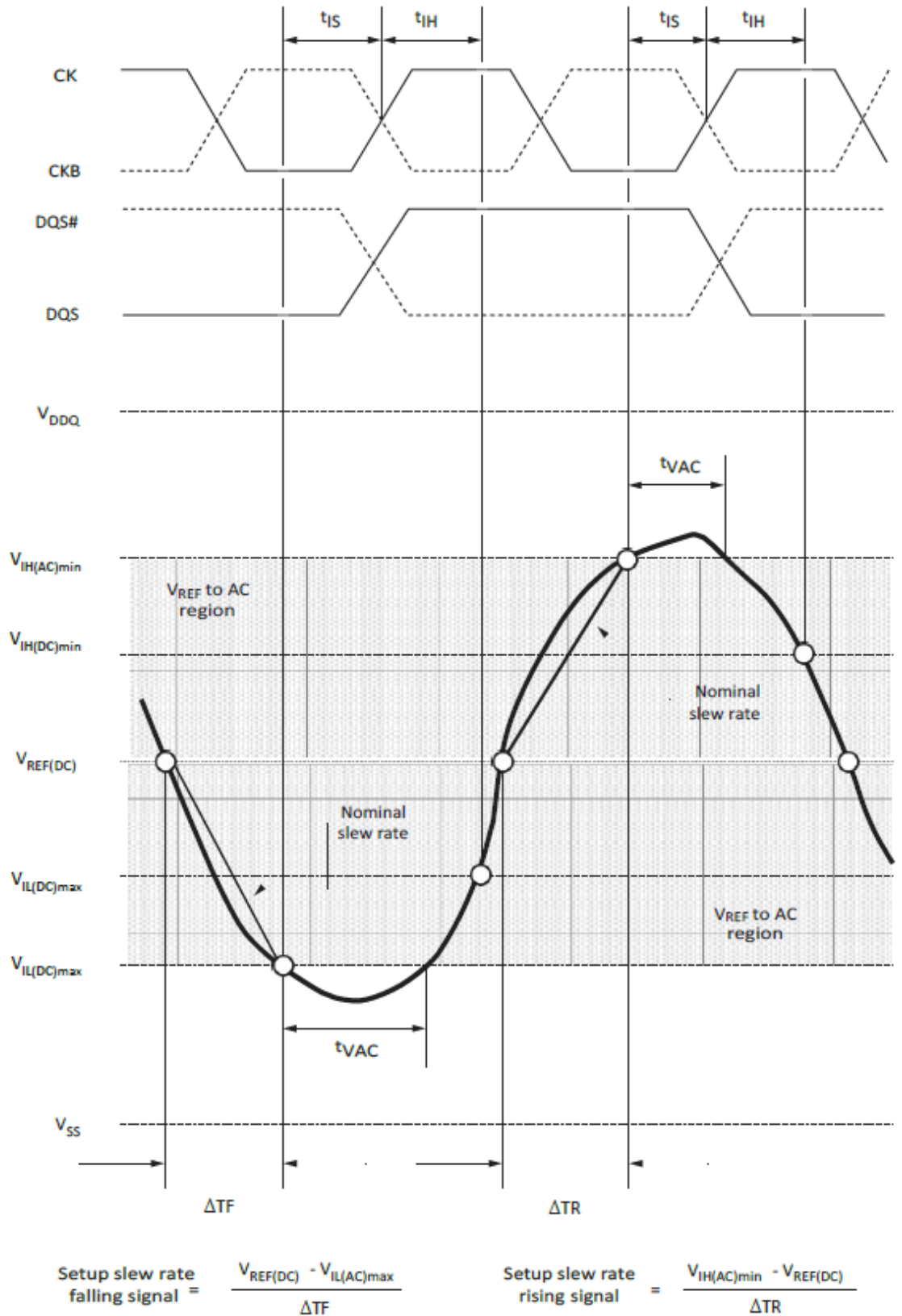

Note: 1. The clock and the strobe are drawn on different time scales.

**Nominal Slew Rate for  $t_{IH}$  (Command and Address – Clock)**

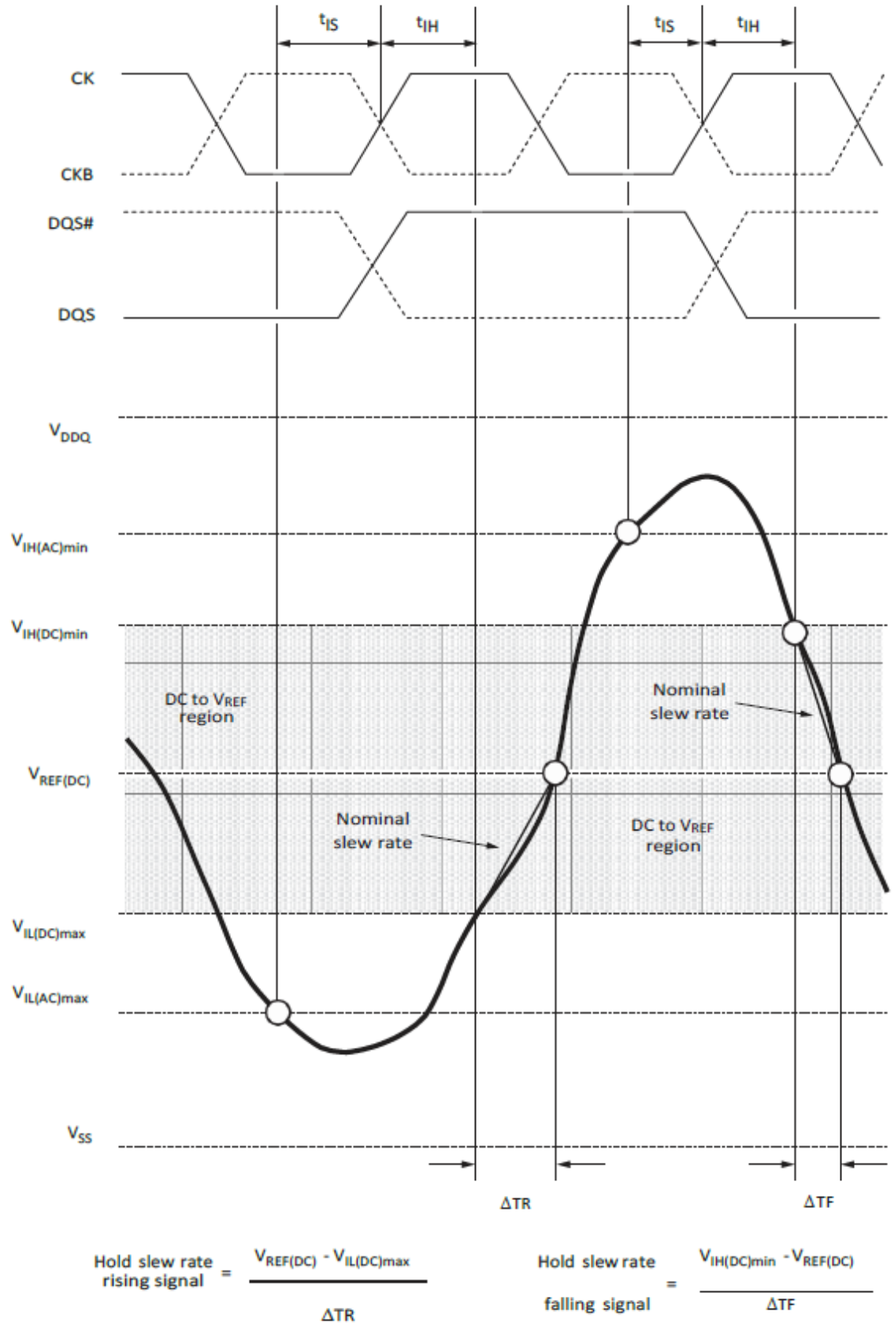

Note: 1. The clock and the strobe are drawn on different time scales.

**Tangent Line for  $t_{IS}$  (Command and Address – Clock)**

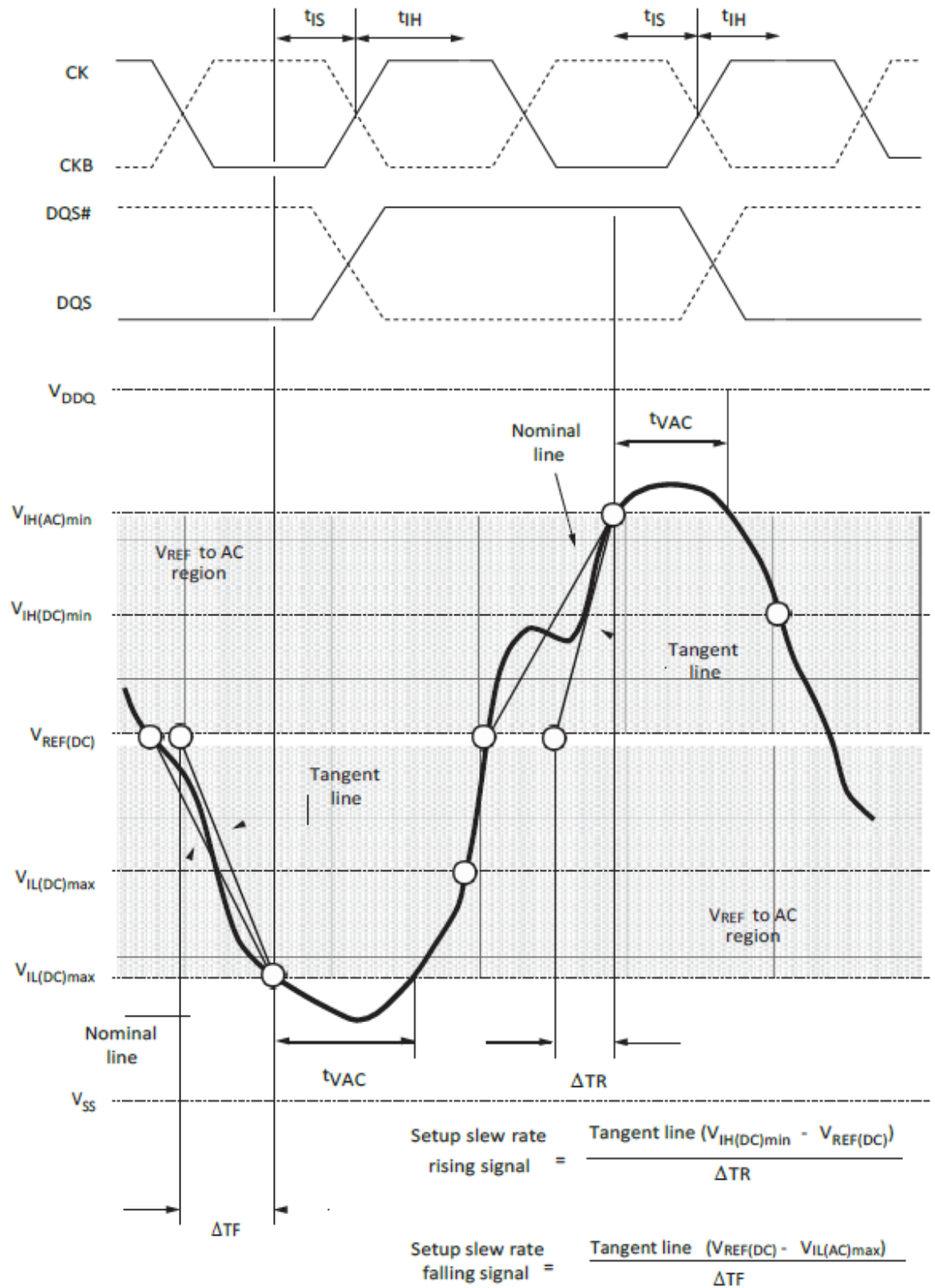

Note: 1. The clock and the strobe are drawn on different time scales.

**Tangent Line for  $t_{IH}$  (Command and Address – Clock)**

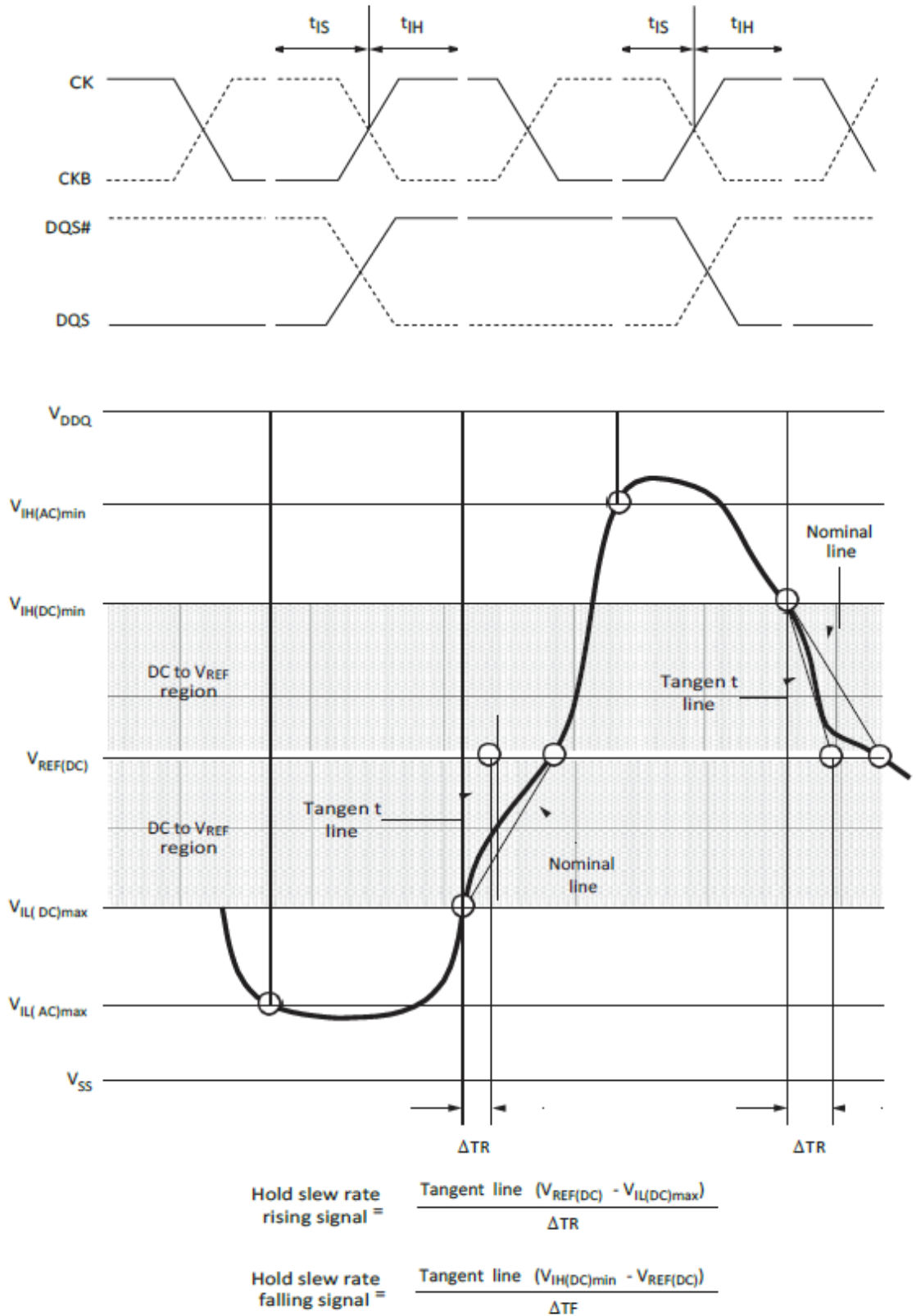

Note: 1. The clock and the strobe are drawn on different time scales.

## 11.2 Data Setup, Hold, and Derating

The total tDS(setup time) and tDH(hold time) required is calculated by adding the data sheet tDS(base) and tDH (base) values to the  $\Delta tDS$  and  $\Delta tDH$  derating values respectively. Example: tDS (total setup time) = tDS (base) +  $\Delta tDS$ . For a valid transition, the input signal has to remain above/below VIH(AC)/VIL(AC) for sometime Tvac. Although the total setup time for slow slew rates might be negative (for example, a valid input signal will not have reached VIH(AC)/VIL(AC)) at the time of the rising clock transition, a valid input signal is still required to complete the transition and to reach VIH/VIL(AC). For slew rates that fall between the values listed, the derating values may be obtained by linear interpolation. Setup(tDS) nominal slew rate for a rising signal is defined as the slew rate between the last crossing of VREF(DC) and the first crossing of VIH(AC)min. Setup(tDS) nominal slew rate for a falling signal is defined as the slew rate between the last crossing of VREF(DC) and the first crossing of VIL(AC)max. If the actual signal is always earlier than the nominal slew rate line between the shaded VREF(DC)-to-AC region, use the nominal slew rate for derating value. If the actual signal is later than the nominal slew rate line anywhere between the shaded VREF(DC)-to-AC region, the slew rate of a tangent line to the actual signal from the AC level to the DC level is used for derating value.

Hold(tDH) nominal slew rate for a rising signal is defined as the slew rate between the last crossing of VIL(DC)max and the first crossing of VREF(DC). Hold (tDH) nominal slew rate for a falling signal is defined as the slew rate between the last crossing of VIH(DC)min and the first crossing of VREF(DC). If the actual signal is always later than the nominal slew rate line between the shaded DC-to-VREF(DC) region, use the nominal slew rate for derating value. If the actual signal is earlier than the nominal slew rate line anywhere between the shaded DC-to-VREF(DC) region, the slew rate of a tangent line to the actual signal from the DC-to-VREF(DC) region is used for derating value.

### DDR3L Data Setup and Hold Values at 1 V/ns (DQS, DQS# at 2 V/ns) – AC/DC-Based

Symbol	1600	1866	2133	Unit	Reference
t <sup>DS</sup> (base) AC160	–	–	–	ps	V <sub>IH(AC)</sub> /V <sub>IL(AC)</sub>
t <sup>DS</sup> (base) AC135	25	–	–	ps	
t <sup>DS</sup> (base) AC130	–	70	55	ps	
t <sup>DH</sup> (base) DC90	55	–	–	ps	
t <sup>DH</sup> (base) DC90	–	75	60	ps	
Slew Rate Referenced	1	2	2	V/ns	



DDR3L Derating Values for  $t_{DS}/t_{DH}$  – AC160/DC90-Based

$\Delta t_{DS}, \Delta t_{DH}$ Derating (ps) – AC/DC-Based																
DQ Slew Rate V/ns	DQS, DQS# Differential Slew Rate															
	4.0 V/ns		3.0 V/ns		2.0 V/ns		1.8 V/ns		1.6 V/ns		1.4 V/ns		1.2 V/ns		1.0 V/ns	
	$\Delta t_{DS}$	$\Delta t_{DH}$	$\Delta t_{DS}$	$\Delta t_{DH}$	$\Delta t_{DS}$	$\Delta t_{DH}$	$\Delta t_{DS}$	$\Delta t_{DH}$	$\Delta t_{DS}$	$\Delta t_{DH}$	$\Delta t_{DS}$	$\Delta t_{DH}$	$\Delta t_{DS}$	$\Delta t_{DH}$	$\Delta t_{DS}$	$\Delta t_{DH}$
2.0	80	45	80	45	80	45										
1.5	53	30	53	30	53	30	61	38								
1.0	0	0	0	0	0	0	8	8	16	16						
0.9			-1	-3	-1	-3	7	5	15	13	23	21				
0.8					-3	-8	5	1	13	9	21	17	29	27		
0.7							-3	-5	11	3	19	11	27	21	35	37
0.6									8	-4	16	4	24	14	32	30
0.5											4	6	12	4	20	20
0.4													-8	-11	0	5

DDR3L Derating Values for  $t_{DS}/t_{DH}$  – AC135/DC90-Based

$\Delta t_{DS}, \Delta t_{DH}$ Derating (ps) – AC/DC-Based																
DQ Slew Rate V/ns	DQS, DQS# Differential Slew Rate															
	4.0 V/ns		3.0 V/ns		2.0 V/ns		1.8 V/ns		1.6 V/ns		1.4 V/ns		1.2 V/ns		1.0 V/ns	
	$\Delta t_{DS}$	$\Delta t_{DH}$	$\Delta t_{DS}$	$\Delta t_{DH}$	$\Delta t_{DS}$	$\Delta t_{DH}$	$\Delta t_{DS}$	$\Delta t_{DH}$	$\Delta t_{DS}$	$\Delta t_{DH}$	$\Delta t_{DS}$	$\Delta t_{DH}$	$\Delta t_{DS}$	$\Delta t_{DH}$	$\Delta t_{DS}$	$\Delta t_{DH}$
2.0	68	45	68	45	68	45										
1.5	45	30	45	30	45	30	53	38								
1.0	0	0	0	0	0	0	8	8	16	16						
0.9			2	-3	2	-3	10	5	18	13	26	21				
0.8					3	-8	11	1	19	9	27	17	35	27		
0.7							14	-5	22	3	30	11	38	21	46	37
0.6									25	-4	33	4	41	14	49	30
0.5											39	-6	37	4	45	20
0.4													30	-11	38	5





DDR3L Derating Values for  $t_{DS}/t_{DH}$  – AC130/DC90-Based at 2V/ns

Shaded cells indicate slew rate combinations not supported

$\Delta t_{DS}, \Delta t_{DH}$ Derating (ps) – AC/DC-Based																										
DQS, DQS# Differential Slew Rate																										
DQ Slew Rate V/ns	8.0 V/ns		7.0 V/ns		6.0 V/ns		5.0 V/ns		4.0 V/ns		3.0 V/ns		2.0 V/ns		1.8 V/ns		1.6 V/ns		1.4 V/ns		1.2 V/ns		1.0 V/ns			
	$\Delta t_{DS}$	$\Delta t_{DH}$	$\Delta t_{DS}$	$\Delta t_{DH}$	$\Delta t_{DS}$	$\Delta t_{DH}$	$\Delta t_{DS}$	$\Delta t_{DH}$	$\Delta t_{DS}$	$\Delta t_{DH}$	$\Delta t_{DS}$	$\Delta t_{DH}$	$\Delta t_{DS}$	$\Delta t_{DH}$	$\Delta t_{DS}$	$\Delta t_{DH}$	$\Delta t_{DS}$	$\Delta t_{DH}$	$\Delta t_{DS}$	$\Delta t_{DH}$	$\Delta t_{DS}$	$\Delta t_{DH}$	$\Delta t_{DS}$	$\Delta t_{DH}$		
	4.0	33	23	33	23	33	23																			
3.5	28	19	28	19	28	19	28	19																		
3.0	22	15	22	15	22	15	22	15	22	15																
2.5			13	9	13	9	13	9	13	9	13	9														
2.0					0	0	0	0	0	0	0	0	0	0												
1.5							-22	-15	-22	-15	-22	-15	-22	-15	-14	-7										
1.0									-65	-45	-65	-45	-65	-45	-57	-37	-49	-29								
0.9											-62	-48	-62	-48	-54	-40	-46	-32	-38	-24						
0.8													-61	-53	-53	-45	-45	-37	-37	-29	-29	-19				
0.7															-49	-50	-41	-42	-33	-34	-25	-24	-17	-8		
0.6																	-37	-49	-29	-41	-21	-31	-13	-15		
0.5																			-31	-51	-23	-41	-15	-25		
0.4																					-28	-56	-20	-40		

DDR3L Minimum Required Time  $t_{VAC}$  Above  $V_{IH(AC)}$  (Below  $V_{IL(AC)}$ ) for Valid DQ Transition

Slew Rate (V/ns)	DDR3L-1866/2133 130mV (ps) min
>2.0	95
2.0	95
1.5	73
1.0	30
0.9	16
0.8	Note 1
0.7	–
0.6	–
0.5	–
<0.5	–

Note: 1. Rising input signal shall become equal to or greater than  $V_{IH(AC)}$  level and Falling input signal shall become equal to or less than  $V_{IL(AC)}$  level.



**Nominal Slew Rate and  $t_{VAC}$  for  $t_{DS}$  (DQ – Strobe)**

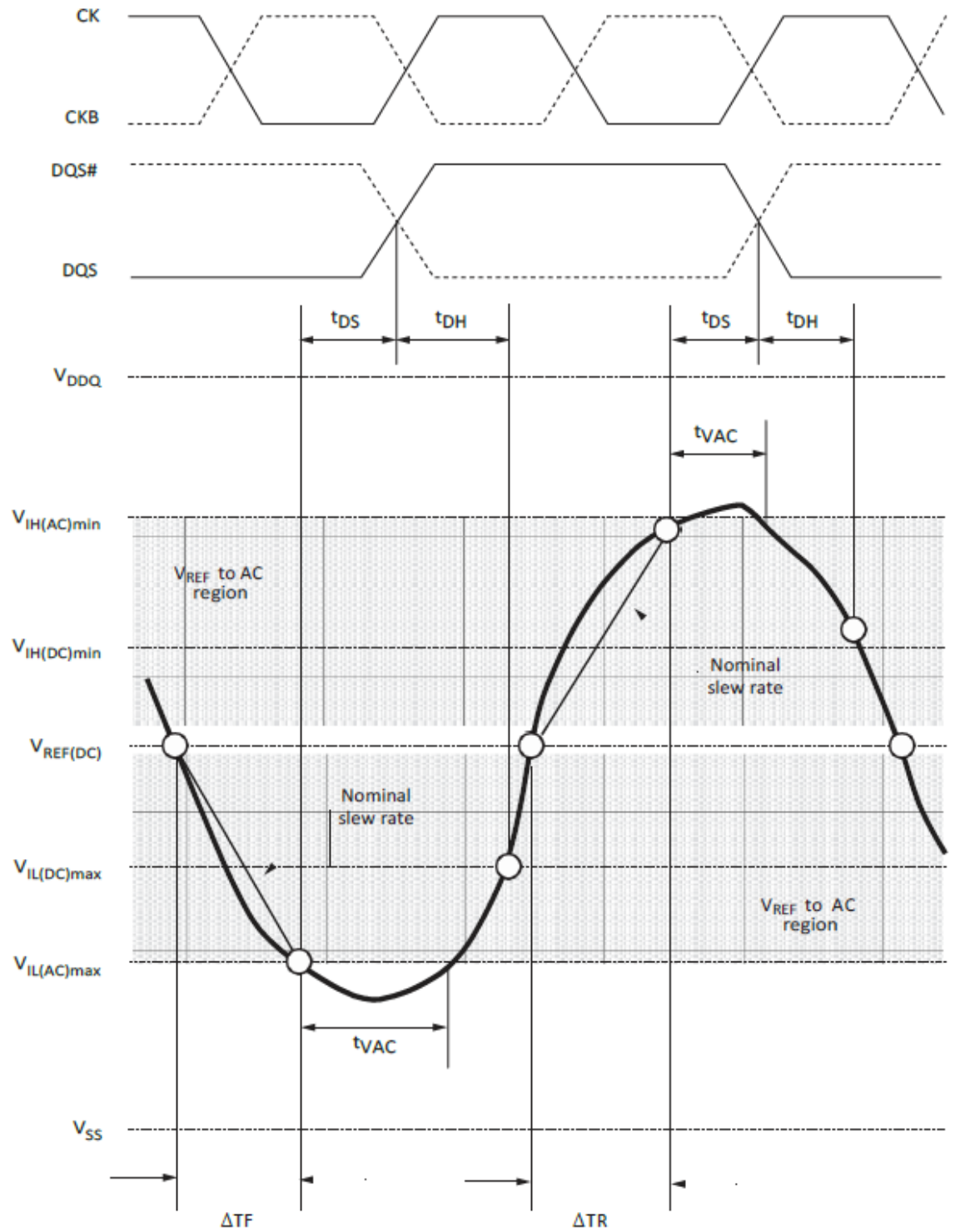

$$\text{Setup slew rate falling signal} = \frac{V_{REF(DC)} - V_{IL(AC)max}}{\Delta TF}$$

$$\text{Setup slew rate rising signal} = \frac{V_{IH(AC)min} - V_{REF(DC)}}{\Delta TR}$$

Note: 1. The clock and the strobe are drawn on different time scales.

**Nominal Slew Rate for  $t_{DH}$  (DQ – Strobe)**

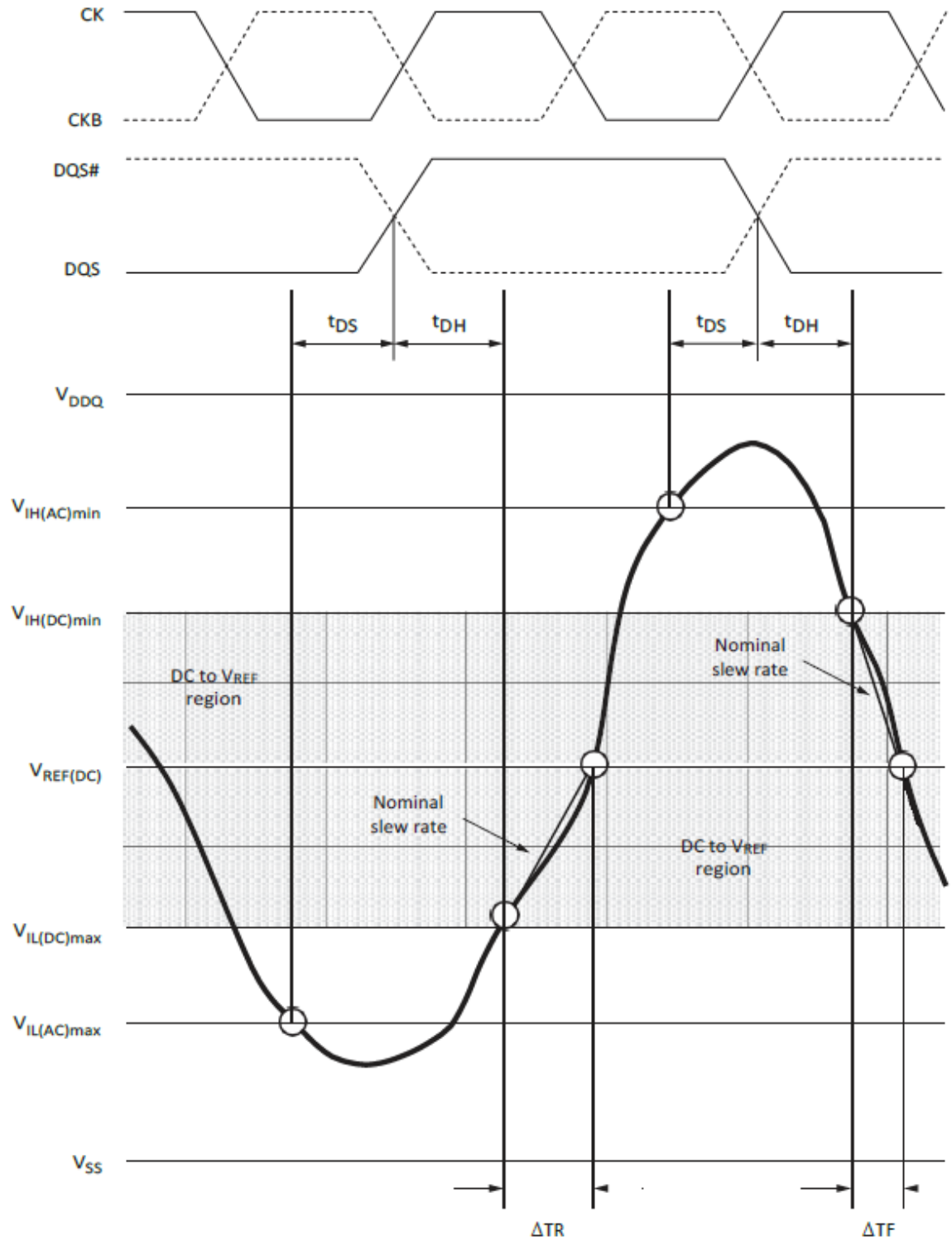

$$\text{Hold slew rate rising signal} = \frac{V_{REF(DC)} - V_{IL(DC)max}}{\Delta TR}$$

$$\text{Hold slew rate falling signal} = \frac{V_{IL(DC)min} - V_{REF(DC)}}{\Delta TF}$$

Note: 1. The clock and the strobe are drawn on different time scales.

**Tangent Line for  $t_{DS}$  (DQ – Strobe)**

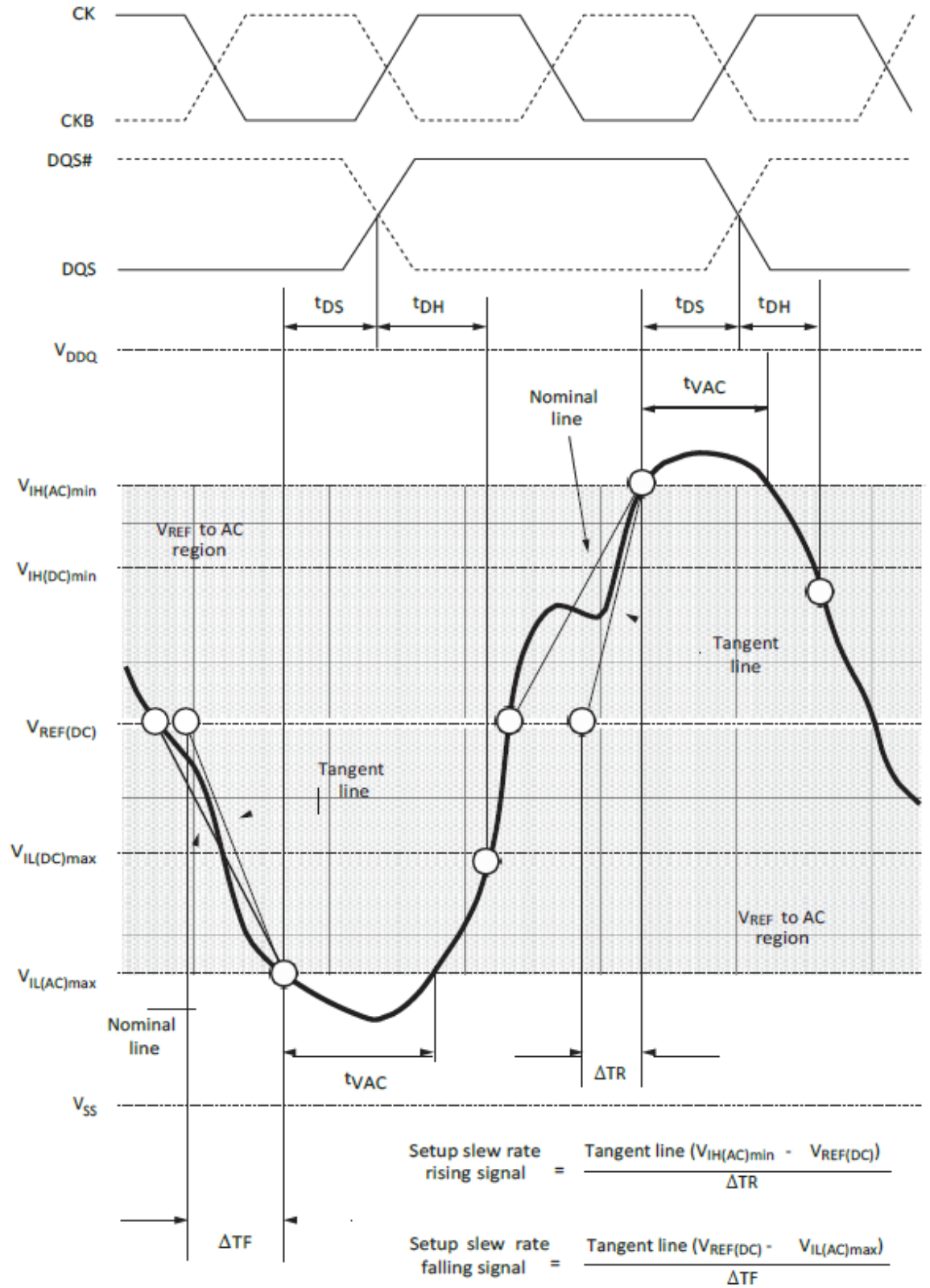

Note: 1. The clock and the strobe are drawn on different time scales.

**Tangent Line for  $t_{DH}$  (DQ – Strobe)**

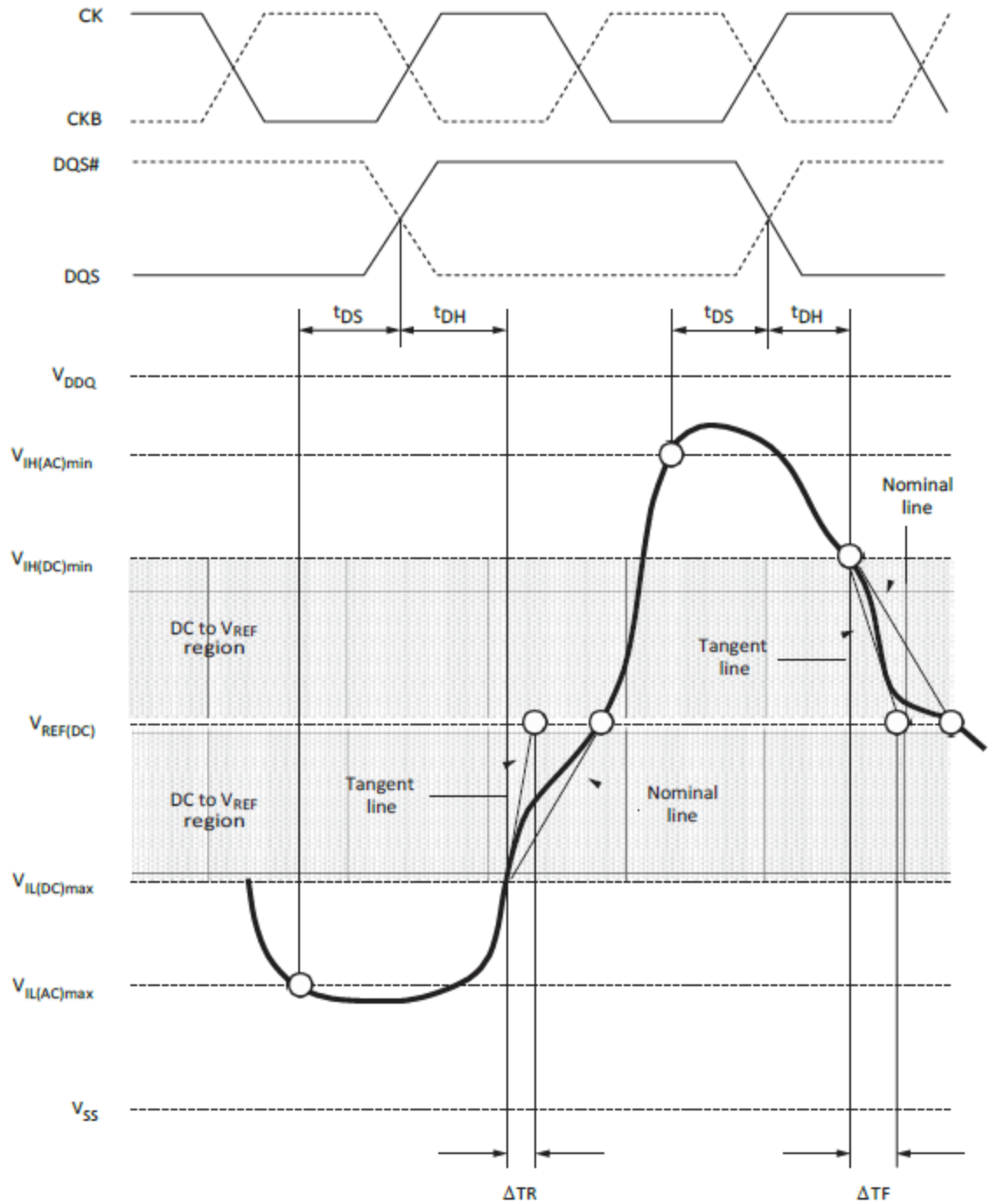

$$\text{Hold slew rate rising signal} = \frac{\text{Tangent line } (V_{REF(DC)} - V_{IL(DC)max})}{\Delta TR}$$

$$\text{Hold slew rate falling signal} = \frac{\text{Tangent line } (V_{IH(DC)min} - V_{REF(DC)})}{\Delta TF}$$

Note: 1. The clock and the strobe are drawn on different time scales.

## 12. Commands – Truth Tables

### Truth Table – Command

Notes 1–5 apply to the entire table

Function	Symbol	CKE		CSB	RASB	CASB	WEB	BA [2:0]	An	A12	A10	A[11, 9:0]	Notes	
		Prev. Cycle	Next Cycle											
MODE REGISTER SET	MRS	H	H	L	L	L	L	BA	OP code					
REFRESH	REF	H	H	L	L	L	H	V	V	V	V	V		
Self refresh entry	SRE	H	L	L	L	L	H	V	V	V	V	V	6	
Self refresh exit	SRX	L	H	H	V	V	V	V	V	V	V	V	6, 7	
				L	H	H	H							
Single-bank PRECHARGE	PRE	H	H	L	L	H	L	BA	V	V	L	V		
PRECHARGE all banks	PREA	H	H	L	L	H	L	V		V	H	V		
Bank ACTIVATE	ACT	H	H	L	L	H	H	BA	Row address (RA)					
WRITE	BL8MRS, BC4MRS	WR	H	H	L	H	L	L	BA	RFU	V	L	CA	8
	BC4OTF	WRS4	H	H	L	H	L	L	BA	RFU	L	L	CA	8
	BL8OTF	WRS8	H	H	L	H	L	L	BA	RFU	H	L	CA	8
WRITE with auto precharge	BL8MRS, BC4MRS	WRAP	H	H	L	H	L	L	BA	RFU	V	H	CA	8
	BC4OTF	WRAPS4	H	H	L	H	L	L	BA	RFU	L	H	CA	8
	BL8OTF	WRAPS8	H	H	L	H	L	L	BA	RFU	H	H	CA	8
READ	BL8MRS, BC4MRS	RD	H	H	L	H	L	H	BA	RFU	V	L	CA	8
	BC4OTF	RDS4	H	H	L	H	L	H	BA	RFU	L	L	CA	8
	BL8OTF	RDS8	H	H	L	H	L	H	BA	RFU	H	L	CA	8
READ with auto precharge	BL8MRS, BC4MRS	RDAP	H	H	L	H	L	H	BA	RFU	V	H	CA	8
	BC4OTF	RDAPS4	H	H	L	H	L	H	BA	RFU	L	H	CA	8
	BL8OTF	RDAPS8	H	H	L	H	L	H	BA	RFU	H	H	CA	8
NO OPERATION	NOP	H	H	L	H	H	H	V	V	V	V	V	9	
Device Deselected	DES	H	H	H	X	X	X	X	X	X	X	X	10	
Power-down entry	PDE	H	L	L	H	H	H	V	V	V	V	V	6	
				H	V	V	V							
Power-down exit	PDX	L	H	L	H	H	H	V	V	V	V	V	6, 11	
				H	V	V	V							
ZQ CALIBRATION LONG	ZQCL	H	H	L	H	H	L	X	X	X	H	X	12	
ZQ CALIBRATION SHORT	ZQCS	H	H	L	H	H	L	X	X	X	L	X		



- Notes:
- 1 Commands are defined by the states of CSB, RASB, CASB, WEB, and CKE at the rising edge of the clock. The MSB of BA, RA, and CA are device-, density-, and configuration dependent.
  - 2 RESETB is enabled LOW and used only for asynchronous reset. Thus, RESETB must be held HIGH during any normal operation.
  - 3 The state of ODT does not affect the states described in this table.
  - 4 Operations apply to the bank defined by the bank address. For MRS, BA selects one of four mode registers.
  - 5 "V" means "H" or "L" (a defined logic level), and "X" means "Don't Care."
  - 6 Additional information on CKE transition.
  - 7 Self refresh exit is asynchronous.
  - 8 Burst READs or WRITEs cannot be terminated or interrupted. MRS (fixed) and OTF BL/BC are defined in MR0.
  - 9 The purpose of the NOP command is to prevent the DRAM from registering any unwanted commands. A NOP will not terminate an operation that is executing.
  - 10 The DES and NOP commands perform similarly.
  - 11 The power-down mode does not perform any REFRESH operations.
  - 12 ZQ CALIBRATION LONG is used for either ZQinit (first ZQCL command during initialization) or ZQoper (ZQCL command after initialization).

**Truth Table – CKE**

Notes 1–2 apply to the entire table; for additional command details

Current State <sup>3</sup>	CKE		Command <sup>5</sup> (RASB, CASB, WEB,	Action <sup>5</sup>	Notes
	Previous Cycle <sup>4</sup> ( <i>n</i> - 1)	Present Cycle <sup>4</sup> ( <i>n</i> )			
Power-down	L	L	"Don't Care"	Maintain power-down	
	L	H	DES or NOP	Power-down exit	
Self refresh	L	L	"Don't Care"	Maintain self refresh	
	L	H	DES or NOP	Self refresh exit	
Bank(s) active	H	L	DES or NOP	Active power-down entry	
Reading	H	L	DES or NOP	Power-down entry	
Writing	H	L	DES or NOP	Power-down entry	
Precharging	H	L	DES or NOP	Power-down entry	
Refreshing	H	L	DES or NOP	Precharge power-down entry	
All banks idle	H	L	DES or NOP	Precharge power-down entry	6
	H	L	REFRESH	Self refresh	

- Notes:
- 1 All states and sequences not shown are illegal or reserved unless explicitly described elsewhere in this document.
  - 2 tCKE (MIN) means CKE must be registered at multiple consecutive positive clock edges. CKE must remain at the valid input level the entire time it takes to achieve the required number of registration clocks. Thus, after any CKE transition, CKE may not transition from its valid level during the time period of tIS + tCKE (MIN) + tIH.
  - 3 Current state = The state of the DRAM immediately prior to clock edge *n*.
  - 4 CKE (*n*) is the logic state of CKE at clock edge *n*; CKE (*n* - 1) was the state of CKE at the previous clock edge.
  - 5 COMMAND is the command registered at the clock edge. Action is a result of



- 6 COMMAND. ODT does not affect the states described in this table and is not listed.  
Idle state = All banks are closed, no data bursts are in progress, CKE is HIGH, and all timings from previous operations are satisfied. All self refresh exit and power-down exit parameters are also satisfied.

### Commands

<b>DESELECT</b>	
	The DESELT (DES) command (CSB HIGH) prevents new commands from being executed by the DRAM. Operations already in progress are not affected.
<b>NOOPERATION</b>	
	The NO OPERATION (NOP) command (CSB LOW) prevents unwanted commands from being registered during idle or wait states. Operations already in progress are not affected.
<b>ZQ CALIBRATION LONG</b>	
	The ZQ CALIBRATION LONG (ZQCL) command is used to perform the initial calibration during a power-up initialization and reset sequence. This command may be issued at any time by the controller, depending on the system environment. The ZQCL command triggers the calibration engine inside the DRAM. After calibration is achieved, the calibrated values are transferred from the calibration engine to the DRAM I/O, which are reflected as updated $R_{ON}$ and ODT values. The DRAM is allowed a timing window defined by either $t_{ZQinit}$ or $t_{ZQoper}$ to perform a full calibration and transfer of values. When ZQCL is issued during the initialization sequence, the timing parameter $t_{ZQinit}$ must be satisfied. When initialization is complete, subsequent ZQCL commands require the timing parameter $t_{ZQoper}$ to be satisfied.
<b>ZQ CALIBRATION SHORT</b>	
	The ZQCALIBRATION SHORT(ZQCS) command is used to perform periodic calibrations to account for small voltage and temperature variations. A shorter timing window is provided to perform the reduced calibration and transfer of values as defined by timing parameter $t_{ZQCS}$ . A ZQCS command can effectively correct a minimum of 0.5% $R_{ON}$ and $R_{TT}$ impedance error within 64 clock cycles, assuming the maximum sensitivities specified in DDR3L 34 Ohm Output Driver Sensitivity.
<b>ACTIVATE</b>	
	The ACTIVATE command is used to open (or activate) a row in a particular bank for a subsequent access. The value on the BA[2:0] inputs selects the bank, and the address provided on inputs A[n:0] selects the row. This row remains open (or active) for accesses until a PRECHARGE command is issued to that bank. A PRECHARGE command must be issued before opening a different row in the same bank.
<b>READ</b>	The READ command is used to initiate a burst read access to an active row. The address provided on inputs A[2:0] selects the starting column address,





depending on the burst length and burst type selected (see Burst Order table for additional information). The value on input A10 determines whether auto precharge is used. If auto precharge is selected, the row being accessed will be precharged at the end of the READ burst. If auto precharge is not selected, the row will remain open for subsequent accesses. The value on input A12 (if enabled in the mode register) when the READ command is issued determines whether BC4 (chop) or BL8 is used. After a READ command is issued, the READ burst may not be interrupted.

**READ Command Summary**

Function		Symbol	CKE		CSB	RASB	CASB	WEB	BA [2:0]	A11	A12	A10	A[11, 9:0]
			Prev. Cycle	Next Cycle									
READ	BL8MRS, BC4MRS	RD	H		L	H	L	H	BA	RFU	V	L	CA
	BC4OTF	RDS4	H		L	H	L	H	BA	RFU	L	L	CA
	BL8OTF	RDS8	H		L	H	L	H	BA	RFU	H	L	CA
READ with auto precharge	BL8MRS, BC4MRS	RDAP	H		L	H	L	H	BA	RFU	V	H	CA
	BC4OTF	RDAPS4	H		L	H	L	H	BA	RFU	L	H	CA
	BL8OTF	RDAPS8	H		L	H	L	H	BA	RFU	H	H	CA

**WRITE**

The WRITE command is used to initiate a burst write access to an active row. The value on the BA[2:0] inputs selects the bank. The value on input A10 determines whether auto precharge is used. The value on input A12 (if enabled in the MR) when the WRITE command is issued determines whether BC4 (chop) or BL8 is used.

Input data appearing on the DQ is written to the memory array subject to the DM input logic level appearing coincident with the data. If a given DM signal is registered LOW, the corresponding data will be written to memory. If the DM signal is registered HIGH, the corresponding data inputs will be ignoring and a WRITE will not be executed to that byte/column location.



**WRITE Command Summary**

Function		Symbol	CKE		CSB	RASB	CASB	WEB	BA [2:0]	A/I	A12	A10	A[11, 9:0]
			Prev. Cycle	Next Cycle									
WRITE	BL8MRS, BC4MRS	WR	H		L	H	L	L	BA	RFU	V	L	CA
	BC4OTF	WRS4	H		L	H	L	L	BA	RFU	L	L	CA
	BL8OTF	WRS8	H		L	H	L	L	BA	RFU	H	L	CA
WRITE with auto precharge	BL8MRS, BC4MRS	WRAP	H		L	H	L	L	BA	RFU	V	H	CA
	BC4OTF	WRAPS4	H		L	H	L	L	BA	RFU	L	H	CA
	BL8OTF	WRAPS8	H		L	H	L	L	BA	RFU	H	H	CA

**PRECHARGE**

The PRECHARGE command is used to de-activate the open row in a particular bank or in all banks. The bank(s) are available for a subsequent row access a specified time (tRP) after the PRECHARGE command is issued, except in the case of concurrent auto precharge. A READ or WRITE command to a different bank is allowed during a concurrent auto precharge as long as it does not interrupt the data transfer in the current bank and does not violate any other timing parameters. Input A10 determines whether one or all banks are precharged. In the case where only one bank is precharged, inputs BA[2:0] select the bank; otherwise, BA[2:0] are treated as “Don’t Care.”

After a bank is precharged, it is in the idle state and must be activated prior to any READ or WRITE commands being issued to that bank. A PRECHARGE command is treated as a NOP if there is no open row in that bank (idle state) or if the previously open row is already in the process of precharging. However, the precharge period is determined by the last PRECHARGE command issued to the bank.

**REFRESH**

The REFRESH command is used during normal operation of the DRAM and is analogous to CASB-before-RASB (CBR) refresh or auto refresh. This command is nonpersistent, so it must be issued each time a refresh is required. The addressing is generated by the



internal refresh controller. This makes the address bits a “Don’t Care” during a REFRESH command. The DRAM requires REFRESH cycles at an average interval of  $7.8\mu\text{s}$  (maximum when  $TC \leq 85^\circ\text{C}$  or  $3.9\mu\text{s}$  maximum when  $TC \leq 95^\circ\text{C}$ ). The REFRESH period begins when the REFRESH command is registered and ends  $t\text{RFC}(\text{MIN})$  later.

To allow for improved efficiency in scheduling and switching between tasks, some flexibility in the absolute refresh interval is provided. A maximum of eight REFRESH commands can be posted to any given DRAM, meaning that the maximum absolute interval between any REFRESH command and the next REFRESH command is nine times the maximum average interval refresh rate. Self refresh may be entered with up to eight REFRESH commands being posted. After exiting self refresh (when entered with posted REFRESH commands), additional posting of REFRESH commands is allowed to the extent that the maximum number of cumulative posted REFRESH commands (both pre and post-self refresh) does not exceed eight REFRESH commands.

At any given time, a maximum of 16 REFRESH commands can be issued within  $2x t\text{REFI}$ .



### Refresh Mode

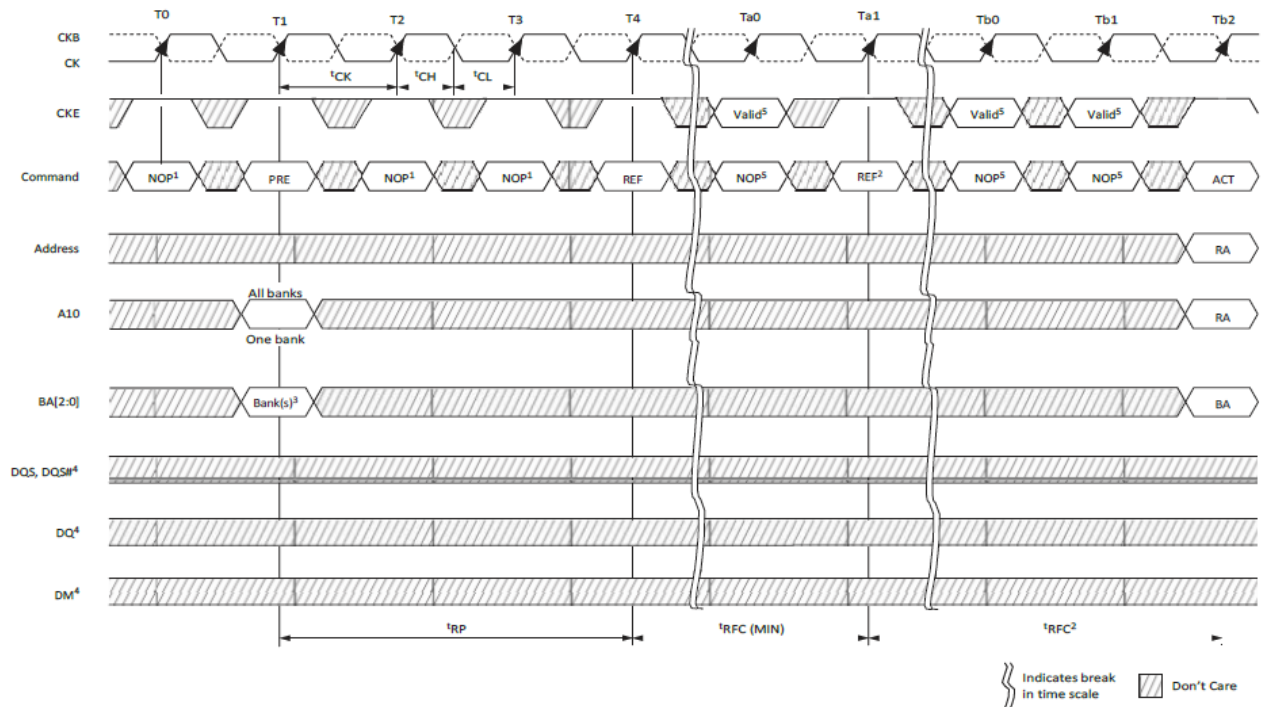

- Notes
- 1 NOP commands are shown for ease of illustration; other valid commands may be possible at these times. CKE must be active during the PRECHARGE, ACTIVATE, and REFRESH commands, but may be inactive at other times (see Power-Down Mode..
  - 2 The second REFRESH is not required, but two back-to-back REFRESH commands are shown.
  - 3 “Don’t Care” if A10 is HIGH at this point; however, A10 must be HIGH if more than one bank is active (must precharge all active banks).
  - 4 For operations shown, DM, DQ, and DQS signals are all “Don’t Care”/High-Z.
  - 5 Only NOP and DES commands are allowed after a REFRESH command and until tRFC (MIN) is satisfied.



## SELF REFRESH

The SELF REFRESH command is used to retain data in the DRAM, even if the rest of the system is powered down. When in self refresh mode, the DRAM retains data without external clocking. Self refresh mode is also a convenient method used to enable/disable the DLL as well as to change the clock frequency within the allowed synchronous operating range (see Input Clock Frequency Change. All power supply inputs (including VREFCA and VREFDQ) must be maintained at valid levels upon entry/exit and during self refresh mode operation. VREFDQ may float or not drive VDDQ/2 while in self refresh mode under the following conditions:

- $V_{SS} < V_{REFDQ} < V_{DD}$  is maintained
- VREFDQ is valid and stable prior to CKE going back HIGH
- The first WRITE operation may not occur earlier than 512 clocks after VREFDQ is valid
- All other self refresh mode exit timing requirements are met

## DLL Disable Mode

If the DLL is disabled by the mode register (MR1[0] can be switched during initialization or later), the DRAM is targeted, but not guaranteed, to operate similarly to the normal mode, with a few notable exceptions:

- The DRAM supports only one value of CAS latency (CL=6) and one value of CAS WRITE latency (CWL = 6).
- DLL disable mode affects the read data clock-to-data strobe relationship (tDQSCK), but not the read data-to-data strobe relationship (tDQSQ, tQH). Special attention is required to line up the read data with the controller time domain when the DLL is disabled.
- In normal operation (DLLon), tDQSCK starts from the rising clock edge AL+ CL cycles after the READ command. In DLL disable mode, tDQSCK starts AL+CL-1 cycles after the READ command. Additionally, with the DLL disabled, the value of tDQSCK could be larger than tCK.

The ODT feature (including dynamic ODT) is not supported during DLL disable mode. The ODT resistors must be disabled by continuously registering the ODT ball LOW by programming RTT,nom MR1[9,6,2] and RTT(WR) MR2[10,9] to 0 while in the DLL disable mode.

Specific steps must be followed to switch between the DLL enable and DLL disable modes due to a gap in the allowed clock rates between the two modes (tCK[AVG] MAX and tCK[DLL\_DIS] MIN, respectively). The only time the clock is allowed to cross this clock rate gap is during self refresh mode. Thus, the required procedure for switching from the DLL enable mode to the DLL



disable mode is to change frequency during self refresh:

1. Starting from the idle state (all banks are precharged, all timings are fulfilled, ODT is turned off, and  $RTT_{nom}$  and  $RTT(WR)$  are High-Z), set  $MR1[0]$  to 1 to disable the DLL.
2. Enter self refresh mode after  $t_{MOD}$  has been satisfied.
3. After  $t_{CKSRE}$  is satisfied, change the frequency to the desired clock rate.
4. Self refresh maybe exited when the clock is stable with the new frequency for  $t_{CKSRX}$ . After  $t_{XS}$  is satisfied, update the mode registers with appropriate values.
5. The DRAM will be ready for its next command in the DLL disable mode after the greater of  $t_{MRD}$  or  $t_{MOD}$  has been satisfied. AZQCL command should be issued with appropriate timings met.

#### DLL Enable Mode to DLL Disable Mode

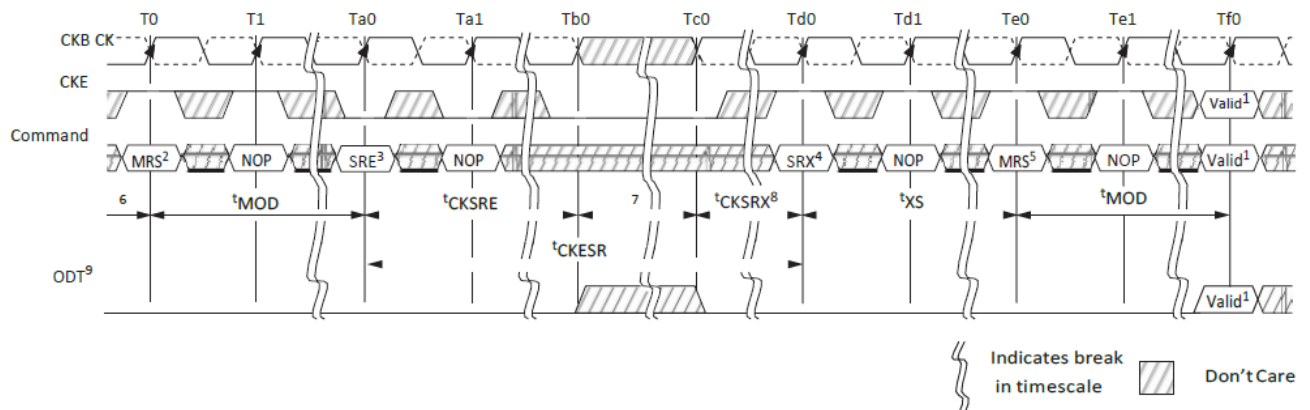

- Notes:
- 1 Any valid command.
  - 2 Disable DLL by setting  $MR1[0]$  to 1
  - 3 Enter SELFREFRESH.
  - 4 Exit SELFREFRESH.
  - 5 Update the mode registers with the DLL disable parameters setting.
  - 6 Starting with the idle state,  $RTT$  is in the High-Z state.
  - 7 Change frequency.
  - 8 Clock must be stable  $t_{CKSRX}$ .
  - 9 Static LOW in the case that  $RTT_{nom}$  or  $RTT(WR)$  is enabled; otherwise, static LOW or HIGH.

A similar procedure is required for switching from the DLL disable mode back to the DLL enable mode. This also requires changing the frequency during self refresh mode. Starting from the idle state (all banks are precharged, all timings are fulfilled, ODT is turned off, and  $RTT_{nom}$  and  $RTT(WR)$  are High-Z), enter self refresh mode.



1. After  $t_{CKSRE}$  is satisfied, change the frequency to the new clock rate.
2. Self refresh may be exited when the clock is stable with the new frequency for  $t_{CKSRX}$ . After  $t_{XS}$  is satisfied, update the mode registers with the appropriate values. At a minimum, set  $MR1[0]$  to 0 to enable the DLL. Wait  $t_{MRD}$ , then set  $MR0[8]$  to 1 to enable DLL RESET.
3. After another  $t_{MRD}$  delay is satisfied, update the remaining mode registers with the appropriate values.
4. The DRAM will be ready for its next command in the DLL enable mode after the greater of  $t_{MRD}$  or  $t_{MOD}$  has been satisfied. However, before applying any command or function requiring a locked DLL, a delay of  $t_{DLLK}$  after DLL RESET must be satisfied. A ZQCL command should be issued with the appropriate timings met.

#### DLL Disable Mode to DLL Enable Mode

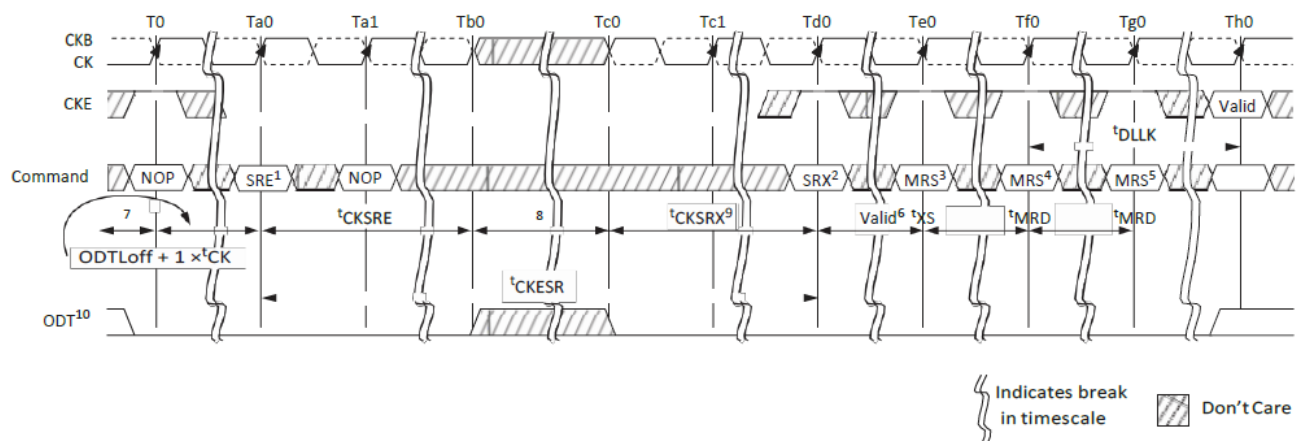

- Notes:
- 1 Enter SELF REFRESH.
  - 2 Exit SELFREFRESH.
  - 3 Wait  $t_{XS}$ , then set  $MR1[0]$  to 0 to enable DLL.
  - 4 Wait  $t_{MRD}$ , then set  $MR0[8]$  to 1 to begin DLL RESET.
  - 5 Wait  $t_{MRD}$ , update registers (CL, CWL, and write recovery may be necessary).
  - 6 Wait  $t_{MOD}$ , any valid command.
  - 7 Starting with the idle state.
  - 8 Change frequency
  - 9 Clock must be stable at least  $t_{CKSRX}$ .
  - 10 Static LOW in the case that  $RTT_{nom}$  or  $RTT(WR)$  is enabled; otherwise, static LOW or HIGH.  
The clock frequency range for the DLL disable mode is specified by the parameter  $t_{CK}$  (DLL\_DIS). Due to latency counter and timing restrictions, only CL=6 and CWL=6 are supported.

DLL disable mode will affect the read data clock to data strobe



relationship( $t_{DQSK}$ ) but not the data strobe to data relationship ( $t_{DQSQ}$ ,  $t_{QH}$ ). Special attention is needed to line up read data to the controller time domain.

Compared to the DLL on mode where  $t_{DQSK}$  starts from the rising clock edge  $AL+CL$  cycles after the READ command, the DLL disable mode  $t_{DQSK}$  starts  $AL+CL - 1$  cycles after the READ command.

WRITE operations function similarly between the DLL enable and DLL disable modes; however, ODT functionality is not allowed with DLL disable mode.

### DLL Disable $t_{DQSK}$

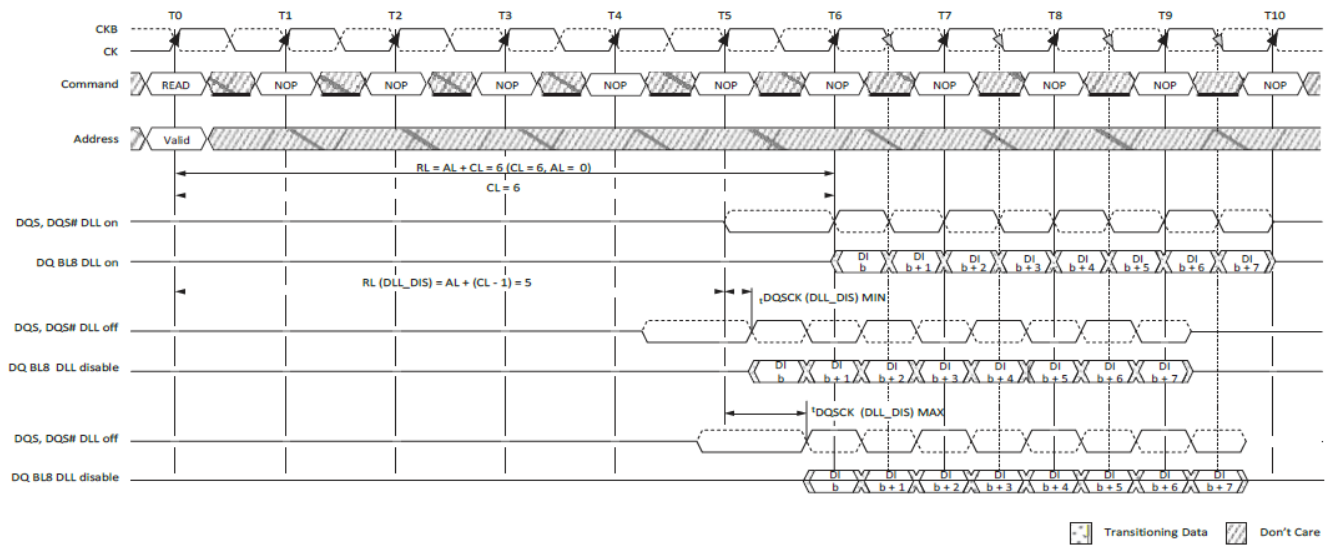

### READ Electrical Characteristics, DLL Disable Mode

Parameter	Symbol	Min	Max	Unit
Access window of DQS from CK, CKB	$t_{DQSK} (DLL\_DIS)$	1	10	ns





### 13. Input Clock Frequency Change

When the DDR3 SDRAM is initialized, the clock must be stable during most normal states of operation. This means that after the clock frequency has been set to the stable state, the clock period is not allowed to deviate, except for what is allowed by the clock jitter and spread spectrum clocking (SSC) specifications. The input clock frequency can be changed from one stable clock rate to another under two conditions: self refresh mode and precharge power-down mode. It is illegal to change the clock frequency outside of those two modes. For the self refresh mode condition, when the DDR3 SDRAM has been successfully placed into self refresh mode and  $t_{CKSRE}$  has been satisfied, the state of the clock becomes a "Don't Care." When the clock becomes a "Don't Care," changing the clock frequency is permissible if the new clock frequency is stable prior to  $t_{CKSRX}$ . When entering and exiting self refresh mode for the sole purpose of changing the clock frequency, the self refresh entry and exit specifications must still be met.

The precharge power-down mode condition is when the DDR3 SDRAM is in precharge power-down mode (either fast exit mode or slow exit mode). Either ODT must be at a logic LOW or  $RTT_{nom}$  and  $RTT(WR)$  must be disabled via MR1 and MR2.

This ensures  $RTT_{nom}$  and  $RTT(WR)$  are in an off state prior to entering precharge power-down mode, and CKE must be at a logic LOW. A minimum of  $t_{CKSRE}$  must occur after CKE goes LOW before the clock frequency can change. The DDR3 SDRAM input clock frequency is allowed to change only within the minimum and maximum operating frequency specified for the particular speed grade ( $t_{CK[AVG] MIN}$  to  $t_{CK[AVG] MAX}$ ). During the input clock frequency change, CKE must be held at a stable LOW level. When the input clock frequency is changed, a stable clock must be provided to the DRAM  $t_{CKSRX}$  before pre-charge power-down may be exited. After precharge power-down is exited and  $t_{XP}$  has been satisfied, the DLL must be reset via the MRS. Depending on the new clock frequency, additional MRS commands may need to be issued. During the DLL lock time,  $RTT_{nom}$  and  $RTT(WR)$  must remain in an off state. After the DLL lock time, the DRAM is ready to operate with a new clock frequency.



### Change Frequency During Precharge Power-Down

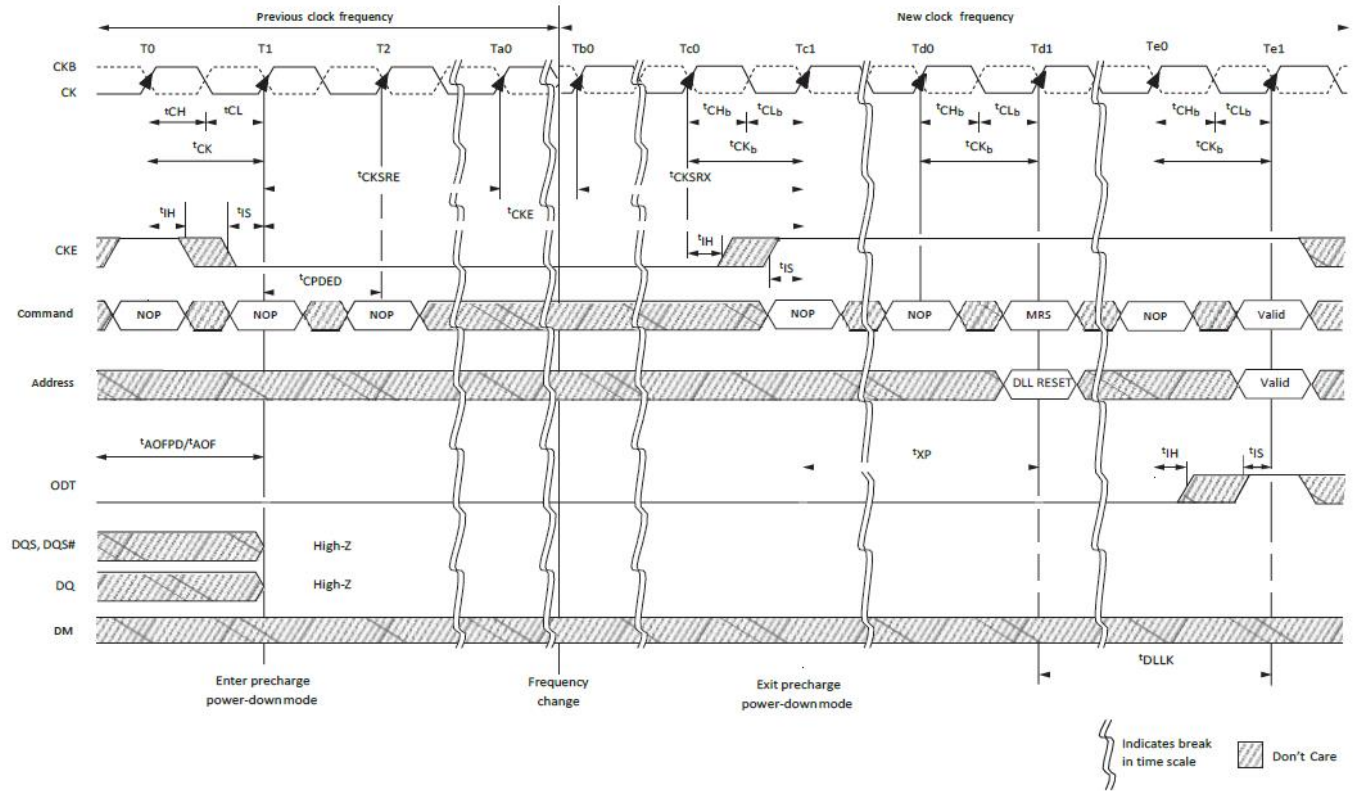

- Notes:
- 1 Applicable for both SLOW-EXIT and FAST-EXIT precharge power-down modes.
  - 2  $t_{AOFPD}$  and  $t_{AOF}$  must be satisfied and outputs High-Z prior to T1 (see On-Die Termination (ODT) for exact requirements).
  - 3 If the  $RTT_{nom}$  feature was enabled in the mode register prior to entering precharge power-down mode, the ODT signal must be continuously registered LOW, ensuring  $RTT$  is in an off state. If the  $RTT_{nom}$  feature was disabled in the mode register prior to entering precharge power-down mode,  $RTT$  will remain in the off state. The ODT signal can be registered LOW or HIGH in this case.



## 14. Write Leveling

For better signal integrity, DDR3 SDRAM memory modules have adopted fly-by topology for the commands, addresses, control signals, and clocks. Write leveling is a scheme for the memory controller to adjust or de-skew the DQS strobe (DQS,DQS#) to CK relationship at the DRAM with a simple feedback feature provided by the DRAM.

Write leveling is generally used as part of the initialization process, if required. For normal DRAM operation, this feature must be disabled. This is the only DRAM operation where the DQS functions as an input (to capture the incoming clock) and the DQ function as outputs (to report the state of the clock). Note that nonstandard ODT schemes are re-quired.

The memory controller using the write leveling procedure must have adjustable delay settings on its DQS strobe to align the rising edge of DQS to the clock at the DRAM pins. This is accomplished when the DRAM asynchronously feeds back the CK status via the DQ bus and samples with the rising edge of DQS. The controller repeatedly delays the DQS strobe until a CK transition from 0 to 1 is detected. The DQS delay established by this procedure helps ensure tDQSS, tDSS, and tDSH specifications in systems that use fly-by topology by de-skewing the trace length mismatch. A conceptual timing of this procedure is shown.



**Write Leveling Concept**

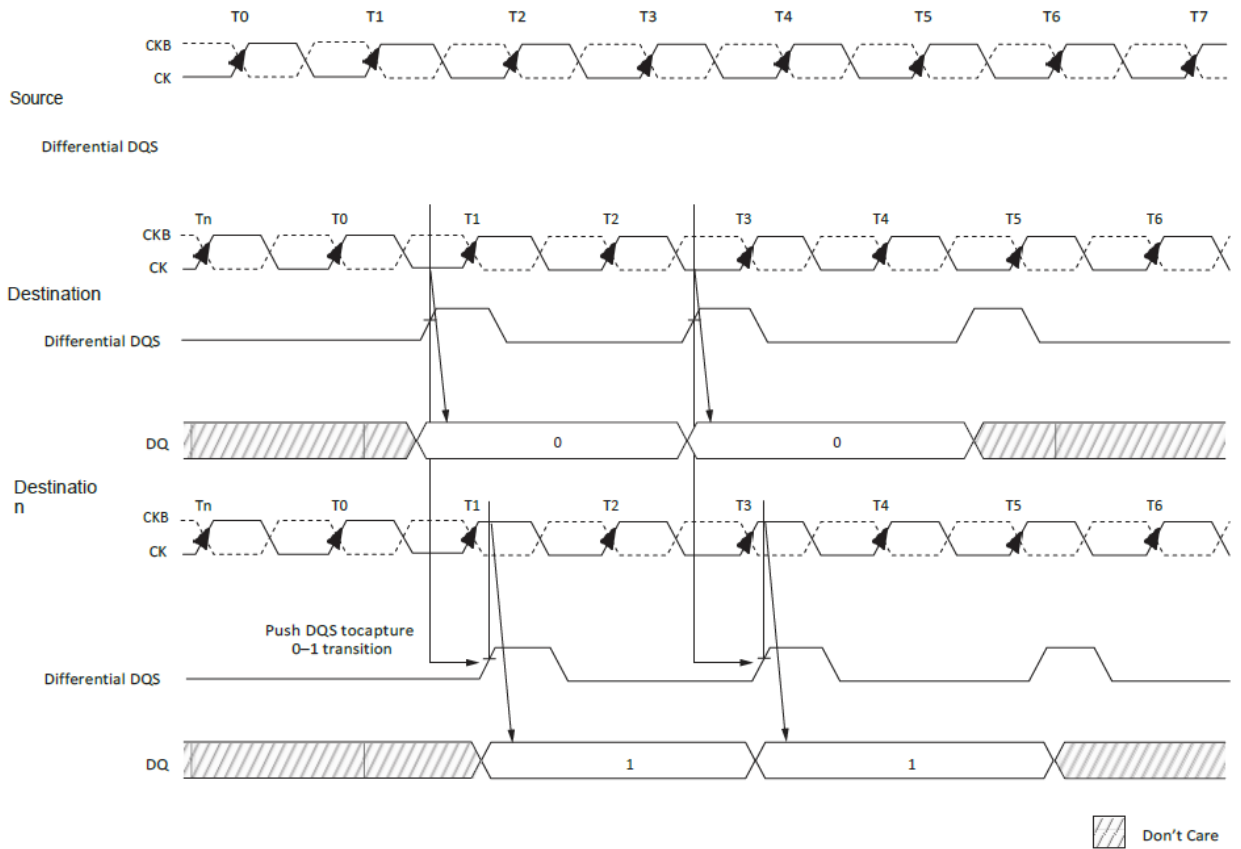

When write leveling is enabled, the rising edge of DQS samples CK, and the prime DQ outputs the sampled CK's status. The prime DQ for a x4 or x8 configuration is DQ0 with

all other DQ(DQ[7:1]) driving LOW. The prime DQ for a x16 configuration is DQ0 for the lower byte and DQ8 for the upper byte. It outputs the status of CK sampled by LDQS and UDQS. All other DQ(DQ[7:1], DQ[15:9]) continue to drive LOW. Two prime DQ on a x16 enable each byte lane to be leveled independently.

The write leveling mode register interacts with other mode registers to correctly configure the write leveling functionality. Besides using MR1[7] to disable/enable write leveling, MR1[12] must be used to enable/disable the output buffers. The ODT value, burst length, and so forth need to be selected as well. This interaction is shown in Table 75. It should also be noted that when the outputs are enabled during write leveling mode, the DQS buffers are set as inputs, and the DQ are set as outputs. Additionally, during write leveling mode, only the DQS strobe terminations are activated and deactivated via the ODT ball. The DQ remain disabled and are not affected by the ODT ball.



**Write Leveling Matrix**

Note 1 applies to the entire table

MR1[7]	MR1[12]	MR1[2, 6, 9]	DRAM ODT Ball	DRAM R <sub>TT,nom</sub>		DRAM State	Case	Notes
				DQS	DQ			
Disabled	See normal operations					Write leveling not enabled	0	
Enabled (1)	Disabled (1)	n/a	Low	Off	Off	DQS not receiving: not terminated Prime DQ High-Z: not terminated Other DQ High-Z: not terminated	1	2
		20Ω, 30Ω, 40Ω, 60Ω, or 120Ω	High	On		DQS not receiving: terminated by R <sub>TT</sub> Prime DQ High-Z: not terminated Other DQ High-Z: not terminated	2	
	Enabled (0)	n/a	Low	Off		DQS receiving: not terminated Prime DQ driving CK state: not terminated Other DQ driving LOW: not terminated	3	3
		40Ω, 60Ω, or 120Ω	High	On		DQS receiving: terminated by R <sub>TT</sub> Prime DQ driving CK state: not terminated Other DQ driving LOW: not terminated	4	

- Notes:
- 1 Expected usage if used during write leveling: Case 1 may be used when DRAM are on a dual-rank module and on the rank not being leveled or on any rank of a module not being leveled on a multi slot system. Case 2 may be used when DRAM are on any rank of a module not being leveled on a multi slot system. Case 3 is generally not used. Case 4 is generally used when DRAM are on the rank that is being leveled.
  - 2 Since the DRAM DQS is not being driven (MR1[12] = 1), DQS ignores the input strobe, and all R<sub>TT,nom</sub> values are allowed. This simulates a normal standby state to DQS.
  - 3 Since the DRAM DQS is being driven (MR1[12] = 0), DQS captures the input strobe, and only some R<sub>TT,nom</sub> values are allowed. This simulates a normal write state to DQS.



## 14.1 Write Leveling Procedure

A memory controller initiates the DRAM write leveling mode by setting MR1[7] to 1, as- summing the other programable features (MR0, MR1, MR2, and MR3) are first set and the DLL is fully reset and locked. The DQ balls enter the write leveling mode going from a High-Z state to an undefined driving state, so the DQ bus should not be driven. During write leveling mode, only the NOP or DES commands are allowed. The memory controller should attempt to level only one rank at a time; thus, the outputs of other ranks should be disabled by setting MR1[12] to 1 in the other ranks. The memory controller may assert ODT after a tMOD delay, as the DRAM will be ready to process the ODT transition. ODT should be turned on prior to DQS being driven LOW by at least ODTL on delay (WL-2tCK), provided it does not violate the aforementioned tMOD delay requirement.

The memory controller may drive DQSLOW and DQS# HIGH after tWLDQSEN has been satisfied. The controller may begin to toggle DQS after tWLMRD (oneDQS toggle is DQS transitioning from a LOW state to a HIGH state with DQS# transitioning from a HIGH state to a LOW state, then both transition back to their original states). At a minimum, ODTL<sub>on</sub> and tAON must be satisfied at least one clock prior to DQS toggling. After tWLMRD and a DQS LOW preamble (tWPRE) have been satisfied, the memory controller may provide either a single DQS toggle or multiple DQS toggles to sample CK for a given DQS-to-CK skew. Each DQS toggle must not violate tDQSL (MIN) and tDQSH (MIN) specifications. tDQSL (MAX) and tDQSH(MAX) specifications are not applicable during write leveling mode. The DQS must be able to distinguish the CK's rising edge within tWLS and tWLH. The prime DQ will output the CK's status asynchronously from the associated DQS rising edge CK capture within tWLO. The remaining DQ that always drive LOW when DQS is toggling must be LOW within tWLOE after the first tWLO is satisfied (the prime DQ going LOW). As previously noted, DQS is an input and not an output during this process.

The memory controller will most likely sample each applicable prime DQ state and determine whether to increment or decrement its DQS delay setting. After the memory controller performs enough DQS toggles to detect the CK's 0-to-1 transition, the memory controller should lock the DQS delay setting for that DRAM. After locking the DQS setting is locked, leveling for the rank will have been achieved, and the write leveling mode for the rank should be disabled or reprogrammed (if write leveling of another rank follows).



## 14.2 Write Leveling Sequence

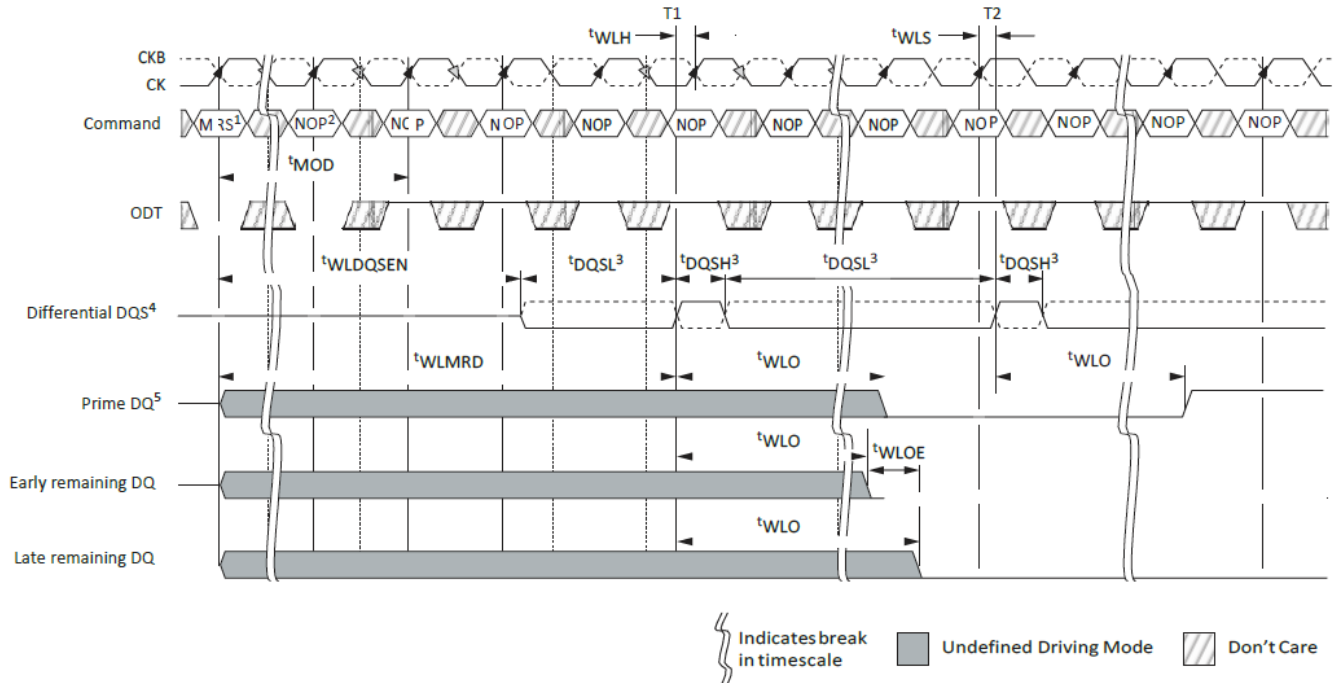

- Notes:
- 1 MRS: Load MR1 to enter write leveling mode.
  - 2 NOP: NOP or DES.
  - 3 DQS, DQS# needs to fulfill minimum pulse width requirements  $t_{DQSH}$  (MIN) and  $t_{DQSL}$  (MIN) as defined for regular writes. The maximum pulse width is system-dependent.
  - 4 Differential DQS is the differential data strobe (DQS, DQS#). Timing reference points are the zero crossings. The solid line represents DQS; the dotted line represents DQS#.
  - 5 DRAM drives leveling feedback on a prime DQ (DQ0 for x4 and x8). The remaining DQ are driven LOW and remain in this state throughout the leveling procedure.



### 14.3 Write Leveling Mode Exit Procedure

After the DRAM are leveled, they must exit from write leveling mode before the normal mode can be used. Depicts a general procedure for exiting write leveling mode. After the last rising DQS (capturing 1 at T0), the memory controller should stop driving the DQS signals after tWLO(MAX) delay plus enough delay to enable the memory controller to capture the applicable prime DQ state (at ~Tb0). The DQ balls become undefined when DQS no longer remains LOW, and they remain undefined until tMOD after the MRS command (at Te1).

The ODT input should be de-asserted LOW such that ODTL off (MIN) expires after the DQS is no longer driving LOW. When ODT LOW satisfies tIS, ODT must be kept LOW (at ~Tb0) until the DRAM is ready for either another rank to be leveled or until the normal mode can be used. After DQS termination is switched off, write level mode should be disabled via the MRS command (at Tc2). After tMOD is satisfied (at Te1), any valid command may be registered by the DRAM. Some MRS commands may be issued after tMRD (at Td1).

#### Write Leveling Exit Procedure

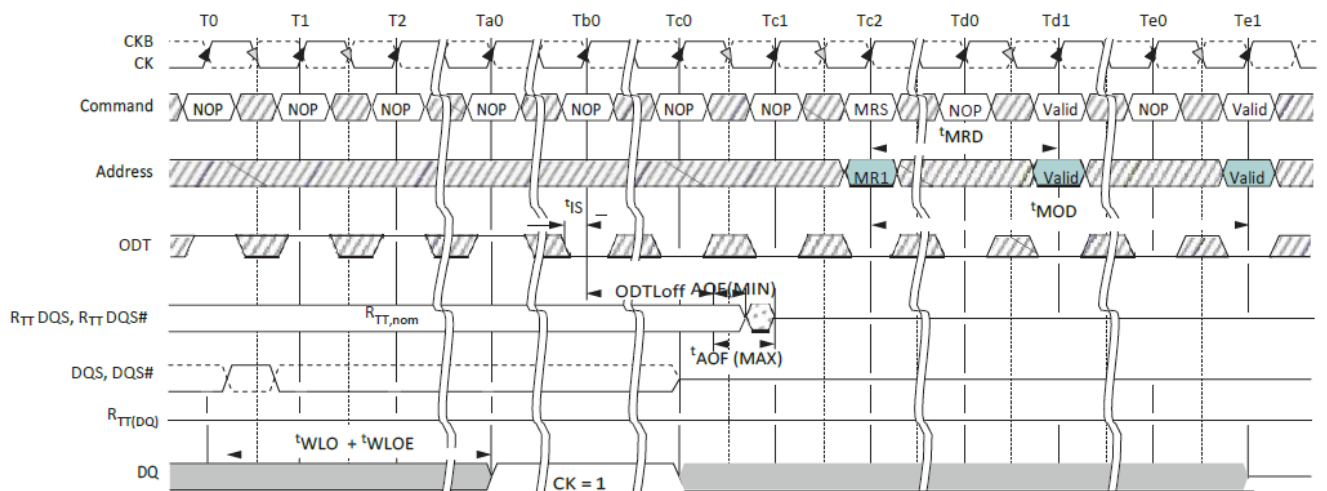

Indicates break in time scale  
 Undefined Driving Mode  
 Transitioning  
 Don't Care

Note: 1. The DQ result, = 1, between Ta0 and Tc0, is a result of the DQS, DQS# signals capturing CK HIGH just after the T0 state.





## 15. Initialization

### 15.1 Power-Up Initialization

following sequence is required for power-up and initialization, as shown;

1. Apply power. RESET# is recommended to be below  $0.2 \times VDDQ$  during power ramp to ensure the outputs remain disabled (High-Z) and ODT off (RTT is also High-Z). All other inputs, including ODT, may be undefined. During power-up, either of the following conditions may exist and must be met:

- Condition A:

- VDD and VDDQ are driven from a single-power converter output and are ramped with a maximum delta voltage between them of  $\Delta V \leq 300\text{mV}$ . Slope reversal of any power supply signal is allowed. The voltage level on all balls other than VDD, VDDQ, VSS, VSSQ must be less than or equal to VDDQ and VDD on one side, and must be greater than or equal to VSSQ and VSS on the other side.

- Both VDD and VDDQ power supplies ramp to VDD,min and VDDQ,min within  $t_{VDDPR} = 200\text{ms}$ .

- VREFDQ tracks  $VDD \times 0.5$ , VREFCA tracks  $VDD \times 0.5$ .

- VTT is limited to 0.95V when the power ramp is complete and is not applied directly to the device; however,  $t_{VTD}$  should be greater than or equal to 0 to avoid device latch up.

- Condition B:

- VDD may be applied before or at the same time as VDDQ.

- VDDQ may be applied before or at the same time as VTT, VREFDQ, and VREFCA.

- No slope reversals are allowed in the power supply ramp for this condition.

2. Until stable power, maintain RESET# LOW to ensure the outputs remain disabled (High-Z). After the power is stable, RESET# must be LOW for at least 200 $\mu\text{s}$  to begin the initialization process. ODT will remain in the High-Z state while RESET# is LOW and until CKE is registered HIGH.

3. CKE must be LOW 10ns prior to RESET# transitioning HIGH.

4. After RESET# transitions HIGH, wait 500 $\mu\text{s}$  (minus one clock) with CKE LOW.

5. After the CKE LOW time, CKE may be brought HIGH (synchronously) and only NOP or DES commands may be issued. The clock must be present and valid for at least 10ns (and a minimum of five clocks) and ODT must be driven LOW at least  $t_{IS}$  prior to CKE being registered HIGH. When CKE is registered HIGH, it must be continuously registered HIGH until the full initialization process is complete.

6. After CKE is registered HIGH and after  $t_{XPR}$  has been satisfied, MRS commands may be issued. Issue an MRS (LOAD MODE) command to MR2 with the applicable settings (provide LOW to BA2 and BA0 and HIGH to BA1).

7. Issue an MRS command to MR3 with the applicable settings.

8. Issue an MRS command to MR1 with the applicable settings, including enabling the DLL and configuring ODT.



9. Issue an MRS command to MR0 with the applicable settings, including a DLL RESET command.  $t_{DLLK}$  (512) cycles of clock input are required to lock the DLL.
10. Issue a ZQCL command to calibrate RTT and RON values for the process voltage temperature (PVT). Prior to normal operation,  $t_{ZQinit}$  must be satisfied.
11. When  $t_{DLLK}$  and  $t_{ZQinit}$  have been satisfied, the DDR3 SDRAM will be ready for normal operation.

**Initialization Sequence**

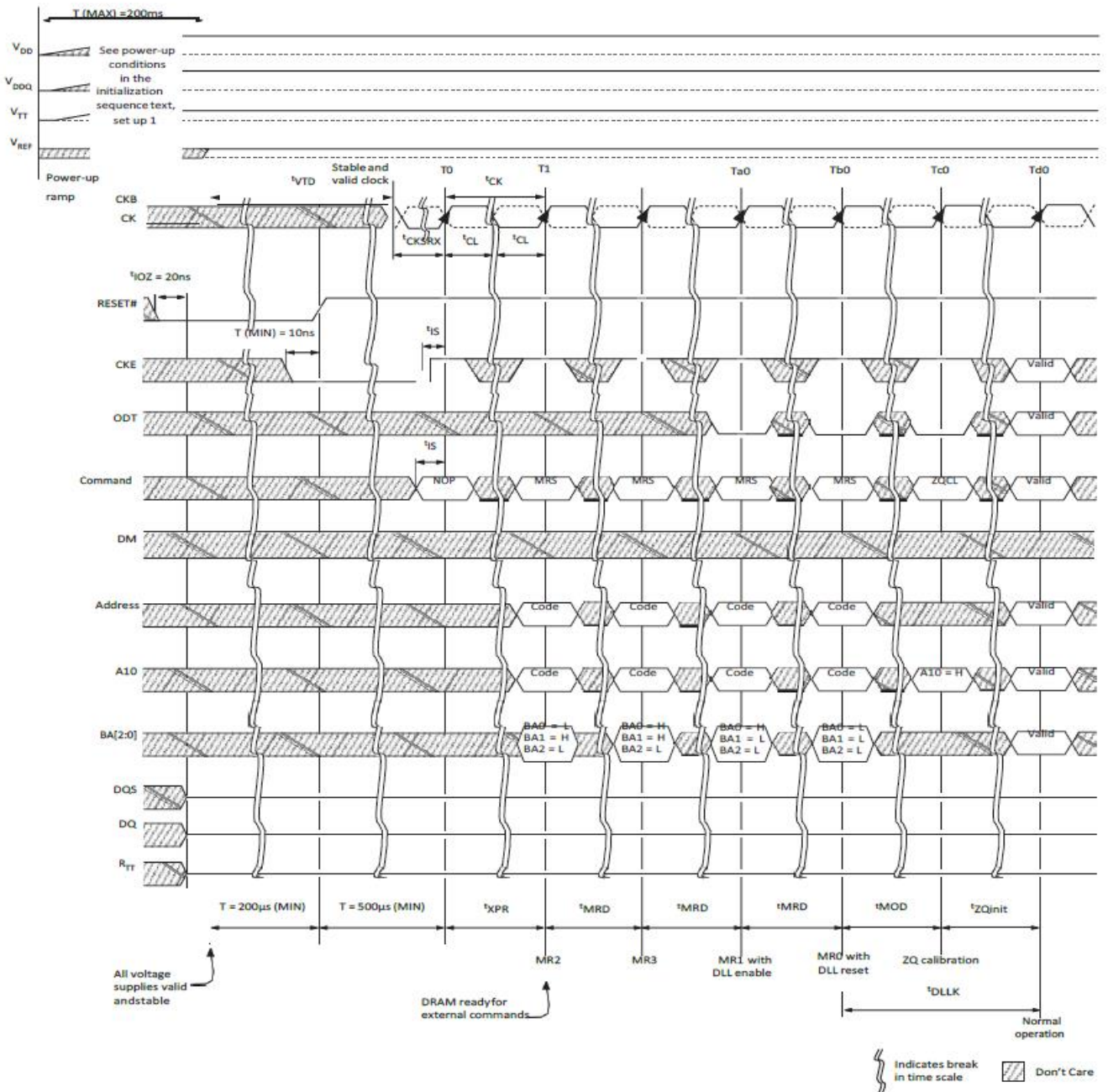

## 15.2 Voltage Initialization / Change

If the SDRAM is powered up and initialized for the 1.35V operating voltage range, voltage can be increased to the 1.5V operating range provided the following conditions are met:

- Just prior to increasing the 1.35V operating voltages, no further commands are issued, other than NOPs or COMMAND INHIBITs, and all banks are in the precharge state.
- The 1.5V operating voltages are stable prior to issuing new commands, other than NOP sor COMMAND INHIBITs.
- The DLL is reset and relocked after the 1.5V operating voltages are stable and prior to any READ command.
- The ZQ calibration is performed. tZQinit must be satisfied after the 1.5V operating voltages are stable and prior to any READ command.

If the SDRAM is powered up and initialized for the 1.5V operating voltage range, voltage Can be reduced to the 1.35Voperationrangeprovidedthe following conditions are met:

- Just prior to reducing the 1.5V operating voltages, no further commands are issued, other than NOPs or COMMAND INHIBITs, and all banks are in the precharge state.
- The 1.35V operating voltages are stable prior to issuing new commands, other than NOP sor COMMAND INHIBITs.
- The DLL is reset and relocked after the 1.35V operating voltages are stable and prior to any READ command.
- The ZQ calibration is performed. tZQinit must be satisfied after the 1.35V operating voltages are stable and prior to any READ command.



### 15.3 VDD Voltage Switching

After the DDR3L DRAM is powered up and initialized, the power supply can be altered between the DR3L and DDR3 levels, provided the sequence in is maintained.

VDD Voltage Switching

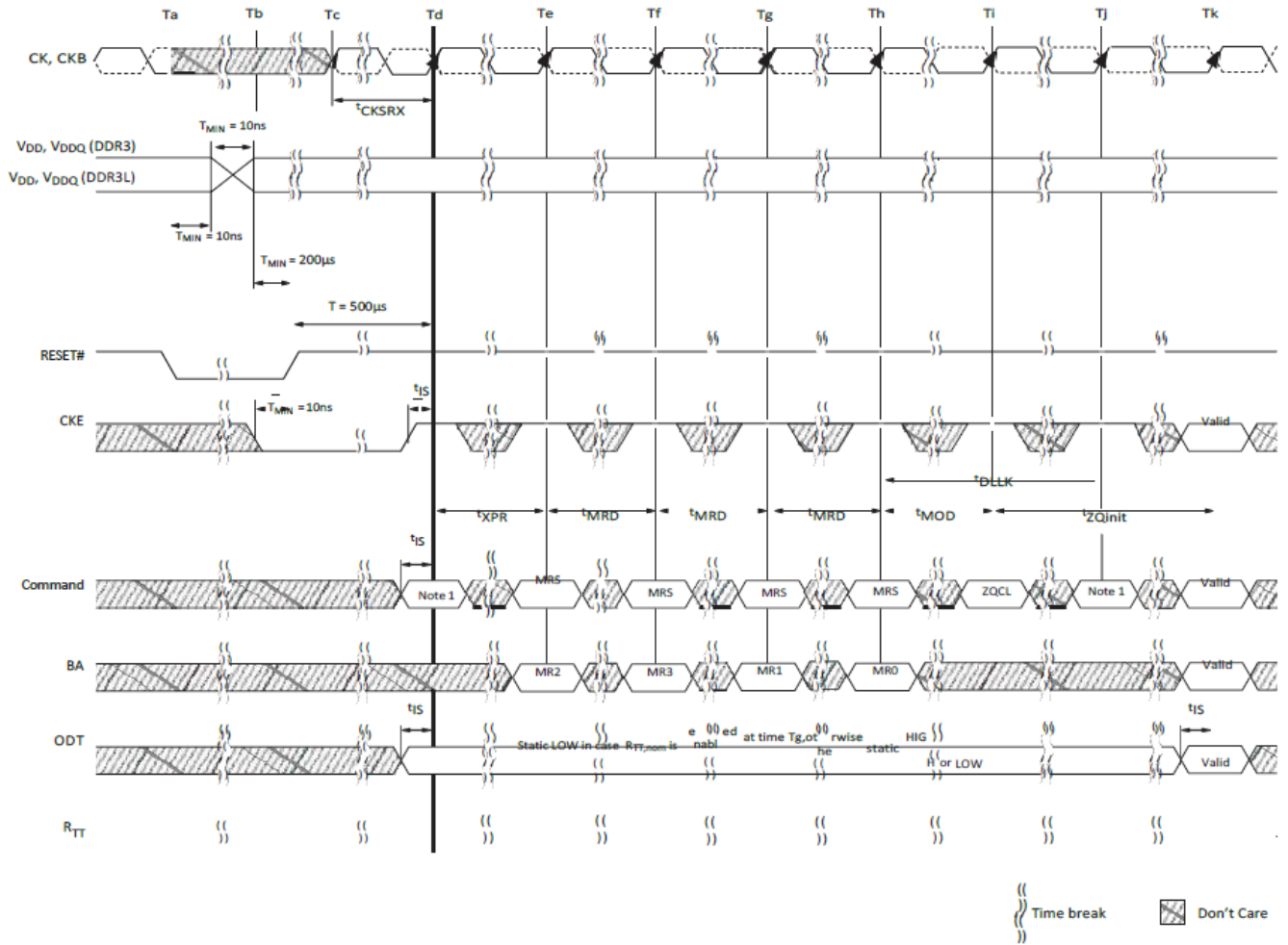

Note: 1. From time point Td until Tk, NOP or DES commands must be applied between MRS and ZQCL commands.



## 15.4 Mode Registers

Mode registers (MR0–MR3) are used to define various modes of programmable operations of the DDR3 SDRAM. A mode register is programmed via the mode register set (MRS) command during initialization, and it retains the stored information (except for MR0[8], which is self-clearing) until it is reprogrammed, RESET# goes LOW, the device loses power.

Contents of a mode register can be altered by re-executing the MRS command. Even if the user wants to modify only a subset of the mode register’s variables, all variables must be programmed when the MRS command is issued. Reprogramming the mode register will not alter the contents of the memory array, provided it is performed correctly. The MRS command can only be issued (or re-issued) when all banks are idle and in the precharged state ( $t_{RP}$  is satisfied and no data bursts are in progress). After an MRS command has been issued, two parameters must be satisfied:  $t_{MRD}$  and  $t_{MOD}$ . The controller must wait  $t_{MRD}$  before initiating any subsequent MRS commands.

### MRS to MRS Command Timing ( $t_{MRD}$ )

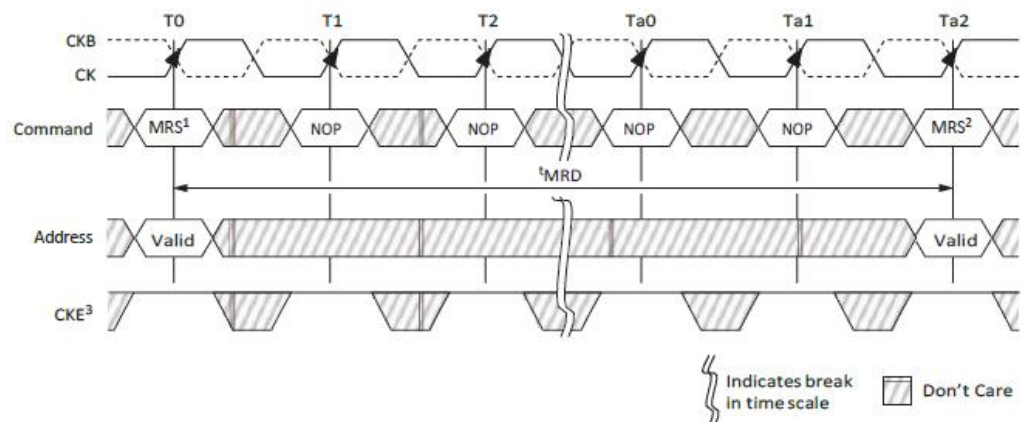

- Notes:
- 1 Prior to issuing the MRS command, all banks must be idle and precharged,  $t_{RP}$  (MIN) must be satisfied, and no data bursts can be in progress
  - 2  $t_{MRD}$  specifies the MRS to MRS command minimum cycle time.
  - 3 CKE must be registered HIGH from the MRS command until  $t_{MRSPDEN}$  (MIN) (see Power-Down Mode).
  - 4 For a CAS latency change,  $t_{XPDLL}$  timing must be met before any non-MRS command.

The controller must also wait  $t_{MOD}$  before initiating any non-MRS commands (excluding NOP and DES). The DRAM requires  $t_{MOD}$  in order to update the requested features, with the exception of DLL RESET, which requires additional time. Until  $t_{MOD}$  has been satisfied, the updated features are to be assumed unavailable.



### MRS to nonMRS Command Timing ( $t_{MOD}$ )

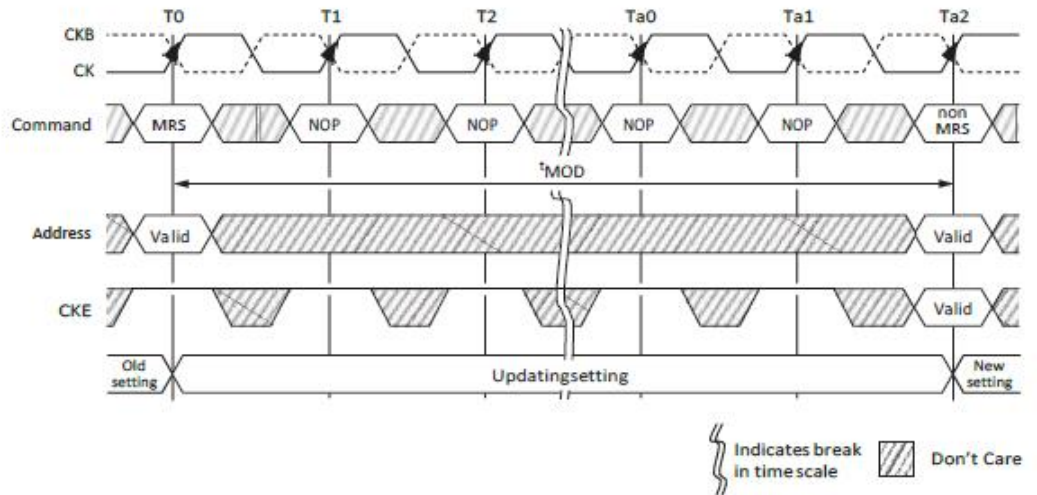

- Notes:
1. Prior to issuing the MRS command, all banks must be idle (they must be precharged, tRP must be satisfied, and no data bursts can be in progress).
  2. Prior to Ta2 when tMOD (MIN) is being satisfied, no commands (except NOP/DES) may be issued.
  3. If RTT was previously enabled, ODT must be registered LOW at T0 so that ODTL is satisfied prior to Ta1. ODT must also be registered LOW at each rising CK edge from T0 until tMODmin is satisfied at Ta2.
  4. CKE must be registered HIGH from the MRS command until tMRSPDEN (MIN), at which time power-down may occur (see Power-Down Mode).

### Mode Register 0 (MR0)

The base register, mode register 0 (MR0), is used to define various DDR3 SDRAM modes of operation. These definitions include the selection of a burst length, burst type, CAS latency, operating mode, DLL RESET, write recovery, and precharge power-down mode.

#### Burst Length

Burst length is defined by MR0[1:0]. Read and write accesses to the DDR3 SDRAM are burst-oriented, with the burst length being programmable to 4 (chop) mode, 8 (fixed) mode, or selectable using A12 during a READ/WRITE command (on-the-fly). The burst length determines the maximum number of column locations that can be accessed for a given READ or WRITE command. When MR0 [1:0] is set to 01 during a READ/WRITE command, if A12=0, then BC4mode is selected. If A12=1, then BL8 mode is selected. Specific timing diagrams, and turn around between READ/WRITE, are shown in the READ/WRITE sections of this document.

When a READ or WRITE command is issued, a block of columns equal to the burst length is effectively selected. All accesses for that burst take place within this block, meaning that the burst will wrap within the block if a boundary is reached. The



block is uniquely selected by  $A[i:2]$  when the burst length is set to 4 and by  $A[i:3]$  when the burst length is set to 8, where  $A_i$  is the most significant column address bit for a given configuration. The remaining (least significant) address bit(s) is (are) used to select the starting location within the block. The programmed burst length applies to both READ and WRITE bursts

**Mode Register 0 (MR0) Definitions**

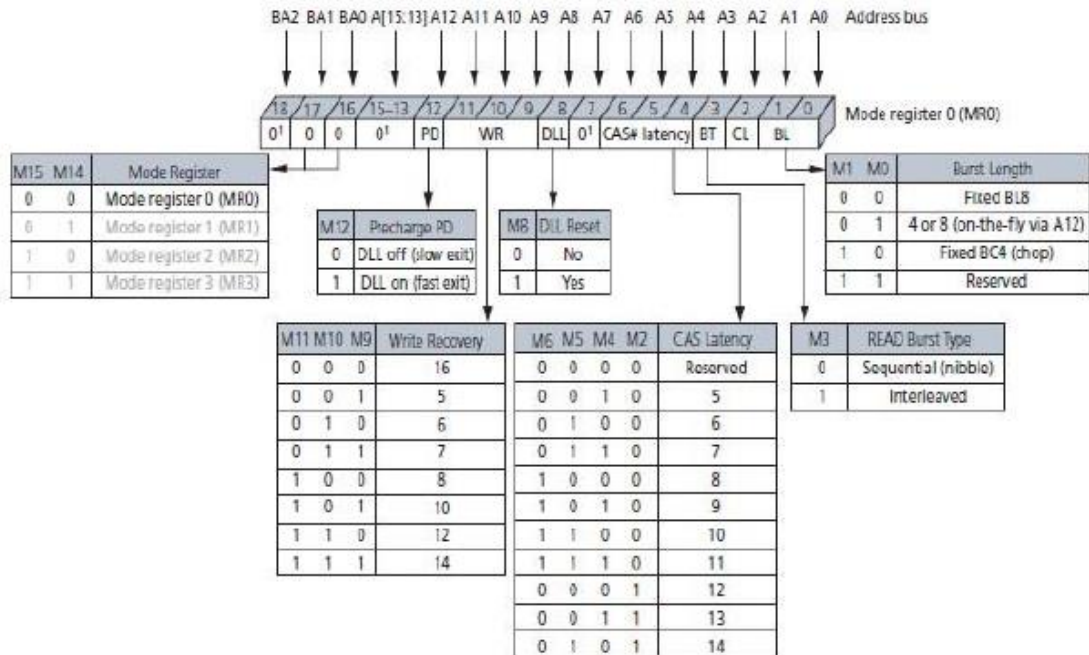

Note: 1. MR0[18, 15:13, 7] are reserved for future use and must be programmed to 0.

**Burst Type**

Accesses within a given burst can be programmed to either a sequential or an interleaved order. The burst type is selected via MR0[3]. The ordering of accesses within a burst is determined by the burst length, the burst type, and the starting column address. DDR3 only supports 4-bit burst chop and 8-bit burst access modes. Full interleave address ordering is supported for READs, while WRITEs are restricted to nibble (BC4) or word (BL8) boundaries.



### Burst Order

Burst Length	READ/ WRITE	Starting Column Address (A[2, 1, 0])	Burst Type = Sequential (Decimal)	Burst Type = Interleaved (Decimal)	Notes
4 (chop)	READ	000	0, 1, 2, 3, Z, Z, Z, Z	0, 1, 2, 3, Z, Z, Z, Z	1, 2
		001	1, 2, 3, 0, Z, Z, Z, Z	1, 0, 3, 2, Z, Z, Z, Z	1, 2
		010	2, 3, 0, 1, Z, Z, Z, Z	2, 3, 0, 1, Z, Z, Z, Z	1, 2
		011	3, 0, 1, 2, Z, Z, Z, Z	3, 2, 1, 0, Z, Z, Z, Z	1, 2
		100	4, 5, 6, 7, Z, Z, Z, Z	4, 5, 6, 7, Z, Z, Z, Z	1, 2
		101	5, 6, 7, 4, Z, Z, Z, Z	5, 4, 7, 6, Z, Z, Z, Z	1, 2
		110	6, 7, 4, 5, Z, Z, Z, Z	6, 7, 4, 5, Z, Z, Z, Z	1, 2
		111	7, 4, 5, 6, Z, Z, Z, Z	7, 6, 5, 4, Z, Z, Z, Z	1, 2
	WRITE	0VV	0, 1, 2, 3, X, X, X, X	0, 1, 2, 3, X, X, X, X	1, 3, 4
1VV		4, 5, 6, 7, X, X, X, X	4, 5, 6, 7, X, X, X, X	1, 3, 4	
8 (fixed)	READ	000	0, 1, 2, 3, 4, 5, 6, 7	0, 1, 2, 3, 4, 5, 6, 7	1
		001	1, 2, 3, 0, 5, 6, 7, 4	1, 0, 3, 2, 5, 4, 7, 6	1
		010	2, 3, 0, 1, 6, 7, 4, 5	2, 3, 0, 1, 6, 7, 4, 5	1
		011	3, 0, 1, 2, 7, 4, 5, 6	3, 2, 1, 0, 7, 6, 5, 4	1
		100	4, 5, 6, 7, 0, 1, 2, 3	4, 5, 6, 7, 0, 1, 2, 3	1
		101	5, 6, 7, 4, 1, 2, 3, 0	5, 4, 7, 6, 1, 0, 3, 2	1
		110	6, 7, 4, 5, 2, 3, 0, 1	6, 7, 4, 5, 2, 3, 0, 1	1
		111	7, 4, 5, 6, 3, 0, 1, 2	7, 6, 5, 4, 3, 2, 1, 0	1
	WRITE	VVV	0, 1, 2, 3, 4, 5, 6, 7	0, 1, 2, 3, 4, 5, 6, 7	1, 3

- Notes: 1. Internal READ and WRITE operations start at the same point in time for BC4 as they do for BL8.  
 2. Z = Data and strobe output drivers are in tri-state.  
 3. V = A valid logic level (0 or 1), but the respective input buffer ignores level-on input pins.  
 4. X = "Don't Care."

### DLL RESET

DLLRESET is defined by MR0[8]. Programming MR0[8] to 1 activates the DLL RESET function. MR0 [8] is self-clearing, meaning it returns to a value of 0 after the DLL RESET function has been initiated. Anytime the DLL RESET function is initiated, CKE must be HIGH and the clock held stable for 512(tDLLK) clock cycles before a READ command can be issued. This is to allow time for the internal clock to be synchronized with the external clock. Failing to wait for synchronization can result in invalid output timing specifications, such as tDQSCK timings.

### Write Recovery

WRITE recovery time is defined by MR0[11:9]. Write recovery values of 5, 6, 7, 8, 10,





or 12 can be used by programming MR0[11:9]. The user is required to program the correct value of write recovery, which is calculated by dividing  $tWR(ns)$  by  $tCK(ns)$  and rounding up a non-integer value to the next integer:

$WR(\text{cycles}) = \text{roundup}(tWR(\text{ns})/tCK(\text{ns}))$ .

#### **Precharge Power-Down (Precharge PD)**

The precharge power-down(precharge PD) bit applies only when precharge power down mode is being used. When MR0[12] is set to 0, the DLL is off during precharge power-down, providing a lower standby current mode; however,  $tXPDLL$  must be satisfied when exiting. When MR0[12] is set to 1, the DLL continues to run during precharge power-down mode to enable a faster exit of precharge power-down mode; however,  $tXP$  must be satisfied when exiting (see Power-Down Mode).

#### **CAS Latency (CL)**

CAS latency(CL) is defined by MR0[6:4], as shown. CAS latency is the delay, in clock cycles, between the internal READ command and the availability of the first bit of output data. CL can be set to 5 through 14. DDR3 SDRAM do not support half-clock latencies.

Examples of CL=6 and CL=8 are shown below. If an internal READ command is registered at clock edge  $n$ , and the CAS latency is  $m$  clocks, the data will be available nominally coincident with clock edge  $n + m$ . See Speed Bin Tables for the CLs supported at various operating frequencies



**READ Latency**

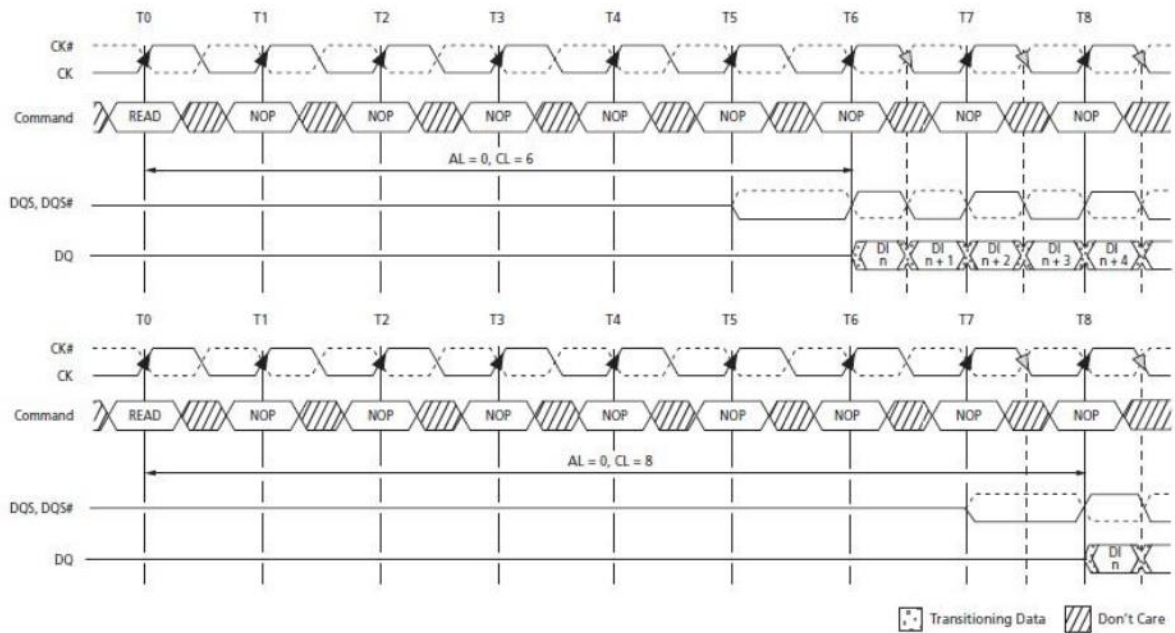

- Notes: 1. For illustration purposes, only CL = 6 and CL = 8 are shown. Other CL values are possible.  
2. Shown with nominal <sup>t</sup>DQSCK and nominal <sup>t</sup>DSDQ.

**Mode Register 1 (MR1)**

The mode register 1 (MR1) controls additional functions and features not available in the other mode registers: Q OFF (OUTPUT DISABLE), , DLL ENABLE/DLL



DISABLE,  $R_{TT,nom}$  value (ODT), WRITE LEVELING, POSTED CAS ADDITIVE latency, and OUTPUT DRIVE STRENGTH. These functions are controlled via the bits shown. The MR1 register is programmed via the MRS command and retains the stored information until it is reprogrammed, until RE-SET# goes LOW, or until the device loses power. Reprogramming the MR1 register will not alter the contents of the memory array, provided it is performed correctly. The MR1 register must be loaded when all banks are idle and no bursts are in progress. The controller must satisfy the specified timing parameters  $t_{MRD}$  and  $t_{MOD}$  before initiating a subsequent operation.

**Mode Register 1 (MR1) Definition**

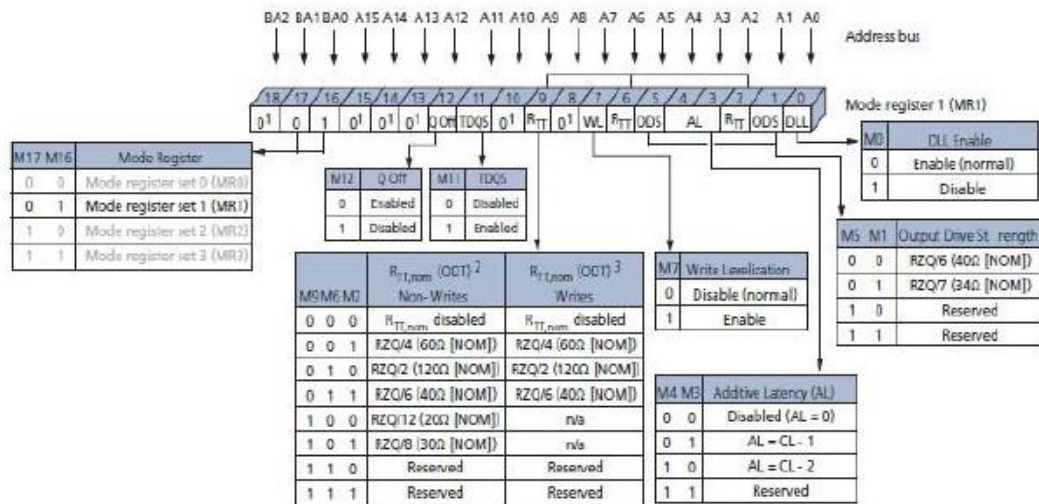

- Notes:
- MR1[18, 15:13, 10, 8] are reserved for future use and must be programmed to 0.
  - During write leveling, if MR1[7] and MR1[12] are 1, then all  $R_{TT,nom}$  values are available for use.
  - During write leveling, if MR1[7] is a 1, but MR1[12] is a 0, then only  $R_{TT,nom}$  write values are available for use.

**DLL Enable/DLL Disable**

The DLL may be enabled or disabled by programming MR1[0] during the LOADMODE command, as shown. The DLL must be enabled for normal operation. DLL enable is required during power-up initialization and upon returning to normal operation after having disabled the DLL for the purpose of debugging or evaluation. Enabling the DLL should always be followed by resetting the DLL using the appropriate LOAD MODE command. If the DLL is enabled prior to entering self refresh mode, the DLL is automatically disabled when entering SELF REFRESH operation and is automatically re-enabled and reset upon exit of SELF REFRESH operation. If the DLL is disabled prior to entering self refresh mode, the DLL remains disabled even upon exit of SELF REFRESH operation until it is re-enabled and reset. The DRAM is not tested to check—nor does PTC warrant compliance with—normal mode timings or functionality when the DLL is disabled. An attempt has been made



to have the DRAM operate in the normal mode where reasonably possible when the DLL has been disabled; however, by industry standard, a few known exceptions are defined:

- ODT is not allowed to be used
- The output data is no longer edge-aligned to the clock
- CL and CWL can only be six clocks

When the DLL is disabled, timing and functionality can vary from the normal operation specifications when the DLL is enabled (see DLL Disable Mode. Disabling the DLL also implies the need to change the clock frequency (see Input Clock Frequency Change).

### Output Drive Strength

The DDR3 SDRAM uses a programmable impedance output buffer. The drive strength mode register setting is defined by MR1[5, 1]. RZQ/7 ( $34\Omega$  [NOM]) is the primary output driver impedance setting for DDR3 SDRAM devices. To calibrate the output driver impedance, an external precision resistor (RZQ) is connected between the ZQ ball and VSSQ.

The value of the resistor must be  $240\Omega \pm 1\%$ . The output impedance is set during initialization. Additional impedance calibration updates do not affect device operation, and all data sheet timings and current specifications are met during an update.

To meet the  $34\Omega$  specification, the output drive strength must be set to  $34\Omega$  during initialization. To obtain a calibrated output driver impedance after power-up, the DDR3 SDRAM needs a calibration command that is part of the initialization and reset procedure.

### OUTPUT ENABLE/DISABLE

The OUTPUT ENABLE function is defined by MR1[12], as shown. When enabled (MR1[12] = 0), all outputs (DQ, DQS, DQS#) function when in the normal mode of operation. When disabled (MR1[12] = 1), all DDR3 SDRAM outputs (DQ and DQS, DQS#) are tri-stated. The output disable feature is intended to be used during IDD characterization of the READ current and during tDQSS margining (write leveling) only.

### On-Die Termination



ODT resistance  $RTT_{nom}$  is defined by MR1[9,6,2]. The  $RTT$  termination value applies to the DQ, DM, DQS, DQS# balls. DDR3 supports multiple  $RTT$  termination values based on  $RZQ/n$  where  $n$  can be 2, 4, 6, 8, or 12 and  $RZQ$  is  $240\Omega$ . Unlike DDR2, DDR3 ODT must be turned off prior to reading data out and must remain off during a READ burst.  $RTT_{nom}$  termination is allowed any time after the DRAM is initialized, calibrated, and not performing read access, or when it is not in self refresh mode. Additionally, write accesses with dynamic ODT ( $RTT(WR)$ ) enabled temporarily re-replaces  $RTT_{nom}$  with  $RTT(WR)$ . The actual effective termination,  $RTT(EFF)$ , may be different from the  $RTT$  targeted due to nonlinearity of the termination. For  $RTT(EFF)$  values and calculations (see On-Die Termination(ODT)). The ODT feature is designed to improve signal integrity of the memory channel by enabling the DDR3 SDRAM controller to independently turn on/off ODT for any or all devices. The ODT input control pin is used to determine when  $RTT$  is turned on( $ODTLon$ ) and off( $ODTLoff$ ), assuming ODT has been enabled via MR1[9,6,2]. Timings for ODT are detailed in On-Die Termination (ODT).

#### WRITE LEVELING

The WRITE LEVELING function is enabled by MR1[7], as shown. Write leveling is used (during initialization) to deskew the DQS strobe to clock offset as a result of fly-by topology designs. For better signal integrity, DDR3 SDRAM memory modules adopted fly-by topology for the commands, addresses, control signals, and clocks. The fly-by topology benefits from a reduced number of stubs and their lengths. However, fly-by topology induces flight time skews between the clock and DQS strobe (and DQ) at each DRAM on the DIMM. Controllers will have a difficult time maintaining  $tDQSS$ ,  $tDSS$ , and  $tDSH$  specifications without supporting write leveling in systems which use fly-by topology-based modules. Write leveling timing and detailed operation information is provided in Write Leveling.

#### POSTED CAS ADDITIVE Latency

POSTED CAS ADDITIVE latency( $AL$ ) is supported to make the command and data bus efficient for sustainable bandwidths in DDR3 SDRAM. MR1[4, 3] define the value of  $AL$ , as shown. MR1[4, 3] enable the user to program the DDR3 SDRAM with  $AL = 0$ ,  $CL - 1$ , or  $CL - 2$ .

With this feature, the DDR3 SDRAM enables a READ or WRITE command to be issued after the ACTIVATE command for that bank prior to  $Trcd$  (MIN). The only restriction is ACTIVATE to READ or WRITE+  $AL \geq tRCD(MIN)$  must be satisfied. Assuming  $tRCD(MIN) = CL$ , a typical application using this feature sets  $AL = CL - 1tCK = tRCD(MIN) - 1tCK$ . The READ or WRITE command is held for the time of the  $AL$  before it is released internally to the DDR3 SDRAM device. READ latency ( $RL$ ) is controlled by the sum of the  $AL$  and CAS latency ( $CL$ ),  $RL = AL + CL$ . WRITE latency( $WL$ ) is the sum of CAS WRITE latency and  $AL$ ,  $WL = AL + CWL$  (see Mode Register 2 (MR2)). Examples of READ and WRITE latencies are shown.



**READ Latency (AL = 5, CL = 6)**

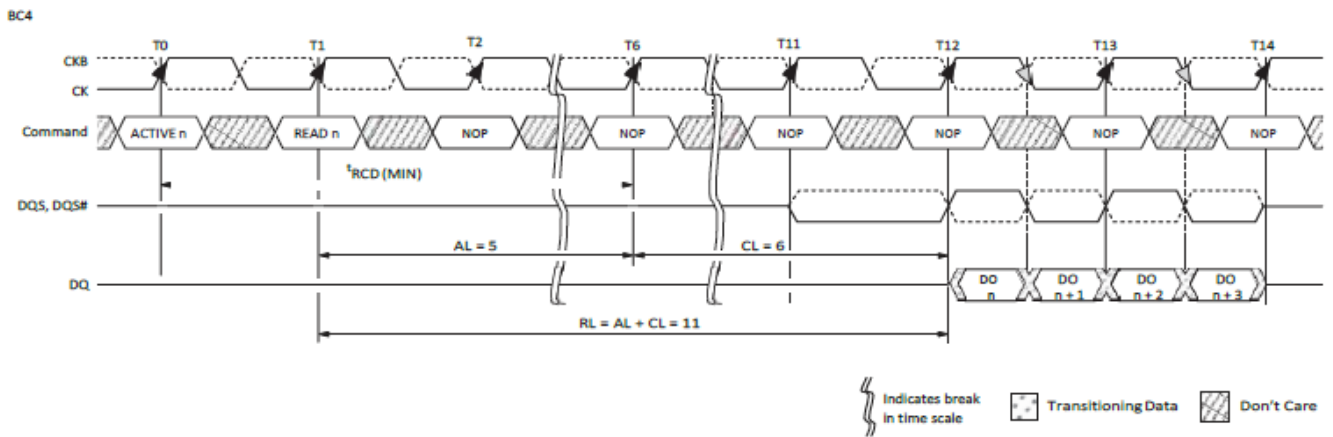

**Mode Register 2 (MR2)**

The mode register 2 (MR2) controls additional functions and features not available in the other mode registers. These additional functions are CAS WRITE latency (CWL), AUTO SELF REFRESH(ASR), SELF REFRESH TEMPERATURE (SRT), and DYNAMIC ODT (RTT(WR)). These functions are controlled via the bits shown. The MR2 is programmed via the MRS command and will retain the stored information until it is programmed again or until the device loses power. Reprogramming the MR2 register will not alter the contents of the memory array, provided it is performed correctly. The MR2 register must be loaded when all banks are idle and no data bursts are in progress, and the controller must wait the specified time tMRD and tMOD before initiating a sub-Subsequent operation.

**Mode Register 2 (MR2) Definition**



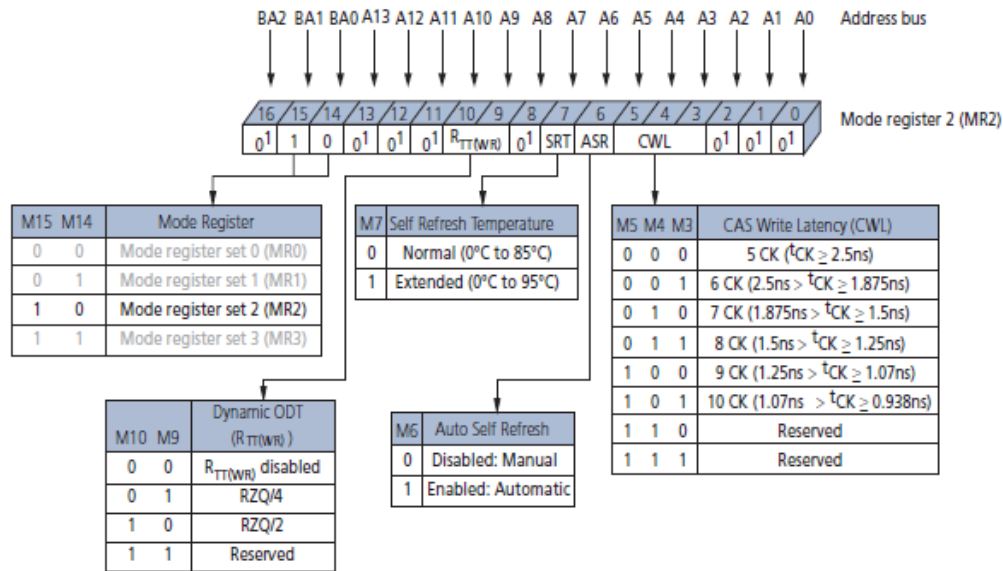

Note: 1. MR2[18, 15:11, 8, and 2:0] are reserved for future use and must all be programmed to 0.

### CAS WRITE Latency(CWL)

CWL is defined by MR2[5:3] and is the delay, in clock cycles, from the releasing of the internal write to the latching of the first data in. CWL must be correctly set to the corresponding operating clock frequency. The overall WRITE latency(WL) is equal to CWL+AL.

### CAS WRITE Latency

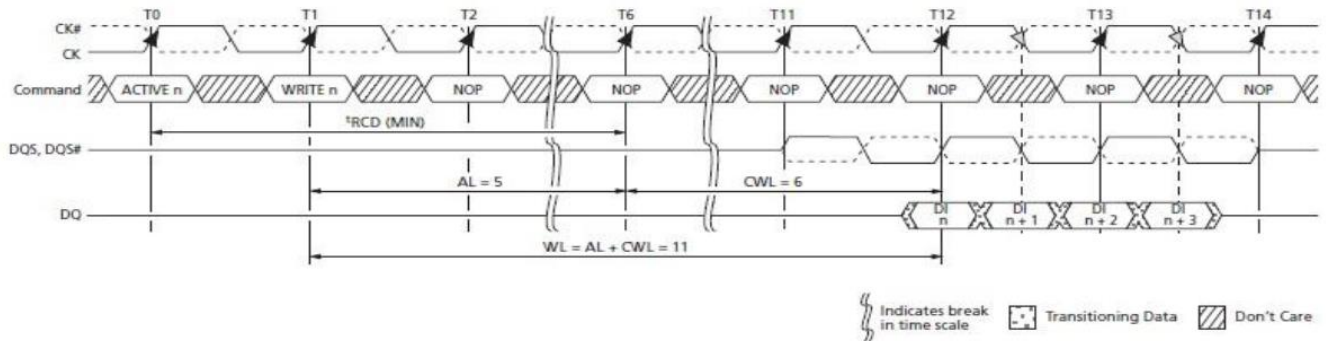

### AUTO SELF REFRESH (ASR)

Mode register MR2[6] is used to disable/enable the ASR function. When ASR is disabled, the self refresh mode's refresh rate is assumed to be at the normal 85°C limit (sometimes referred to as 1x refresh rate). In the disabled mode, ASR requires the user to ensure the DRAM never exceeds a Tc of 85°C while in self refresh unless the user enables the SRT feature listed below when the Tc is between 85°C and 95°C. Enabling ASR assumes the DRAM self refresh rate is changed automatically from 1x to 2x when the case temperature exceeds 85°C. This enables the user to operate the DRAM beyond the standard 85°C limit up to the optional extended temperature range of 95°C while in self refresh mode. The standard self refresh current test specifies test



conditions to normal case temperature (85°C) only, meaning if ASR is enabled, the standard self refresh current specifications do not apply (see Extended Temperature Usage).

### SELF REFRESH TEMPERATURE (SRT)

Mode register MR2[7] is used to disable/enable the SRT function. When SRT is disabled, the self refresh mode's refresh rate is assumed to be at the normal 85°C limit (sometimes referred to as 1x refresh rate). In the disabled mode, SRT requires the user to ensure the DRAM never exceeds a TC of 85°C while in self refresh mode unless the user enables ASR.

When SRT is enabled, the DRAM self refresh is changed internally from 1x to 2x, regardless of the case temperature. This enables the user to operate the DRAM beyond the standard 85°C limit up to the optional extended temperature range of 95°C while in self refresh mode. The standard self refresh current test specifies test conditions to normal case temperature (85°C) only, meaning if SRT is enabled, the standard self refresh current specifications do not apply (see Extended Temperature Usage).

### SRT vs. ASR

If the normal case temperature limit of 85°C is not exceeded, then neither SRT nor ASR is required, and both can be disabled throughout operation. However, if the extended temperature option of 95°C is needed, the user is required to provide a 2x refresh rate during (manual) refresh and to enable either the SRT or the ASR to ensure self refresh is performed at the 2x rate. SRT forces the DRAM to switch the internal self refresh rate from 1x to 2x. Self refresh is performed at the 2x refresh rate regardless of the case temperature. ASR automatically switches the DRAM's internal self refresh rate from 1x to 2x. However, while in self refresh mode, ASR enables the refresh rate to automatically adjust between 1x to 2x over the supported temperature range. One other disadvantage with ASR is the DRAM cannot always switch from a 1x to a 2x refresh rate at an exact case temperature of 85°C. Although the DRAM will support data integrity when it switches from a 1x to a 2x refresh rate, it may switch at a lower temperature than 85°C. Since only one mode is necessary, SRT and ASR cannot be enabled at the same time.

### DYNAMIC ODT

The dynamic ODT (RTT(WR)) feature is defined by MR2[10,9]. Dynamic ODT is enabled when a value is selected. This new DDR3 SDRAM feature enables the ODT termination value to change without issuing an MRS command, essentially changing the ODT termination on-the-fly. With dynamic ODT(RTT(WR)) enabled, the DRAM switches from normal ODT(RTT,nom) to dynamic ODT (RTT(WR)) when beginning a WRITE burst and subsequently switches back to ODT(RTT,nom) at the completion of the WRITE burst. If RTT,nom is disabled, the RTT,nom value will be High-Z.





Special timing parameters must be adhered to when dynamic ODT (RTT(WR)) is enabled: ODTLcnw, ODTLcnw4, ODTLcnw8, ODTTH4, ODTTH8, and tADC. Dynamic ODT is only applicable during WRITE cycles. If ODT(RTT,nom) is disabled, dynamic ODT (RTT(WR)) is still permitted. RTT,nom and RTT(WR) can be used independent of one other. Dynamic ODT is not available during write leveling mode, regardless of the state of ODT(RTT,nom). For details on dynamic ODT operation, refer to Dynamic ODT.

### Mode Register 3 (MR3)

The mode register 3 (MR3) controls additional functions and features not available in the other mode registers. Currently defined is the MULTIPURPOSE REGISTER(MPR). This function is controlled via the bits shown. The MR3 is programmed via the LOAD MODE command and retains the stored information until it is programmed again or until the device loses power. Reprogramming the MR3 register will not alter the contents of the memory array, provided it is performed correctly. The MR3 register must be loaded when all banks are idle and no data bursts are in progress, and the controller must wait the specified time tMRD and tMOD before initiating a sub-sequent operation.

#### Mode Register 3 (MR3) Definition

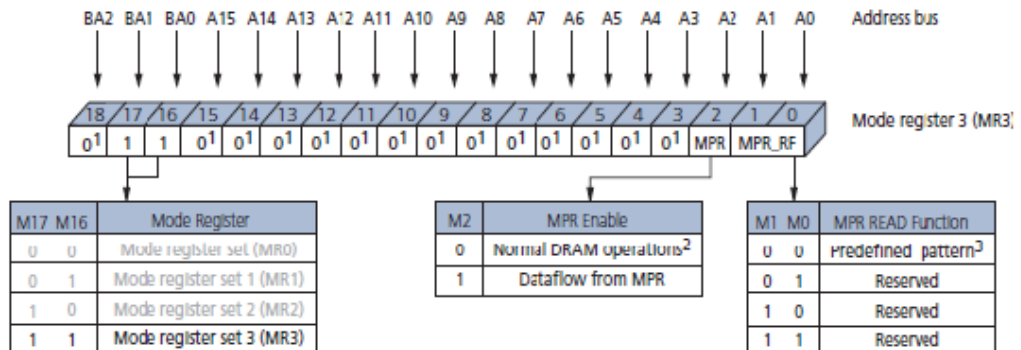

Notes:	1	MR3[18 and 15:3] are reserved for future use and must all be programmed to 0.
	2	When MPR control is set for normal DRAM operation, MR3[1, 0] will be ignored.
	3	Intended to be used for READ synchronization.

### MULTIPURPOSE REGISTER (MPR)

The MULTIPURPOSE REGISTER function is used to output a predefined system timing calibration bit sequence. Bit 2 is the master bit that enables or disables access to the MPR register, and bits 1 and 0 determine which mode the MPR is placed in. The basic concept of the multipurpose register is shown. If MR3[2] is a 0,



then the MPR access is disabled, and the DRAM operates in normal mode. However, if MR3[2] is a 1, then the DRAM no longer outputs normal read data but outputs MPR data as defined by MR3[0,1]. If MR3[0,1] is equal to 00, then a predefined read pattern for system calibration is selected. To enable the MPR, the MRS command is issued to MR3, and MR3[2]=1. Prior to issuing the MRS command, all banks must be in the idle state (all banks are precharged, and tRP is met). When the MPR is enabled, any subsequent READ or RDAP commands are redirected to the multipurpose register. The resulting operation when either a READ or a RDAP command is issued, is defined by MR3 [1:0] when the MPR is enabled. When the MPR is enabled, only READ or RDAP commands are allowed until a subsequent MRS command is issued with the MPR disabled(MR3[2] =0). Power down mode, self refresh, and any other non READ/RDAP commands are not allowed during MPR enable mode. The RESET function is supported during MPR enable mode.



**Multipurpose Register (MPR) Block Diagram**

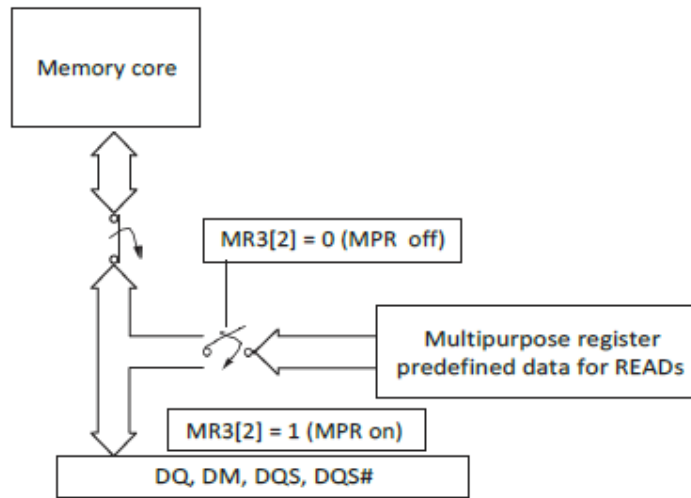

- Notes: 1. A predefined data pattern can be read out of the MPR with an external READ command.  
 2. MR3[2] defines whether the data flow comes from the memory core or the MPR. When the data flow is defined, the MPR contents can be read out continuously with a regular READ or RDAP command.

**MPR Functional Description of MR3 Bits**

MR3[2]	MR3[1:0]	Function
MPR	MPR READ Function	
0	"Don't Care"	Normal operation, no MPR transaction All subsequent READs come from the DRAM memory array All subsequent WRITES go to the DRAM memory array
1	A[1:0]	Enable MPR mode, subsequent READ/RDAP commands defined by bits 1 and 2

**MPR Functional Description**

The MPR JEDEC definition enables either a prime DQ (DQ0 on a x4 and a x8; on a x16, DQ0= lower byte and DQ8 = upper byte) to output the MPR data with the remaining DQs driven LOW, or for all DQs output the MPR data. The MPR read out supports fixed READ burst and READ burst chop (MRS and OTF via A12/BC#) with regular READ latencies and AC timings applicable, provided the DLL is locked as required.

MPR addressing for a valid MPR read is as follows:

- A[1:0] must be set to 00 as the burst order is fixed per nibble
- A2 selects the burst order:
  - BL8, A2 is set to 0, and the burst order is fixed to 0, 1, 2, 3, 4, 5, 6, 7
- For burst chop 4 cases, the burst order is switched on the nibble base along



with the following:

- A2 = 0; burst order = 0, 1, 2, 3
- A2 = 1; burst order = 4, 5, 6, 7
- Burst order bit 0 (the first bit) is assigned to LSB, and burst order bit 7(the last bit) is assigned to MSB
- A[9:3] are a “Don’t Care”
- A10 is a “Don’t Care”
- A11 is a “Don’t Care”
- A12: Selects burst chop mode on-the-fly, if enabled within MR0
- A13 is a “Don’t Care”
- BA[2:0] are a “Don’t Care”

**MPR Register Address Definitions and Bursting Order**

The MPR currently supports a single data format. This data format is a predefined read pattern for system calibration. The predefined pattern is always a repeating 0-1 bit pattern. Examples of the different types of predefined READ pattern bursts are shown in the following figures.

**MPR Readouts and Burst Order Bit Mapping**

MR3[2]	MR3[1:0]	Function	Burst Length	Read A[2:0]	Burst Order and Data Pattern
1	00	READ predefined pattern for system calibration	BL8	000	Burst order: 0, 1, 2, 3, 4, 5, 6, 7 Predefined pattern: 0, 1, 0, 1, 0, 1, 0, 1
			BC4	000	Burst order: 0, 1, 2, 3 Predefined pattern: 0, 1, 0, 1
			BC4	100	Burst order: 4, 5, 6, 7 Predefined pattern: 0, 1, 0, 1
1	01	RFU	N/A	N/A	N/A
			N/A	N/A	N/A
			N/A	N/A	N/A
1	10	RFU	N/A	N/A	N/A
			N/A	N/A	N/A
			N/A	N/A	N/A

**MPR Readouts and Burst Order Bit Mapping (Continued)**

MR3[2]	MR3[1:0]	Function	Burst Length	Read A[2:0]	Burst Order and Data Pattern
1	11	RFU	N/A	N/A	N/A
			N/A	N/A	N/A
			N/A	N/A	N/A

Note: 1. Burst order bit 0 is assigned to LSB, and burst order bit 7 is assigned to MSB of the selected MPR agent.



**MPR System Read Calibration with BL8: Fixed Burst Order Single Readout**

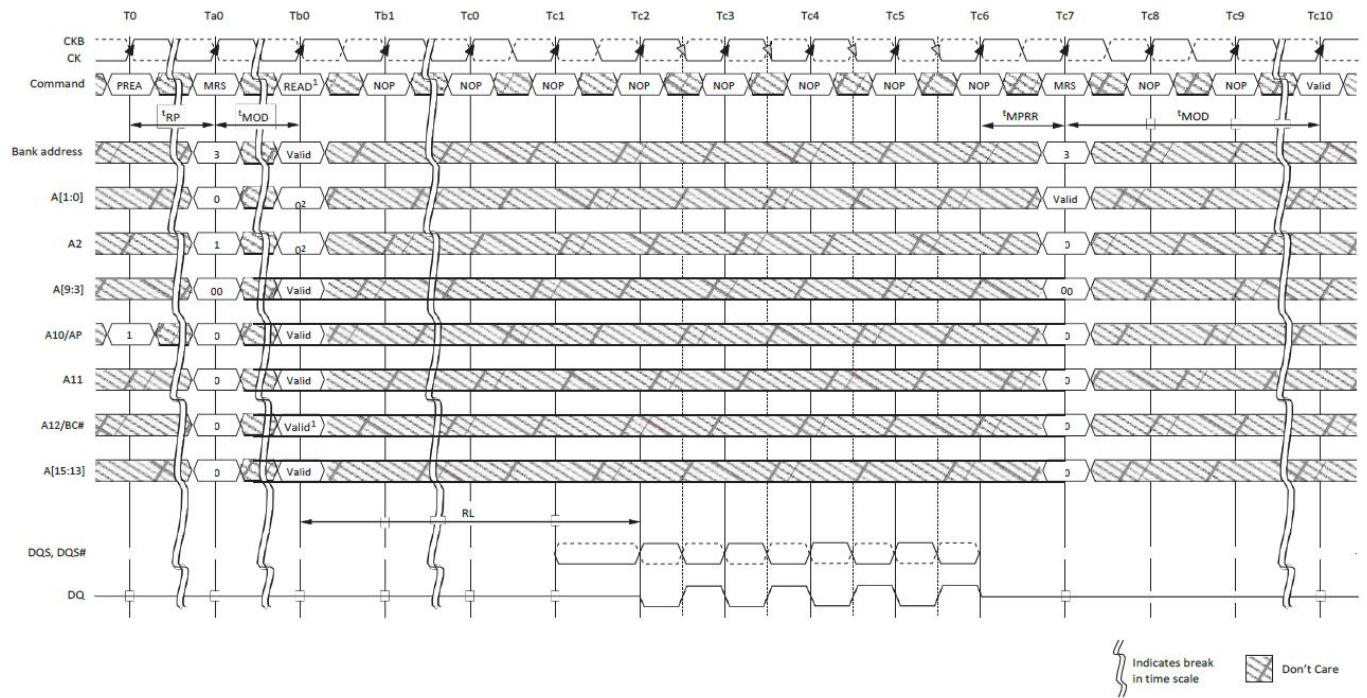

- Notes:
1. READ with BL8 either by MRS or OTF.
  2. Memory controller must drive 0 on A[2:0].



**MPR System Read Calibration with BL8: Fixed Burst Order, Back-to-Back Readout**

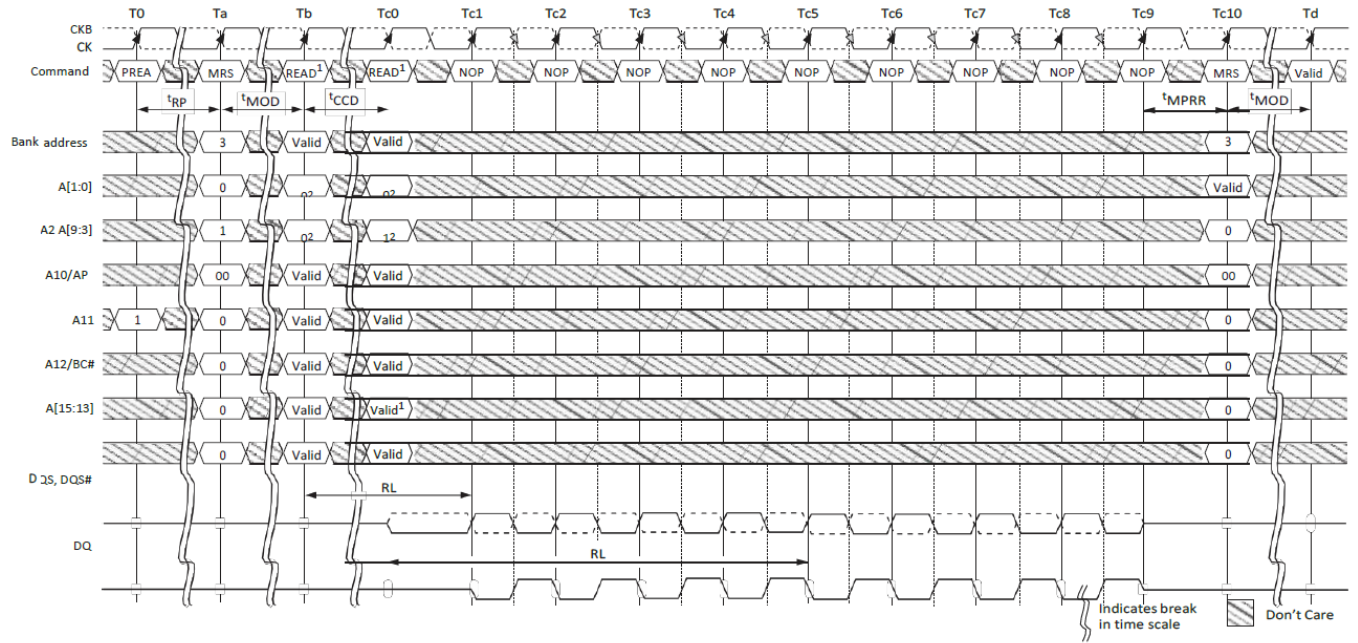

- Notes: 1. READ with BL8 either by MRS or OTF.  
2. Memory controller must drive 0 on A [2:0].



**MPR System Read Calibration with BC4: Lower Nibble, Then Upper Nibble**

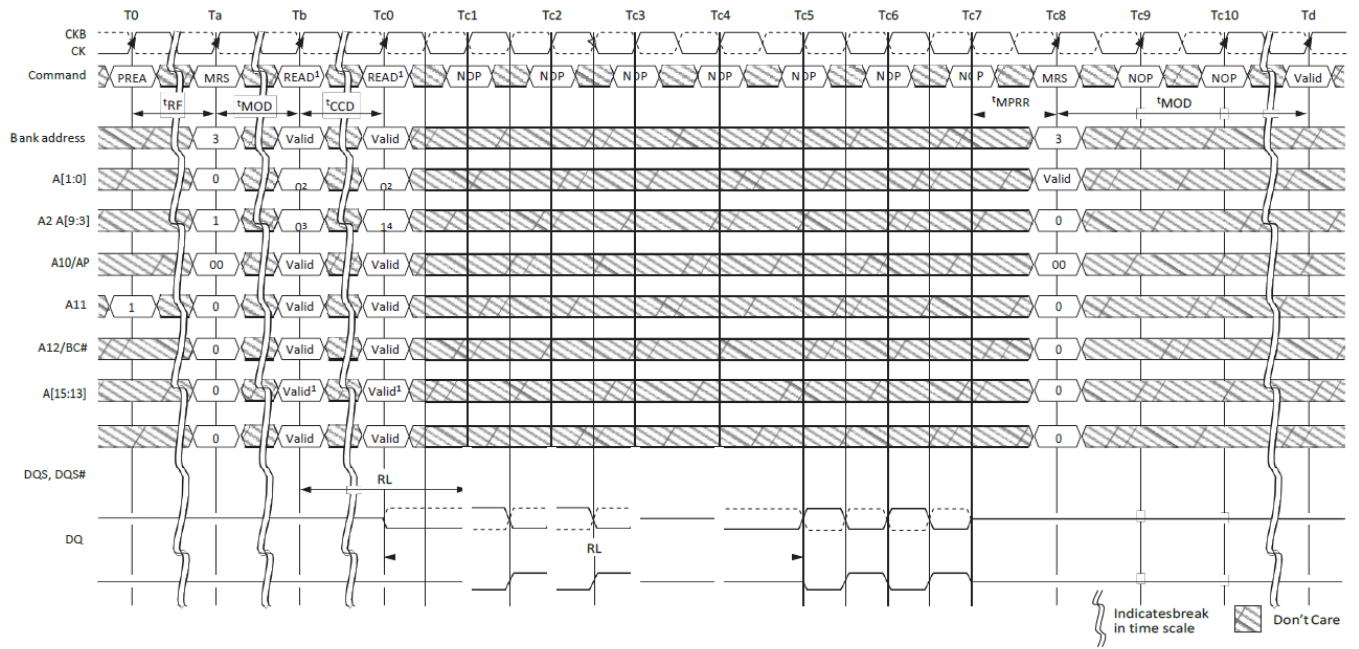

- Notes:
1. READ with BC4 either by MRS or OTF.
  2. Memory controller must drive 0 on A [1:0].
  3. A2 = 0 selects lower 4 nibble bits 0 . . . 3.
  4. A2 = 1 selects upper 4 nibble bits 4 . . . 7.



**MPR System Read Calibration with BC4: Upper Nibble, Then Lower Nibble**

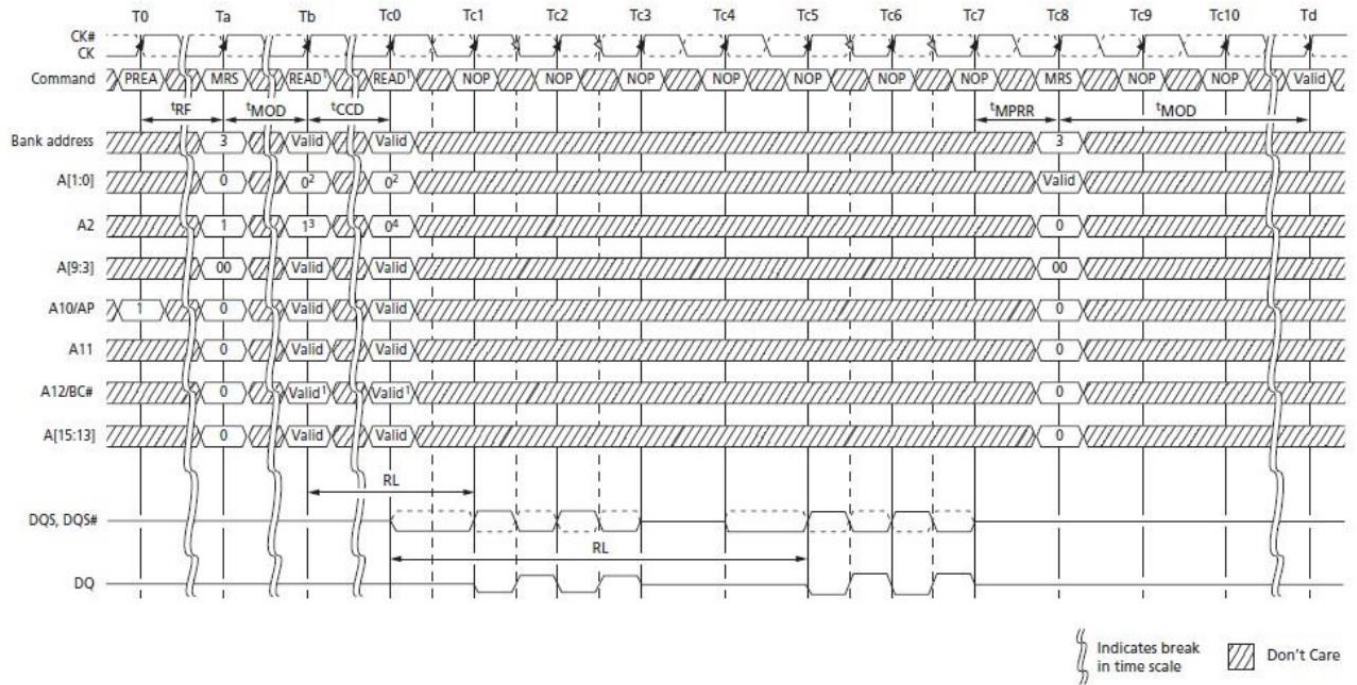

- Notes:
1. READ with BC4 either by MRS or OTF.
  2. Memory controller must drive 0 on A [1:0].
  3. A2 = 1 selects upper 4 nibble bits 4 . . . 7.
  4. A2 = 0 selects lower 4 nibble bits 0 . . . 3.

**MPR Read Predefined Pattern**

The predetermined read calibration pattern is a fixed pattern of 0, 1, 0, 1, 0, 1, 0, 1 .  
The following is an example of using the read out predetermined read calibration





pattern. The example is to perform multiple reads from the multipurpose register to do system level read timing calibration based on the predetermined and standardized pattern. The following protocol outlines the steps used to perform the read calibration:

1. Precharge all banks
2. After tRP is satisfied, set MRS, MR3 [2] = 1 and MR3 [1:0] = 00. This redirects all sub-sequent reads and loads the predefined pattern into the MPR. As soon as tMRD and tMOD are satisfied, the MPR is available
3. Data WRITE operations are not allowed until the MPR returns to the normal DRAM state
4. Issue a read with burst order information (all other address pins are “Don’t Care”):
  - A[1:0] = 00 (data burst order is fixed starting at nibble)
  - A2=0(for BL8,burst order is fixed as 0,1,2,3,4,5,6,7)
  - A12 = 1 (use BL8)
5. After RL = AL + CL, the DRAM bursts out the predefined read calibration pattern (0,1,0,1,0,1,0,1)
6. The memory controller repeats the calibration reads until read data capture at memory controller is optimized
7. After the last MPR READ burst and after tMPRR has been satisfied, issue MRS, MR3 [2] = 0, and MR3[1:0] = “Don’t Care” to the normal DRAM state. All subsequent read and write accesses will be regular reads and writes from/to the DRAM array
8. When tMRD and tMOD are satisfied from the last MRS, the regular DRAM commands (such as activate a memory bank for regular read or write access) are permitted

#### **MODE REGISTER SET (MRS) Command**

The mode registers are loaded via inputs BA [2:0], A[13:0]. BA [2:0] determine which mode register is programmed:

- BA2 = 0, BA1 = 0, BA0 = 0 for MR0
- BA2 = 0, BA1 = 0, BA0 = 1 for MR1
- BA2 = 0, BA1 = 1, BA0 = 0 for MR2
- BA2 = 0, BA1 = 1, BA0 = 1 for MR3

The MRS command can only be issued (or re-issued) when all banks are idle and in the precharged state(tRP is satisfied and no data bursts are in progress).The controller must wait the specified time tMRD before initiating a subsequent operation such as an ACTIVATE command. There is also a restriction after issuing an MRS command with regard to when the updated functions become available. This parameter is specified by tMOD. Both tMRD and tMOD parameters are shown. Violating either of these requirements will result in unspecified operation.



## 16. Operation

### 16.1 ZQ CALIBRATION Operation

The ZQ CALIBRATION command is used to calibrate the DRAM output drivers (RON) and ODT values (RTT) over process, voltage, and temperature, provided a dedicated  $240\Omega$  ( $\pm 1\%$ ) external resistor is connected from the DRAM's ZQ ball to VSSQ. DDR3 SDRAM require a longer time to calibrate RON and ODT at power-up initialization and self refresh exit, and a relatively shorter time to perform periodic calibrations. DDR3 SDRAM defines two ZQ CALIBRATION commands: ZQCL and ZQCS. An example of ZQ calibration timing is shown below. All banks must be precharged and  $t_{RP}$  must be met before ZQCL or ZQCS commands can be issued to the DRAM. No other activities (other than issuing another ZQCL or ZQCS command) can be performed on the DRAM channel by the controller for the duration of  $t_{ZQinit}$  or  $t_{ZQoper}$ . The quiet time on the DRAM channel helps accurately calibrate RON and ODT. After DRAM calibration is achieved, the DRAM should disable the ZQ ball's current consumption path to reduce power. ZQ CALIBRATION commands can be issued in parallel to DLL RESET and locking time. Upon self refresh exit, an explicit ZQCL is required if ZQ calibration is desired. In dual-rank systems that share the ZQ resistor between devices, the controller must not enable overlap of  $t_{ZQinit}$ ,  $t_{ZQoper}$ , or  $t_{ZQCS}$  between ranks.

ZQ CALIBRATION Timing (ZQCL and ZQCS)

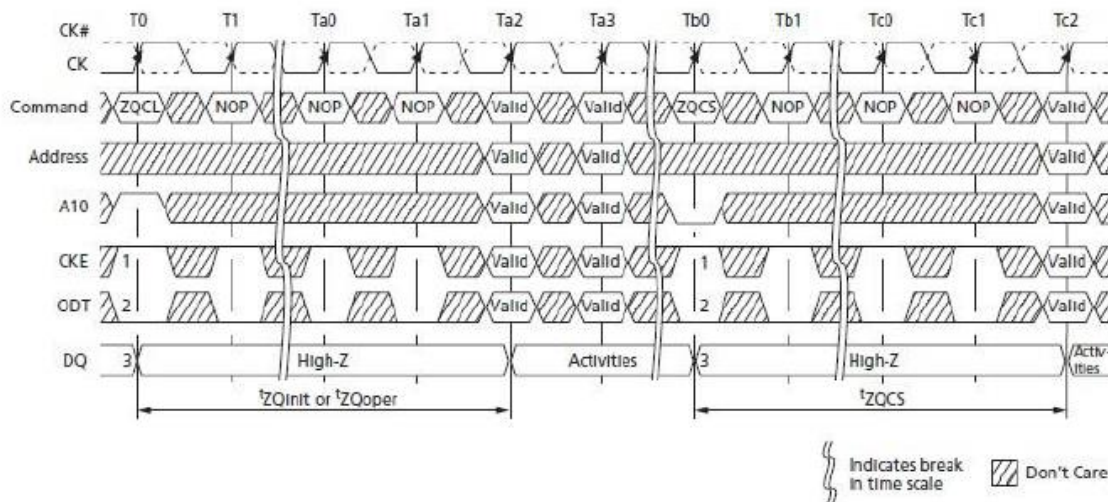

- Notes:
1. CKE must be continuously registered HIGH during the calibration procedure.
  2. ODT must be disabled via the ODT signal or the MRS during the calibration procedure.
  3. All devices connected to the DQ bus should be High-Z during calibration.



## 16.2 ACTIVATE Operation

Before any READ or WRITE commands can be issued to a bank within the DRAM, a row in that bank must be opened (activated). This is accomplished via the ACTIVATE command, which selects both the bank and the row to be activated. After a row is opened with an ACTIVATE command, a READ or WRITE command may be issued to that row, subject to the tRCD specification. However, if the additive latency is programmed correctly, a READ or WRITE command may be issued prior to tRCD (MIN). In this operation, the DRAM enables a READ or WRITE command to be issued after the ACTIVATE command for that bank, but prior to tRCD(MIN) with the requirement that (ACTIVATE-to-READ/WRITE) + AL ≥ tRCD(MIN) (see Posted CAS Additive Latency). tRCD (MIN) should be divided by the clock period and rounded up to the next whole number to determine the earliest clock edge after the ACTIVATE command on which a READ or WRITE command can be entered. The same procedure is used to convert other specification limits from time units to clock cycles. When at least one bank is open, any READ-to-READ command delay or WRITE-to-WRITE command delay is restricted to tCCD (MIN). A subsequent ACTIVATE command to a different row in the same bank can only be issued after the previous active row has been closed (precharged). The minimum time interval between successive ACTIVATE commands to the same bank is defined by tRC. A subsequent ACTIVATE command to another bank can be issued while the first bank is being accessed, which results in a reduction of total row-access overhead. The minimum time interval between successive ACTIVATE commands to different banks is defined by tRRD. No more than four bank ACTIVATE commands may be issued in a given tFAW(MIN) period, and the tRRD (MIN) restriction still applies. The tFAW(MIN) parameter applies, regardless of the number of banks already opened or closed.

Example: Meeting tRRD (MIN) and tRCD (MIN)

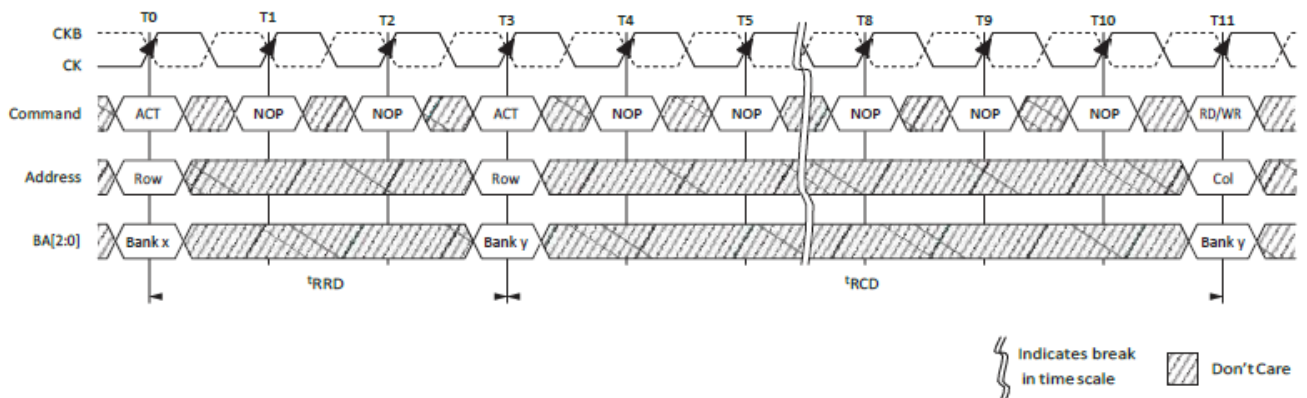

**Example:  $t_{FAW}$**

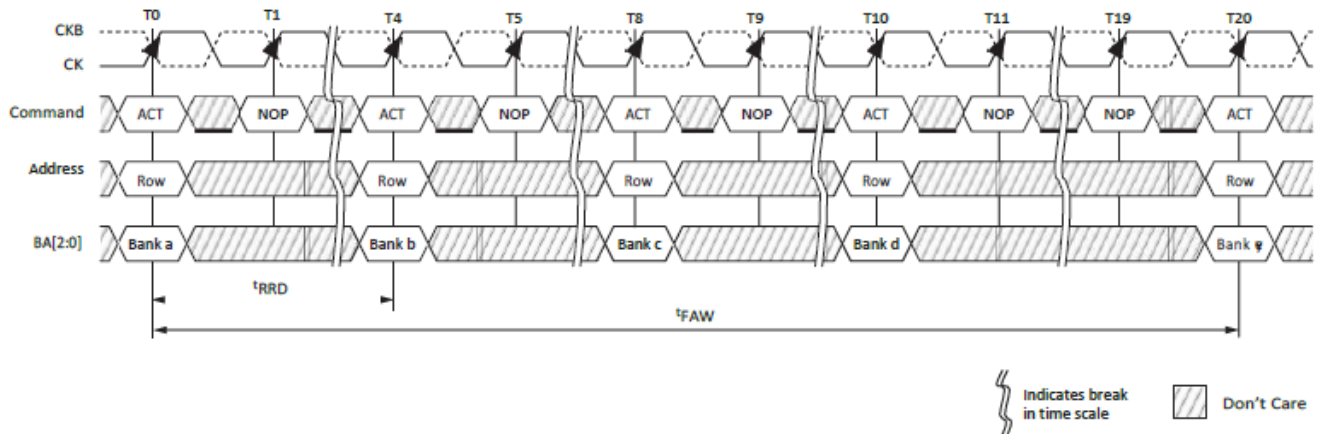

### 16.3 READ Operation

READ bursts are initiated with a READ command. The starting column and bank addresses are provided with the READ command and auto precharge is either enabled or disabled for that burst access. If auto precharge is enabled, the row being accessed is automatically precharged at the completion of the burst. If auto precharge is disabled, the row will be left open after the completion of the burst. During READ bursts, the valid data-out element from the starting column address is available READ latency (RL) clocks later. RL is defined as the sum of posted CAS additive latency(AL) and CAS latency(CL) ( $RL=AL+ CL$ ).The value of AL and CL is programmable in the mode register via the MRS command. Each subsequent data-out element is valid nominally at the next positive or negative clock edge (that is, at the next crossing of CK and CKB). Shows an example of RL based on a CL setting of 8 and an AL setting of 0.



### READ Latency

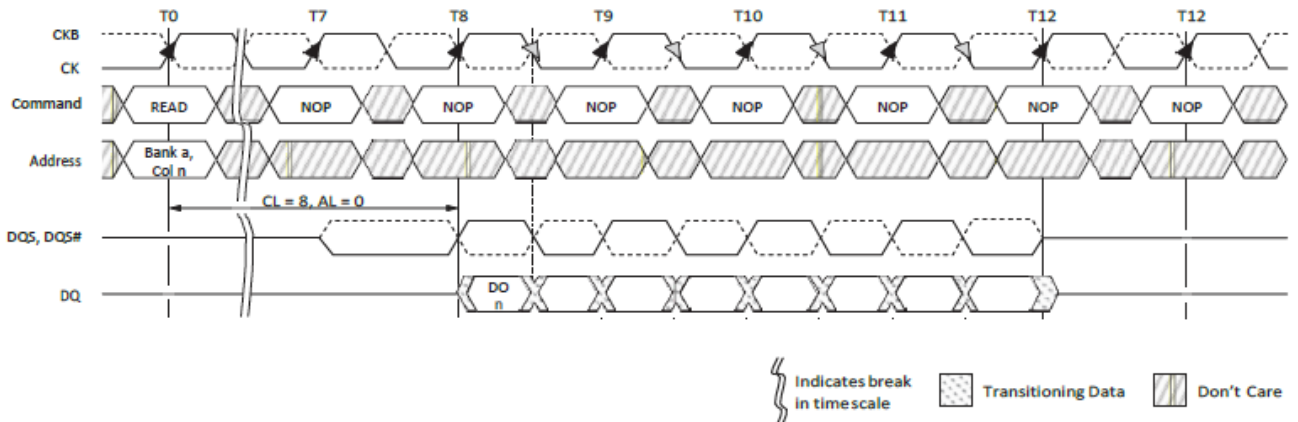

- Notes: 1. DO  $n$  = data-out from column  $n$ .  
2. Subsequent elements of data-out appear in the programmed order following DO  $n$ .

DQS,DQS# is driven by the DRAM along with the output data. The initial LOW state on DQS and HIGH state on DQS# is known as the READ preamble ( $t_{RPRE}$ ). The LOW state on DQS and the HIGH state on DQS#, coincident with the last data-out element, is known as the READ postamble ( $t_{RPST}$ ). Upon completion of a burst, assuming no other commands have been initiated, the DQ goes High-Z. A detailed explanation of  $t_{DQSQ}$  (valid data-out skew),  $t_{QH}$  (data-out window hold), and the valid data window are depicted. A detailed explanation of  $t_{DQSCK}$  (DQS transition skew to CK) is also depicted). Data from any READ burst may be concatenated with data from a subsequent READ command to provide a continuous flow of data. The first data element from the new burst follows the last element of a completed burst. The new READ command should be issued  $t_{CCD}$  cycles after the first READ command. This is shown for BL8. If BC4 is enabled,  $t_{CCD}$  must still be met, which will cause a gap in the data output, as shown. Nonconsecutive READ data is reflected. DDR3 SDRAM does not allow interrupting or truncating any READ burst. Data from any READ burst must be completed before a subsequent WRITE burst is allowed. An example of a READ burst followed by a WRITE burst for BL8 is shown in (BC4 is shown). To ensure the READ data is completed before the WRITE data is on the bus, the minimum READ-to-WRITE timing is  $RL + t_{CCD} - WL + 2t_{CK}$ . A READ burst may be followed by a PRECHARGE command to the same bank, provided auto precharge is not activated. The minimum READ-to-PRECHARGE command spacing to the same bank is four clocks and must also satisfy a minimum analog time from the READ command. This time is called  $t_{RTP}$  (READ-to-PRECHARGE).  $t_{RTP}$  starts AL cycles later than the READ command. Examples for BL8 are shown and BC4. Following the PRECHARGE command, a subsequent command to the same bank cannot be issued until  $t_{RP}$  is met. The PRECHARGE command followed by another PRECHARGE command to the same bank is allowed. However, the precharge period will be determined by the last PRECHARGE command issued to the bank. If A10 is HIGH



when a READ command is issued, the READ with auto precharge function is engaged. The DRAM starts an auto precharge operation on the rising edge, which is  $AL + tRTP$  cycles after the READ command. DRAM support atRAS lockout feature. If  $tRAS(MIN)$  is not satisfied at the edge, the starting point of the auto precharge operation will be delayed until  $tRAS(MIN)$  is satisfied. If  $tRTP (MIN)$  is not satisfied at the edge, the starting point of the auto precharge operation is delayed until  $tRTP (MIN)$  is satisfied. In case the internal precharge is pushed out by  $tRTP$ ,  $tRP$  starts at the point at which the internal precharge happens (not at the next rising clock edge after this event). The time from READ with auto precharge to the next ACTIVATE command to the same bank is  $AL+(tRTP+tRP)^*$ , where \*means rounded up to the next integer. In any event, internal precharge does not start earlier than four clocks after the last  $8n$ -bit prefetch.



**Consecutive READ Bursts (BL8)**

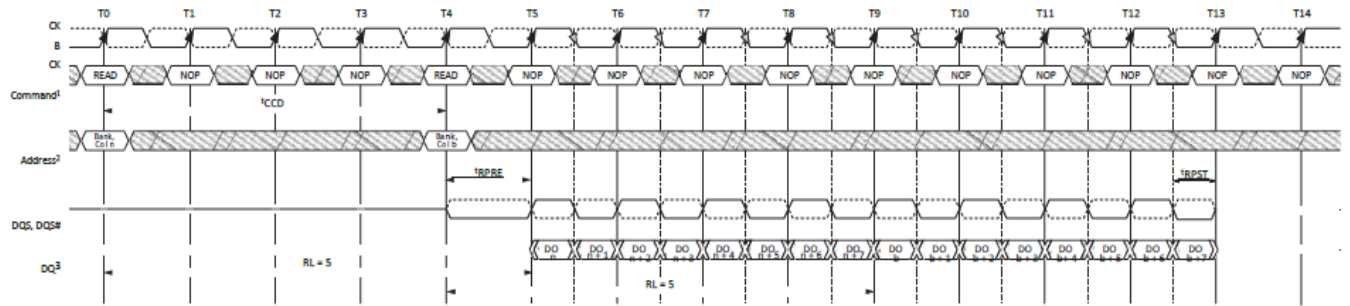

- Notes:
1. NOP commands are shown for ease of illustration; other commands may be valid at these times.
  2. The BL8 setting is activated by either  $MRO[1:0] = 00$  or  $MRO[1:0] = 01$  and  $A12 = 1$  during READ command at T0 and T4.
  3.  $DO_n$  (or  $b$ ) = data-out from column  $n$  (or column  $b$ ).
  4. BL8, RL = 5 (CL = 5, AL = 0).

**Consecutive READ Bursts (BC4)**

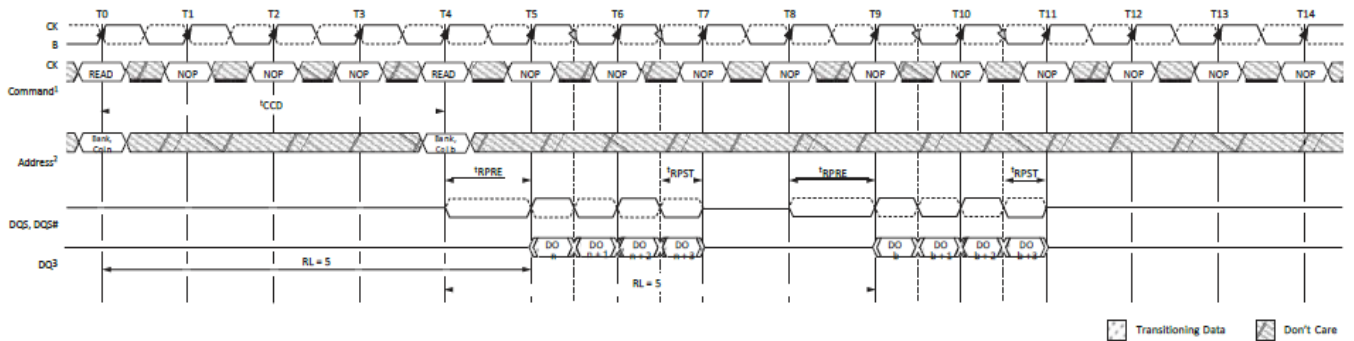

- Notes:
1. NOP commands are shown for ease of illustration; other commands may be valid at these times.
  2. The BC4 setting is activated by either  $MRO[1:0] = 10$  or  $MRO[1:0] = 01$  and  $A12 = 0$  during READ command at T0 and T4.
  3.  $DO_n$  (or  $b$ ) = data-out from column  $n$  (or column  $b$ ).
  4. BC4, RL = 5 (CL = 5, AL = 0).



**Nonconsecutive READ Bursts**

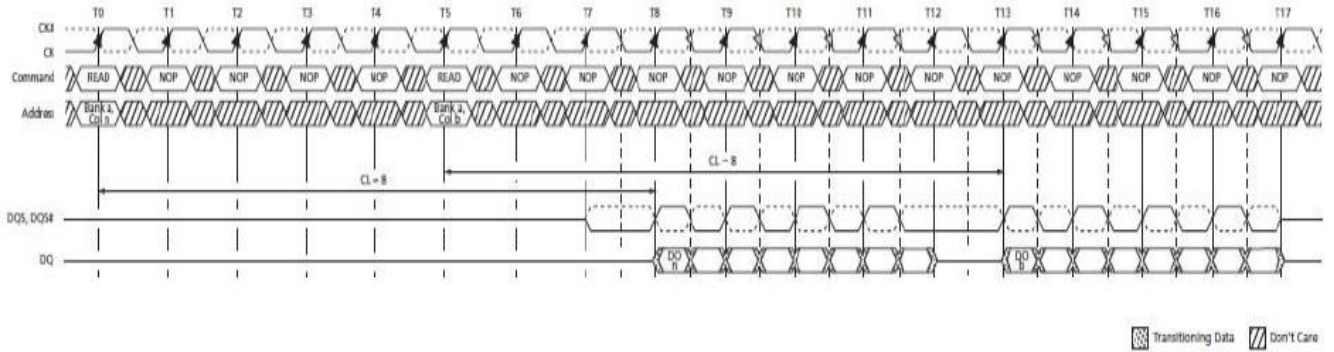

- Notes:
1. AL = 0, RL = 8.
  2. DO *n* (or *b*) = data-out from column *n* (or column *b*).
  3. Seven subsequent elements of data-out appear in the programmed order following DO *n*.
  4. Seven subsequent elements of data-out appear in the programmed order following DO *b*.

**READ (BL8) to WRITE (BL8)**

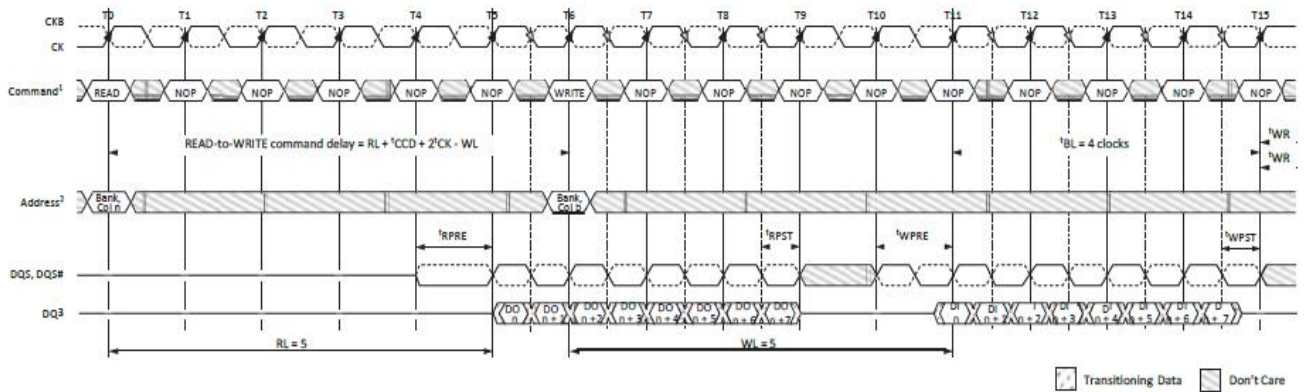

- Notes:
1. NOP commands are shown for ease of illustration; other commands may be valid at these times.
  2. The BL8 setting is activated by either MRO[1:0] = 00 or MRO[1:0] = 01 and A12 = 1 during the READ command at T0, and the WRITE command at T6.
  3. DO *n* = data-out from column, DI *b* = data-in for column *b*.
  4. BL8, RL = 5 (AL = 0, CL = 5), WL = 5 (AL = 0, CWL = 5).





**READ (BC4) to WRITE (BC4) OTF**

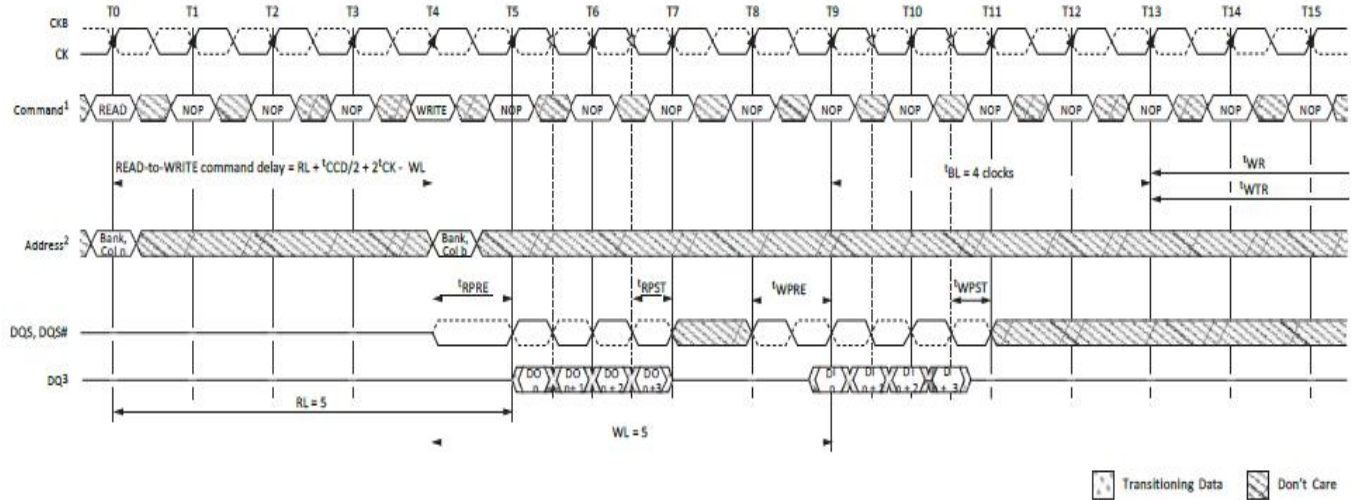

- Notes:
1. NOP commands are shown for ease of illustration; other commands may be valid at these times.
  2. The BC4 OTF setting is activated by  $M0[1:0]$  and  $A12 = 0$  during READ command at T0 and WRITE command at T4.
  3.  $DO\ n =$  data-out from column  $n$ ;  $DI\ n =$  data-in from column  $b$ .
  4. BC4,  $RL = 5$  ( $AL = 0, CL = 5$ ),  $WL = 5$  ( $AL = 0, CWL = 5$ ).

**READ to PRECHARGE (BL8)**

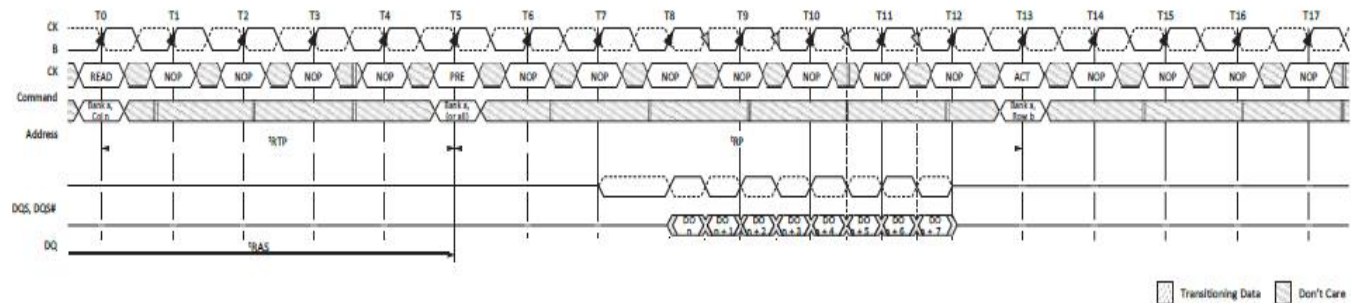

**READ to PRECHARGE (BC4)**

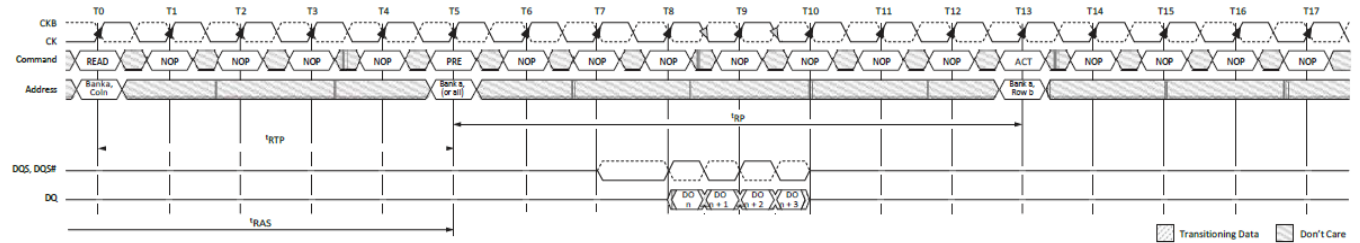

**READ to PRECHARGE (AL = 5, CL = 6)**

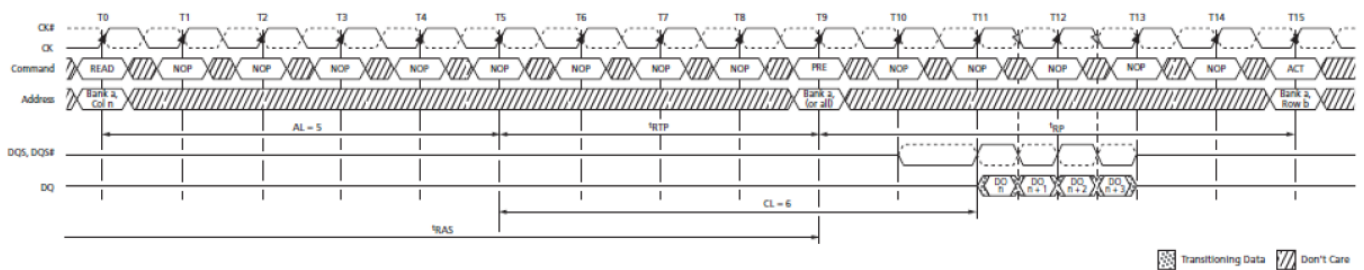

**READ with Auto Precharge (AL = 4, CL = 6)**

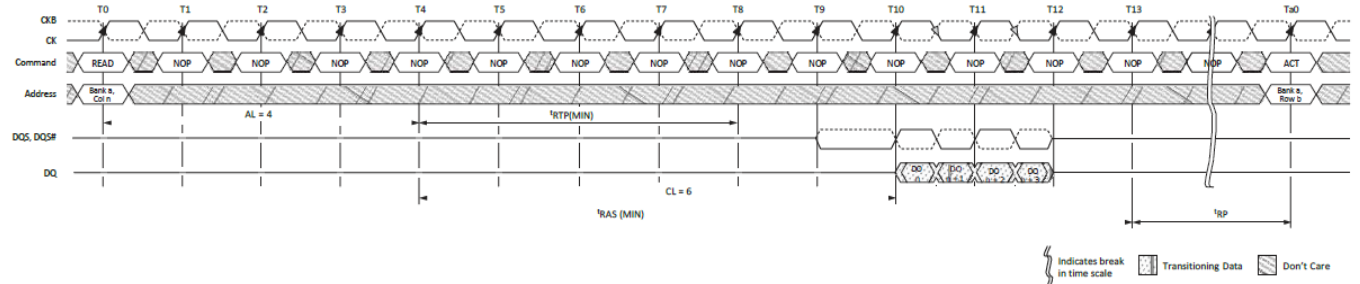

DQS to DQ output timing is shown in. The DQ transitions between valid data outputs must be within tDQSQ of the crossing point of DQS, DQS#. DQS must also maintain a minimum HIGH and LOW time of tQSH and tQSL. Prior to the READ preamble, the DQ balls will either be floating or terminated, depending on the status of the ODT signal. Shows the strobe-to-clock timing during a READ. The crossing point DQS, DQS# must transition within ± tDQSK of the clock crossing point. The data out has no timing relationship to CK, only to DQS, as shown. Also shows the READ preamble and postamble. Typically, both DQS and DQS# are High-Z to save power (VDDQ). Prior to data output from the DRAM, DQS is driven LOW and DQS# is HIGH for tRPRE. This is known as the READ preamble. The READ postamble, tRPST, is one half clock from the last DQS, DQS# transition. During the READ postamble, DQS is driven LOW and DQS# is HIGH. When complete, the DQ is disabled or continues terminating, depending on the state of the ODT signal. demonstrates how to measure tRPST.



Data Output Timing – tDQSQ and Data Valid Window

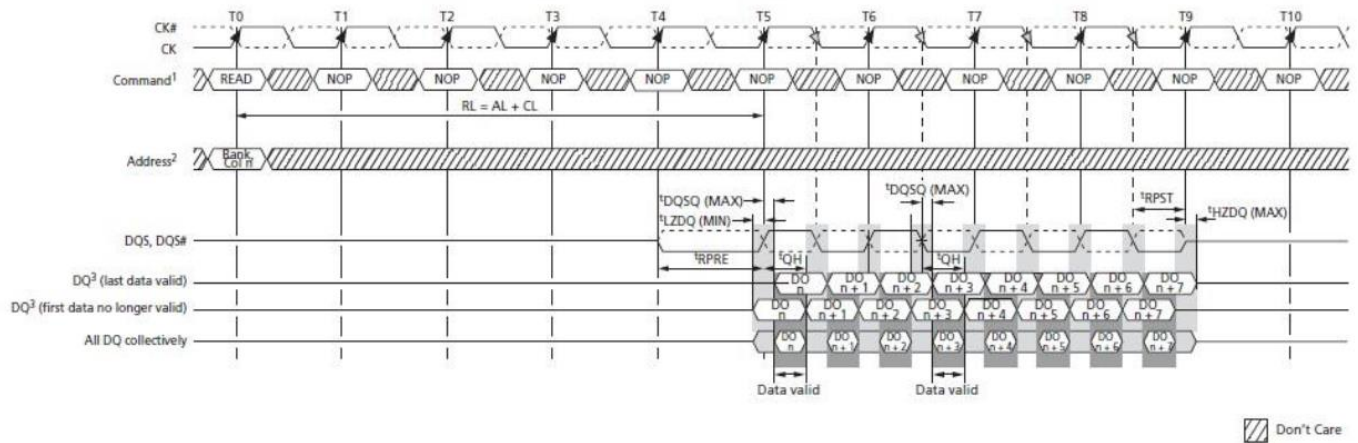

- Notes:
1. NOP commands are shown for ease of illustration; other commands may be valid at these times.
  2. The BL8 setting is activated by either MR0[1, 0] = 0, 0 or MR0[0, 1] = 0, 1 and A12 = 1 during READ command at T0.
  3. DO<sub>n</sub> = data-out from column.
  4. BL8, RL = 5 (AL = 0, CL = 5)
  5. Output timings are referenced to VDDQ/2 and DLL on and locked.
  6. tDQSQ defines the skew between DQS, DQS# to data and does not define DQS, DQS# to CK.
  7. Early data transitions may not always happen at the same DQ. Data transitions of a DQ can be early or late within a burst.
- tHZ and tLZ transitions occur in the same access time as valid data transitions. These parameters are referenced to a specific voltage level that specifies when the device output is no longer driving tHZDQS and tHZDQ, or begins driving tLZDQS, tLZDQ. tHZDQS and tHZDQ shows a method of calculating the point when the device is no longer driving tHZDQS and tHZDQ, or begins driving tLZDQS, tLZDQ, by measuring the signal at two different voltages. The actual voltage measurement points are not critical as long as the calculation is consistent. The parameters tLZDQS, tLZDQ, tHZDQS, and tHZDQ are defined as single-ended.



Data Strobe Timing – READs

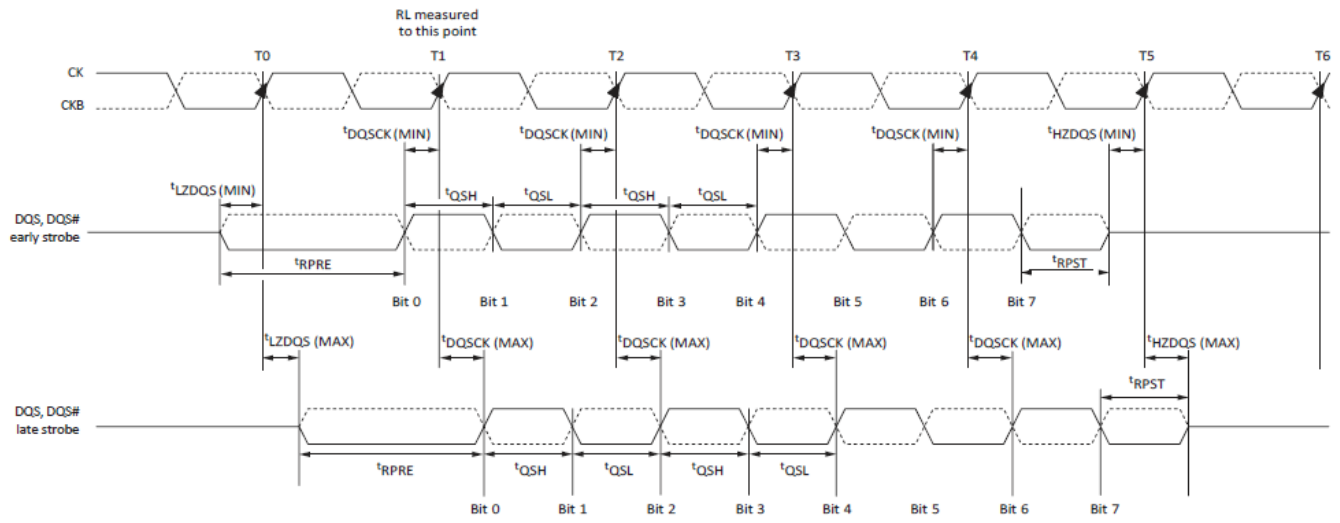

**Method for Calculating  $t_{LZ}$  and  $t_{HZ}$**

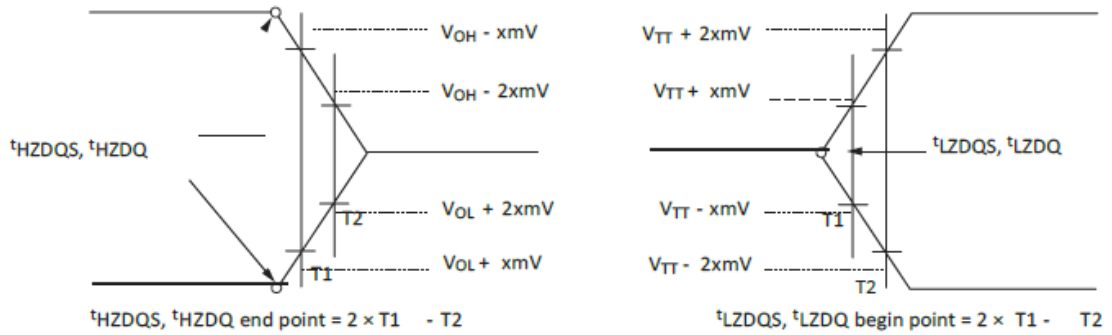

- Notes:
1. Within a burst, the rising strobe edge is not necessarily fixed at  $t_{DQSK} (MIN)$  or  $t_{DQSK} (MAX)$ . Instead, the rising strobe edge can vary between  $t_{DQSK} (MIN)$  and  $t_{DQSK} (MAX)$ .
  2. The QQS HIGH pulse width is defined by  $t_{QSH}$ , and the DQS LOW pulse width is defined by  $t_{QSL}$ . Likewise,  $t_{LZDQS} (MIN)$  and  $t_{HZDQS} (MIN)$  are not tied to  $t_{DQSK} (MIN)$  (early strobe case), and  $t_{LZDQS} (MAX)$  and  $t_{HZDQS} (MAX)$  are not tied to  $t_{DQSK} (MAX)$  (late strobe case); however, they tend to track one another.
  3. The minimum pulse width of the READ preamble is defined by  $t_{RPRE} (MIN)$ . The minimum pulse width of the READ postamble is defined by  $t_{RPST} (MIN)$ .

**$t_{RPRE}$  Timing**

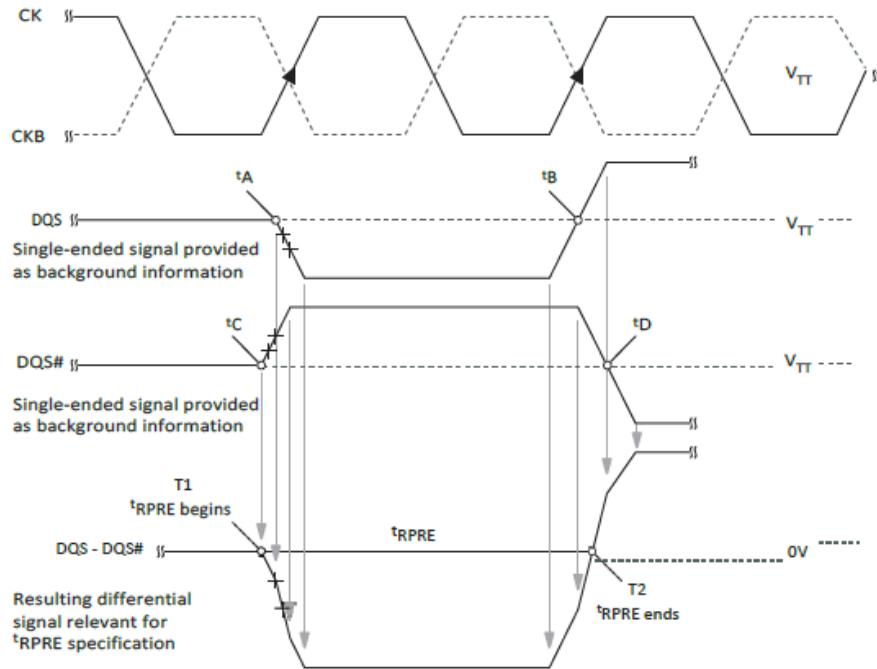

<sup>t</sup>RPST Timing

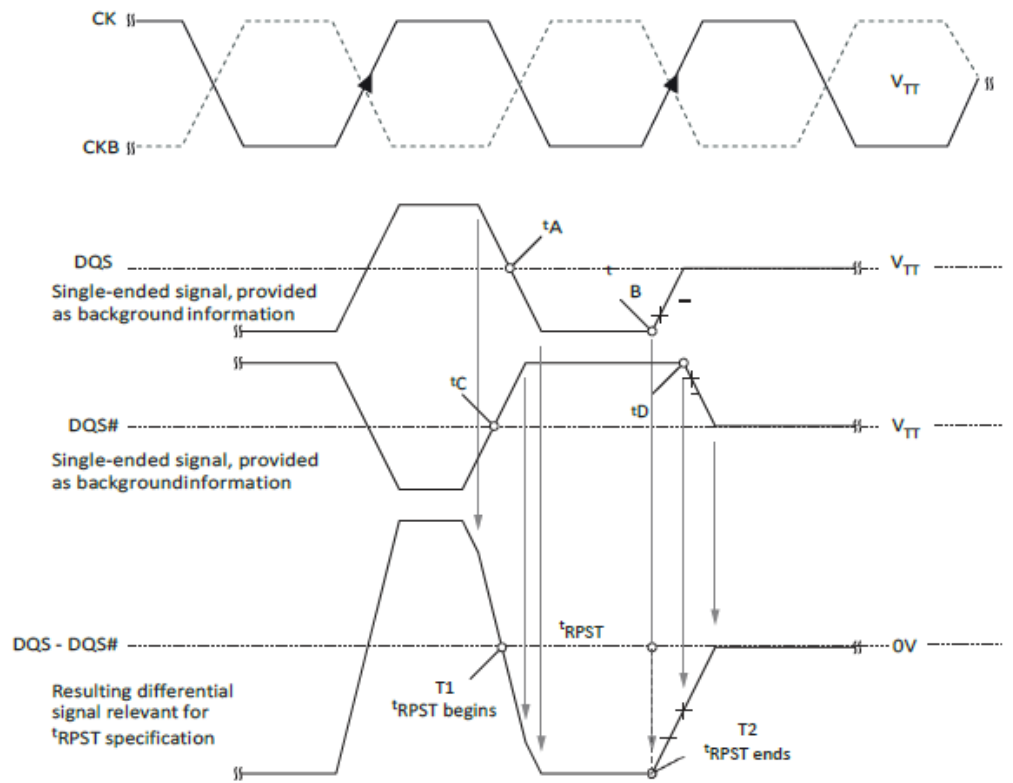

CONFIDENTIAL



## 16.4 WRITE Operation

WRITE bursts are initiated with a WRITE command. The starting column and bank addresses are provided with the WRITE command, and auto precharge is either enabled or disabled for that access. If auto precharge is selected, the row being accessed is precharged at the end of the WRITE burst. If auto precharge is not selected, the row will remain open for subsequent accesses. After a WRITE command has been issued, the WRITE burst may not be interrupted. For the generic WRITE commands used through, auto precharge is disabled. During WRITE bursts, the first valid data-in element is registered on a rising edge of DQS following the WRITE latency (WL) clocks later and subsequent data elements will be registered on successive edges of DQS. WRITE latency (WL) is defined as the sum of posted CAS additive latency (AL) and CASWRITE latency (CWL):  $WL = AL + CWL$ . The values of AL and CWL are programmed in the MR0 and MR2 registers, respectively. Prior to the first valid DQS edge, a full cycle is needed (including a dummy crossover of DQS, DQS#) and specified as the WRITE preamble shown. The half cycle on DQS following the last data-in element is known as the WRITE postamble. The time between the WRITE command and the first valid edge of DQS is WL clocks  $\pm tDQSS$ . through show the nominal case where  $tDQSS = 0ns$ ; however, includes  $tDQSS (MIN)$  and  $tDQSS (MAX)$  cases. Data may be masked from completing a WRITE using data mask. The data mask occurs on the DM ball aligned to the WRITE data. If DM is LOW, the WRITE completes normally. If DM is HIGH, that bit of data is masked. Upon completion of a burst, assuming no other commands have been initiated, the DQ will remain High-Z, and any additional input data will be ignored. Data for any WRITE burst may be concatenated with a subsequent WRITE command to provide a continuous flow of input data. The new WRITE command can be  $tCCD$  clocks following the previous WRITE command. The first data element from the new burst is applied after the last element of a completed burst.) show concatenated bursts. An example of nonconsecutive WRITES is shown. Data for any WRITE burst may be followed by a subsequent READ command after  $tWTR$  has been met. Data for any WRITE burst may be followed by a subsequent PRECHARGE command, providing  $tWR$  has been met, as show. Both  $tWTR$  and  $tWR$  starting time may vary, depending on the mode register settings (fixed BC4, BL8 versus OTF).



**$t_{WPRE}$  Timing**

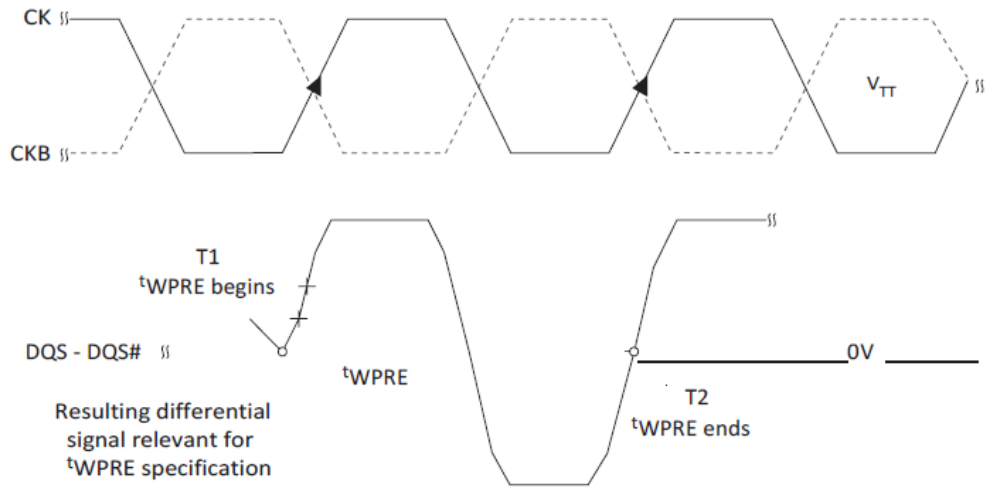

**$t_{WPST}$  Timing**

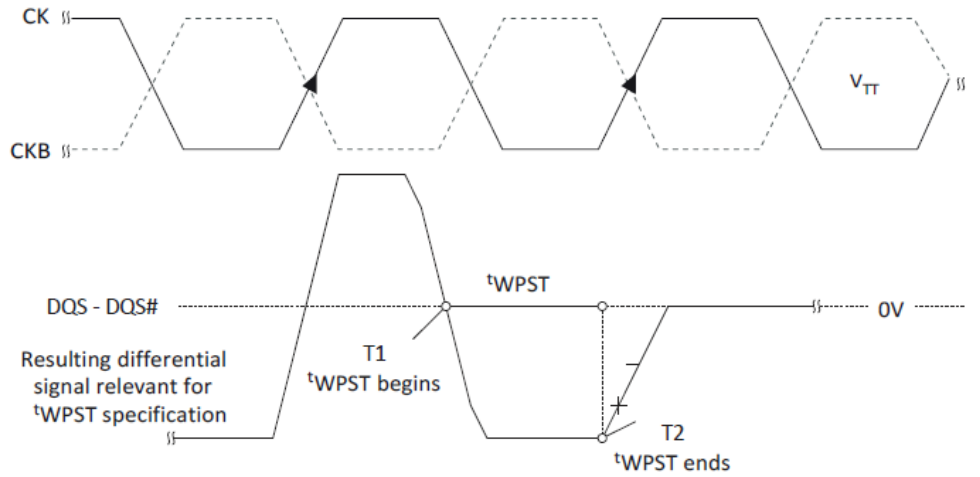



**WRITE Burst**

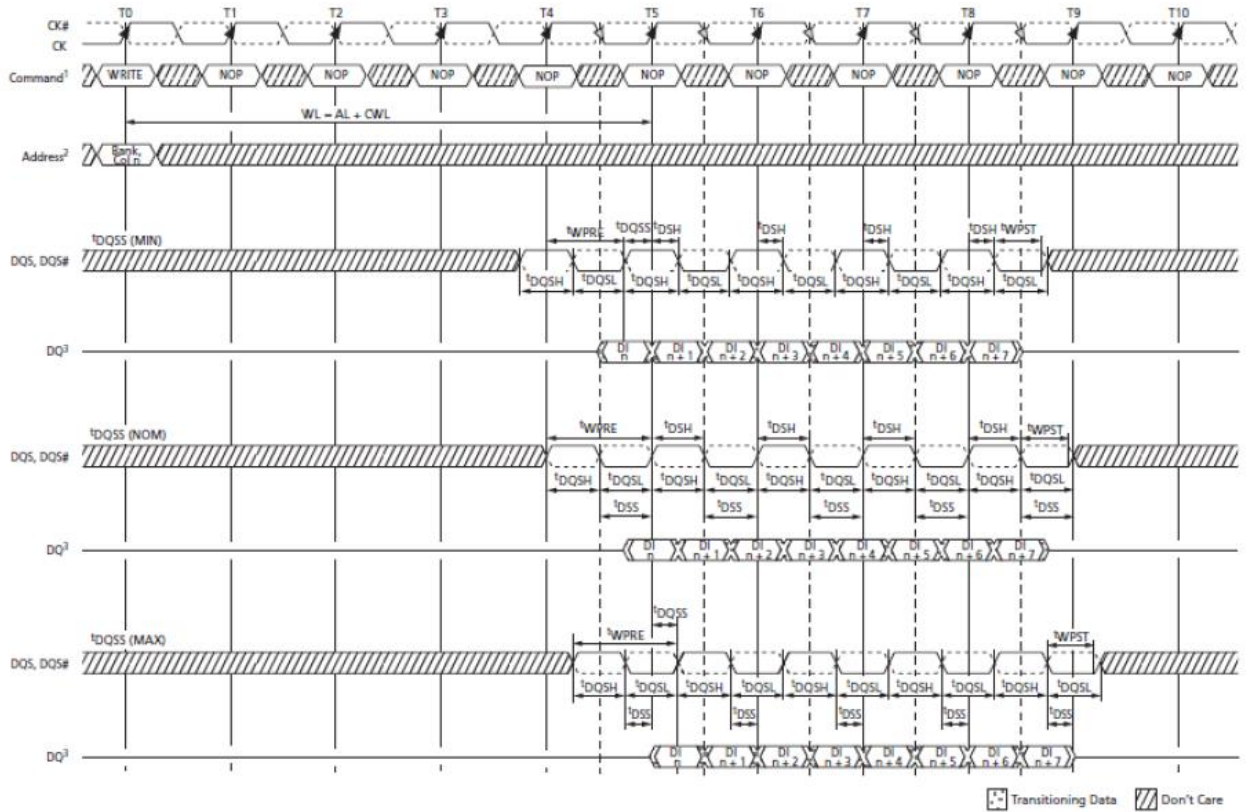

- Notes:
1. NOP commands are shown for ease of illustration; other commands may be valid at these times.
  2. The BL8 setting is activated by either MR0[1:0] = 00 or MR0[1:0] = 01 and A12 = 1 during the WRITE command at T0.
  3. DI  $n$  = data-in for column  $n$ .
  4. BL8, WL = 5 (AL = 0, CWL = 5).
  5.  $t_{DQSS}$  must be met at each rising clock edge.
  6.  $t_{WPST}$  is usually depicted as ending at the crossing of DQS, DQS#; however,  $t_{WPST}$  actually ends when DQS no longer drives LOW and DQS# no longer drives HIGH.



**Consecutive WRITE (BL8) to WRITE (BL8)**

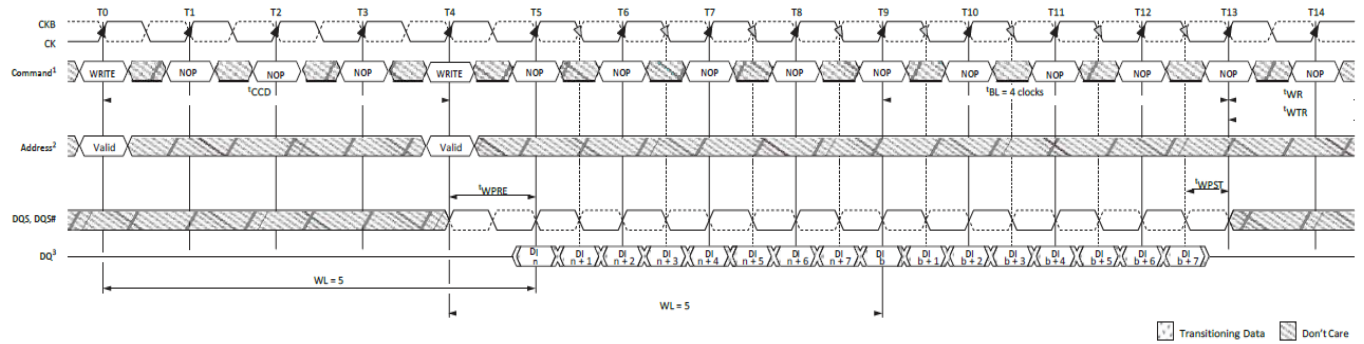

- Notes:
1. NOP commands are shown for ease of illustration; other commands may be valid at these times.
  2. The BL8 setting is activated by either MRO[1:0] = 00 or MRO[1:0] = 01 and A12 = 1 during the WRITE commands at T0 and T4.
  3. DI *n* (or *b*) = data-in for column *n* (or column *b*).
  4. BL8, WL = 5 (AL = 0, CWL = 5).

**Consecutive WRITE (BC4) to WRITE (BC4) via OTF**

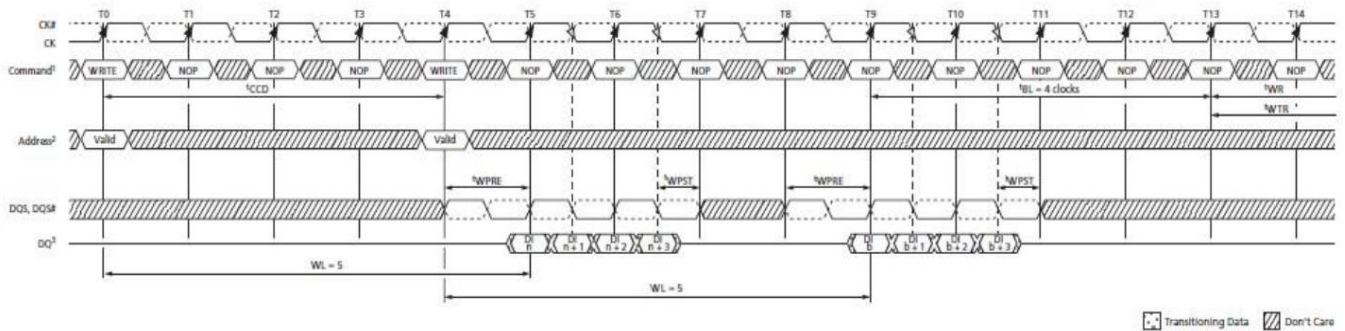

- Notes:
1. NOP commands are shown for ease of illustration; other commands may be valid at these times.
  2. BC4, WL = 5 (AL = 0, CWL = 5).
  3. DI *n* (or *b*) = data-in for column *n* (or column *b*).
  4. The BC4 setting is activated by MRO[1:0] = 01 and A12 = 0 during the WRITE command at T0 and T4.
  5. If set via MRS (fixed) tWR and tWTR would start T11 (2 cycles earlier).



**Nonconsecutive WRITE to WRITE**

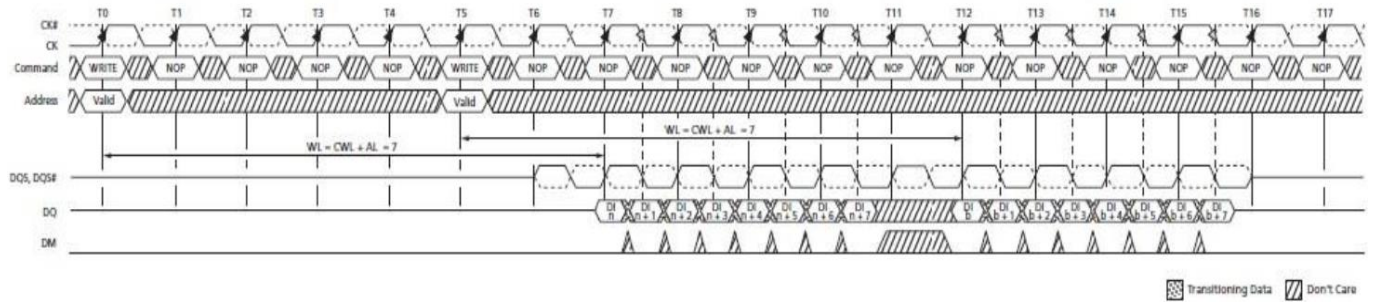

- Notes:
1. DI  $n$  (or  $b$ ) = data-in for column  $n$  (or column  $b$ ).
  2. Seven subsequent elements of data-in are applied in the programmed order following DO  $n$ .
  3. Each WRITE command may be to any bank.
  4. Shown for WL = 7 (CWL = 7, AL = 0).

**WRITE (BL8) to READ (BL8)**

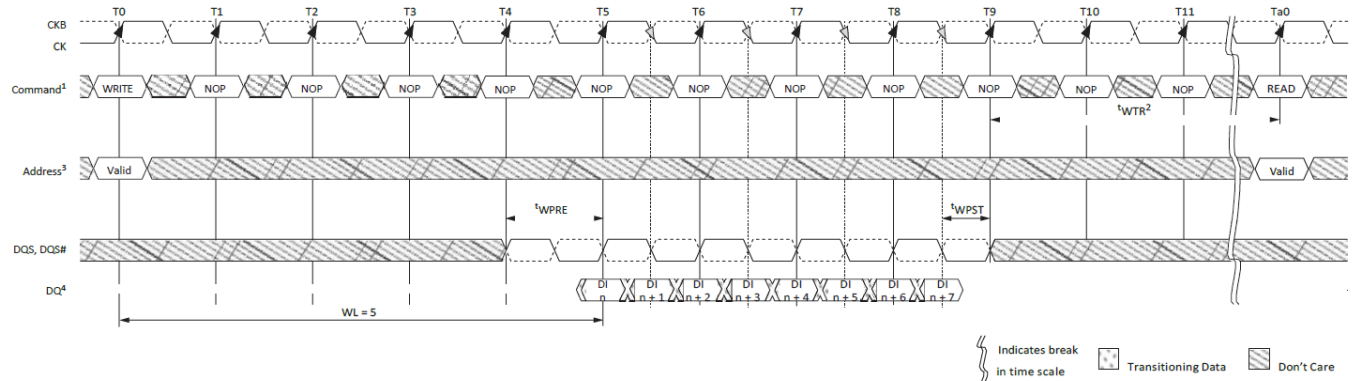

- Notes:
1. NOP commands are shown for ease of illustration; other commands may be valid at these times.
  2.  $t^1_{WTR}$  controls the WRITE-to-READ delay to the same device and starts with the first rising clock edge after the last write data shown at T9.
  3. The BL8 setting is activated by either MRO[1:0] = 00 or MRO[1:0] = 01 and MRO[12] = 1 during the WRITE command at T0. The READ command at Ta0 can be either BC4 or BL8, depending on MRO[1:0] and the A12 status at Ta0.
  4. DI  $n$  = data-in for column  $n$ .
  5. RL = 5 (AL = 0, CL = 5), WL = 5 (AL = 0, CWL = 5).



**WRITE to READ (BC4 Mode Register Setting)**

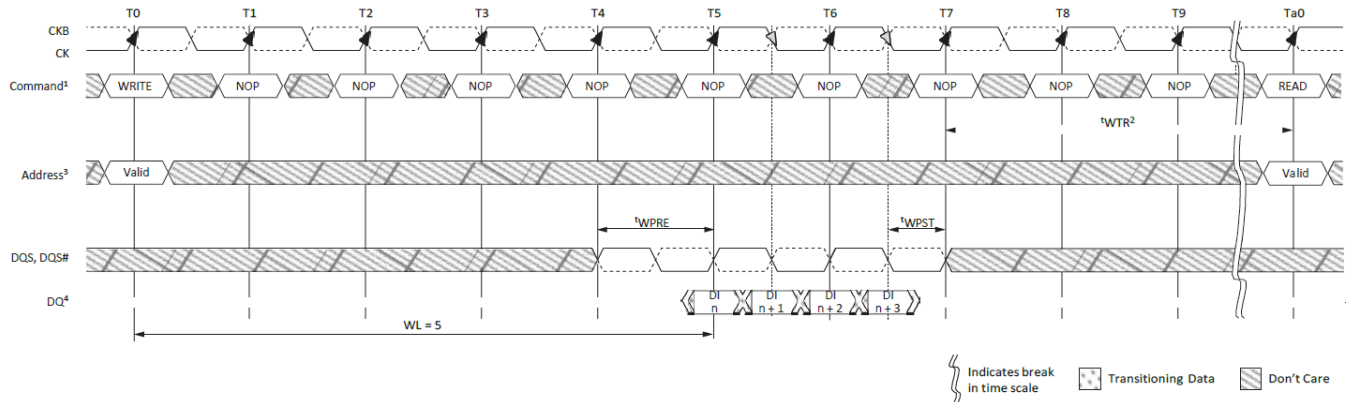

- Notes:
1. NOP commands are shown for ease of illustration; other commands may be valid at these times.
  2.  $t^1WTR$  controls the WRITE-to-READ delay to the same device and starts with the first rising clock edge after the last write data shown at T7.
  3. The fixed BC4 setting is activated by  $MRO[1:0] = 10$  during the WRITE command at T0 and the READ command at Ta0.
  4.  $DI_n$  = data-in for column  $n$ .
  5. BC4 (fixed),  $WL = 5$  ( $AL = 0, CWL = 5$ ),  $RL = 5$  ( $AL = 0, CL = 5$ ).

**WRITE (BC4 OTF) to READ (BC4 OTF)**

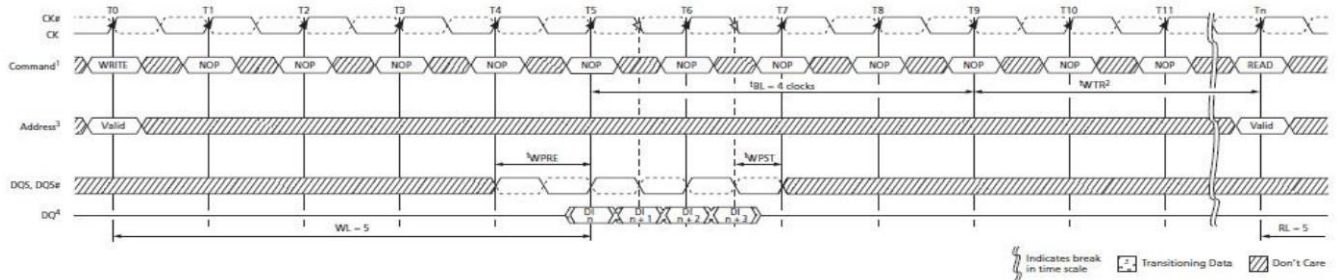

- Notes:
1. NOP commands are shown for ease of illustration; other commands may be valid at these times.
  2.  $t^1WTR$  controls the WRITE-to-READ delay to the same device and starts after  $t^1BL$ .
  3. The BC4 OTF setting is activated by  $MRO[1:0] = 01$  and  $A12 = 0$  during the WRITE command at T0 and the READ command at Tn.
  4.  $DI_n$  = data-in for column  $n$ .
  5. BC4,  $RL = 5$  ( $AL = 0, CL = 5$ ),  $WL = 5$  ( $AL = 0, CWL = 5$ ).



**WRITE (BL8) to PRECHARGE**

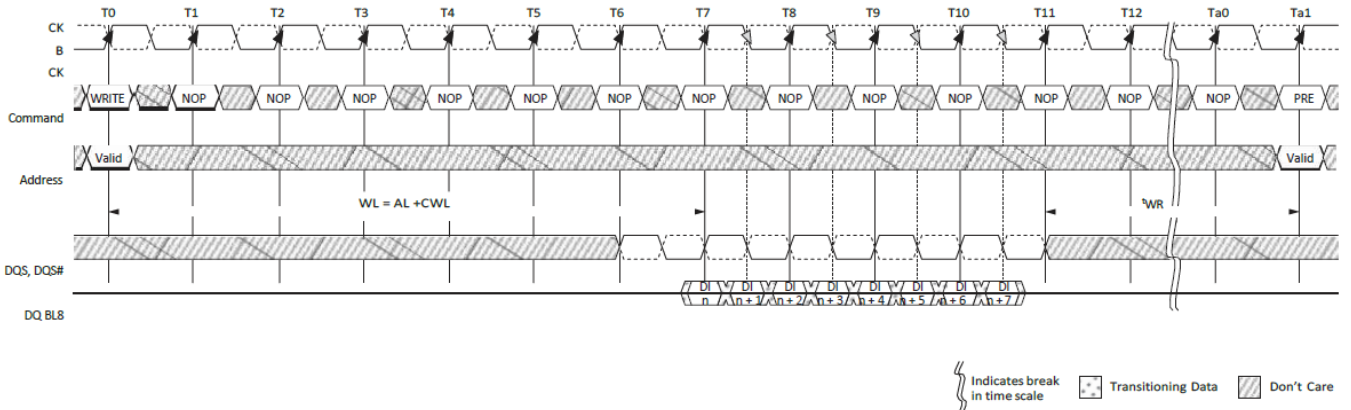

- Notes:
1. DI  $n$  = data-in from column  $n$ .
  2. Seven subsequent elements of data-in are applied in the programmed order following DO  $n$ .
  3. Shown for WL = 7 (AL = 0, CWL = 7).

**WRITE (BC4 Mode Register Setting) to PRECHARGE**

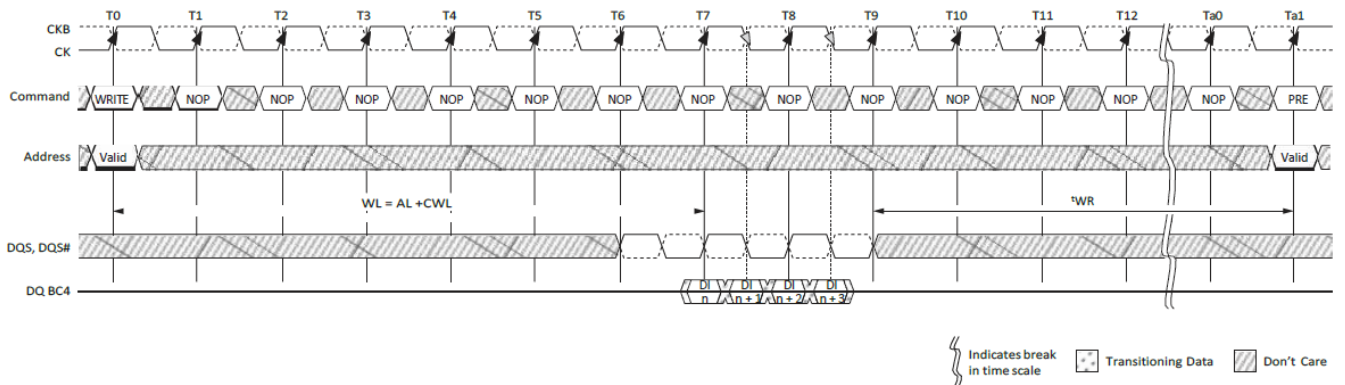

- Notes:
1. NOP commands are shown for ease of illustration; other commands may be valid at thesetimes.
  2. The write recovery time ( $t_{WR}$ ) is referenced from the first rising clock edge after the last write data is shown at T7.  $t_{WR}$  specifies the last burst WRITE cycle until the PRECHARGE command can be issued to the samebank.
  3. The fixed BC4 setting is activated by MRO[1:0] = 10 during the WRITE command at T0.
  4. DI  $n$  = data-in for column  $n$ .
  5. BC4 (fixed), WL = 5, RL = 5.



**WRITE (BC4 OTF) to PRECHARGE**

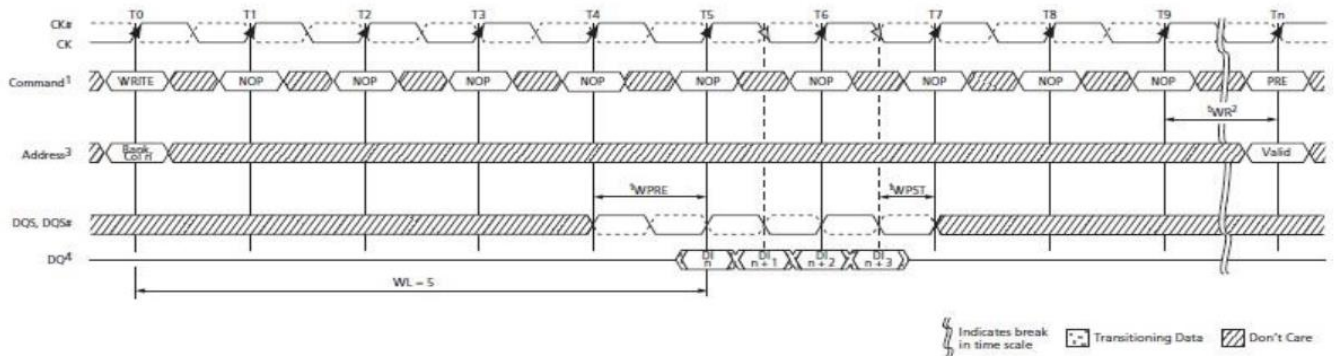

- Notes:
- 1 NOP commands are shown for ease of illustration; other commands may be valid at these times.
  - 2 The write recovery time ( $t_{WR}$ ) is referenced from the rising clock edge at T9.  $t_{WR}$  specifies the last burst WRITE cycle until the PRECHARGE command can be issued to the same bank.
  - 3 The BC4 setting is activated by  $MR0[1:0] = 01$  and  $A12 = 0$  during the WRITE command at T0.
  - 4  $DI_n =$  data-in for column  $n$ .
  - 5 BC4 (OTF),  $WL = 5$ ,  $RL = 5$ .

**DQ Input Timing**

Shows the strobe-to-clock timing during a WRITE burst. DQS, DQS# must transition within  $0.25t_{CK}$  of the clock transitions, as limited by  $t_{DQSS}$ . All data and data mask setup and hold timings are measured relative to the DQS, DQS# crossing, not the clock crossing. The WRITE preamble and postamble are also shown. One clock prior to data input to the DRAM, DQS must be HIGH and DQS# must be LOW. Then for a half clock, DQS is driven LOW (DQS# is driven HIGH) during the WRITE preamble,  $t_{WPRE}$ . Likewise, DQS must be kept LOW by the controller after the last data is written to the DRAM during the WRITE postamble,  $t_{WPST}$ . Data setup and hold times are also shown. All setup and hold times are measured from the crossing points of DQS and DQS#. These setup and hold values pertain to data input and data mask input. Additionally, the half period of the data input strobe is specified by  $t_{DQSH}$  and  $t_{DQSL}$ .



## Data Input Timing

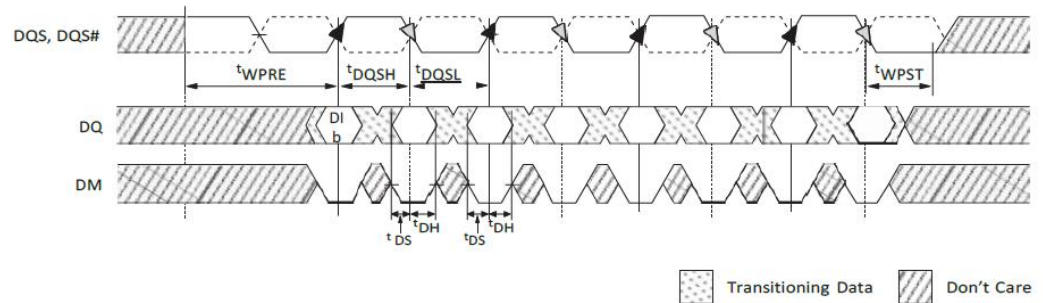

## 16.5 PRECHARGE Operation

Input A10 determines whether one bank or all banks are to be precharged and, in the case where only one bank is to be precharged, inputs BA[2:0] select the bank. When all banks are to be precharged, inputs BA[2:0] are treated as “Don’t Care.” After a bank is precharged, it is in the idle state and must be activated prior to any READ or WRITE commands being issued.

## 16.6 SELF REFRESH Operation

The SELF REFRESH operation is initiated like a REFRESH command except CKE is LOW.

The DLL is automatically disabled upon entering SELF REFRESH and is automatically enabled and reset upon exiting SELF REFRESH.

All power supply inputs (including VREFCA and VREFDQ) must be maintained at valid levels upon entry/exit and during self refresh mode operation. VREFDQ may float or not drive VDDQ/2 while in self refresh mode under certain conditions:

- VSS < VREFDQ < VDD is maintained.
- VREFDQ is valid and stable prior to CKE going back HIGH.
- The first WRITE operation may not occur earlier than 512 clocks after VREFDQ is valid.
- All other self refresh mode exit timing requirements are met.

The DRAM must be idle with all bank signals in the precharge state (t<sub>RP</sub> is satisfied and no bursts are in progress) before a self refresh entry command can be issued. ODT must also be turned off before self refresh entry by registering the ODT ball LOW prior to the self refresh entry command (see On-Die Termination (ODT) (for timing requirements)).

If RTT<sub>nom</sub> and RTT(WR) are disabled in the mode registers, ODT can be a “Don’t Care.” After the self refresh entry command is registered,



CKE must be held LOW to keep the DRAM in self refresh mode. After the DRAM has entered self refresh mode, all external control signals, except CKE and RESET#, are “Don’t Care.” The DRAM initiates a minimum of one REFRESH command internally within the tCKE period when it enters self refresh mode.

The requirements for entering and exiting self refresh mode depend on the state of the clock during self refresh mode. First and foremost, the clock must be stable (meeting tCK specifications) when self refresh mode is entered. If the clock remains stable and the frequency is not altered while in self refresh mode, then the DRAM is allowed to exit self refresh mode after tCKESR is satisfied (CKE is allowed to transition HIGH tCKESR later than when CKE was registered LOW). Since the clock remains stable in self refresh mode (no frequency change), tCKSRE and tCKSRX are not required. However, if the clock is altered during self refresh mode (if it is turned-off or its frequency changes), then tCKSRE and tCKSRX must be satisfied. When entering self refresh mode, tCKSRE must be satisfied prior to altering the clock's frequency. Prior to exiting self refresh mode, tCKSRX must be satisfied prior to registering CKE HIGH. When CKE is HIGH during self refresh exit, NOP or DES must be issued for tXS time. tXS is required for the completion of any internal refresh already in progress and must be satisfied before a valid command not requiring a locked DLL can be issued to the de-vice. tXS is also the earliest time self refresh re-entry may occur. Before a command requiring a locked DLL can be applied, a ZQCL command must be issued, tZQOPER timing must be met, and tXSDDL must be satisfied. ODT must be off during tXSDDL.





### Self Refresh Entry/Exit Timing

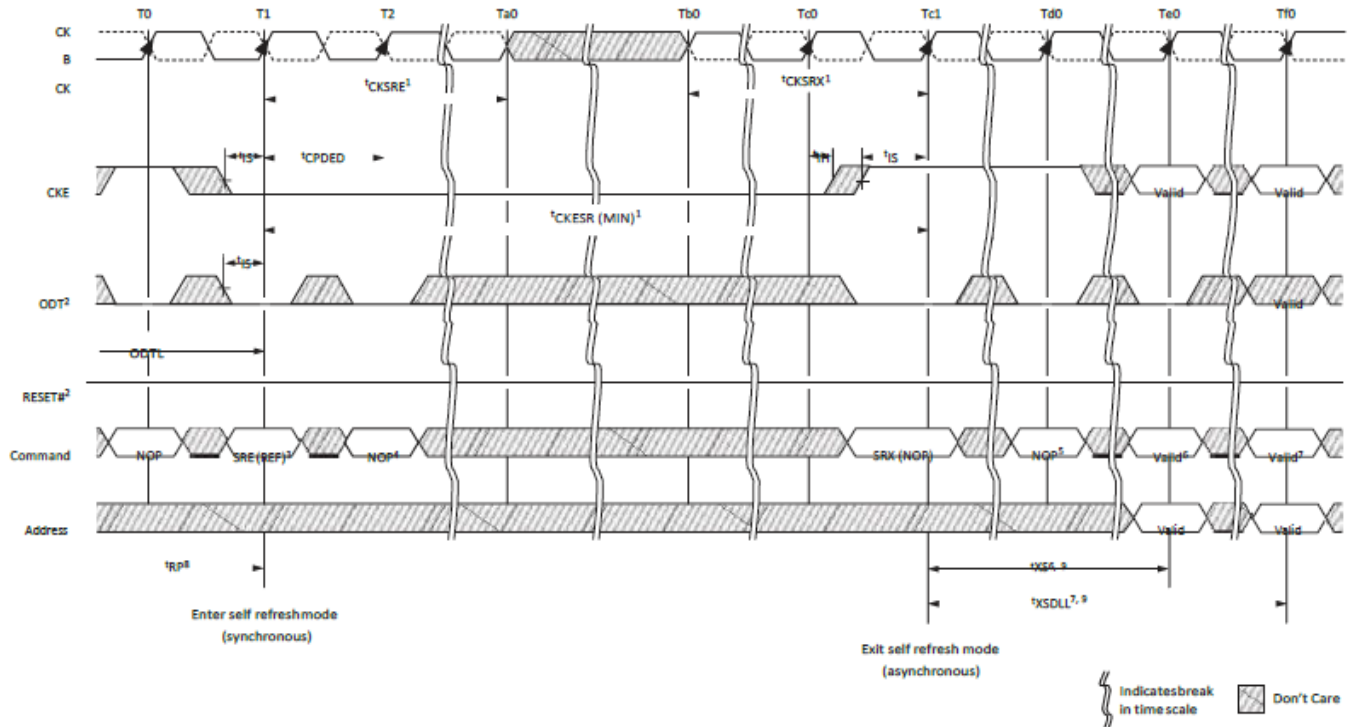

- Notes:
- 1 The clock must be valid and stable, meeting tCK specifications at least tCKSRE after entering self refresh mode, and at least tCKSRX prior to exiting self refresh mode, if the clock is stopped or altered between states Ta0 and Tb0. If the clock remains valid and unchanged from entry and during self refresh mode, then tCKSRE and tCKSRX do not apply; however, tCKESR must be satisfied prior to exiting at SRX.
  - 2 ODT must be disabled and RTT off prior to entering self refresh at state T1. If both RTT,nom and RTT(WR) are disabled in the mode registers, ODT can be a “Don’t Care.”
  - 3 Self refresh entry (SRE) is synchronous via a REFRESH command with CKE LOW.
  - 4 A NOP or DES command is required at T2 after the SRE command is issued prior to the inputs becoming “Don’t Care.”
  - 5 NOP or DES commands are required prior to exiting self refresh mode until state Te0.
  - 6 tXS is required before any commands not requiring a locked DLL.
  - 7 tXDDL is required before any commands requiring a locked DLL.
  - 8 The device must be in the all banks idle state prior to entering self refresh mode. For example, all banks must be precharged, tRP must be met, and no data bursts can be in progress.
  - 9 Self refresh exit is asynchronous; however, tXS and tXDDL timings start at the first rising clock edge where CKE HIGH satisfies tISXR at Tc1. tCKSRX timing is also measured so that tISXR is satisfied at Tc1.

## 16.7 Extended Temperature Usage

PTC’s DDR3 SDRAM support the optional extended case



temperature (TC) range of 0°C to 95°C. Thus, the SRT and ASR options must be used at a minimum.

The extended temperature range DRAM must be refreshed externally at 2x (double refresh) anytime the case temperature is above 85°C (and does not exceed 95°C). The external refresh requirement is accomplished by reducing the refresh period from 64ms to 32ms. However, self refresh mode requires either ASR or SRT to support the extended temperature. Thus, either ASR or SRT must be enabled when TC is above 85°C or self refresh can not be used until TC is at or below 85°C. summarizes the two extended temperature options and summarizes how the two extended temperature options relate to one another.

#### Self Refresh Temperature and Auto Self Refresh Description

Field	MR2 Bits	Description
<b>Self Refresh Temperature (SRT)</b>		
SRT	7	If ASR is disabled (MR2[6] = 0), SRT must be programmed to indicate T <sub>OPER</sub> during self refresh: *MR2[7] = 0: Normal operating temperature range (0°C to 85°C) *MR2[7] = 1: Extended operating temperature range (0°C to 95°C) If ASR is enabled (MR2[7] = 1), SRT must be set to 0, even if the extended temperature range is supported *MR2[7] = 0: SRT is disabled
<b>Auto Self Refresh (ASR)</b>		
ASR	6	When ASR is enabled, the DRAM automatically provides SELF REFRESH power management functions, (refresh rate for all supported operating temperature values) * MR2[6] = 1: ASR is enabled (M7 must = 0) When ASR is not enabled, the SRT bit must be programmed to indicate T <sub>OPER</sub> during SELF REFRESH operation * MR2[6] = 0: ASR is disabled; must use manual self refresh temperature (SRT)

#### Self Refresh Mode Summary

MR2[6] (ASR)	MR2[7] (SRT)	SELF REFRESH Operation	Permitted Operating Temperature Range for Self Refresh Mode
0	0	Self refresh mode is supported in the normal temperature range	Normal (0°C to 85°C)
0	1	Self refresh mode is supported in normal and extended temperature ranges; When SRT is enabled, it increases self refresh power consumption	Normal and extended (0°C to 95°C)
1	0	Self refresh mode is supported in normal and extended temperature ranges; Self refresh power consumption may be temperature-dependent	Normal and extended (0°C to 95°C)
1	1	Illegal	



## 16.8 Power-Down Mode

Power-down is synchronously entered when CKE is registered LOW coincident with a NOP or DES command. CKE is not allowed to go LOW while an MRS, MPR, ZQCAL, READ, or WRITE operation is in progress. CKE is allowed to go LOW while any of the other legal operations (such as ROW ACTIVATION, PRECHARGE, auto precharge, or REFRESH) are in progress. However, the power-down IDD specifications are not applicable until such operations have completed. Depending on the previous DRAM state and the command issued prior to CKE going LOW, certain timing constraints must be satisfied. Timing diagrams detailing the different power-down mode entry and exits are shown.

**Command to Power-Down Entry Parameters**

DRAM Status	Last Command Prior to CKE LOW <sup>1</sup>	Parameter (Min)	Parameter Value
Idle or active	ACTIVATE	<sup>t</sup> ACTPDEN	1 <sup>t</sup> CK
Idle or active	PRECHARGE	<sup>t</sup> PRPDEN	1 <sup>t</sup> CK
Active	READ or READAP	<sup>t</sup> RDPDEN	RL + 4 <sup>t</sup> CK + 1 <sup>t</sup> CK
Active	WRITE: BL8OTF, BL8MRS, BC4OTF	<sup>t</sup> WRPDEN	WL + 4 <sup>t</sup> CK + <sup>t</sup> WR/ <sup>t</sup> CK
Active	WRITE: BC4MRS		WL + 2 <sup>t</sup> CK + <sup>t</sup> WR/ <sup>t</sup> CK
Active	WRITEAP: BL8OTF, BL8MRS, BC4OTF	<sup>t</sup> WRAPDEN	WL + 4 <sup>t</sup> CK + WR + 1 <sup>t</sup> CK
Active	WRITEAP: BC4MRS		WL + 2 <sup>t</sup> CK + WR + 1 <sup>t</sup> CK
Idle	REFRESH	<sup>t</sup> REFPDEN	1 <sup>t</sup> CK
Power-down	REFRESH	<sup>t</sup> XPDLL	Greater of 10 <sup>t</sup> CK or 24ns
Idle	MODE REGISTER SET	<sup>t</sup> MRSPDEN	<sup>t</sup> MOD

Note: 1 If slow-exit mode precharge power-down is enabled and entered, ODT becomes asynchronous tANPD prior to CKE going LOW and remains asynchronous until tANPD + tXPDLL after CKE goes HIGH.

Entering power-down disables the input and output buffers, excluding CK, CKB, ODT, CKE, and RESET#. NOP or DES commands are required until tCPDED has been satisfied, at which time all specified input/output buffers are disabled. The DLL should be in a locked state when power-down is entered for the fastest power-down exit timing. If the DLL is not locked during power-down entry, the DLL must be reset after exiting power-down mode for proper READ operation as well as synchronous ODT operation. During power-down entry, if any bank remains open after all in-progress commands are complete, the DRAM will be inactive power-down mode. If



all banks are closed after all in-progress commands are complete, the DRAM will be in precharge power down mode. Precharge power-down mode must be programmed to exit with either a slow exit mode or a fast exit mode. When entering precharge power-down mode, the DLL is turned off in slow exit mode or kept on in fast exit mode. The DLL also remains on when entering active power-down. ODT has special timing constraints when slow exit mode precharge power-down is enabled and entered. Refer to Asynchronous ODT Mode for detailed ODT usage requirements in slow Exit mode precharge power-down. A summary of the two power-down modes is listed. While in either power-down state, CKE is held LOW, RESET# is held HIGH, and a stable clock signal must be maintained. ODT must be in a valid state but all other input signals are “Don’t Care.” If RESET# goes LOW during power-down, the DRAM will switch out of power-down mode and go into the reset state. After CKE is registered LOW, CKE must remain LOW until tPD (MIN) has been satisfied. The maximum time allowed for power-down duration is tPD(MAX) (9 × tREFI). The power-down states are synchronously exited when CKE is registered HIGH (with a required NOP or DES command). CKE must be maintained HIGH until tCKE has been satisfied. A valid, executable command may be applied after power-down exit latency, tXP, and tXPDLL have been satisfied. A summary of the power-down modes is listed below. For specific CKE-intensive operations, such as repeating a power-down-exit-to-refresh to- power-down-entry sequence, the number of clock cycles between power-down exit and power-down entry may not be sufficient to keep the DLL properly updated. In addition to meeting tPD when the REFRESH command is used between power-down exit and power-down entry, two other conditions must be met. First, tXP must be satisfied before issuing the REFRESH command. Second, tXPDLL must be satisfied before the next power-down may be entered. An example is shown.

**Power-Down Modes**

DRAM State	MR0[12]	DLL State	Power-Down Exit	Relevant Parameters
Active (any bank open)	“Don’t Care”	On	Fast	tXP to any other valid command
Precharged (all banks precharged)	1	On	Fast	tXP to any other valid command
	0	Off	Slow	tXPDLL to commands that require the DLL to be locked (READ, RDAP, or ODT on); tXP to any other valid command



**Active Power-Down Entry and Exit**

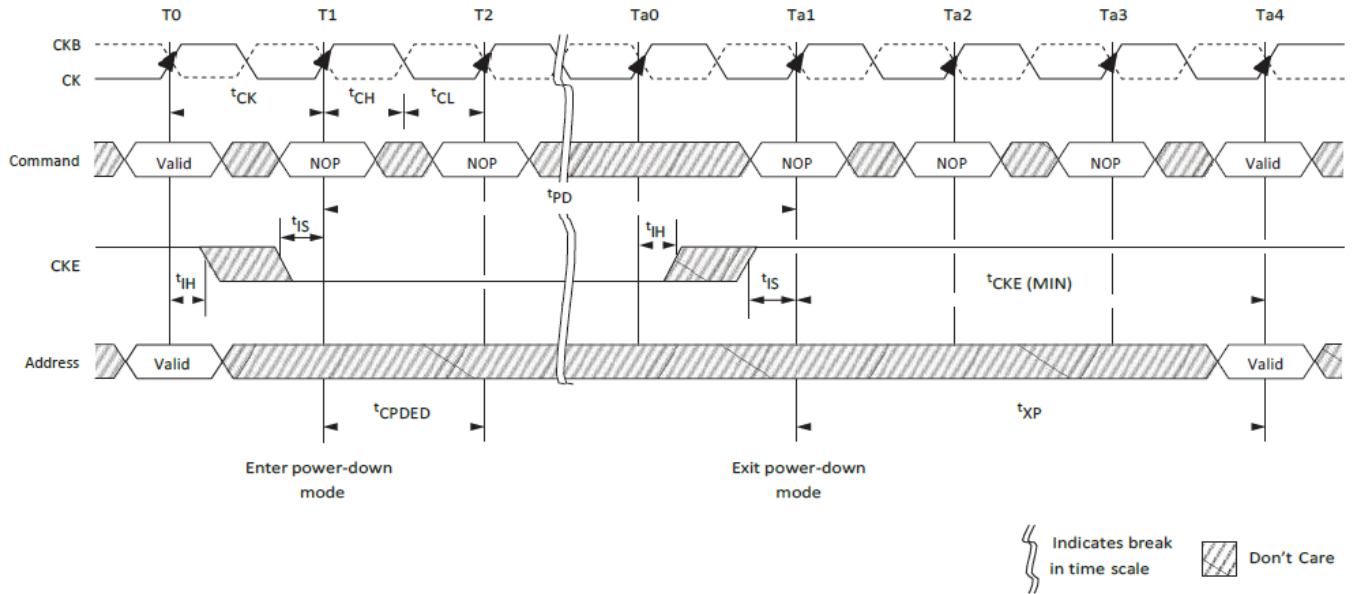

**Precharge Power-Down (Fast-Exit Mode) Entry and Exit**

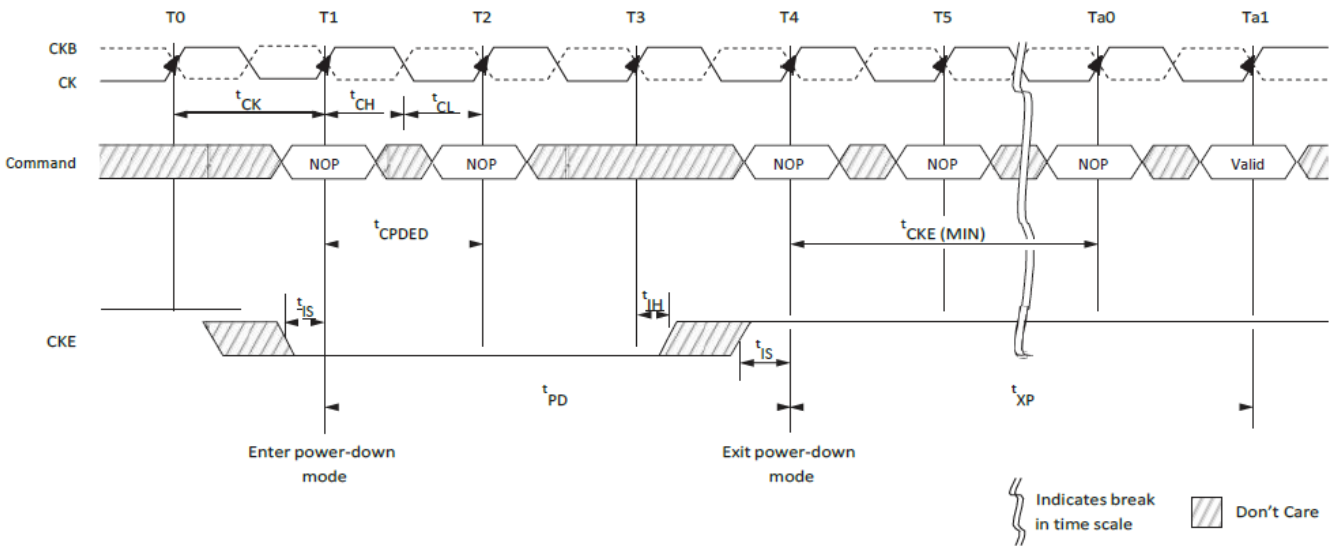

### Precharge Power-Down (Slow-Exit Mode) Entry and Exit

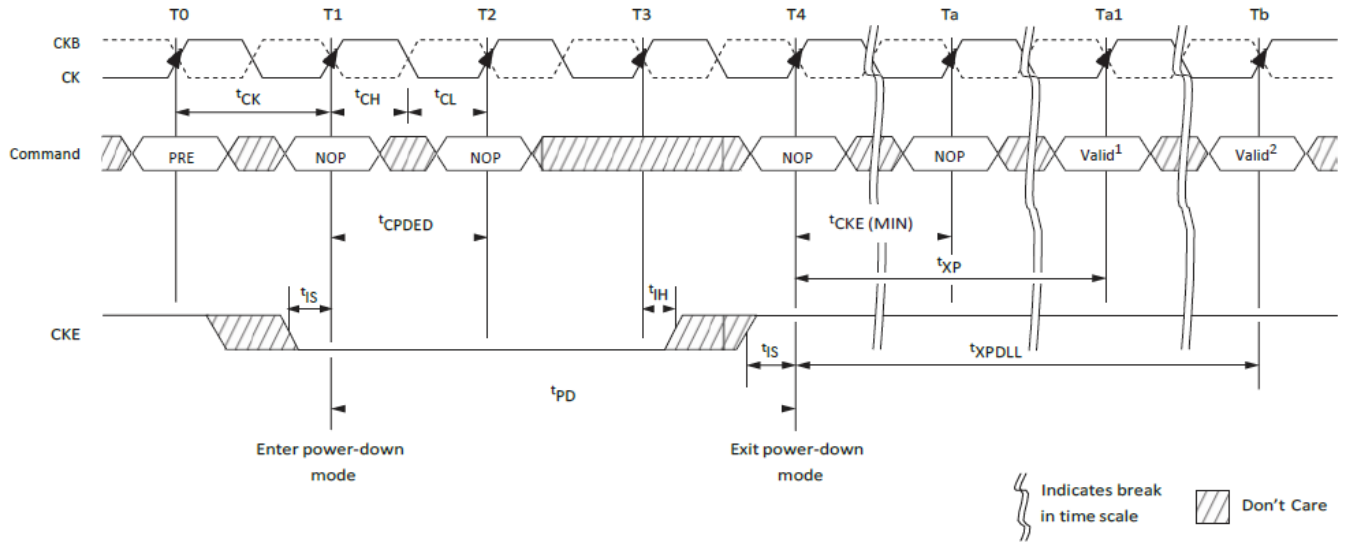

- Notes: 1. Any valid command not requiring a locked DLL.  
2. Any valid command requiring a locked DLL.

### Power-Down Entry After READ or READ with Auto Precharge (RDAP)

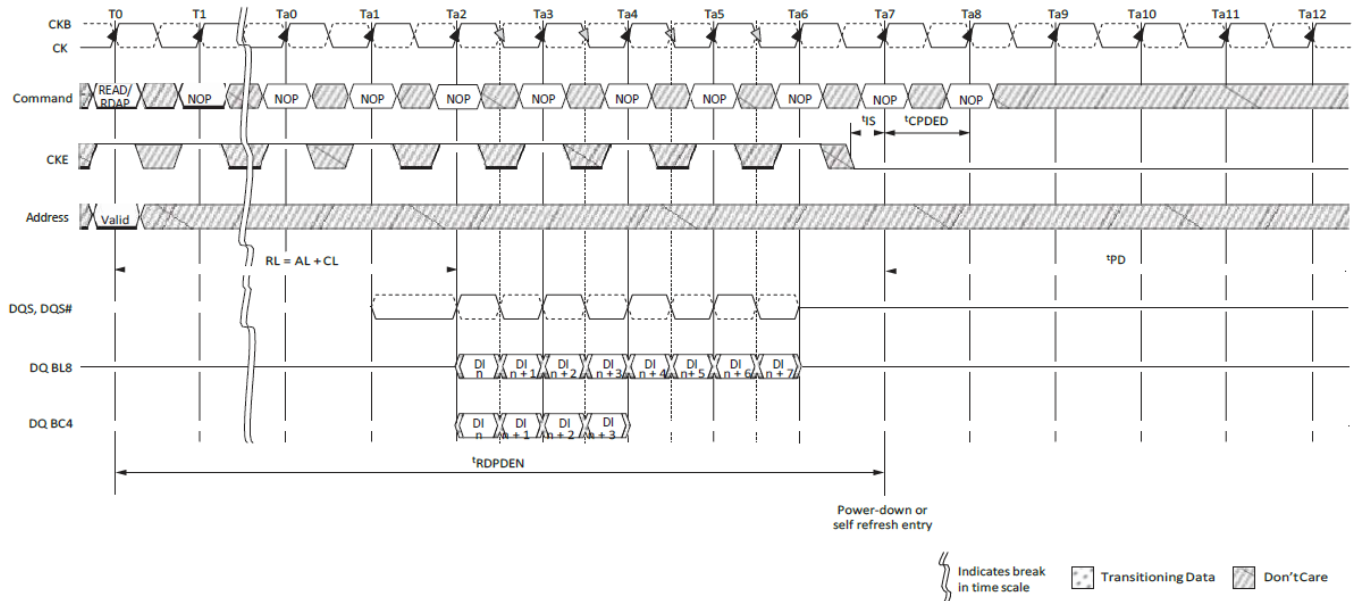

**Power-Down Entry After WRITE**

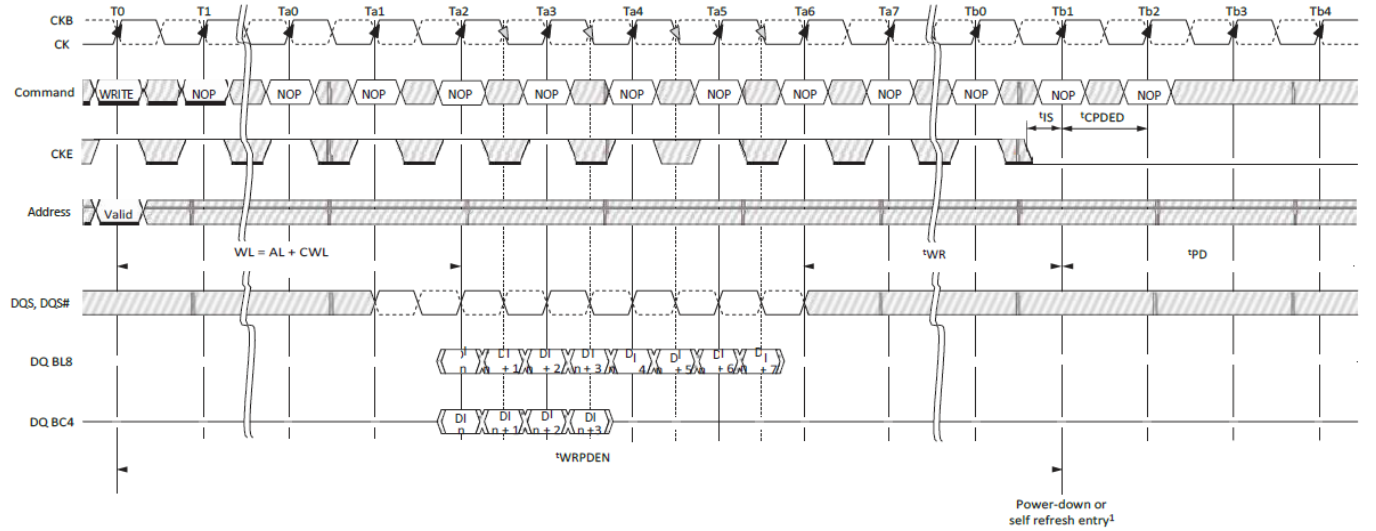

Indicates break in time scale  
 Transitioning Data  
 Don't Care

Note: 1. CKE can go LOW  $2^tCK$  earlier if BC4MRS.

CONFIDENTIAL



### Power-Down Entry After WRITE with Auto Precharge (WRAP)

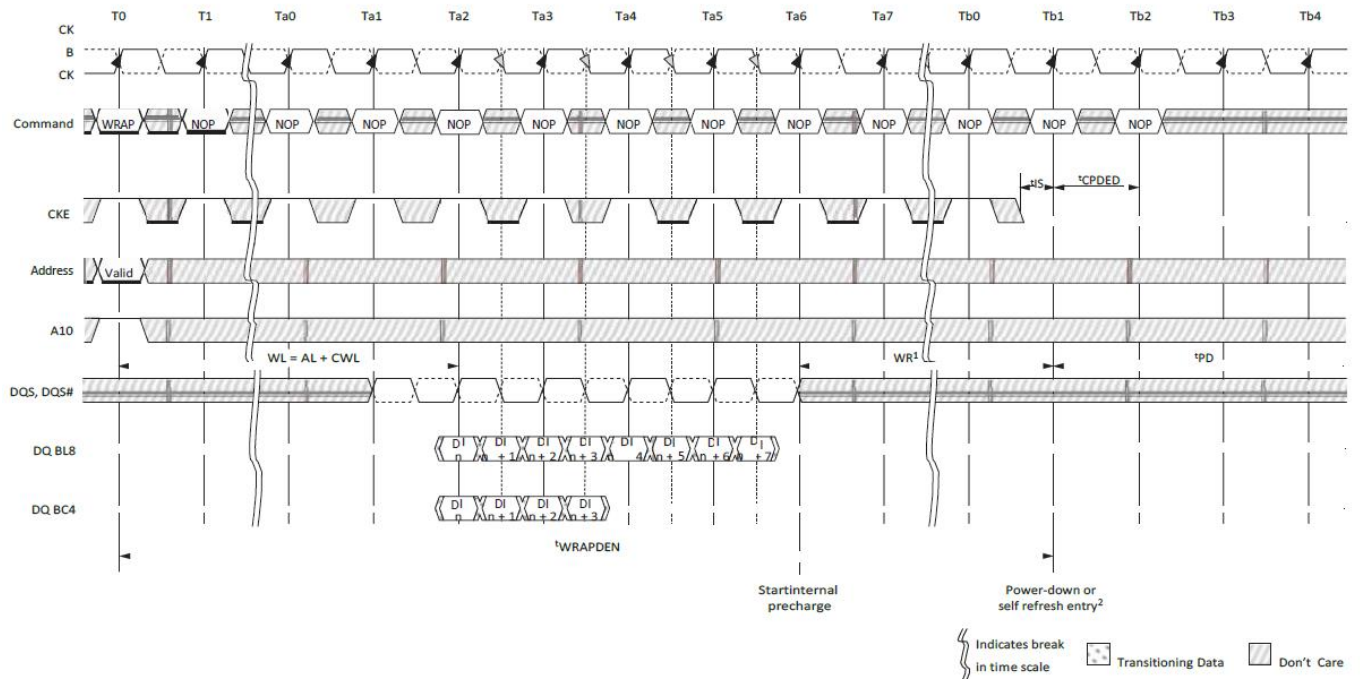

### REFRESH to Power-Down Entry

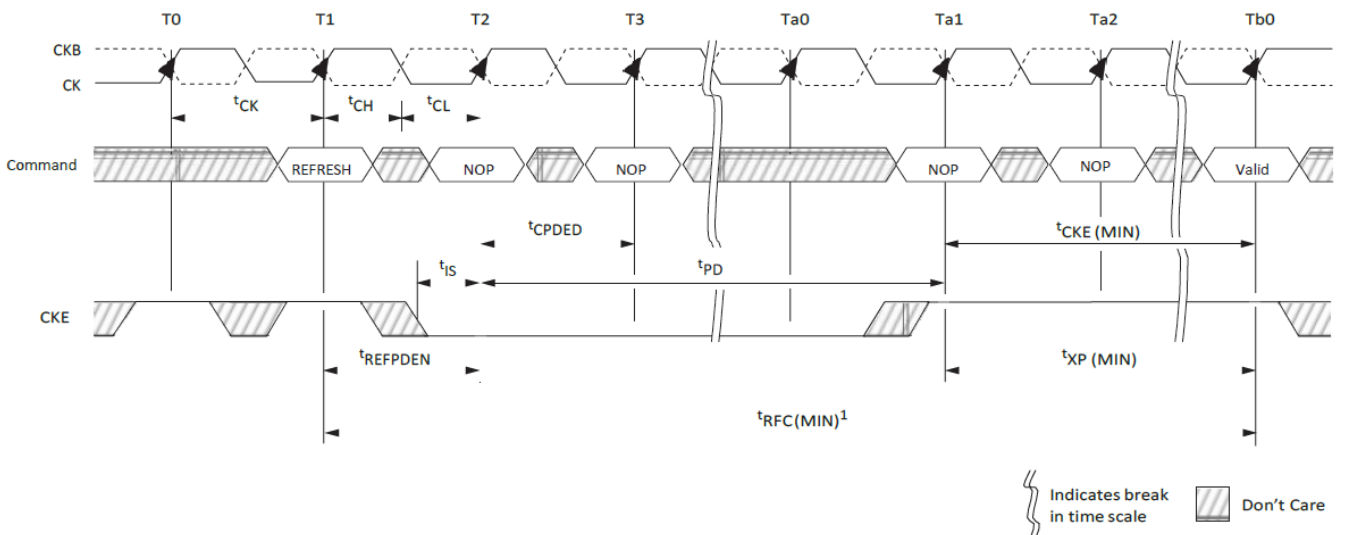



**ACTIVATE to Power-Down Entry**

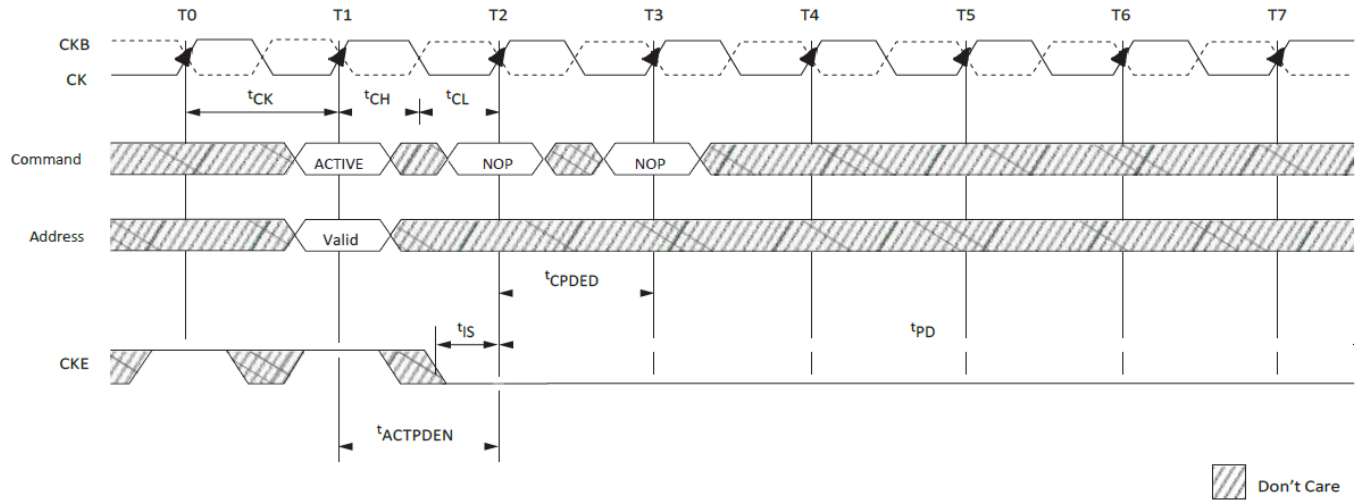

**PRECHARGE to Power-Down Entry**

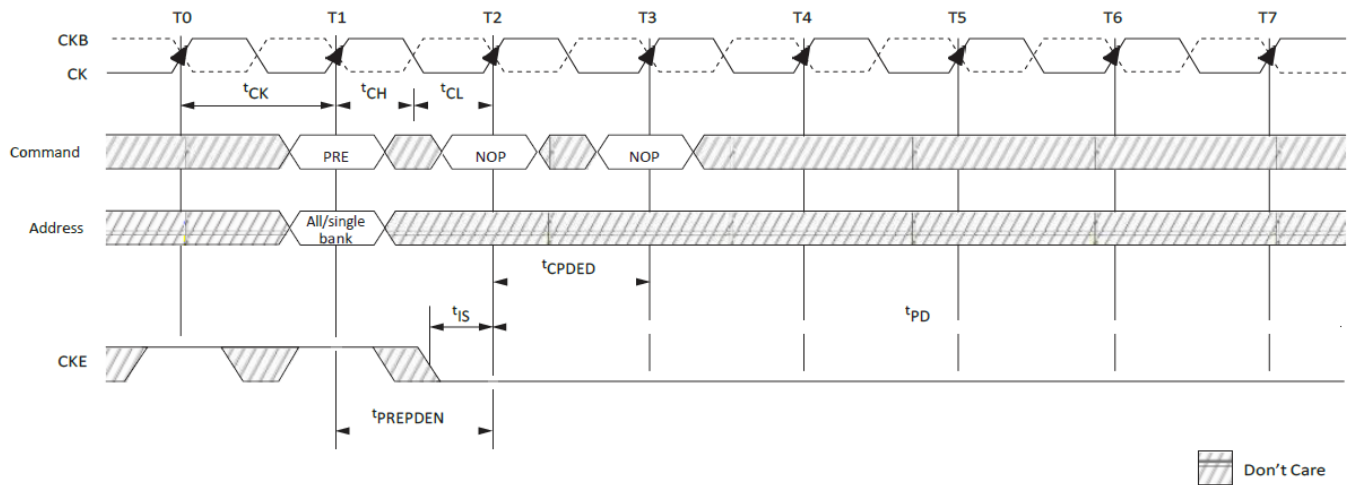

**MRS Command to Power-Down Entry**

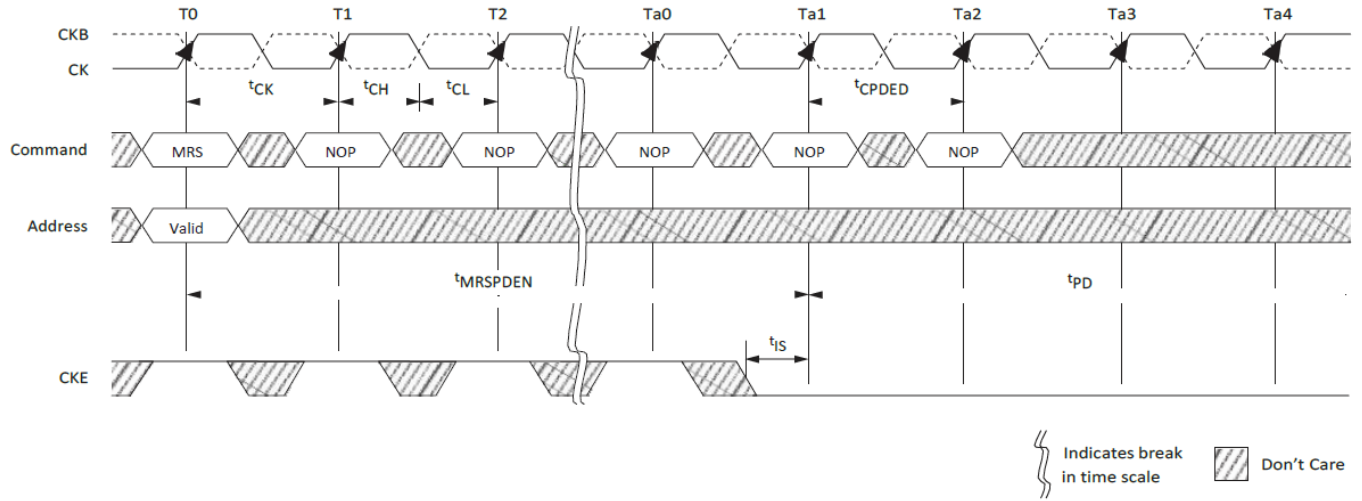

CONFIDENTIAL



**Power-Down Exit to Refresh to Power-Down Entry**

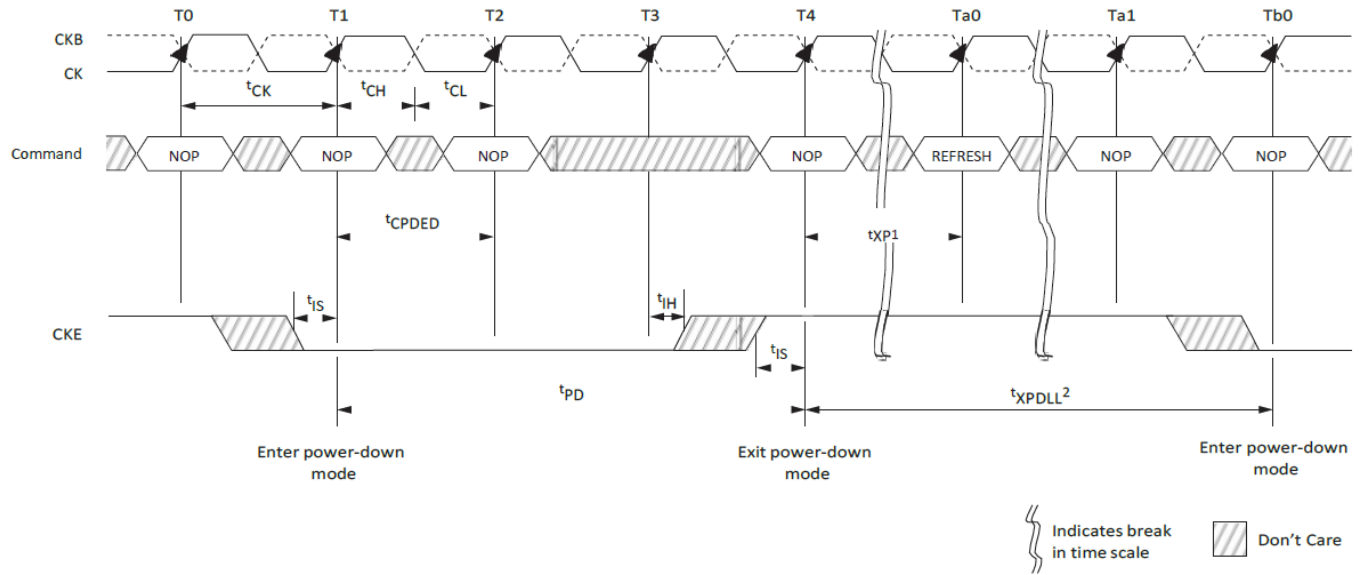

- Notes:
1.  $t_{XP}$  must be satisfied before issuing the command.
  2.  $t_{XPDLL}$  must be satisfied (referenced to the registration of power-down exit) before the next power-down can be entered.

CONFIDENTIAL



## 16.9 RESET Operation

The RESET signal (RESET#) is an asynchronous reset signal that triggers any time it drops LOW, and there are no restrictions about when it can go LOW. After RESET# goes LOW, it must remain LOW for 100ns. During this time, the outputs are disabled, ODT (RTT) turns off (High-Z), and the DRAM resets itself. CKE should be driven LOW prior to RESET# being driven HIGH. After RESET# goes HIGH, the DRAM must be re-initialized as though a normal power-up was executed. All counters, except refresh counters, on the DRAM are reset, and data stored in the DRAM is assumed unknown after RESET# has gone LOW.



### RESET Sequence

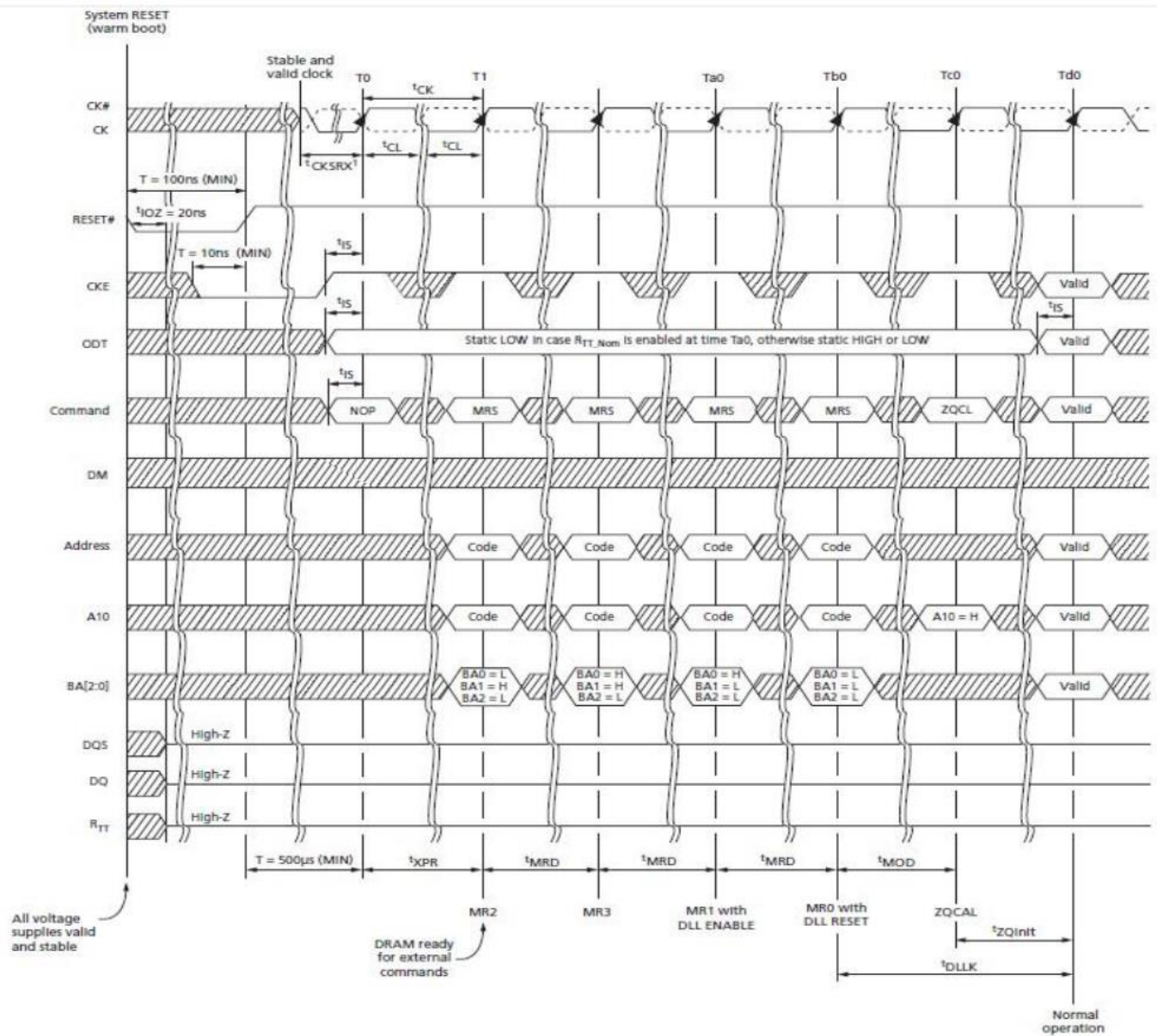

Note: 1. The minimum time required is the longer of 10ns or 5 clocks.



## 17. On-Die Termination (ODT)

On-die termination (ODT) is a feature that enables the DRAM to enable/disable and turn on/off termination resistance for each DQ, DQS, DQS#, and DM for the x4 and x8 configurations (# for the x8 configuration, when enabled). ODT is applied to each DQ, UDQS, UDQS#, LDQS, LDQS#, UDM, and DML signal for the x16 configuration.

ODT is designed to improve signal integrity of the memory channel by enabling the DRAM controller to independently turn on/off the DRAM's internal termination resistance for any grouping of DRAM devices. ODT is not supported during DLL disable mode (simple functional representation shown below). The switch is enabled by the internal ODT control logic, which uses the external ODT ball and other control information.

### On-Die Termination

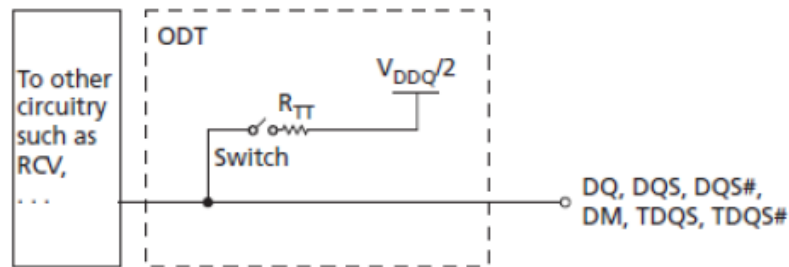

### Functional Representation of ODT

The value of  $R_{TT}$  (ODT termination resistance value) is determined by the settings of several mode register bits. The ODT ball is ignored while in self refresh mode (must be turned off prior to self refresh entry) or if mode registers MR1 and MR2 are programmed to disable ODT. ODT is comprised of nominal ODT and dynamic ODT modes and either of these can function in synchronous or asynchronous mode (when the DLL is off during precharge power-down or when the DLL is synchronizing). Nominal ODT is the base termination and is used in any allowable ODT state. Dynamic ODT is applied only during writes and provides OTF switching from no  $R_{TT}$  or  $R_{TT,nom}$  to  $R_{TT}(WR)$ . The actual effective termination,  $R_{TT}(EFF)$ , may be different from  $R_{TT}$  targeted due to nonlinearity of the termination. For  $R_{TT}(EFF)$  values and calculations.

### Nominal ODT

ODT (NOM) is the base termination resistance for each applicable



ball; it is enabled or disabled via MR1[9,6,2] (see Mode Register1(MR1) Definition), and it is turned on or off via the ODT ball.

**Truth Table – ODT (Nominal)**

Note 1 applies to the entire table

MR1[9, 6, 2]	ODT Pin	DRAM Termination State	DRAM State	Notes
000	0	$R_{TT,nom}$ disabled, ODT off	Any valid	2
000	1	$R_{TT,nom}$ disabled, ODT on	Any valid except self refresh, read	3
000–101	0	$R_{TT,nom}$ enabled, ODT off	Any valid	2
000–101	1	$R_{TT,nom}$ enabled, ODT on	Any valid except self refresh, read	3
110 and 111	X	$R_{TT,nom}$ reserved, ODT on or off	Illegal	

- Notes:
- 1 Assumes dynamic ODT is disabled (see Dynamic ODT when enabled).
  - 2 ODT is enabled and active during most writes for proper termination, but it is not illegal for it to be off during writes.
  - 3 ODT must be disabled during reads. The  $R_{TT,nom}$  value is restricted during writes. Dynamic ODT is applicable if enabled.

Nominal ODT resistance  $R_{TT,nom}$  is defined by MR1[9,6,2], as shown in Mode Register1 (MR1) Definition. The  $R_{TT,nom}$  termination value applies to the output pins previously mentioned. DDR3 SDRAM supports multiple  $R_{TT,nom}$  values based on  $RZQ/n$  where  $n$  can be 2, 4, 6, 8, or 12 and  $RZQ$  is  $240\Omega$ .  $R_{TT,nom}$  termination is allowed any time after the DRAM is initialized, calibrated, and not performing read access, or when it is not in self refresh mode. Write accesses use  $R_{TT,nom}$  if dynamic ODT( $R_{TT}(WR)$ ) is disabled. If  $R_{TT,nom}$  is used during writes, only  $RZQ/2$ ,  $RZQ/4$ , and  $RZQ/6$  are allowed. ODT timings are summarized as well as listed in the Electrical Characteristics and AC Operating Conditions table.

Examples of nominal ODT timing are shown in conjunction with the synchronous mode of operation in Synchronous ODT Mode.



**ODT Parameters**

Symbol	Description	Begins at	Defined to	Definition for All DDR3L Speed Bins	Unit
ODTLon	ODT synchronous turn-on delay	ODT registered HIGH	$R_{TT(ON)} \pm t_{AON}$	$CWL + AL - 2$	$t_{CK}$
ODTLoff	ODT synchronous turn-off delay	ODT registered HIGH	$R_{TT(OFF)} \pm t_{AOF}$	$CWL + AL - 2$	$t_{CK}$
$t_{AONPD}$	ODT asynchronous turn-on delay	ODT registered HIGH	$R_{TT(ON)}$	2–8.5	ns
$t_{AOPFD}$	ODT asynchronous turn-off delay	ODT registered HIGH	$R_{TT(OFF)}$	2–8.5	ns
ODTH4	ODT minimum HIGH time after ODT assertion or write (BC4)	ODT registered HIGH or write registration with ODT HIGH	ODT registered LOW	$4t_{CK}$	$t_{CK}$
ODTH8	ODT minimum HIGH time after write (BL8)	Write registration with ODT HIGH	ODT registered LOW	$6t_{CK}$	$t_{CK}$
$t_{AON}$	ODT turn-on relative to ODTLon completion	Completion of ODTLon	$R_{TT(ON)}$	See Electrical Characteristics and AC Operating Conditions table	ps
$t_{AOF}$	ODT turn-off relative to ODTLoff completion	Completion of ODTLoff	$R_{TT(OFF)}$	$0.5t_{CK} \pm 0.2t_{CK}$	$t_{CK}$

## 17.1 Dynamic ODT

In certain application cases, and to further enhance signal integrity on the data bus, it is desirable that the termination strength of the DDR3 SDRAM can be changed without issuing an MRS command, essentially changing the ODT termination on the fly. With dynamic ODT (RTT(WR)) enabled, the DRAM switches from nominal ODT (RTT,nom) to dynamic ODT (RTT(WR)) when beginning a WRITE burst and subsequently switches back to nominal ODT (RTT,nom) at the completion of the WRITE burst. This requirement is supported by the dynamic ODT feature, as described below.

### Dynamic ODT Special Use Case

When DDR3 devices are architected as a single rank memory array, dynamic ODT offers a special use case: the ODT ball can be wired high (via a current limiting resistor preferred) by having RTT,nom disabled via MR1 and RTT(WR) enabled via MR2. This will allow the ODT signal not to have to be routed yet the DRAM can provide ODT coverage during write accesses. When enabling this special use case, some standard ODT spec conditions may be violated: ODT is sometimes supposed to be held low. Such ODT spec violation (ODT not LOW) is allowed under this special use case. Most notably, if Write Leveling is used, this would appear to be a problem since RTT(WR) can not be used (should be disabled) and RTT(NOM) should be used.





For Write leveling during this special use case, with the DLL locked, then RTT(NOM) may be enabled when entering Write Leveling mode and disabled when exiting Write Leveling mode. More so, RTT(NOM) must be enabled when enabling Write Leveling, via same MR1 load, and disabled when disabling Write Leveling, via same MR1 load if RTT(NOM) is to be used. ODT will turn-on within a delay of  $ODTLon + tAON + tMOD + 1CK$  (enabling via MR1) or turn-off within a delay of  $ODTloff + tAOF + tMOD + 1CK$ . As seen in the table below, between the Load Mode of MR1 and the previously specified delay, the value of ODT is uncertain. This means the DQODT termination could turn-on and then turn-off again during the period of stated uncertainty.

#### Write Leveling with Dynamic ODT Special Case

Begin $R_{TT,nom}$ Uncertainty	End $R_{TT,nom}$ Uncertainty	I/Os	$R_{TT,nom}$ Final State
MR1 load mode command: Enable Write Leveling and $R_{TT(NOM)}$	ODTLon + tAON + tMOD + 1CK	DQS, DQS#	Drive $R_{TT,nom}$ value
		DQs	No $R_{TT,nom}$
MR1 load mode command: Disable Write Leveling and $R_{TT(NOM)}$	ODTloff + tAOF + tMOD + 1CK	DQS, DQS#	No $R_{TT,nom}$
		DQs	No $R_{TT,nom}$

#### Functional Description

The dynamic ODT mode is enabled if either MR2[9] or MR2[10] is set to 1. Dynamic ODT is not supported during DLL disable mode so RTT(WR) must be disabled. The dynamic ODT function is described below:

- Two RTT values are available— $R_{TT,nom}$  and  $R_{TT(WR)}$ .
  - The value for  $R_{TT,nom}$  is preselected via MR1[9, 6, 2].
  - The value for  $R_{TT(WR)}$  is preselected via MR2[10, 9].
- During DRAM operation without READ or WRITE commands, the termination is controlled.
  - Nominal termination strength  $R_{TT,nom}$  is used.
  - Termination on/off timing is controlled via the ODT ball and latencies ODTLon and ODTLoff.
- When a WRITE command (WR, WRAP, WRS4, WRS8, WRAPS4, WRAPS8) is registered, and if dynamic ODT is enabled, the ODT termination is controlled.
  - A latency of ODTLcnw after the WRITE command: termination strength  $R_{TT,nom}$  switches to  $R_{TT(WR)}$
  - A latency of ODTLcwn8 (for BL8, fixed or OTF) or ODTLcwn4 (for BC4, fixed or OTF) after the WRITE command: termination strength  $R_{TT(WR)}$  switches back to  $R_{TT,nom}$ .



- On/off termination timing is controlled via the ODT ball and determined by ODT- Lon, ODTLoff, ODTH4, and ODTH8.
- During the tADC transition window, the value of RTT is undefined. ODT is constrained during writes and when dynamic ODT is enabled (see the table below, Dynamic ODT Specific Parameters). ODT timings listed in the ODT Parameters table in On-Die Termination (ODT) also apply to dynamic ODT mode.

**Dynamic ODT Specific Parameters**

Symbol	Description	Begins at	Defined to	Definition for All DDR3L Speed Bins	Unit
ODTLcnw	Change from $R_{TT,nom}$ to $R_{TT(WR)}$	Write registration	$R_{TT}$ switched from $R_{TT,nom}$ to $R_{TT(WR)}$	WL - 2	$^tCK$
ODTLcwn4	Change from $R_{TT(WR)}$ to $R_{TT,nom}$ (BC4)	Write registration	$R_{TT}$ switched from $R_{TT(WR)}$ to $R_{TT,nom}$	$4^tCK$ + ODTL off	$^tCK$
ODTLcwn8	Change from $R_{TT(WR)}$ to $R_{TT,nom}$ (BL8)	Write registration	$R_{TT}$ switched from $R_{TT(WR)}$ to $R_{TT,nom}$	$6^tCK$ + ODTL off	$^tCK$
$^tADC$	$R_{TT}$ change skew	ODTLcnw completed	$R_{TT}$ transition complete	$0.5^tCK \pm 0.2^tCK$	$^tCK$

**Mode Registers for  $R_{TT,nom}$**

MR1 ( $R_{TT,nom}$ )			$R_{TT,nom}$ (RZQ)	$R_{TT,nom}$ (Ohm)	$R_{TT,nom}$ Mode Restriction
M9	M6	M2			
0	0	0	Off	Off	n/a
0	0	1	RZQ/4	60	Self refresh
0	1	0	RZQ/2	120	
0	1	1	RZQ/6	40	
1	0	0	RZQ/12	20	Self refresh, write
1	0	1	RZQ/8	30	
1	1	0	Reserved	Reserved	n/a



**Mode Registers for  $R_{TT,nom}$  (Continued)**

MR1 ( $R_{TT,nom}$ )			$R_{TT,nom}$ (RZQ)	$R_{TT,nom}$ (Ohm)	$R_{TT,nom}$ Mode Restriction
M9	M6	M2			
1	1	1	Reserved	Reserved	n/a

Note: 1. RZQ =  $240\Omega$ . If  $R_{TT,nom}$  is used during WRITES, only RZQ/2, RZQ/4, RZQ/6 are allowed.

**Mode Registers for  $R_{TT(WR)}$**

MR2 ( $R_{TT(WR)}$ )		$R_{TT(WR)}$ (RZQ)	$R_{TT(WR)}$ (Ohm)
M10	M9		
0	0	Dynamic ODT off: WRITE does not affect $R_{TT,nom}$	
0	1	RZQ/4	60
1	0	RZQ/2	120
1	1	Reserved	Reserved

**Timing Diagrams for Dynamic ODT**

Title
Dynamic ODT: ODT Asserted Before and After the WRITE, BC4
Dynamic ODT: Without WRITE Command
Dynamic ODT: ODT Pin Asserted Together with WRITE Command for 6 Clock Cycles, BL8
Dynamic ODT: ODT Pin Asserted with WRITE Command for 6 Clock Cycles, BC4
Dynamic ODT: ODT Pin Asserted with WRITE Command for 4 Clock Cycles, BC4



**Dynamic ODT: ODT Asserted Before and After the WRITE, BC4**

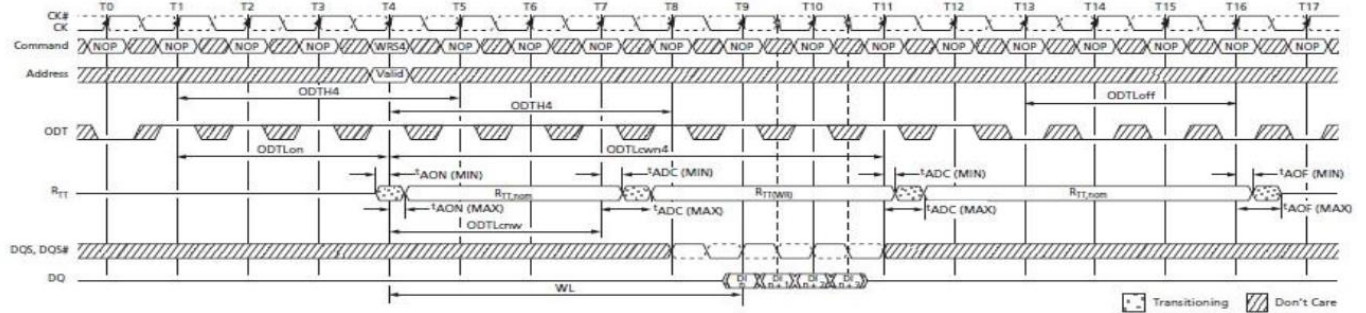

- Notes: 1. Via MRS or OTF. AL = 0, CWL = 5.  $R_{TT,nom}$  and  $R_{TT(WR)}$  are enabled.  
2. ODT<sub>H4</sub> applies to first registering ODT HIGH and then to the registration of the WRITE command. In this example, ODT<sub>H4</sub> is satisfied if ODT goes LOW at T8 (four clocks after the WRITE command).

**Dynamic ODT: Without WRITE Command**

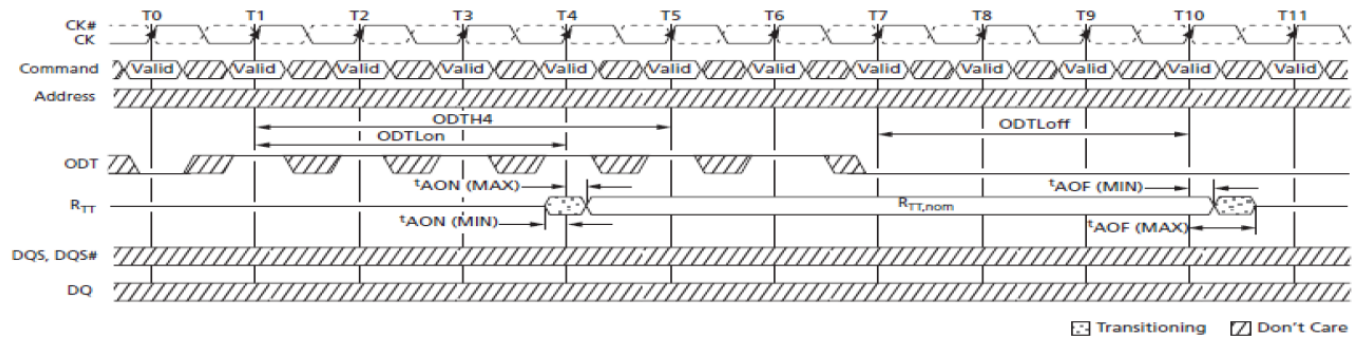

- Notes: 1. AL = 0, CWL = 5.  $R_{TT,nom}$  is enabled and  $R_{TT(WR)}$  is either enabled or disabled.  
2. ODT<sub>H4</sub> is defined from ODT registered HIGH to ODT registered LOW; in this example, ODT<sub>H4</sub> is satisfied. ODT registered LOW at T5 is also legal.



**Dynamic ODT: ODT Pin Asserted Together with WRITE Command for 6 Clock Cycles, BL8**

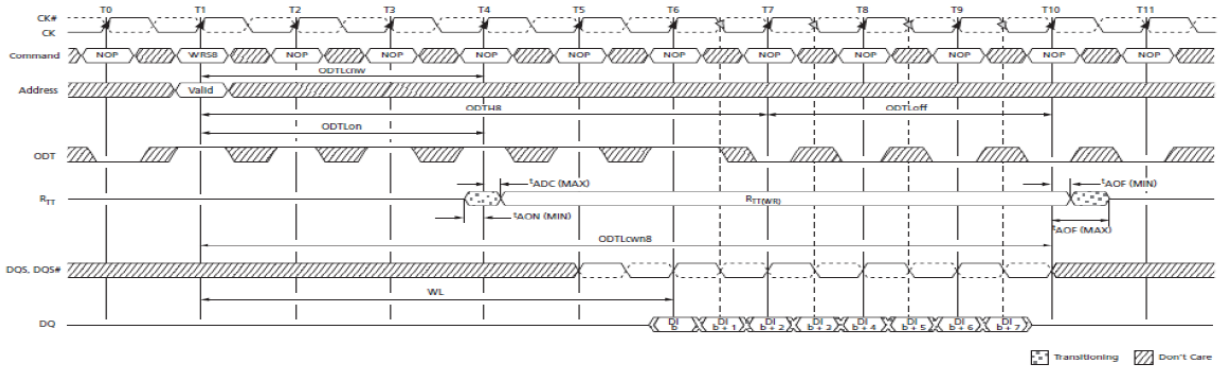

- Notes: 1. Via MRS or OTF; AL = 0, CWL = 5. If  $R_{TT,nom}$  can be either enabled or disabled, ODT can be HIGH.  $R_{TT(WR)}$  is enabled.  
2. In this example, ODT<sub>H8</sub> = 6 is satisfied exactly.

**Dynamic ODT: ODT Pin Asserted with WRITE Command for 6 Clock Cycles, BC4**

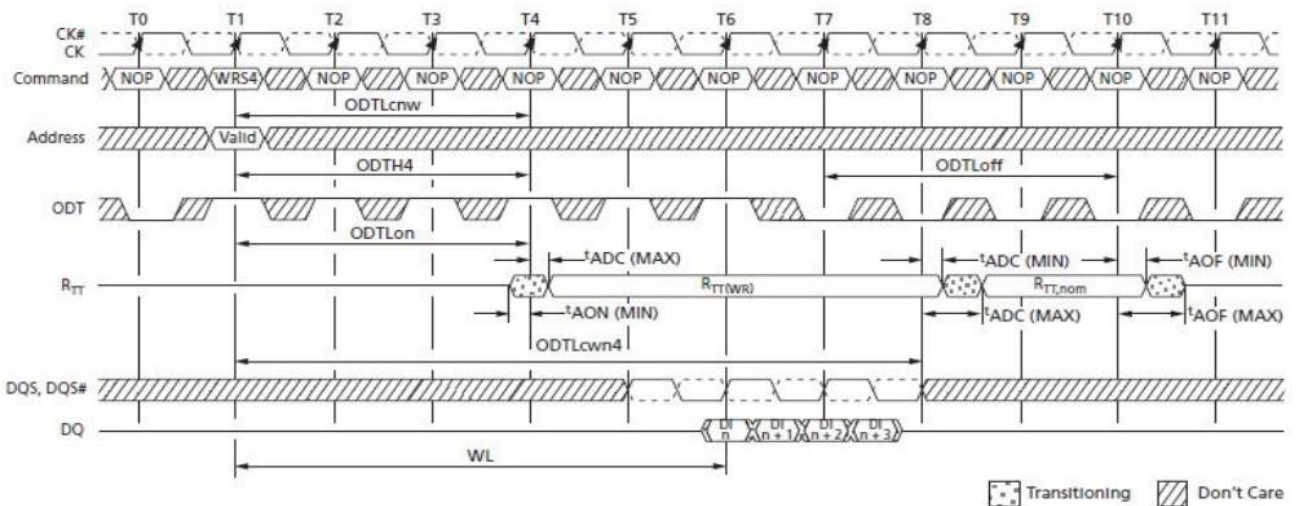

- Notes: 1. Via MRS or OTF. AL = 0, CWL = 5.  $R_{TT,nom}$  and  $R_{TT(WR)}$  are enabled.  
2. ODT<sub>H4</sub> is defined from ODT registered HIGH to ODT registered LOW, so in this example, ODT<sub>H4</sub> is satisfied. ODT registered LOW at T5 is also legal.



**Dynamic ODT: ODT Pin Asserted with WRITE Command for 4 Clock Cycles, BC4**

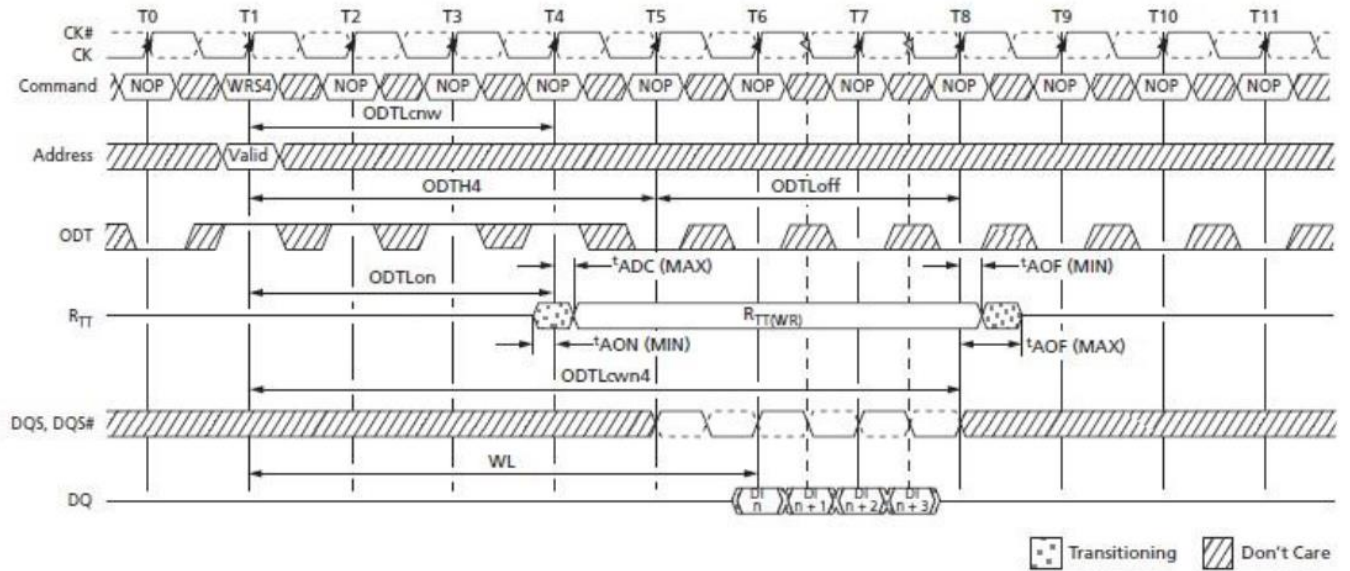

- Notes: 1. Via MRS or OTF. AL = 0, CWL = 5. R<sub>TT,nom</sub> can be either enabled or disabled. If disabled, ODT can remain HIGH. R<sub>TT(WR)</sub> is enabled.  
2. In this example ODLT4 = 4 is satisfied exactly.

CONFIDENTIAL



## 17.2 Synchronous ODT Mode

Synchronous ODT mode is selected whenever the DLL is turned on and locked and

when either RTT,nom or RTT(WR) is enabled. Based on the power-down definition, these modes are:

- Any bank active with CKE HIGH
- Refresh mode with CKE HIGH
- Idle mode with CKEHIGH
- Active power-down mode (regardless of MR0[12])
- Precharge power-down mode if DLL is enabled by MR0[12] during precharge power down

### ODT Latency and Posted ODT

In synchronous ODT mode, RTT turns on ODTLon clock cycles after ODT is sampled HIGH by a rising clock edge and turns off ODTLoff clock cycles after ODT is registered LOW by a rising clock edge. The actual on/off times varies by tAON and tAOF around each clock edge. The ODT latency is tied to the WRITE latency (WL) by  $ODTLon = WL - 2$  and  $ODTLoff = WL - 2$ . Since write latency is made up of CASWRITE latency (CWL) and additive latency (AL), the AL programmed into the mode register (MR1[4,3]) also applies to the ODT signal. The device's internal ODT signal is delayed a number of clock cycles defined by the AL relative to the external ODT signal. Thus,  $ODTLon = CWL + AL - 2$  and  $ODTLoff = CWL + AL - 2$ .

### Timing Parameters

Synchronous ODT mode uses the following timing parameters: ODTLon, ODTLoff, ODTH4, ODTH8, tAON, and tAOF. The minimum RTT turn-on time (tAON[MIN]) is the point at which the device leaves High-Z and ODT resistance begins to turn on. Maximum RTT turn-on time (tAON[MAX]) is the point at which ODT resistance is fully on. Both are measured relative to ODTLon. The minimum RTT turn-off time (tAOF[MIN]) is the point at which the device starts to turn off ODT resistance. The maximum RTT turn off time (tAOF [MAX]) is the point at which ODT has reached High-Z. Both are measured from ODTLoff. When ODT is asserted, it must remain HIGH until ODTH4 is satisfied. If a WRITE command is registered by the DRAM with ODT HIGH, then ODT must remain HIGH until ODTH4 (BC4) or ODTH8 (BL8) after the WRITE command. ODTH4 and ODTH8 are measured from ODT registered HIGH to ODT registered LOW or from the registration of a WRITE command until ODT is registered LOW.



Synchronous ODT Parameters

Symbol	Description	Begins at	Defined to	Definition for All DDR3L Speed Bins	Unit
ODTLon	ODT synchronous turn-on delay	ODT registered HIGH	$R_{TT(ON)} \pm t_{AON}$	$CWL + AL - 2$	$t_{CK}$
ODTLoff	ODT synchronous turn-off delay	ODT registered HIGH	$R_{TT(OFF)} \pm t_{AOF}$	$CWL + AL - 2$	$t_{CK}$
ODTH4	ODT minimum HIGH time after ODT assertion or WRITE (BC4)	ODT registered HIGH or write registration with ODT HIGH	ODT registered LOW	$4t_{CK}$	$t_{CK}$
ODTH8	ODT minimum HIGH time after WRITE (BL8)	Write registration with ODT HIGH	ODT registered LOW	$6t_{CK}$	$t_{CK}$
$t_{AON}$	ODT turn-on relative to ODTLon completion	Completion of ODTLon	$R_{TT(ON)}$	See Electrical Characteristics and AC Operating Conditions table	ps
$t_{AOF}$	ODT turn-off relative to ODTLoff completion	Completion of ODTLoff	$R_{TT(OFF)}$	$0.5t_{CK} \pm 0.2t_{CK}$	$t_{CK}$

Synchronous ODT

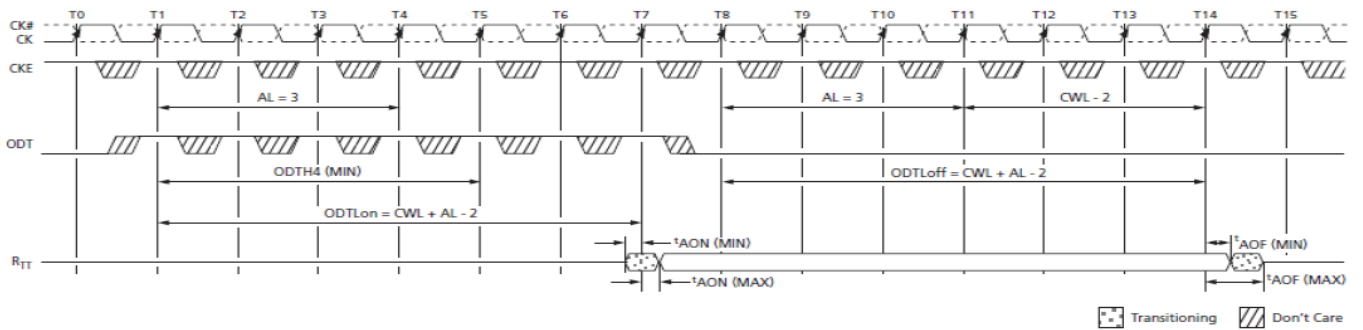

Note: 1. AL = 3; CWL = 5; ODTLon = WL = 6.0; ODTLoff = WL - 2 = 6.  $R_{TT,nom}$  is enabled.





**Synchronous ODT (BC4)**

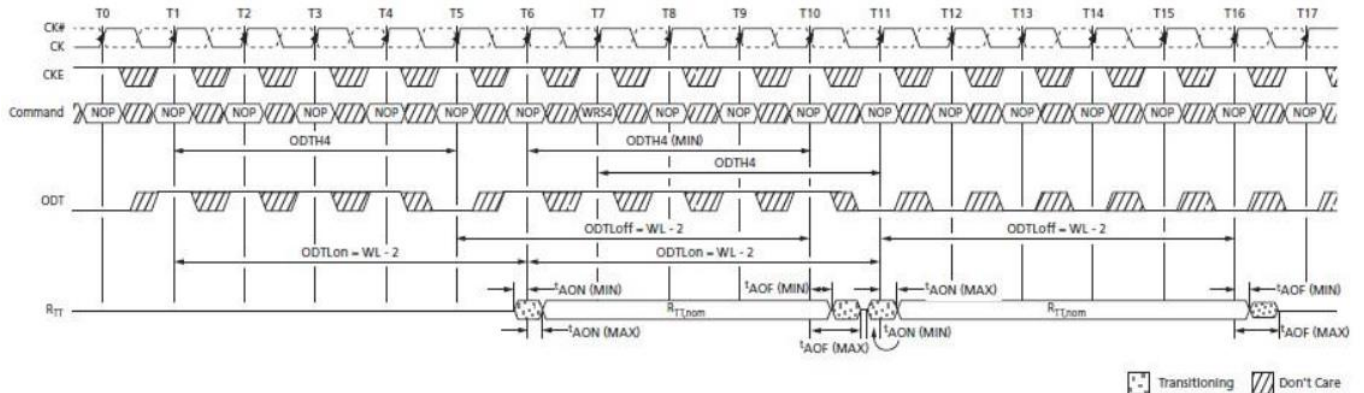

- Notes:
1. WL = 7.  $R_{TT,nom}$  is enabled.  $R_{TT(WR)}$  is disabled.
  2. ODT must be held HIGH for at least ODT<sub>H4</sub> after assertion (T1).
  3. ODT must be kept HIGH ODT<sub>H4</sub> (BC4) or ODT<sub>H8</sub> (BL8) after the WRITE command (T7).
  4. ODT<sub>H</sub> is measured from ODT first registered HIGH to ODT first registered LOW or from the registration of the WRITE command with ODT HIGH to ODT registered LOW.
  5. Although ODT<sub>H4</sub> is satisfied from ODT registered HIGH at T6, ODT must not go LOW before T11 as ODT<sub>H4</sub> must also be satisfied from the registration of the WRITE command at T7.

**ODT Off During READs**

Because the device can not terminate and drive at the same time,  $R_{TT}$  must be disabled at least one-half clock cycle before the READ preamble by driving the ODT ball LOW (if either  $R_{TT,nom}$  or  $R_{TT(WR)}$  is enabled).  $R_{TT}$  may not be enabled until the end of the postamble, as shown in the following example.

**Note:** ODT may be disabled earlier and enabled later than shown.

**ODT During READs**

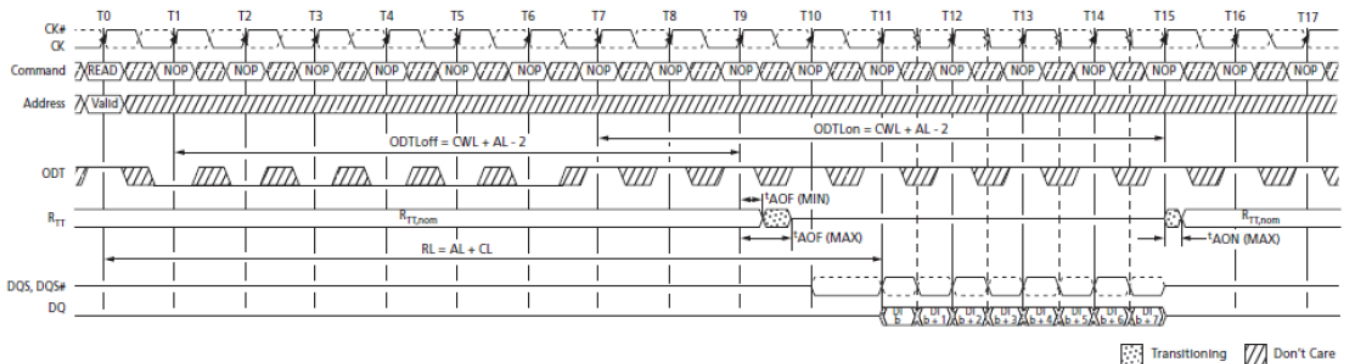

- note: 1. ODT must be disabled externally during READs by driving ODT LOW. For example, CL = 6; AL = CL - 1 = 5; RL = AL + CL = 11; CWL = 5; ODT<sub>Lon</sub> = CWL + AL - 2 = 8; ODT<sub>Loff</sub> = CWL + AL - 2 = 8.  $R_{TT,nom}$  is enabled.  $R_{TT(WR)}$  is a "Don't Care."



### 17.3 Asynchronous ODT Mode

Asynchronous ODT mode is available when the DRAM runs in DLL on mode and when either  $R_{TT,nom}$  or  $R_{TT}(WR)$  is enabled; however, the DLL is temporarily turned off in precharged power-down standby (via  $MR0[12]$ ). Additionally, ODT operates asynchronously when the DLL is synchronizing after being reset. See Power-Down Mode for definition and guidance over power-down details. In asynchronous ODT timing mode, the internal ODT command is not delayed by AL relative to the external ODT command. In asynchronous ODT mode, ODT controls  $R_{TT}$  by analog time. The timing parameters  $t_{AONPD}$  and  $t_{AOFPD}$  replace  $ODTLon/t_{AON}$  and  $ODTLoft/t_{AOF}$ , respectively, when ODT operates asynchronously. The minimum  $R_{TT}$  turn-on time ( $t_{AONPD} [MIN]$ ) is the point at which the device termination circuit leaves High-Z and ODT resistance begins to turn on. Maximum  $R_{TT}$  turn-on time ( $t_{AONPD} [MAX]$ ) is the point at which ODT resistance is fully on.  $t_{AONPD} (MIN)$  and  $t_{AONPD}(MAX)$  are measured from ODT being sampled HIGH. The minimum  $R_{TT}$  turn-off time ( $t_{AOFPD} [MIN]$ ) is the point at which the device termination circuit starts to turn off ODT resistance. Maximum  $R_{TT}$  turn-off time ( $t_{AOFPD} [MAX]$ ) is the point at which ODT has reached High-Z.  $t_{AOFPD} (MIN)$  and  $t_{AOFPD} (MAX)$  are measured from ODT being sampled LOW.

Asynchronous ODT Timing with Fast ODT Transition

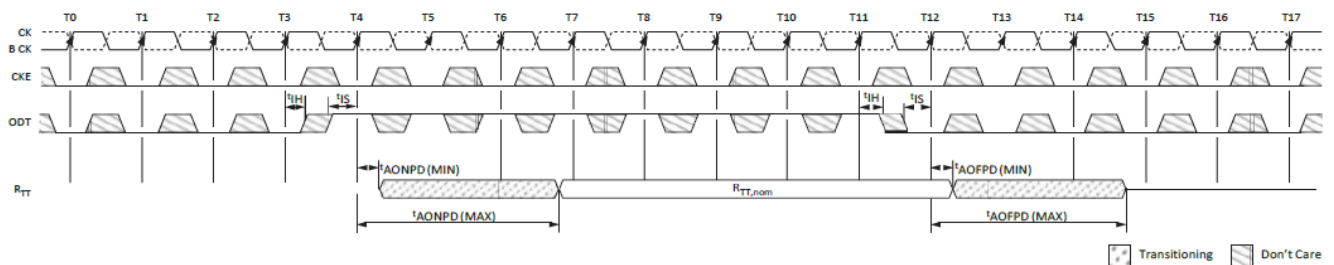

Note: 1. AL is ignored.

Asynchronous ODT Timing Parameters for All Speed Bins

Symbol	Description	Min	Max	Unit
$t_{AONPD}$	Asynchronous $R_{TT}$ turn-on delay (power-down with DLL off)	2	8.5	ns
$t_{AOFPD}$	Asynchronous $R_{TT}$ turn-off delay (power-down with DLL off)	2	8.5	ns



**Synchronous to Asynchronous ODT Mode Transition (Power-Down Entry)**

There is a transition period around power-down entry (PDE) where the DRAM's ODT may exhibit either synchronous or asynchronous behavior. This transition period occurs if the DLL is selected to be off when in precharge power-down mode by the setting MR0[12] = 0. Power-down entry begins  $t_{ANPD}$  prior to CKE first being registered LOW, and ends when CKE is first registered LOW.  $t_{ANPD}$  is equal to the greater of  $ODT_{Loff} + 1t_{CK}$  or  $ODT_{Lon} + 1t_{CK}$ . If a REFRESH command has been issued, and it is in progress when CKE goes LOW, power-down entry ends  $t_{RFC}$  after the REFRESH command, rather than when CKE is first registered LOW. Power-down entry then becomes the greater of  $t_{ANPD}$  and  $t_{RFC}$  - REFRESH command to CKE registered LOW. ODT assertion during power-down entry results in an RTT change as early as the lesser of  $t_{AONPD} (MIN)$  and  $ODT_{Lon} \times t_{CK} + t_{AON} (MIN)$ , or as late as the greater of  $t_{AONPD} (MAX)$  and  $ODT_{Lon} \times t_{CK} + t_{AON} (MAX)$ . ODT de-assertion during power down entry can result in an RTT change as early as the lesser of  $t_{AOFPD} (MIN)$  and  $ODT_{Loff} \times t_{CK} + t_{AOF} (MIN)$ , or as late as the greater of  $t_{AOFPD} (MAX)$  and  $ODT_{Loff} \times t_{CK} + t_{AOF} (MAX)$ .

summarizes these parameters.

If AL has a large value, the uncertainty of the state of RTT becomes quite large. This is because  $ODT_{Lon}$  and  $ODT_{Loff}$  are derived from the WL; and WL is equal to  $CWL + AL$ . shows three different cases:

- ODT\_A: Synchronous behavior before  $t_{ANPD}$ .
- ODT\_B: ODT state changes during the transition period with  $t_{AONPD} (MIN) < ODT_{Lon} \times t_{CK} + t_{AON} (MIN)$  and  $t_{AONPD} (MAX) > ODT_{Lon} \times t_{CK} + t_{AON} (MAX)$ .
- ODT\_C: ODT state changes after the transition period with asynchronous behavior.



**ODT Parameters for Power-Down (DLL Off) Entry and Exit Transition Period**

Description	Min	Max
Power-down entry transition period (power-down entry)	Greater of: $t_{ANPD}$ or $t_{RFC}$ - refresh to CKE LOW	
Power-down exit transition period (power-down exit)	$t_{ANPD} + t_{XPDLL}$	
ODT to $R_{TT}$ turn-on delay (ODT <sub>Lon</sub> = WL - 2)	Lesser of: $t_{AONPD}$ (MIN) (2ns) or $ODT_{Lon} \times t_{CK} + t_{AON}$ (MIN)	Greater of: $t_{AONPD}$ (MAX) (8.5ns) or $ODT_{Lon} \times t_{CK} + t_{AON}$ (MAX)
ODT to $R_{TT}$ turn-off delay (ODT <sub>Loff</sub> = WL - 2)	Lesser of: $t_{AOFPD}$ (MIN) (2ns) or $ODT_{Loff} \times t_{CK} + t_{AOF}$ (MIN)	Greater of: $t_{AOFPD}$ (MAX) (8.5ns) or $ODT_{Loff} \times t_{CK} + t_{AOF}$ (MAX)
$t_{ANPD}$	WL - 1 (greater of ODT <sub>Loff</sub> + 1 or ODT <sub>Lon</sub> + 1)	

**Synchronous to Asynchronous Transition During Precharge Power-Down (DLL Off) Entry**

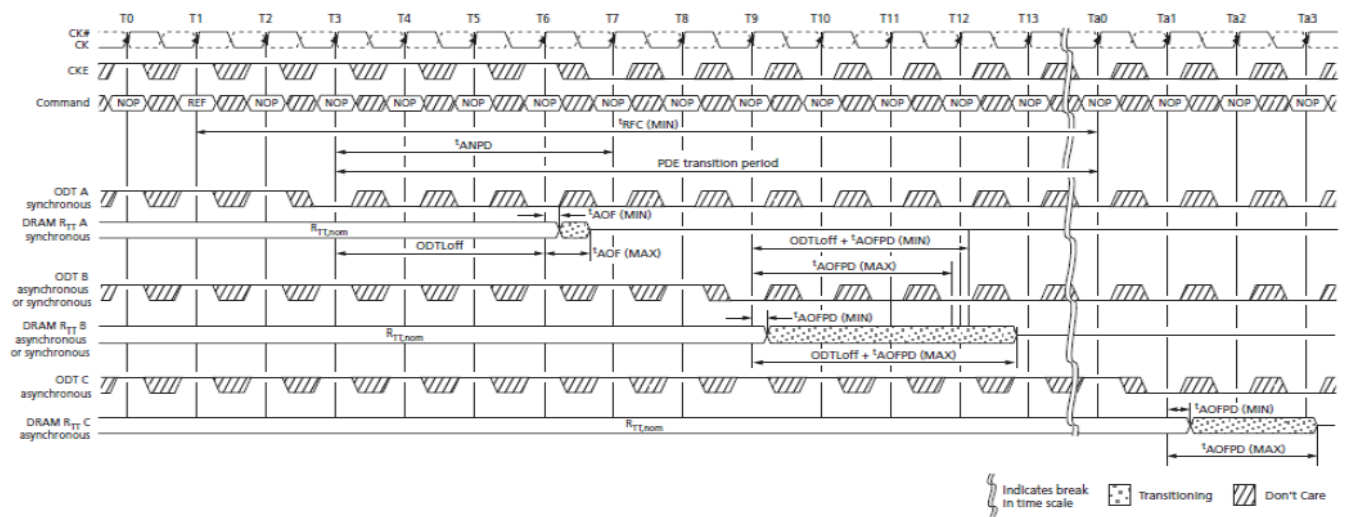

Note: 1. AL = 0; CWL = 5; ODTL(off) = WL - 2 = 3.



## 17.4 Asynchronous to Synchronous ODT Mode Transition (Power-Down Exit)

The DRAM's ODT can exhibit either asynchronous or synchronous behavior during power-down exit (PDX). This transition period occurs if the DLL is selected to be off when in precharge power-down mode by setting MR0[12] to 0. Power-down exit begins  $t_{ANPD}$  prior to CKE first being registered HIGH, and ends  $t_{XPDLL}$  after CKE is first registered HIGH.  $t_{ANPD}$  is equal to the greater of  $ODT_{Loff} + 1t_{CK}$  or  $ODT_{Lon} + 1t_{CK}$ . The transition period is  $t_{ANPD} + t_{XPDLL}$ . ODT assertion during power-down exit results in an RTT change as early as the lesser of  $t_{AONPD}(\text{MIN})$  and  $ODT_{Lon} \times t_{CK} + t_{AON}(\text{MIN})$ , or as late as the greater of  $t_{AONPD}(\text{MAX})$  and  $ODT_{Lon} \times t_{CK} + t_{AON}(\text{MAX})$ . ODT de-assertion during power-down exit may result in an RTT change as early as the lesser of  $t_{AOFPD}(\text{MIN})$  and  $ODT_{Loff} \times t_{CK} + t_{AOF}(\text{MIN})$ , or as late as the greater of  $t_{AOFPD}(\text{MAX})$  and  $ODT_{Loff} \times t_{CK} + t_{AOF}(\text{MAX})$ .

summarizes these parameters.

If AL has a large value, the uncertainty of the RTT state becomes quite large. This is because  $ODT_{Lon}$  and  $ODT_{Loff}$  are derived from WL, and WL is equal to  $CWL + AL$ . shows three different cases:

- ODT C: Asynchronous behavior before  $t_{ANPD}$ .
- ODTB: ODT state changes during the transition period, with  $t_{AOFPD}(\text{MIN}) < ODT_{Loff} \times t_{CK} + t_{AOF}(\text{MIN})$ , and  $ODT_{Loff} \times t_{CK} + t_{AOF}(\text{MAX}) > t_{AOFPD}(\text{MAX})$ .
- ODT A: ODT state changes after the transition period with synchronous response.



Asynchronous to Synchronous Transition During Precharge Power-Down (DLL Off) Exit

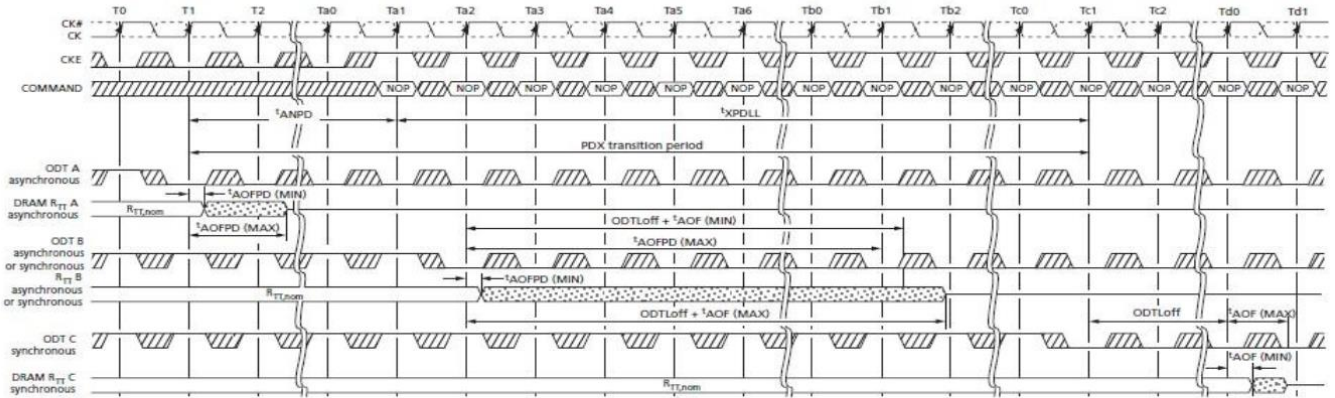

Note: 1. CL = 6; AL = CL - 1; CWL = 5; ODTLoFF = WL - 2 = 8.

Asynchronous to Synchronous Transition During Precharge Power-Down (DLL Off) Exit

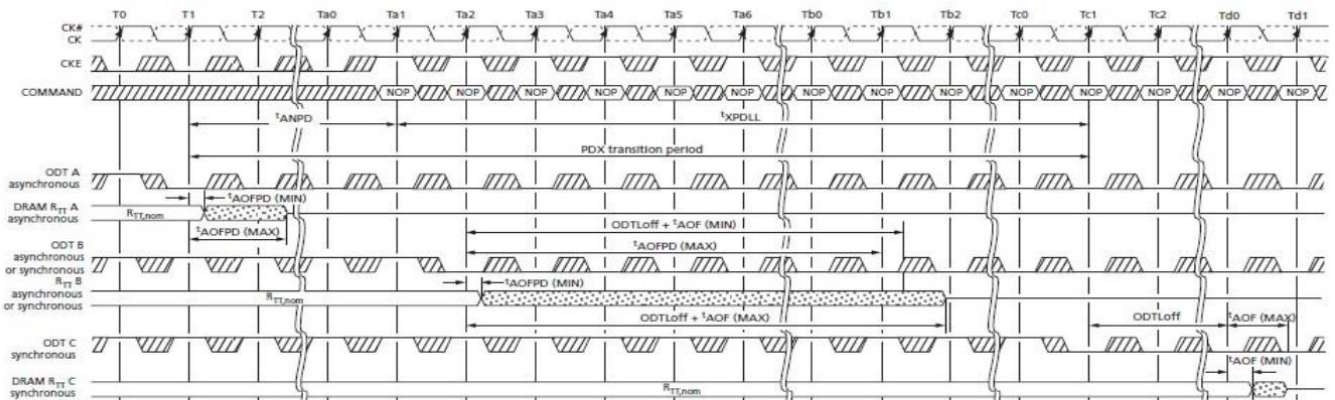

Note: 1. CL = 6; AL = CL - 1; CWL = 5; ODTLoFF = WL - 2 = 8.



### Asynchronous to Synchronous ODT Mode Transition (Short CKE Pulse)

If the time in the precharge power-down or idle states is very short (short CKE LOW pulse), the power-down entry and power-down exit transition periods overlap. When overlap occurs, the response of the DRAM's RTT to a change in the ODT state can be synchronous or asynchronous from the start of the power-down entry transition period to the end of the power-down exit transition period, even if the entry period ends later than the exit period. If the time in the idle state is very short (short CKE HIGH pulse), the power-down exit and power-down entry transition periods overlap. When this overlap occurs, the response of the DRAM's RTT to a change in the ODT state may be synchronous or asynchronous from the start of power-down exit transition period to the end of the power-down entry transition period.

Transition Period for Short CKE LOW Cycles with Entry and Exit Period Overlapping

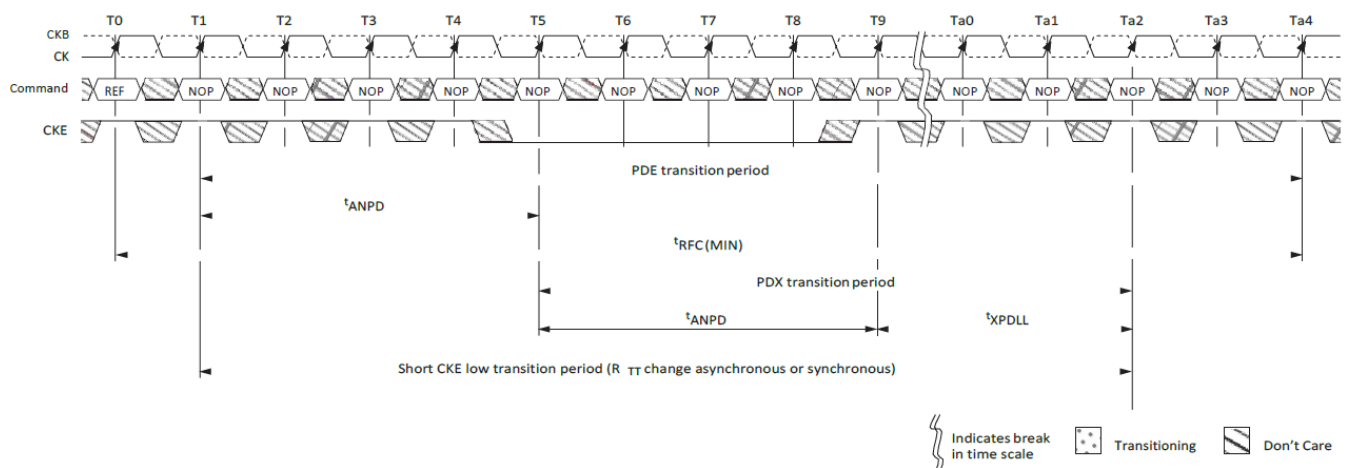

Note: 1. AL = 0, WL = 5,  $t'_{ANPD} = 4$ .



**Transition Period for Short CKE HIGH Cycles with Entry and Exit Period Overlapping**

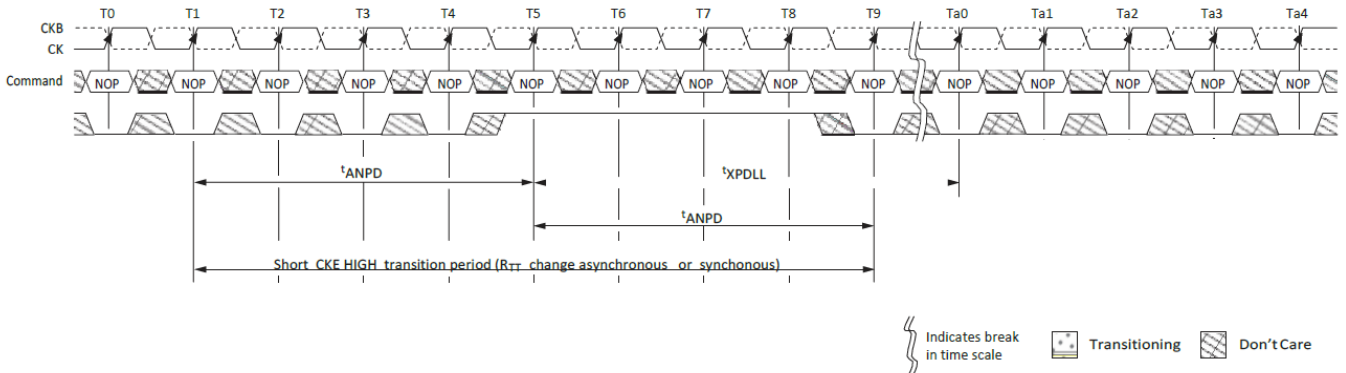

Note: 1. AL = 0, WL = 5,  $t'ANPD = 4$ .

CONFIDENTIAL

