

## 700V N-Channel MOSFET

### FEATURES

- Fast switching
- 100% avalanche tested
- Improved dv/dt capability

### APPLICATIONS

- Switch Mode Power Supply (SMPS)
- Uninterruptible Power Supply (UPS)
- Power Factor Correction (PFC)

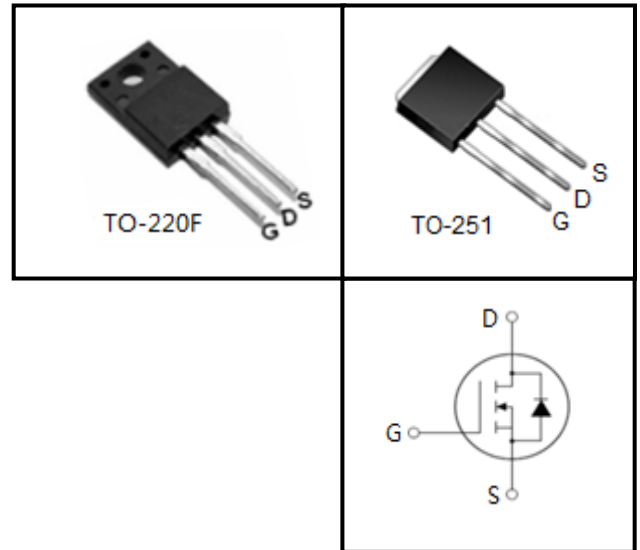

### Device Marking and Package Information

Device	Package	Marking
CS7N70F	TO-220F	CS7N70F
CS7N70U	TO-251	CS7N70U

### Absolute Maximum Ratings $T_C = 25^\circ\text{C}$ , unless otherwise noted

Parameter	Symbol	Value		Unit
		TO-220F	TO-251	
Drain-Source Voltage ( $V_{GS} = 0V$ )	$V_{DSS}$	700		V
Continuous Drain Current	$I_D$	7		A
Pulsed Drain Current (note1)	$I_{DM}$	28		A
Gate-Source Voltage	$V_{GSS}$	$\pm 30$		V
Single Pulse Avalanche Energy (note2)	$E_{AS}$	218		mJ
Avalanche Current (note1)	$I_{AS}$	6.6		A
Repetitive Avalanche Energy (note1)	$E_{AR}$	130		mJ
Power Dissipation ( $T_C = 25^\circ\text{C}$ )	$P_D$	64	83	W
Operating Junction and Storage Temperature Range	$T_J, T_{stg}$	-55~+150		$^\circ\text{C}$

### Thermal Resistance

Parameter	Symbol	Value		Unit
		TO-220F	TO-251	
Thermal Resistance, Junction-to-Case	$R_{thJC}$	1.95	1.5	$^\circ\text{C/W}$
Thermal Resistance, Junction-to-Ambient	$R_{thJA}$	62.5	60	

<b>Specifications</b> $T_J = 25^\circ\text{C}$ , unless otherwise noted						
Parameter	Symbol	Test Conditions	Value			Unit
			Min.	Typ.	Max.	
<b>Static</b>						
Drain-Source Breakdown Voltage	$V_{(BR)DSS}$	$V_{GS} = 0V, I_D = 250\mu A$	700	--	--	V
Zero Gate Voltage Drain Current	$I_{DSS}$	$V_{DS} = 700V, V_{GS} = 0V, T_J = 25^\circ\text{C}$	--	--	1	$\mu A$
Gate-Source Leakage	$I_{GSS}$	$V_{GS} = \pm 30V$	--	--	$\pm 100$	nA
Gate-Source Threshold Voltage	$V_{GS(th)}$	$V_{DS} = V_{GS}, I_D = 250\mu A$	3.0	--	4.0	V
Drain-Source On-Resistance (Note3)	$R_{DS(on)}$	$V_{GS} = 10V, I_D = 3.5A$	--	1.15	1.4	$\Omega$
<b>Dynamic</b>						
Input Capacitance	$C_{iss}$	$V_{GS} = 0V,$ $V_{DS} = 25V,$ $f = 1.0\text{MHz}$	--	1010	--	pF
Output Capacitance	$C_{oss}$		--	100	--	
Reverse Transfer Capacitance	$C_{rss}$		--	15	--	
Total Gate Charge	$Q_g$	$V_{DD} = 560V, I_D = 7A,$ $V_{GS} = 10V$	--	35	--	nC
Gate-Source Charge	$Q_{gs}$		--	5	--	
Gate-Drain Charge	$Q_{gd}$		--	19	--	
Turn-on Delay Time	$t_{d(on)}$	$V_{DD} = 350V, I_D = 7A,$ $R_G = 25\Omega$	--	40	--	ns
Turn-on Rise Time	$t_r$		--	25	--	
Turn-off Delay Time	$t_{d(off)}$		--	152	--	
Turn-off Fall Time	$t_f$		--	39	--	
<b>Drain-Source Body Diode Characteristics</b>						
Continuous Body Diode Current	$I_S$	$T_C = 25^\circ\text{C}$	--	--	7	A
Pulsed Diode Forward Current	$I_{SM}$		--	--	28	
Body Diode Voltage	$V_{SD}$	$T_J = 25^\circ\text{C}, I_{SD} = 3.5A, V_{GS} = 0V$	--	--	1.4	V
Reverse Recovery Time	$t_{rr}$	$V_{GS} = 0V, I_S = 7A,$ $di_F/dt = 100A/\mu s$	--	580	--	ns
Reverse Recovery Charge	$Q_{rr}$		--	1.87	--	$\mu C$

**Notes**

1. Repetitive Rating: Pulse width limited by maximum junction temperature
2.  $L=10\text{mH}, V_{DD} = 50V, R_G = 25\Omega$ , Starting  $T_J = 25^\circ\text{C}$
3. Pulse Test: Pulse width  $\leq 325\mu s$ , Duty Cycle  $\leq 1\%$

**Typical Characteristics**  $T_J = 25^\circ\text{C}$ , unless otherwise noted

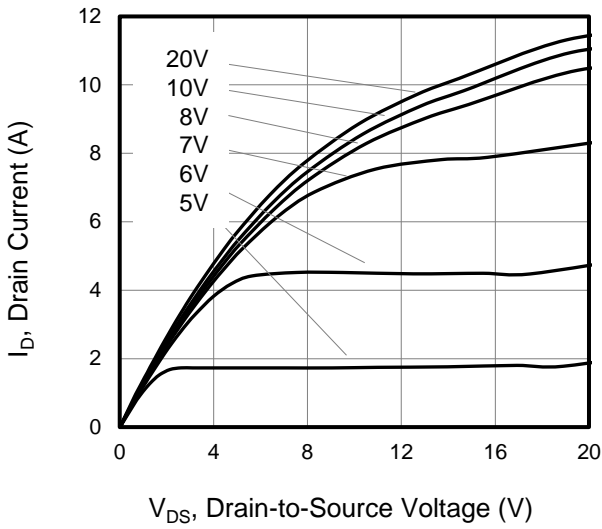
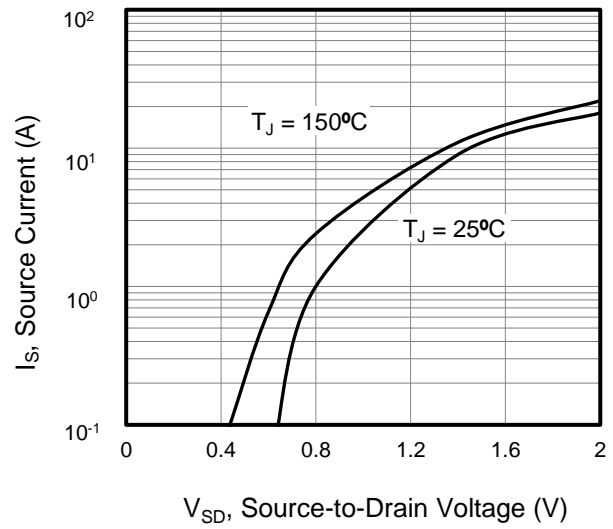
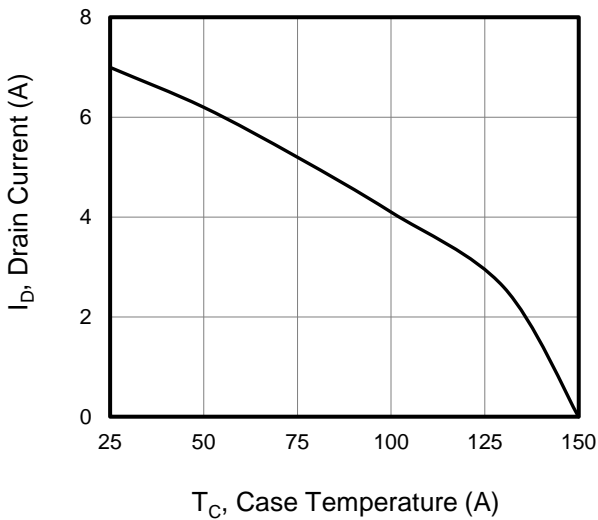
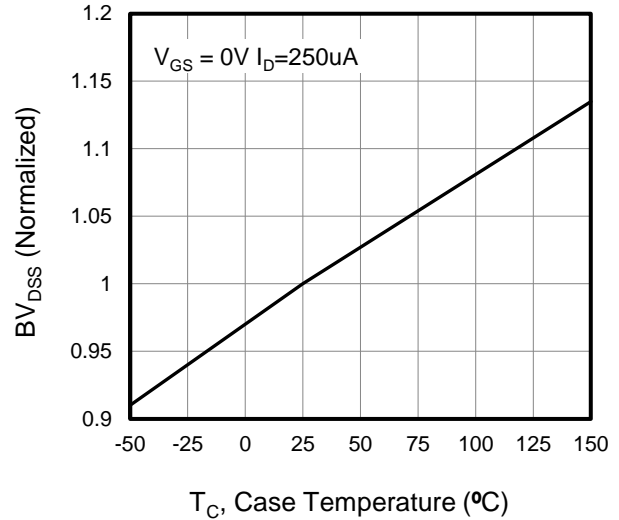
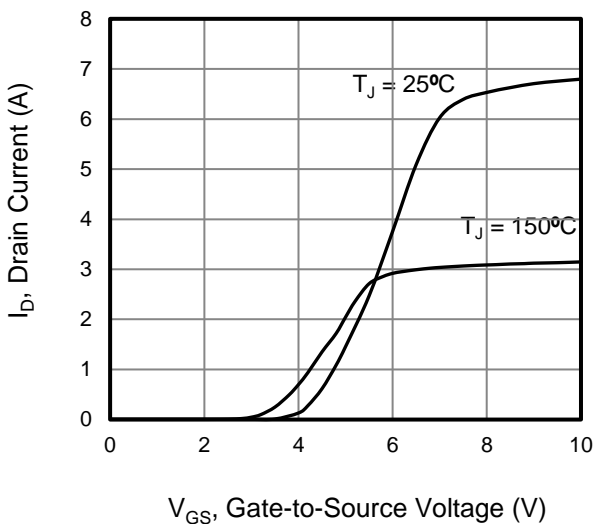
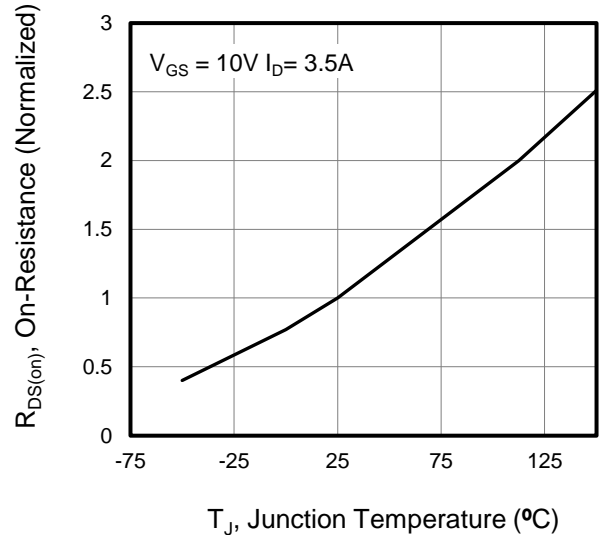
**Figure 1. Output Characteristics ( $T_J = 25^\circ\text{C}$ )**

**Figure 2. Body Diode Forward Voltage**

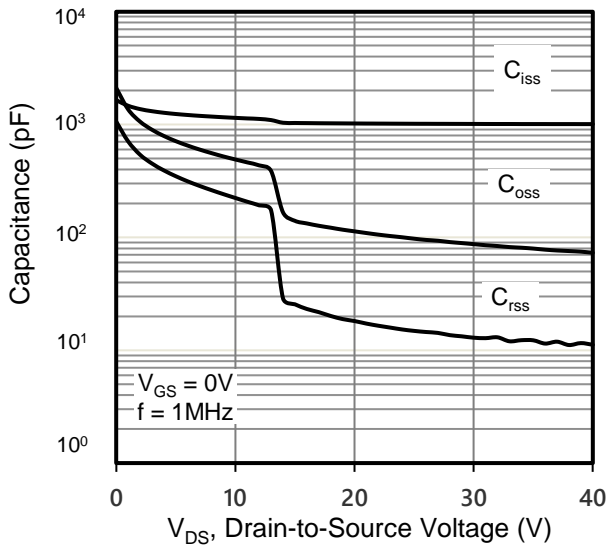
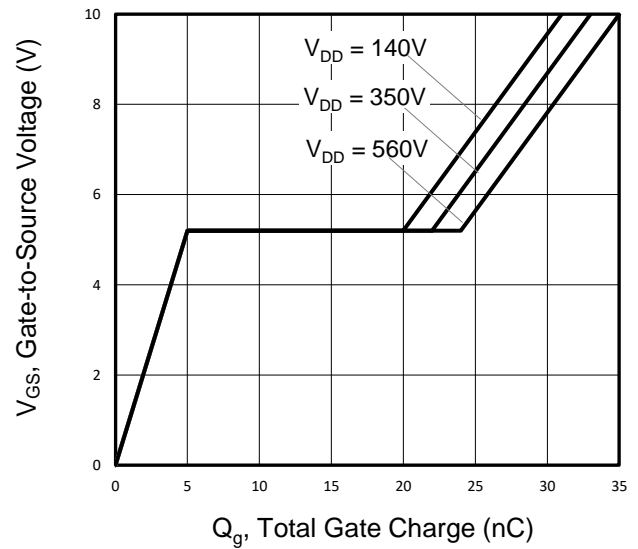
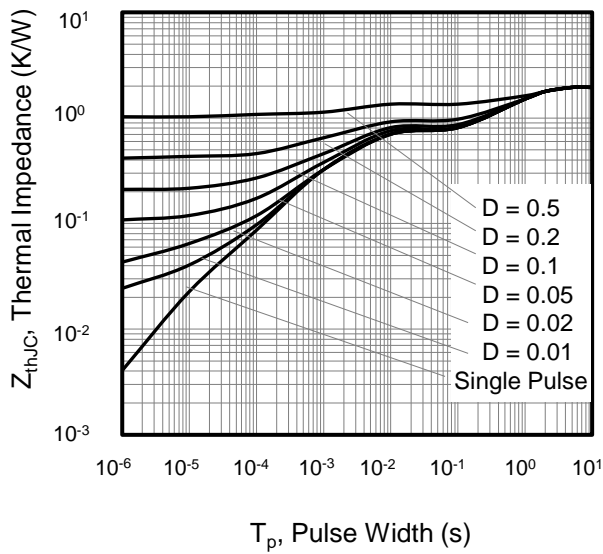
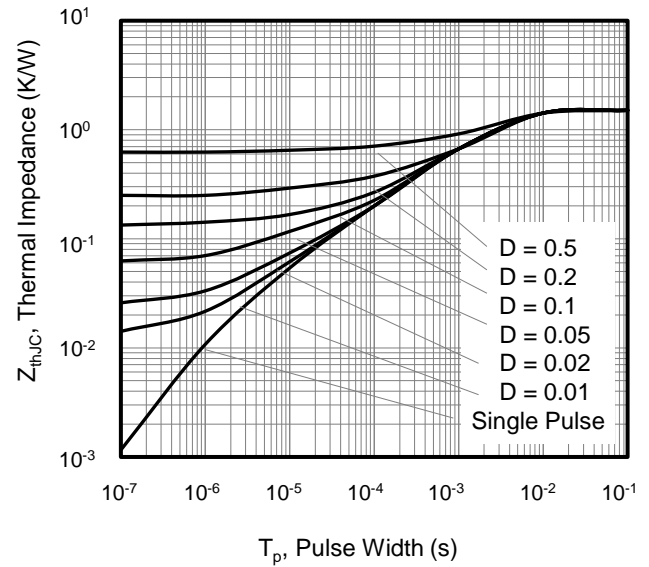
**Figure 3. Drain Current vs. Temperature**

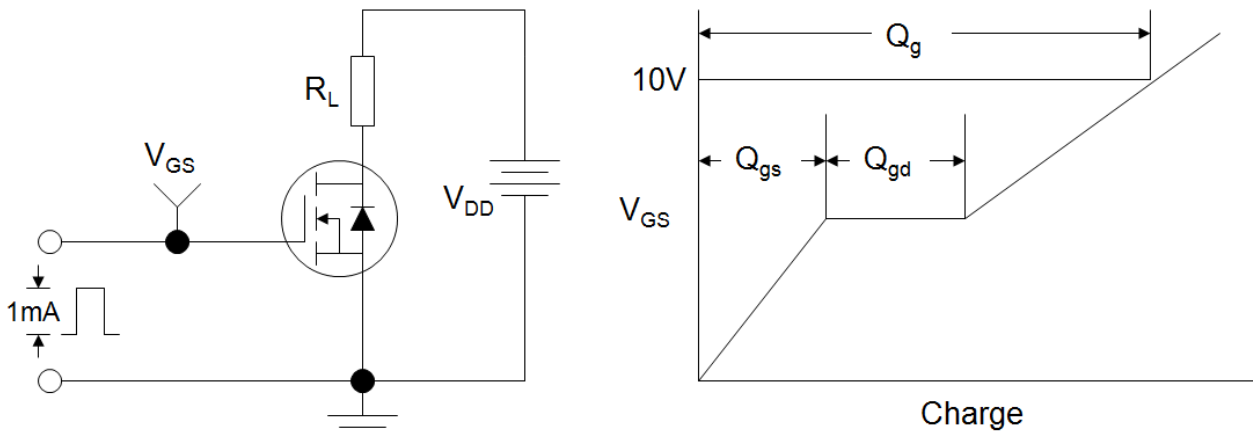
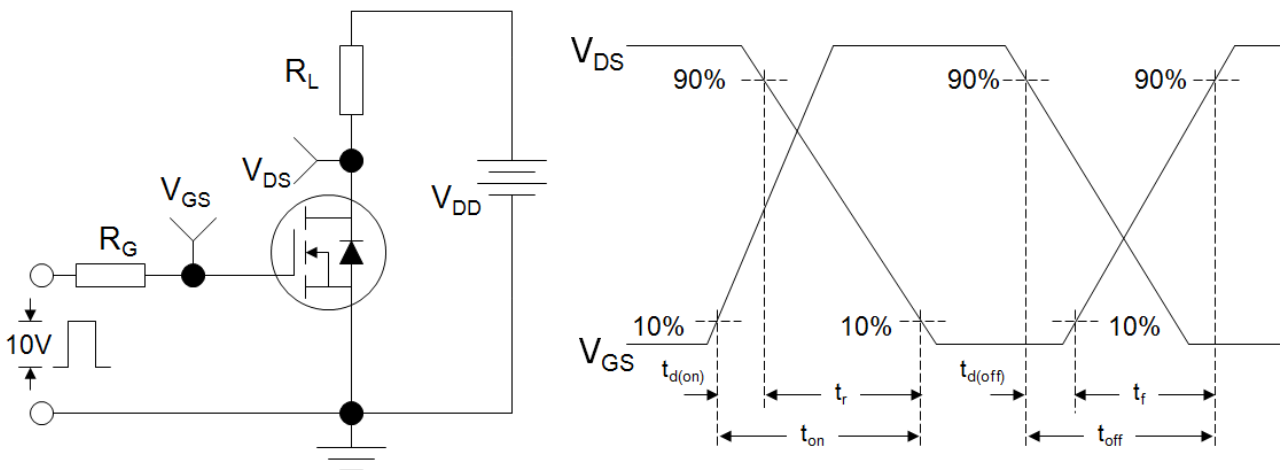
**Figure 4.  $BV_{DSS}$  Variation vs. Temperature**

**Figure 5. Transfer Characteristics**

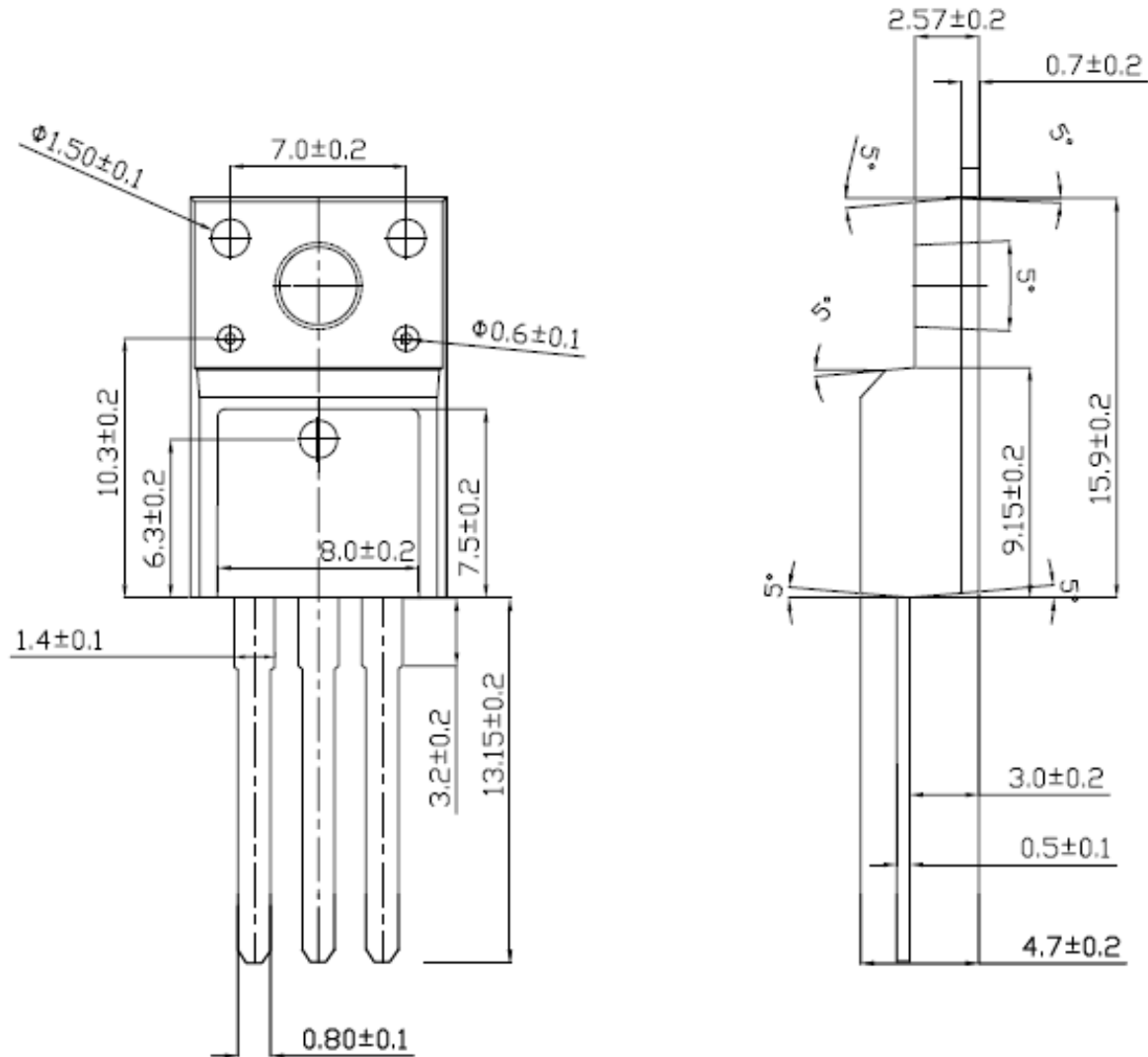
**Figure 6. On-Resistance vs. Temperature**

**Typical Characteristics**  $T_J = 25^\circ\text{C}$ , unless otherwise noted

**Figure 7. Capacitance**

**Figure 8. Gate Charge**

**Figure 9. Transient Thermal Impedance**
**TO-220F**

**Figure 9. Transient Thermal Impedance**
**TO-251**

**Figure A: Gate Charge Test Circuit and Waveform**

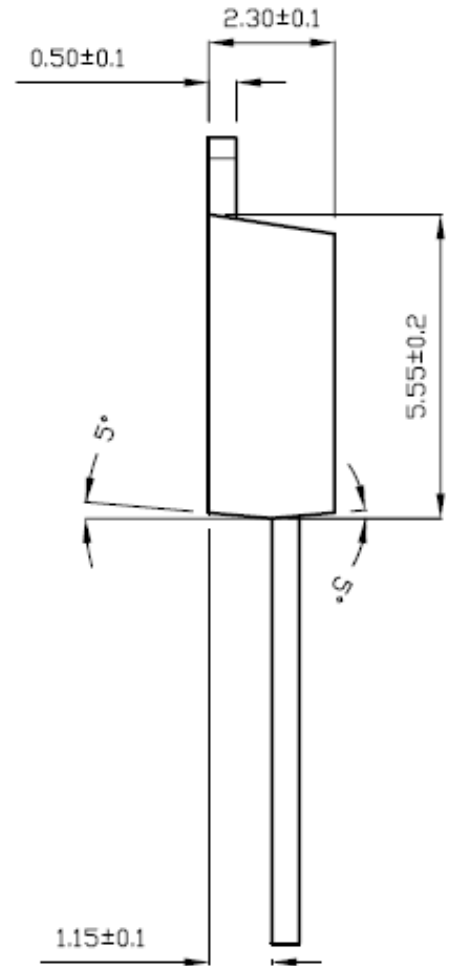
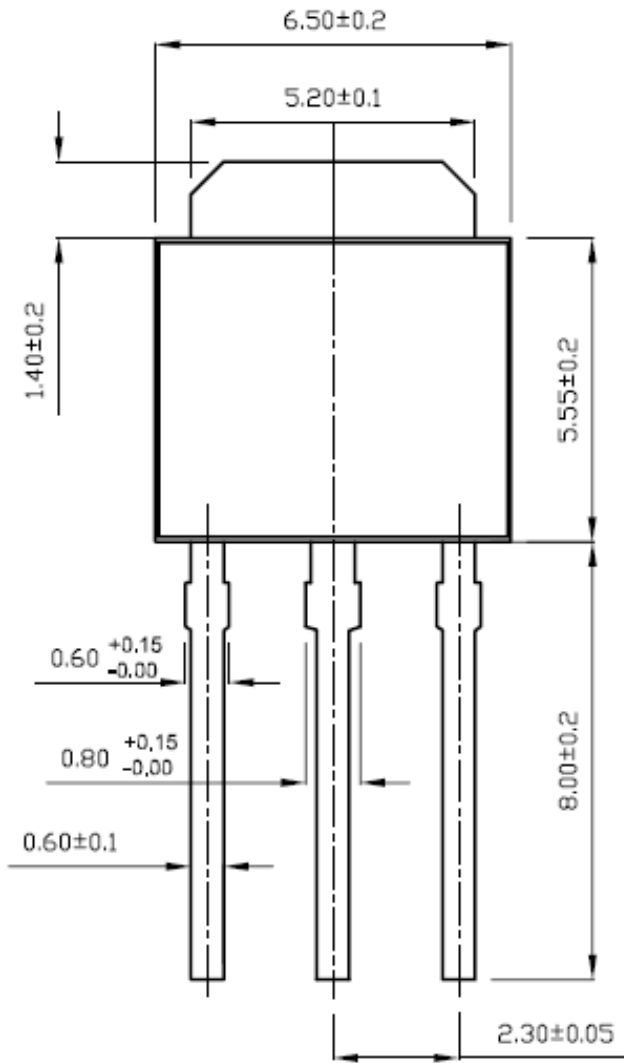
**Figure B: Resistive Switching Test Circuit and Waveform**

**Figure C: Unclamped Inductive Switching Test Circuit and Waveform**

**TO-220F**



**TO-251**



## **Disclaimer**

All product specifications and data are subject to change without notice.

For documents and material available from this datasheet, Suzhou Convert does not warrant or assume any legal liability or responsibility for the accuracy, completeness of any product or technology disclosed hereunder.

No license, express or implied, by estoppels or otherwise, to any intellectual property rights is granted by this document or by any conduct of Suzhou Convert.

The products shown herein are not designed for use in medical, life-saving, or life-sustaining applications unless. Customers using or selling Suzhou Convert products not expressly indicated for use in such applications do so entirely at their own risk and agree to fully indemnify Suzhou Convert for any damages arising or resulting from such use or sale.

Suzhou Convert disclaims any and all liability arising out of the use or application of any product described herein or of any information provided herein to the maximum extent permitted by law. The product specifications do not expand or otherwise modify Suzhou Convert's terms and conditions of purchase, including but not limited to the warranty expressed therein, which apply to these products.

Suzhou Convert Semiconductor CO., Ltd. strives to supply high-quality high-reliability products. However, any and all semiconductor products fail with some probability. It is possible that these probabilistic failures could give rise to accidents or events that could endanger human lives that could give rise to smoke or fire, or that could cause damage to other property. When designing equipment, adopt safety measures so that these kinds of accidents or events cannot occur. Such measures include but are not limited to protective circuits and error prevention circuits for safe design, redundant design, and structural design.

In the event that any or all Suzhou Convert products(including technical data, services) described or contained herein are controlled under any of applicable local export control laws and regulations, such products must not be exported without obtaining the export license from the authorities concerned in accordance with the above law.

Information (including circuit diagrams and circuit parameters) herein is for example only; it is not guaranteed for volume production. Suzhou Convert believes information herein is accurate and reliable, but no guarantees are made or implied regarding its use or any infringements of intellectual property rights or other rights of third parties.