

# SPECIFICATION FOR APPROVAL

CUSTOMER : \_\_\_\_\_

PRODUCT TYPE : SMD XTAL 2.0 × 1.6

NOMINAL FREQ. : 24.000000MHz

TXC P/N : 8Y24000011

REVISION : A1

CUSTOMER P/N : \_\_\_\_\_

PM / SALES : \_\_\_\_\_

DATE : \_\_\_\_\_

CUSTOMER SIGNATURE & Date \_\_\_\_\_

\_\_\_\_\_

- (1) TXC requires one copy returned with signature and title of authorized individual that signifies acceptance of the attached specifications.
- (2) Orders received and accepted by TXC after return of signed copy of specification will be produced per these specifications.
- (3) Any changes to these specifications must be agreed upon by both parties and new revision of the Product Specification Sheet will be issued.
- (4) Any issuance of purchase order prior to consigning back the Approval page of "Specification Sheets" from customers will be regarded as the agreement on the contents of these specifications.

Attachment: Product Specification Sheet

- 1
- 2
- 3
- 4
- 5

**RoHS Compliant**



**TXC CORPORATION**

4F, NO. 16, Sec. 2 Chung Yang S Rd., Peitou, Taipei, Taiwan.

TEL : 886-2-2894-1202 , 886-2-2895-2201 FAX : 886-2-2894-1206 , 886-2-2895-6207

www.txccorp.com

# PRODUCT SPECIFICATION SHEET

PRODUCT TYPE : SMD XTAL 2.0 × 1.6

NOMINAL FREQ. : 24.000000MHz

TXC P/N : 8Y24000011

REVISION : A1

PE/RD	QA	MFG
<i>Mike Chiu</i>	<i>Chester Ho</i>	<i>Rick Lo</i>
Mike Chiu	Chester Ho	Rick Lo
8/28/12	9/4/12	8/30/2012

**NOTE:**

- (1)Lead Free Products are "Directive 2002/95/EC of The European Parliament of 27 January 2003 on the restriction of the use of certain hazardous substances (RoHS) in electrical and electronic equipment" Compliant (Attachment: SGS Test Report).
- (2)Revision "Sx" is for engineering samples only. PE/RD's approval required.
- (3)Revision "Ax" is production ready. PE, QA and MFG's approval required

**RoHS Compliant**



<u>Rev</u>	<u>Revise page</u>	<u>Revise contents</u>	<u>Date</u>	<u>Ref.No.</u>	<u>Reviser</u>
A1	N/A	Initial released	27-Aug-12	N/A	Yachuan Miao

## ■ ELECTRICAL SPECIFICATIONS

### Standard atmospheric conditions

Unless otherwise specified, the standard range of atmospheric conditions for making measurement and tests are as follow:

Ambient temperature :  $25 \pm 10^{\circ}\text{C}$   
 Relative humidity : 40%~70%

If there is any doubt about the results, measurement shall be made within the following limits:

Ambient temperature :  $25 \pm 3^{\circ}\text{C}$   
 Relative humidity : 40%~70%

### Measure equipment

Electrical characteristics measured by HP E5100A or equivalent.

### Crystal cutting type

The crystal is using AT CUT (thickness shear mode).

### Unit Weight:

0.005±0.001 g/pcs

	Parameters	Symbol	Electrical Spec.				Notes
			Min.	Typ.	Max.	Units	
1	Nominal Frequency	FL	24.000000			MHz	-
2	Oscillation Mode	-	Fundamental			-	-
3	Load Capacitance	CL	10			pF	-
4	Frequency Tolerance	-	±20			ppm	at 25 °C ± 3 °C
5	Frequency Stability	-	±20			ppm	Over Operating Temp. Range (Reference 25°C)
6	Operating Temperature	-	-20	~	70	°C	-
7	Aging	-	±3			ppm	1st Year
8	Drive Level	DL	-	100	-	μW	-
9	Equivalent Series Resistance	ESR	-	-	50	Ω	-
10	Insulation Resistance	-	500	-	-	MΩ	at DC 100V
11	Storage Temperature Range	-	-40	~	85	°C	-

**■ DIMENSIONS**

(Unit:mm)

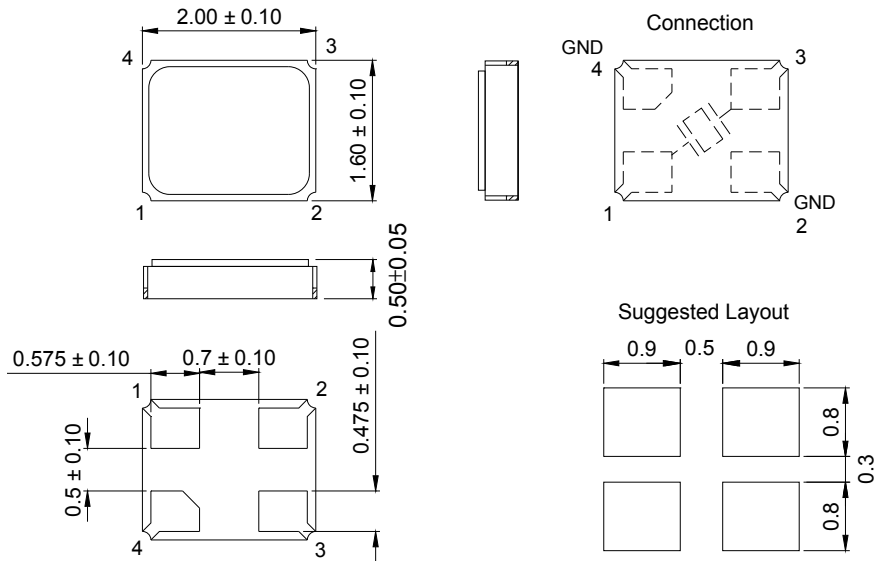

**■ MARKING**

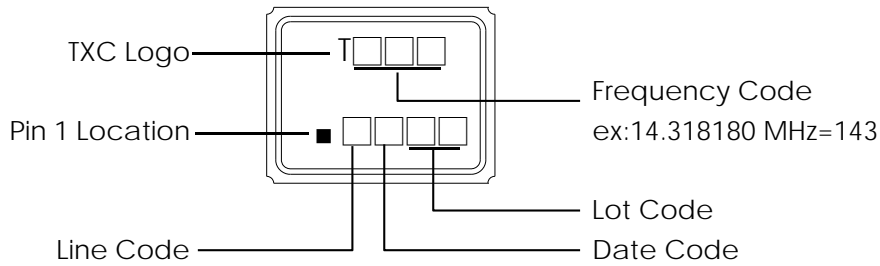

**Date Code:**

YEAR \ MONTH				MONTH											
				JAN	FEB	MAR	APR	MAY	JUN	JUL	AUG	SEP	OCT	NOV	DEC
2005	2009	2013	2017	A	B	C	D	E	F	G	H	J	K	L	M
2006	2010	2014	2018	N	P	Q	R	S	T	U	V	W	X	Y	Z
2007	2011	2015	2019	a	b	c	d	e	f	g	h	j	k	l	m
2008	2012	2016	2020	n	p	q	r	s	t	u	v	w	x	y	z

\*This date code will be cycled every four years

**Production location: Taiwan**

**■ SUGGESTED REFLOW PROFILE**

Total time : 200 sec. Max.

Solder melting point : 220°C

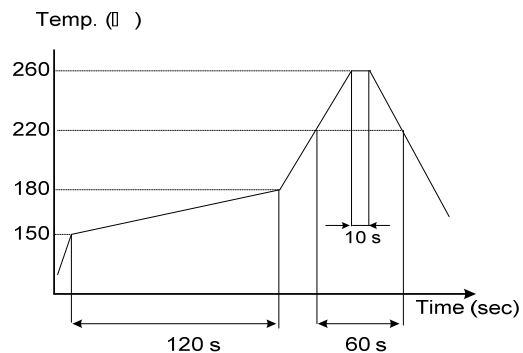

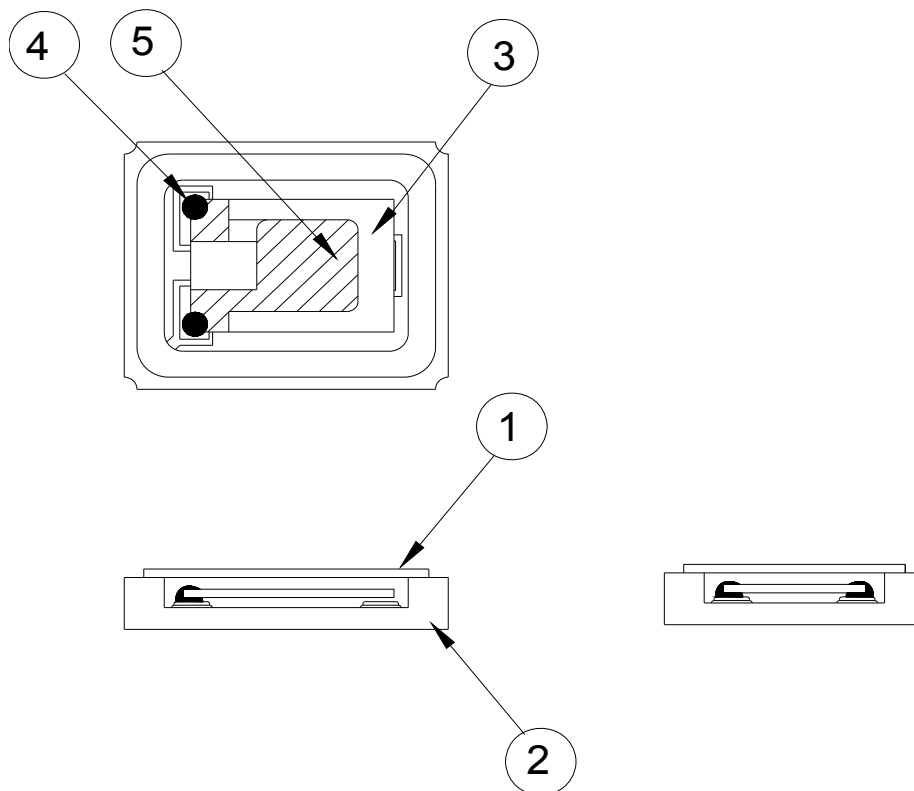
**■ STRUCTURE ILLUSTRATION**

NO	COMPONENTS	MATERIALS	FINISH/SPECIFICATIONS
1	Lid	Kovar	-
2	Base(Package)	Ceramic (Al <sub>2</sub> O <sub>3</sub> )+Pad(Au)	Alumina ceramics
3	Crystal blank	SiO <sub>2</sub>	-
4	Conductive adhesive	Ag	Silicone resin
5	Electrode	Noble Metal + Cr	-

■ PACKING

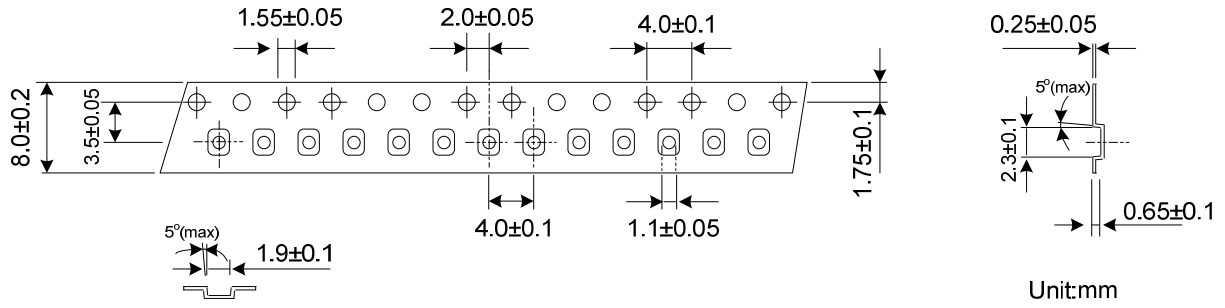

REMARK :

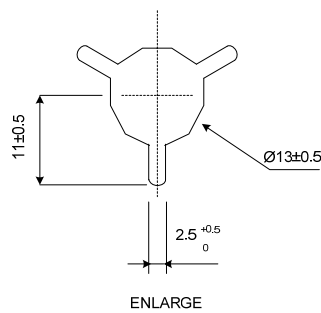
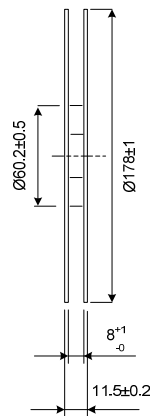
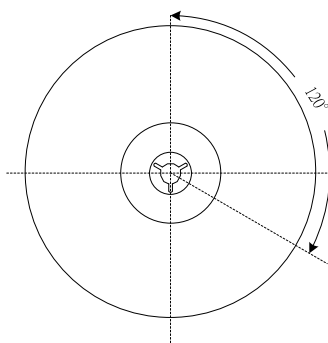
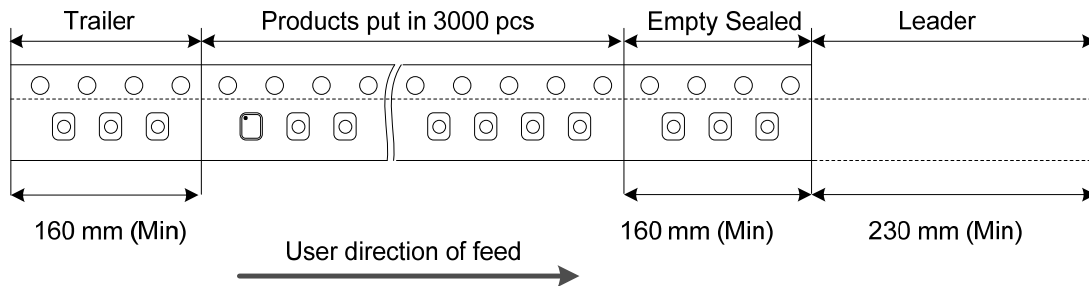

**RELIABILITY SPECIFICATIONS**

1. Mechanical Endurance

No.	Test Item	Test Methods	REF.DOC
1.1	Drop Test	150 cm height, 3 times on concrete floor.	JIS C6701
1.2	Mechanical Shock	Device are shocked to half sine wave ( 1000 G ) three mutually perpendicular axes each 3 times. 0.5m sec. duration time	MIL-STD-202
1.3	Vibration	Frequency range 10 ~ 2000 Hz Amplitude 1.52 mm/20G Sweep time 20 minutes perpendicular axes each test time 4 Hrs (Total test time 12 Hrs)	MIL-STD-883
1.4	Gross Leak	Standard Sample For Automatic Gross Leak Detector, Test Pressure: 2kg / cm <sup>2</sup>	MIL-STD-883
1.5	Fine Leak	Helium Bombing 4.5 kg/ cm <sup>2</sup> for 2 Hrs	
1.6	Solder ability	Temperature 245 °C ± 5°C Immersing depth 0.5 mm minimum Immersion time 5 ± 1 seconds Flux Rosin resin methyl alcohol solvent ( 1 : 4 )	MIL-STD-883

2. Environmental Endurance

No.	Test Item	Test Methods	REF. DOC
2.1	Resistance To Soldering Heat	Pre-heat temperature 125 °C Pre-heat time 60 ~ 120 sec. Test temperature 260 ± 5 °C Test time 10 ± 1 sec.	MIL-STD-202
2.2	High Temp. Storage	+ 125 °C ± 3 °C for 500 ± 12 Hrs	MIL-STD-883
2.3	Low Temp. Storage	- 40 °C ± 3 °C for 500 ± 12 Hrs	
2.4	Thermal Shock	Total 100 cycles of the following temperature cycle 	MIL-STD-883
2.5	High Temp & Humidity	85°C ± 3°C, RH 85% , 500 Hrs	EIA-JESD22