

SPECIFICATION FOR APPROVAL

CUSTOMER : _____

PRODUCT TYPE : SMD SEAM SEALING X'TAL 2.0 × 1.6

NOMINAL FREQ. : 24.000000MHz

TXC P/N : 8Y24000028

REVISION : S1

CUSTOMER P/N : _____

PM / SALES : _____

DATE : _____

CUSTOMER SIGNATURE & Date _____

- (1) TXC requires one copy returned with signature and title of authorized individual that signifies acceptance of the attached specifications.
- (2) Orders received and accepted by TXC after return of signed copy of specification will be produced per these specifications.
- (3) Any changes to these specifications must be agreed upon by both parties and new revision of the Product Specification Sheet will be issued.
- (4) Any issuance of purchase order prior to consigning back the Approval page of "Specification Sheets" from customers will be regarded as the agreement on the contents of these specifications.

Attachment: Product Specification Sheet

- 1
- 2
- 3
- 4
- 5

RoHS Compliant

PRODUCT SPECIFICATION SHEET

PRODUCT TYPE : SMD SEAM SEALING X'TAL 2.0 × 1.6

NOMINAL FREQ. : 24.000000MHz

TXC P/N : 8Y24000028

REVISION : S1

| PE/RD | QA | MFG |
|--|----|-----|
|  Robin Huang | | |
| 26-Jun-15 | | |

NOTE:

(1)The green product standard set by TXC is based upon the international standards. Related information is publicly described on the TXC's Website, and updated regularly. The document is compliant with the latest green product quality system directives at the time.

(2)Revision "Sx" is for engineering samples only. PE/RD's approval required.

(3)Revision "Ax" is production ready. PE, QA and MFG's approval required

RoHS Compliant

Spec Sheet Contents

| No. | Content | Page |
|-----|---|-------|
| 1 | ELECTRICAL SPECIFICATIONS | P.3 |
| 2 | DIMENSIONS | P.4 |
| 3 | MARKING | P.4 |
| 4 | FACTORY LOCATION | P.4 |
| 5 | SUGGESTED REFLOW PROFILE& MANUAL SOLDER CONDITION | P.4 |
| 6 | STRUCTURE ILLUSTRATION | P.5 |
| 7 | EMBOSS CARRIER TAPE & REEL | P.6 |
| 8 | PACKING | P.7 |
| 9 | RELIABILITY SPECIFICATIONS&HANDING CAUTIONS | P.8~9 |

■ ELECTRICAL SPECIFICATIONS

Standard atmospheric conditions

Unless otherwise specified, the standard range of atmospheric conditions for making measurement and tests are as follow:

Ambient temperature : $25 \pm 10^{\circ}\text{C}$
 Relative humidity : 40%~70%

If there is any doubt about the results, measurement shall be made within the following limits:

Ambient temperature : $25 \pm 3^{\circ}\text{C}$
 Relative humidity : 40%~70%

Measure equipment

Electrical characteristics measured by S&A250B or equivalent.

Crystal cutting type

The crystal is using AT CUT (thickness shear mode).

Unit Weight:

0.005±0.002 g/pcs

| | Parameters | Symbol | Electrical Spec. | | | | Notes |
|----|------------------------------|--------|------------------|------|------|-------|--|
| | | | Min. | Typ. | Max. | Units | |
| 1 | Nominal Frequency | FL | 24.000000 | | | MHz | - |
| 2 | Oscillation Mode | - | Fundamental | | | - | - |
| 3 | Load Capacitance | CL | 9 | | | pF | - |
| 4 | Frequency Tolerance | - | ±10 | | | ppm | at 25 °C ± 3 °C |
| 5 | Frequency Stability | - | ±15 | | | ppm | Over Operating Temp. Range (Reference 25°C) |
| 6 | Operating Temperature | - | -40 | ~ | 85 | °C | - |
| 7 | Aging | - | ±1 | | | ppm | 1st Year |
| 8 | Drive Level | DL | - | 100 | - | uW | - |
| 9 | Equivalent Series Resistance | Rr | - | - | 50 | Ω | - |
| 10 | Shunt Capacitance C0 | C0 | - | - | 3 | pF | - |
| 11 | Insulation Resistance | - | 500 | - | - | MΩ | at DC 100V |
| 12 | Storage Temperature Range | - | -40 | ~ | 85 | °C | - |

■ DIMENSIONS

(Unit:mm)

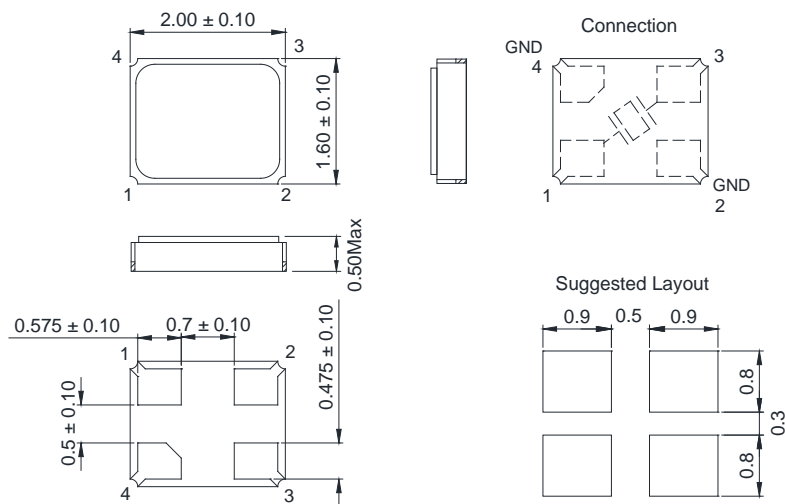

■ MARKING

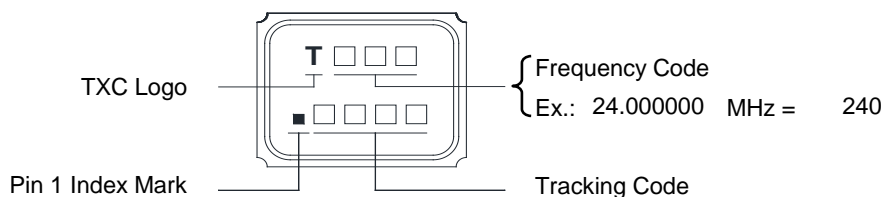

Production Location: Taiwan, China(Ningbo)

■ SUGGESTED REFLOW PROFIL

Total time : 200 sec. Max.

Solder melting point :220 °C

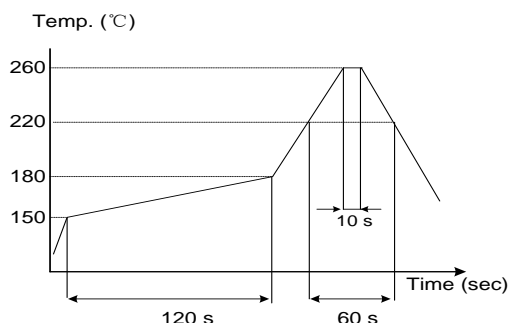

■ SUGGESTED MANUAL SOLDER CONDITION

Temperature: 350 ± 10 °C

Time: 3 sec.

Re-solder times: twice

■ STRUCTURE ILLUSTRATION

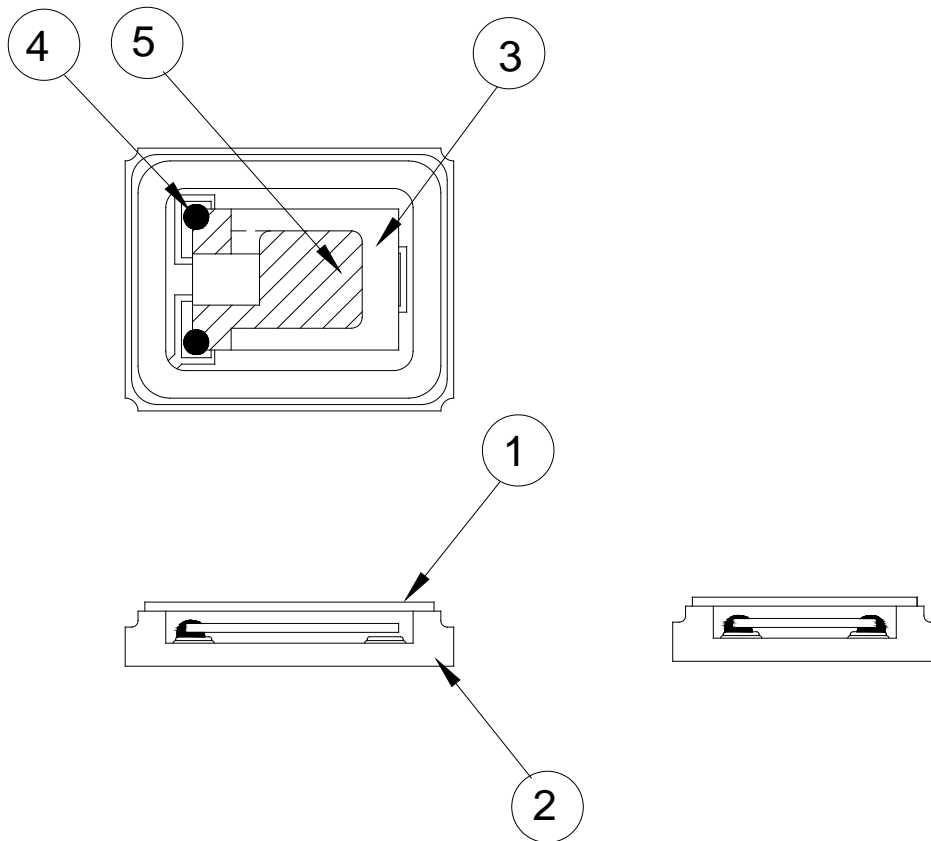

| NO | COMPONENTS | MATERIALS | FINISH/SPECIFICATIONS |
|----|---------------------|--|---|
| 1 | Lid | Kovar (Fe/Co/Ni) | - |
| 2 | Base(Package) | Ceramic (Al ₂ O ₃) + Kovar (Fe/Co/Ni)+Pad(Au) | Tungsten metalize + Ni plating + Au plating |
| 3 | Crystal blank | SiO ₂ | - |
| 4 | Conductive adhesive | Resin+Ag | - |
| 5 | Electrode | Noble Metal | - |

■ PACKING

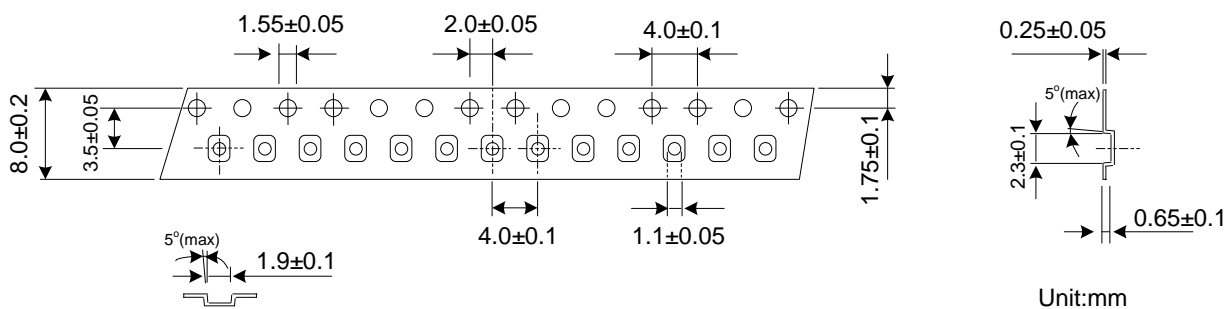

Unit:mm

REMARK :

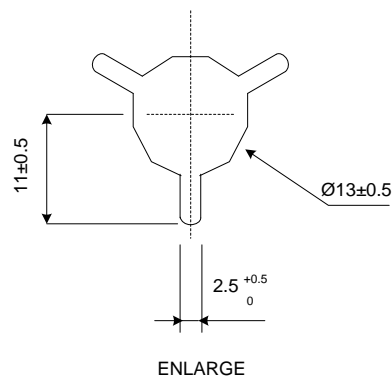
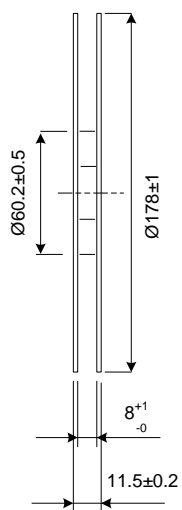
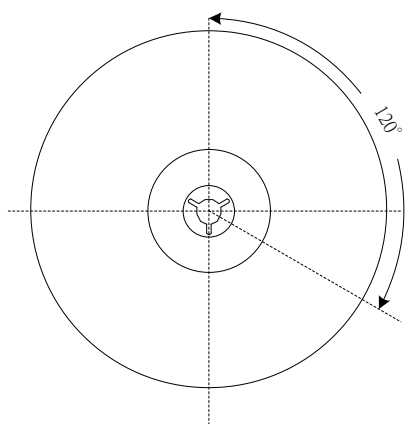
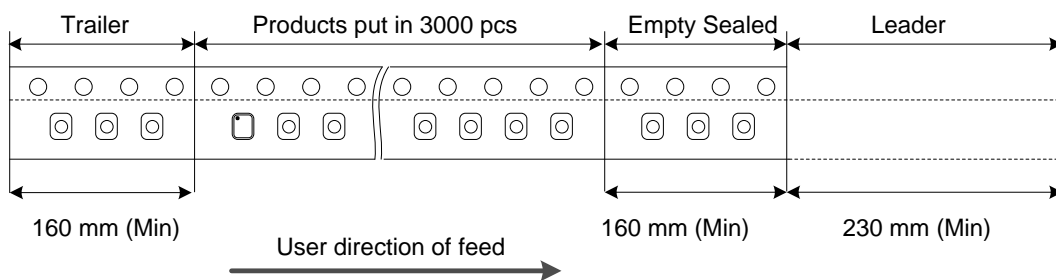

Standard Reel Quantity is 3,000 pcs per reel

PACKING

Reel Quantity :

- 1. Reel X 6 (6 Reels)
- 2. Reel X 12 (12 Reels)
- 3. Reel X 25 (12 Reels + 13 Reels)
- 4. Reel X 50 (12 Reelsx2 + 13 Reelsx2)

Box Size:

- 1. L200 X W200 X H140mm
- 2. L200 X W200 X H250mm
- 3. L400 X W200 X H250mm
- 4. L400 X W400 X H280mm

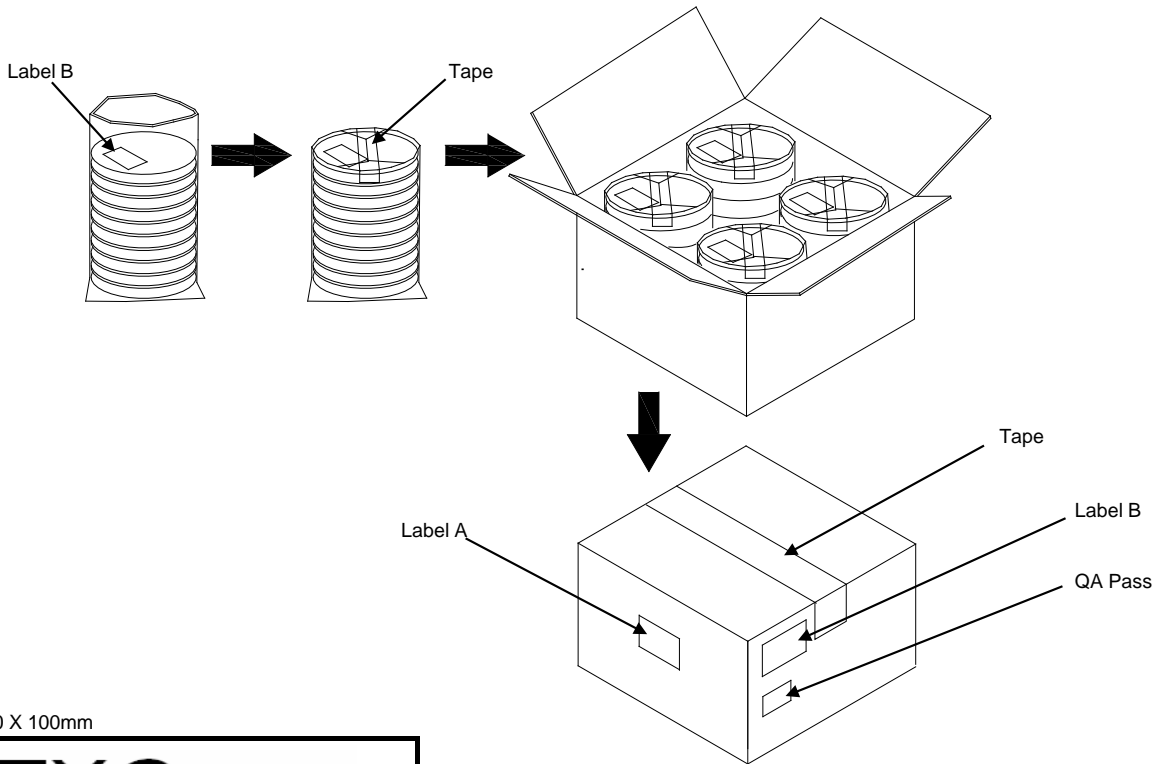

(Label A) Size:100 X 100mm

| | |
|--------------|------------|
| <h1>TXC</h1> | |
| Inv No: | □□□□□□□□ □ |
| Po No: | □□□□□□□□ □ |
| Part No: | □□□□□□□□ □ |
| Q'ty: | □□□□ PCS |
| C/No: | □□□□ |

(Label B) Size:80 X 40mm

| | | |
|---------------------|-------------|------------|
| TXC CORPORATION | | QA PASS |
| DATE CODE: □□□□□□□□ | QTY: □□□□ | 2011/09/02 |
| LOT NO: □□□□□□□□ | RoHS | |
| PART NO: □□□□□□□□ | HF | |
| FREQ: □□□□□□□□□□ | | |

[STORAGE]

- 1. The storage time to be 1 year maximum.
- 2. Don't be caught in the rain.
- 3. The storage environment shall be 5°C ~40°C temperature and 30% ~ 75%RH humidity and free from the sun shine.
- 4. If customers have special requirements, we can paste labels according to it.

■ RELIABILITY SPECIFICATIONS

1. Mechanical Endurance

| No. | Test Item | Test Methods | Test Criteria |
|-----|------------------|---|---------------|
| 1 | Drop Test | 150 cm height, 3 times on concrete floor. | A . C |
| 1 | Mechanical Shock | Device are shocked to half sine wave (1000 G) three mutually perpendicular axes each 3 times. 0.5m sec. duration time | A . C |
| 1 | Vibration | Frequency range 10 ~ 2000 Hz Amplitude 1.52 mm/20G Sweep time 20 minutes perpendicular axes each test time 4 Hrs (Total test time 12 Hrs) | A . C |
| 1 | Gross Leak | Standard Sample For Automatic Gross Leak Detector, Test Pressure: 2kg / cm ² | F |
| 2 | Fine Leak | Helium Bombing 4.5 kg/ cm ² for 2 Hrs | G |
| 2 | Solder ability | Temperature 240 °C ± 5°C Immersing depth 0.5 mm minimum Immersion time 5 ± 1 seconds Flux Rosin resin methyl alcohol solvent (1 : 4) | E |

2. Environmental Endurance

| No. | Test Item | Test Methods | Test Criteria |
|-----|------------------------------|--|---------------|
| 2 | Resistance To Soldering Heat | Pre-heat temperature 125 °C Pre-heat time 60 ~ 120 sec. Test temperature 260 ± 5 °C Test time 10 ± 1 sec. | B . C . D |
| 2 | High Temp. Storage | + 125 °C ± 3 °C for 500 ± 12 Hrs | B . C . D |
| 2 | Low Temp. Storage | - 40 °C ± 3 °C for 500 ± 12 Hrs | |
| 2 | Temperature cycle | Total 100 cycles of the following temperature cycle | B . C . D |
| 3 | High Temp & Humidity | 85°C ± 3°C, RH 85% , 500Hrs | B . C . D |

RELIABILITY SPECIFICATIONS

| Specifications | |
|----------------|---|
| A | Frequency change: Within ± 5 ppm or in customer's specification. |
| B | Frequency change: Within ± 10 ppm or in customer's specification. |
| C | Equivalent series resistance(E.S.R) change: Within $\pm 15\%$ or 10Ω (larger value). |
| D | After conditioning , quartz crystal units shall be subjected to standard atmospheric conditions for 2 hour, and measured. |
| E | Minimum 95% of immersed terminal shall be covered with new uniform solder. |
| F | Leak rate $< 1 \times 10^{-5}$ Pa*m ³ /Sec |
| G | Leak rate $< 4 \times 10^{-9}$ Pa*m ³ /Sec |

Measurement condition

Electrical characteristics measured by S&A250B or equivalent.