

## 30V N-Channel Trench MOSFET

### FEATURES

- Super Low Gate Charge
- 100% EAS Guaranteed
- RoHS compliant
- Green Device Available
- Excellent CdV/dt effect decline
- Advanced high cell density Trench technology

### APPLICATIONS

- Switch Mode Power Supply (SMPS)
- Uninterruptible Power Supply (UPS)
- Hard switched and high frequency circuits

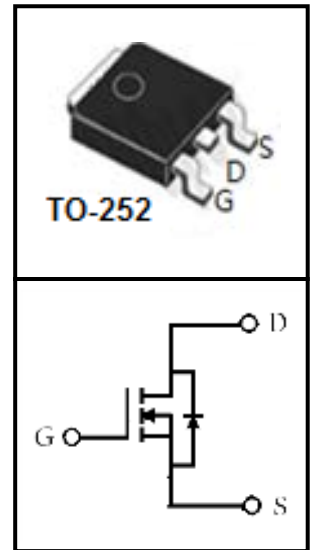

### Device Marking and Package Information

Device	Package	Marking
CTD03N3P3	TO-252	CTD03N3P3

### Absolute Maximum Ratings at $T_j = 25^\circ\text{C}$ unless otherwise noted

Parameter	Symbol	Value	Unit
Drain-Source Voltage ( $V_{GS} = 0\text{V}$ )	$V_{DSS}$	30	V
Continuous Drain Current $T_C = 25^\circ\text{C}$ (note1)	$I_D$	150	A
Continuous Drain Current $T_C = 100^\circ\text{C}$ (note1)		110	A
Pulsed Drain Current (note2)	$I_{DM}$	440	A
Gate Source Voltage	$V_{GSS}$	$\pm 20$	V
Single Pulse Avalanche Energy (note3)	$E_{AS}$	870	mJ
Power Dissipation $T_C = 25^\circ\text{C}$ (note4)	$P_D$	107	W
Operating Junction and Storage Temperature Range	$T_J, T_{stg}$	-55~175	$^\circ\text{C}$

### Thermal Characteristics

Parameter	Symbol	Value	Unit
Thermal Resistance, Junction-Case (note1)	$R_{\theta JC}$	1.4	$^\circ\text{C}/\text{W}$
Thermal Resistance, Junction-Ambient ( $t \leq 10\text{S}$ ) (note1)	$R_{\theta JA}$	62.5	$^\circ\text{C}/\text{W}$

Electrical Characteristics $T_J = 25^\circ\text{C}$ unless otherwise specified						
Parameter	Symbol	Test Conditions	Value			Unit
			Min.	Typ.	Max.	
<b>Static</b>						
Drain-Source Breakdown Voltage	$V_{(BR)DSS}$	$V_{GS} = 0V, I_D = 250\mu A$	30	--	--	V
Zero Gate Voltage Drain Current	$I_{DSS}$	$V_{DS} = 24V, V_{GS} = 0V, T_J = 25^\circ\text{C}$	--	--	1	$\mu A$
		$V_{DS} = 24V, V_{GS} = 0V, T_J = 100^\circ\text{C}$	--	--	5	$\mu A$
Gate-Source Leakage	$I_{GSS}$	$V_{GS} = \pm 20V$	--	--	$\pm 100$	nA
Gate-Source Threshold Voltage	$V_{GS(th)}$	$V_{DS} = V_{GS}, I_D = 250\mu A$	1.0	1.6	3.0	V
Drain-Source On-Resistance (note2)	$R_{DS(on)}$	$V_{GS} = 10V, I_D = 30A$	--	2.0	3.3	$m\Omega$
		$V_{GS} = 4.5V, I_D = 20A$	--	4.0	6.0	$m\Omega$
<b>Dynamic</b>						
Input Capacitance	$C_{iss}$	$V_{GS} = 0V,$ $V_{DS} = 15V,$ $f = 1.0MHz$	--	5378	--	pF
Output Capacitance	$C_{oss}$		--	911	--	
Reverse Transfer Capacitance	$C_{rss}$		--	250	--	
Total Gate Charge	$Q_g$	$V_{DS} = 25V, I_D = 14A,$ $V_{GS} = 10V$	--	98	--	nC
Gate-Source Charge	$Q_{gs}$		--	10	--	
Gate-Drain Charge	$Q_{gd}$		--	26	--	
Turn-on Delay Time	$t_{d(on)}$	$V_{DS} = 15V,$ $V_{GS} = 10V, R_G = 3\Omega$	--	22	--	ns
Turn-on Rise Time	$t_r$		--	44	--	
Turn-off Delay Time	$t_{d(off)}$		--	83	--	
Turn-off Fall Time	$t_f$		--	18	--	
<b>Body Diode Characteristics</b>						
Continuous Body Diode Current	$I_S$	$T_C = 25^\circ\text{C}$	--	--	150	A
Pulsed Diode Forward Current	$I_{SM}$		--	--	440	
Body Diode Voltage	$V_{SD}$	$T_J = 25^\circ\text{C}, I_{SD} = 20A, V_{GS} = 0V$	--	--	1.2	V
Reverse Recovery Time	$t_{rr}$	$T_J = 25^\circ\text{C}, I_F = 20A,$ $di/dt = 100A/\mu s$	--	25	--	nS
Reverse Recovery Charge	$Q_{rr}$		--	15	--	nc

**Notes**

1. The data tested by surface mounted on a 1 inch<sup>2</sup> FR-4 board with 2OZ copper.
2. The data tested by pulsed , pulse width $\leq 300\mu s$  , duty cycle $\leq 2\%$
3. The EAS data shows Max. rating . The test condition is  $V_{DD} = 25V, V_{GS} = 10V, L = 0.1mH$
4. The power dissipation is limited by 175 $^\circ\text{C}$  junction temperature
5. The data is theoretically the same as ID and IDM , in real applications , should be limited by total power dissipation.

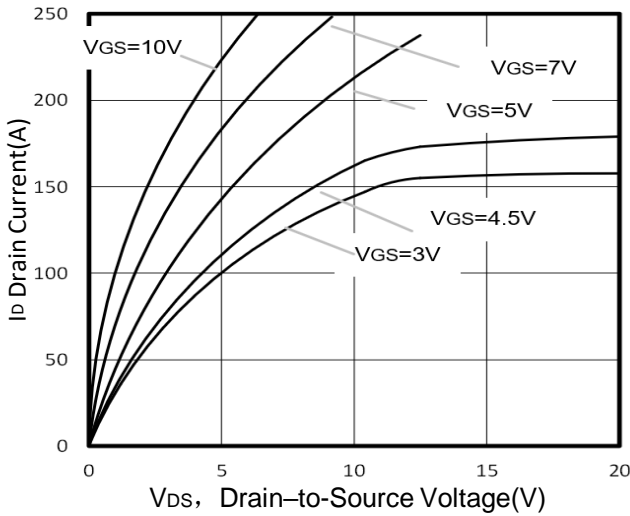
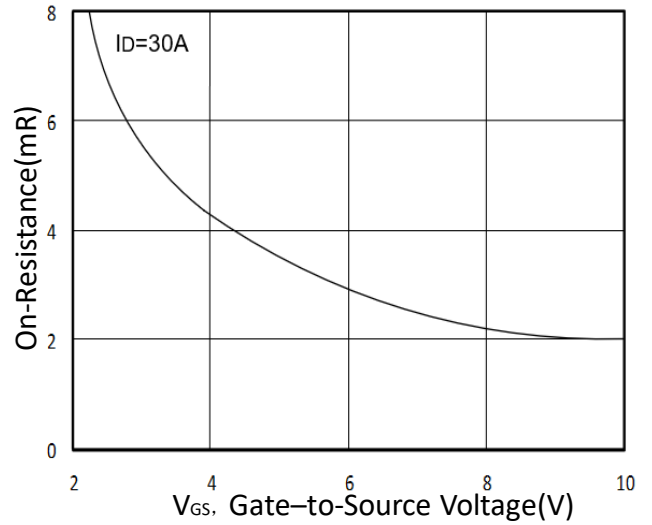
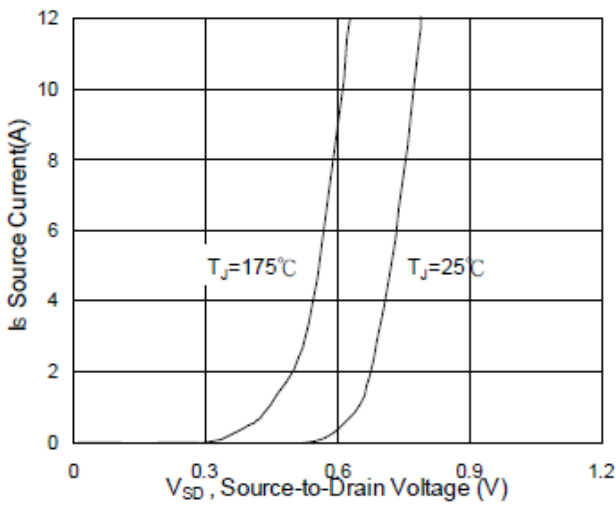
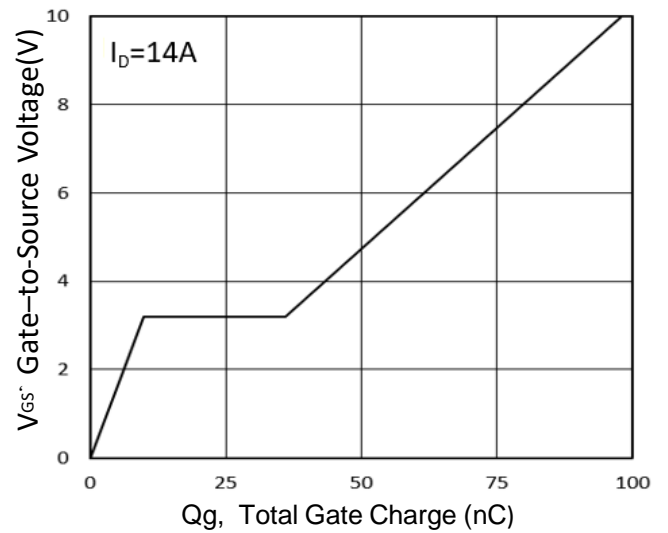
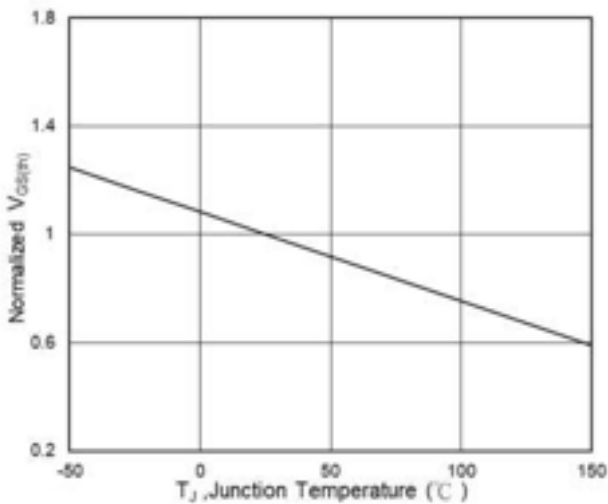
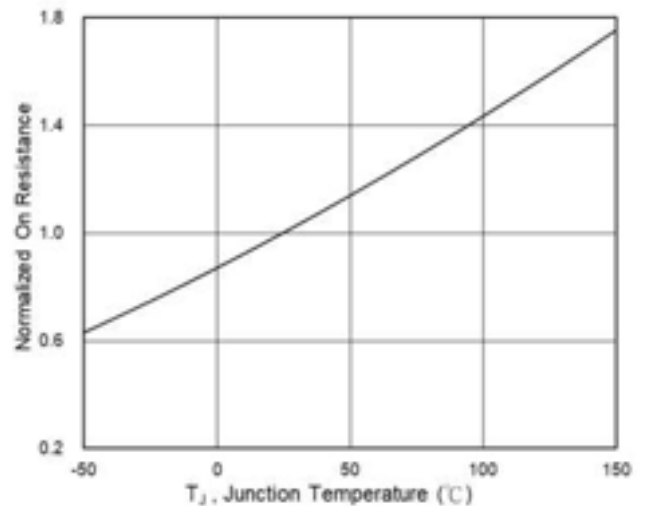
**Typical Characteristics**  $T_J = 25^\circ\text{C}$ , unless otherwise noted

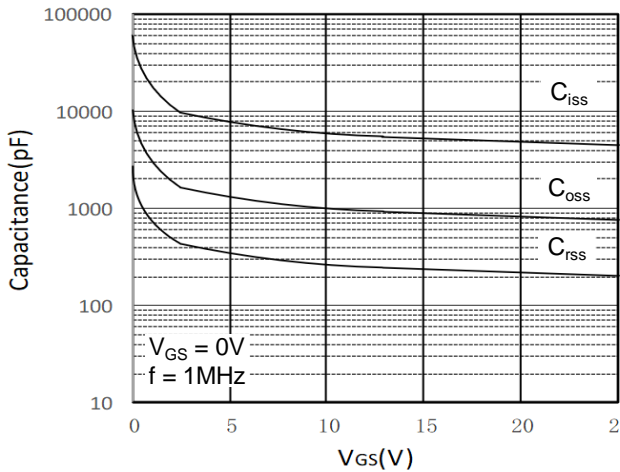
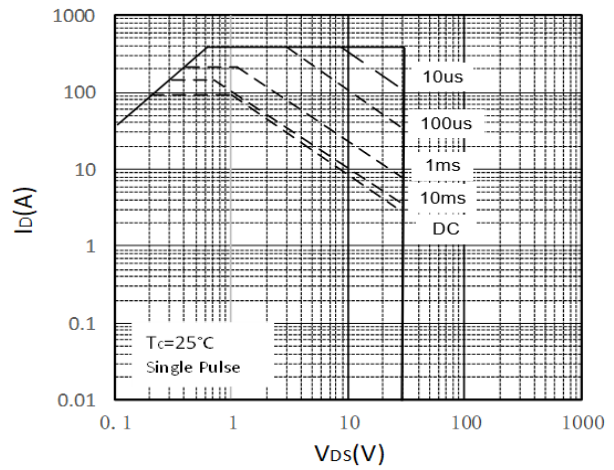
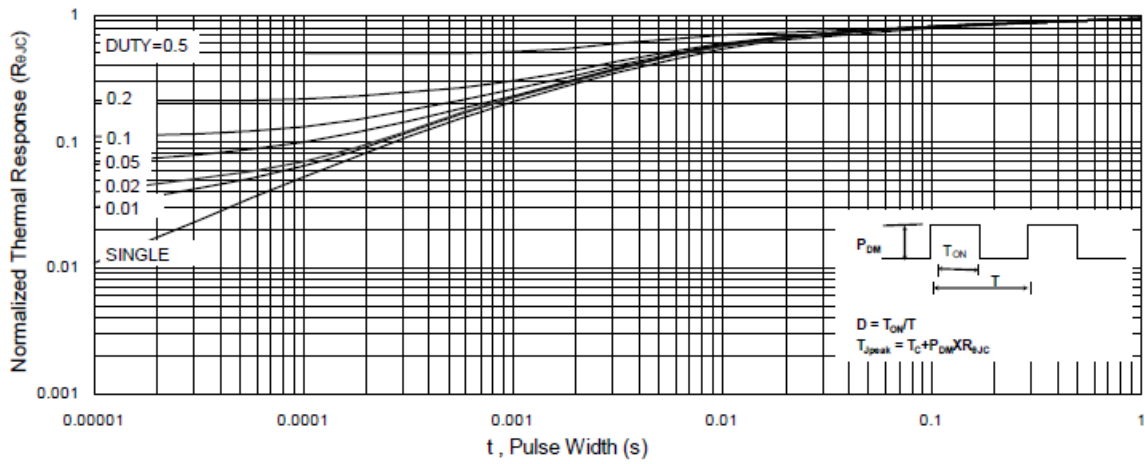
**Fig.1 Typical Output Characteristics**

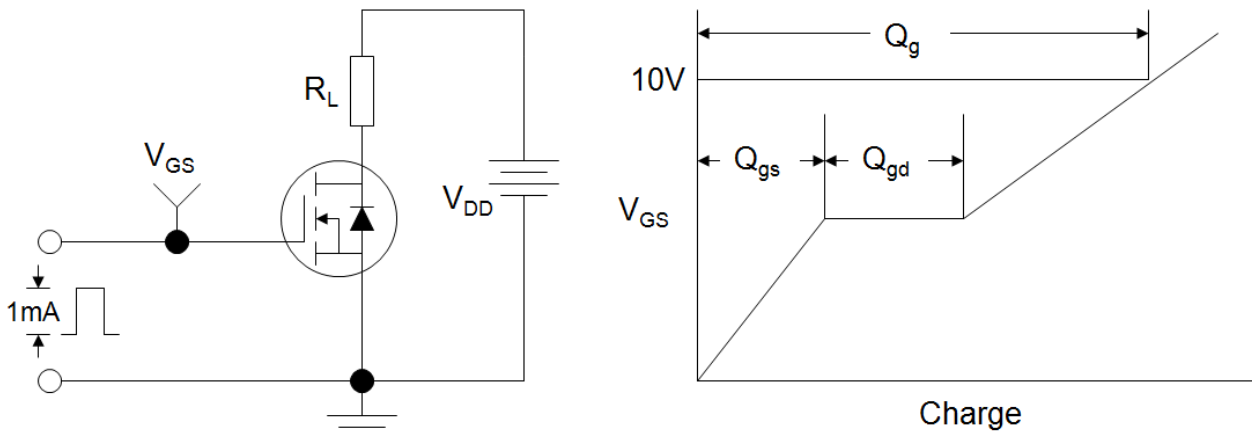
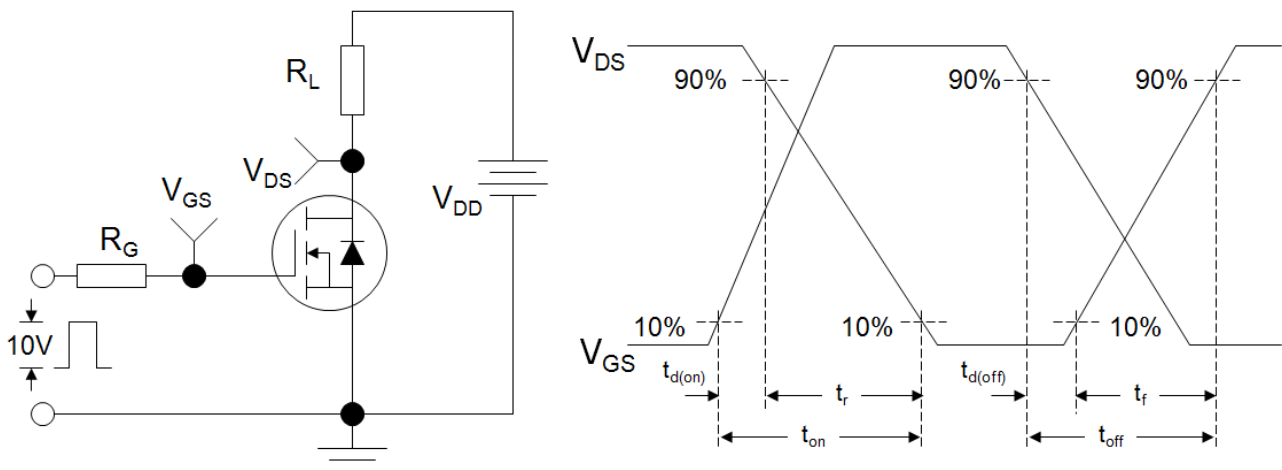
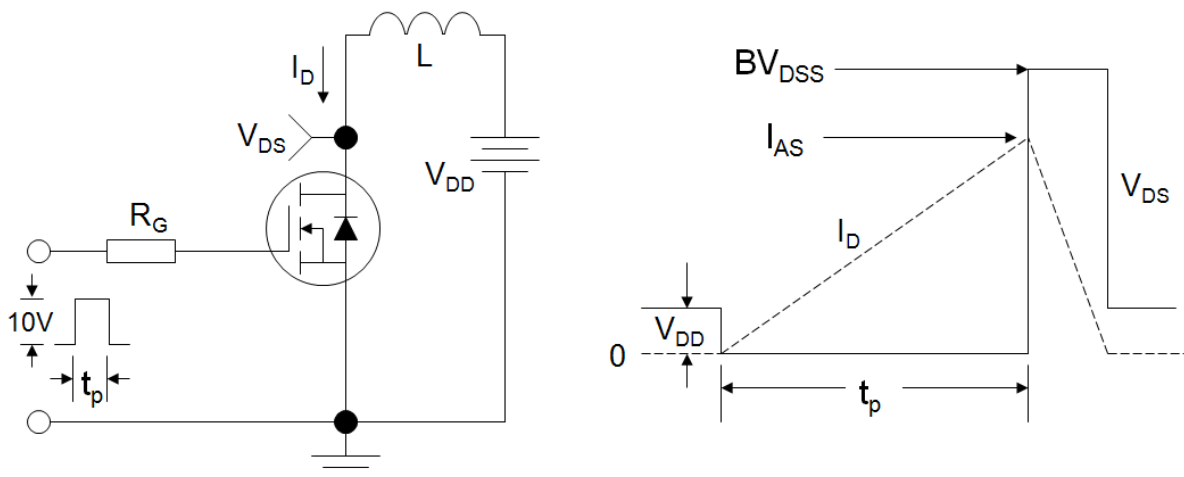
**Fig.2 On-Resistance vs. G-S Voltage**

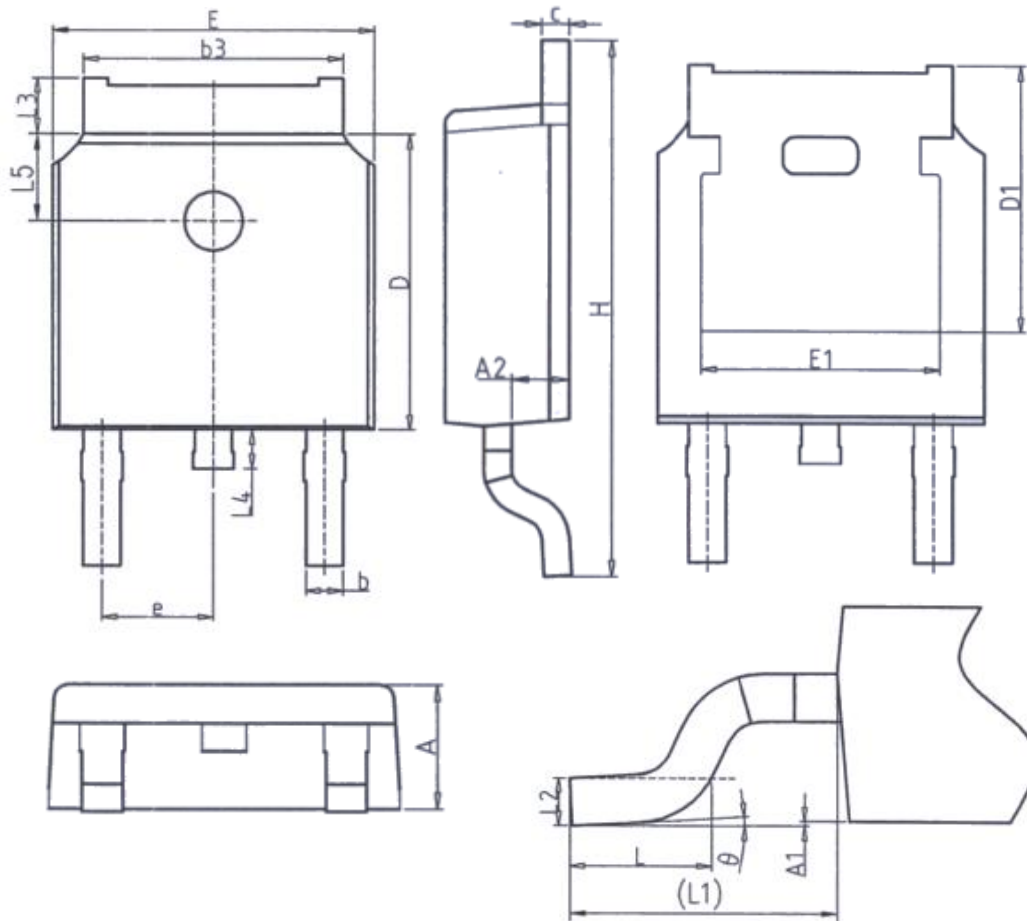
**Fig.3 Forward Characteristics of Reverse Diode**

**Fig.4 Gate-Charge Characteristics**

**Fig.5 Normalized  $V_{GS(th)}$  v.s  $T_J$** 

**Fig.6 Normalized  $R_{DS(on)}$  v.s  $T_J$**

**Typical Characteristics**  $T_J = 25^\circ\text{C}$ , unless otherwise noted

**Fig.7 Capacitance**

**Fig.8 Safe Operating Area**

**Fig.9 Normalized Maximum Transient Thermal Impedance**

**Figure A: Gate Charge Test Circuit and Waveform**

**Figure B: Resistive Switching Test Circuit and Waveform**

**Figure C: Unclamped Inductive Switching Test Circuit and Waveform**

**TO-252**

Unit: mm		
Symbol	Min.	Max.
A	2.20	2.40
A1	0.00	0.20
A2	0.97	1.17
b	0.68	0.90
b3	5.20	5.50
c	0.43	0.63
D	5.98	6.22
D1	5.30REF	
E	6.40	6.80
E1	4.63	-

Unit: mm		
Symbol	Min.	Max.
e	2.286BSC	
H	9.40	10.50
L	1.38	1.75
L1	2.90REF	
L2	0.51BSC	
L3	0.88	1.28
L4	-	1.00
L5	1.65	1.95
$\theta$	0°	8°

---

## Disclaimer

All product specifications and data are subject to change without notice.

For documents and material available from this datasheet, Suzhou Convert does not warrant or assume any legal liability or responsibility for the accuracy, completeness of any product or technology disclosed hereunder.

No license, express or implied, by estoppels or otherwise, to any intellectual property rights is granted by this document or by any conduct of Suzhou Convert.

The products shown herein are not designed for use in medical, life-saving, or life-sustaining applications unless. Customers using or selling Suzhou Convert products not expressly indicated for use in such applications do so entirely at their own risk and agree to fully indemnify Suzhou Convert for any damages arising or resulting from such use or sale.

Suzhou Convert disclaims any and all liability arising out of the use or application of any product described herein or of any information provided herein to the maximum extent permitted by law. The product specifications do not expand or otherwise modify Suzhou Convert's terms and conditions of purchase, including but not limited to the warranty expressed therein, which apply to these products.

Suzhou Convert Semiconductor CO., Ltd. strives to supply high-quality high-reliability products. However, any and all semiconductor products fail with some probability. It is possible that these probabilistic failures could give rise to accidents or events that could endanger human lives that could give rise to smoke or fire, or that could cause damage to other property. When designing equipment, adopt safety measures so that these kinds of accidents or events cannot occur. Such measures include but are not limited to protective circuits and error prevention circuits for safe design, redundant design, and structural design.

In the event that any or all Suzhou Convert products(including technical data, services) described or contained herein are controlled under any of applicable local export control laws and regulations, such products must not be exported without obtaining the export license from the authorities concerned in accordance with the above law.

Information (including circuit diagrams and circuit parameters) herein is for example only; it is not guaranteed for volume production. Suzhou Convert believes information herein is accurate and reliable, but no guarantees are made or implied regarding its use or any infringements of intellectual property rights or other rights of third parties.