

30V N-Channel Trench MOSFET

FEATURES

- Super Low Gate Charge
- 100% EAS Guaranteed
- RoHS compliant
- Green Device Available
- Excellent CdV/dt effect decline
- Advanced high cell density Trench technology

APPLICATIONS

- Switch Mode Power Supply (SMPS)
- Uninterruptible Power Supply (UPS)
- Hard switched and high frequency circuits

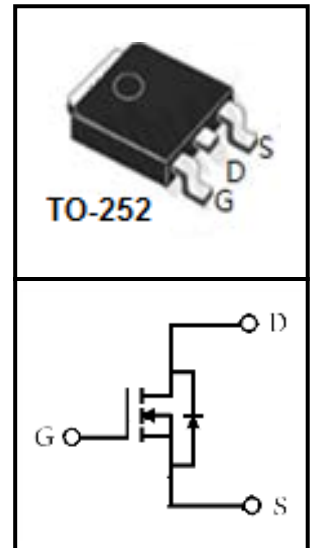

Device Marking and Package Information

Device	Package	Marking
CTD03N003	TO-252	CTD03N003

Absolute Maximum Ratings at $T_j = 25^{\circ}\text{C}$ unless otherwise noted

Parameter	Symbol	Value	Unit
Drain-Source Voltage ($V_{GS} = 0\text{V}$)	V_{DSS}	30	V
Continuous Drain Current $T_C = 25^{\circ}\text{C}$ (note1)	I_D	180	A
Continuous Drain Current $T_C = 100^{\circ}\text{C}$ (note1)		120	A
Pulsed Drain Current (note2)	I_{DM}	380	A
Gate Source Voltage	V_{GSS}	± 20	V
Single Pulse Avalanche Energy (note3)	E_{AS}	267	mJ
Power Dissipation $T_C = 25^{\circ}\text{C}$ (note4)	P_D	90	W
Operating Junction and Storage Temperature Range	T_J, T_{stg}	-55~+175	$^{\circ}\text{C}$

Thermal Characteristics

Parameter	Symbol	Value	Unit
Thermal Resistance, Junction-Case (note1)	$R_{\theta JC}$	1.4	$^{\circ}\text{C}/\text{W}$
Thermal Resistance, Junction-Ambient ($t \leq 10\text{S}$) (note1)	$R_{\theta JA}$	25	$^{\circ}\text{C}/\text{W}$
Thermal Resistance Junction-ambient (Steady State)	$R_{\theta JA}$	62	$^{\circ}\text{C}/\text{W}$

Electrical Characteristics $T_J = 25^\circ\text{C}$ unless otherwise specified						
Parameter	Symbol	Test Conditions	Value			Unit
			Min.	Typ.	Max.	
Static						
Drain-Source Breakdown Voltage	$V_{(BR)DSS}$	$V_{GS} = 0V, I_D = 250\mu A$	30	--	--	V
Zero Gate Voltage Drain Current	I_{DSS}	$V_{DS} = 24V, V_{GS} = 0V, T_J = 25^\circ\text{C}$	--	--	1	μA
		$V_{DS} = 24V, V_{GS} = 0V, T_J = 55^\circ\text{C}$	--	--	5	μA
Gate-Source Leakage	I_{GSS}	$V_{GS} = \pm 20V$	--	--	± 100	nA
Gate-Source Threshold Voltage	$V_{GS(th)}$	$V_{DS} = V_{GS}, I_D = 250\mu A$	1.0	1.5	2.5	V
Drain-Source On-Resistance (note2)	$R_{DS(on)}$	$V_{GS} = 10V, I_D = 30A$	--	2.3	3	m Ω
		$V_{GS} = 4.5V, I_D = 15A$	--	3.0	4	m Ω
Dynamic						
Input Capacitance	C_{iss}	$V_{GS} = 0V,$ $V_{DS} = 15V,$ $f = 1.0\text{MHz}$	--	5935	--	pF
Output Capacitance	C_{oss}		--	725	--	
Reverse Transfer Capacitance	C_{rss}		--	538	--	
Total Gate Charge (4.5V)	Q_g	$V_{DS} = 15V, I_D = 15A,$ $V_{GS} = 4.5V$	--	56.9	--	nC
Gate-Source Charge	Q_{gs}		--	13.8	--	
Gate-Drain Charge	Q_{gd}		--	23.5	--	
Turn-on Delay Time	$t_{d(on)}$	$V_{DS} = 15V,$ $V_{GS} = 10V, R_G = 3.3\Omega$ $I_D = 15A$	--	20.1	--	ns
Turn-on Rise Time	t_r		--	6.3	--	
Turn-off Delay Time	$t_{d(off)}$		--	124.6	--	
Turn-off Fall Time	t_f		--	15.8	--	
Body Diode Characteristics						
Continuous Body Diode Current	I_S	$T_C = 25^\circ\text{C}$	--	--	180	A
Pulsed Diode Forward Current	I_{SM}		--	--	380	
Body Diode Voltage	V_{SD}	$T_J = 25^\circ\text{C}, I_{SD} = 5A, V_{GS} = 0V$	--	--	1.2	V
Reverse Recovery Time	t_{rr}	$T_J = 25^\circ\text{C}, I_F = 30A,$ $di/dt = 100A/\mu s$	--	25	--	nS
Reverse Recovery Charge	Q_{rr}		--	12	--	nc

Notes

1. The data tested by surface mounted on a 1 inch² FR-4 board with 2OZ copper.
2. The data tested by pulsed , pulse width $\leq 300\mu s$, duty cycle $\leq 2\%$
3. The EAS data shows Max. rating . The test condition is $V_{DD} = 25V, V_{GS} = 10V, L = 0.1\text{mH}$
4. The power dissipation is limited by 175 $^\circ\text{C}$ junction temperature
5. The data is theoretically the same as ID and IDM , in real applications , should be limited by total power dissipation.

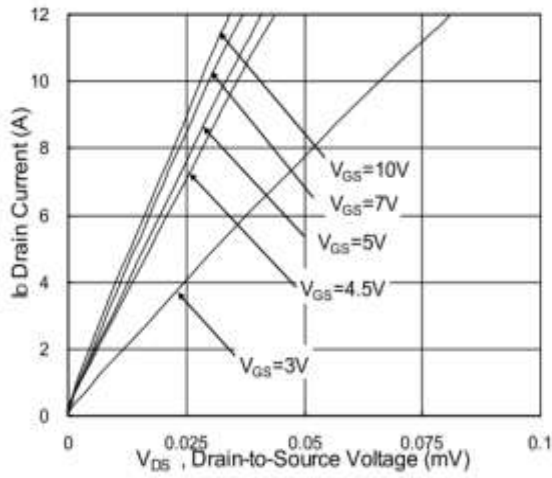
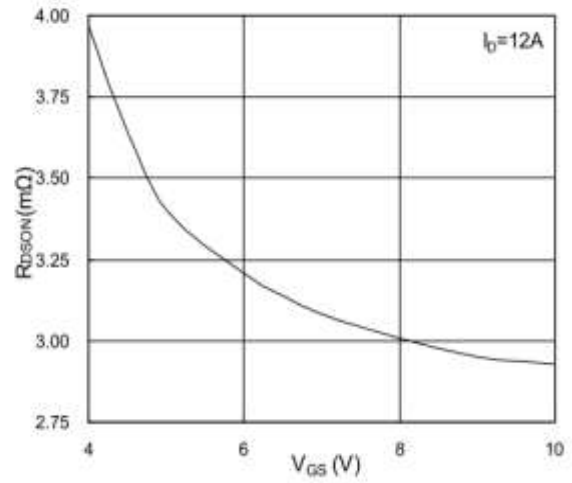
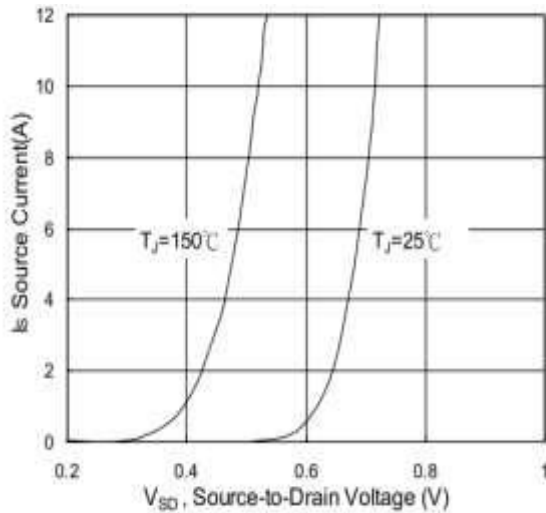
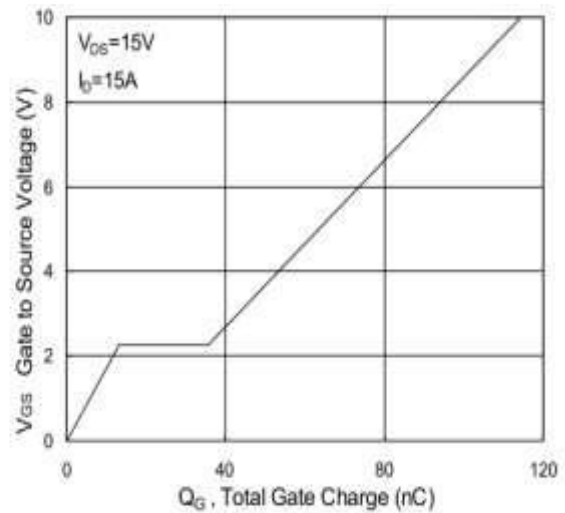
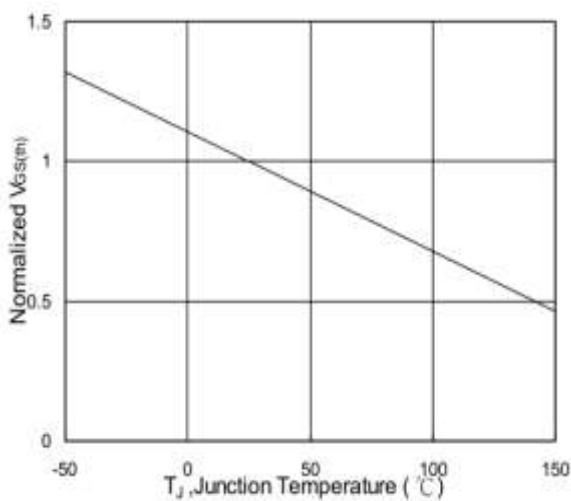
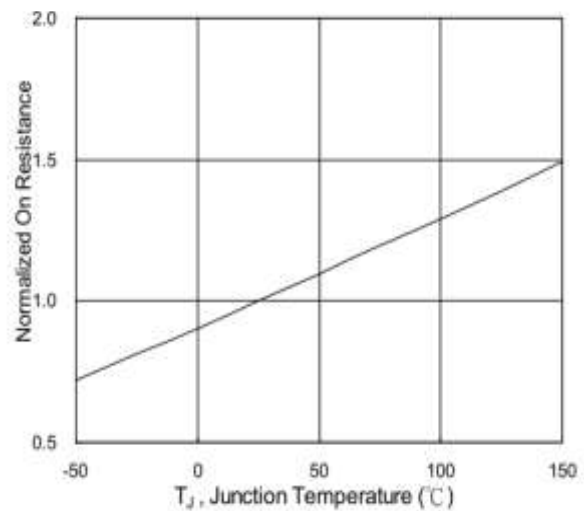
Typical Characteristics $T_J = 25^\circ\text{C}$, unless otherwise noted

Fig.1 Typical Output Characteristics

Fig.2 On-Resistance vs. G-S Voltage

Fig.3 Forward Characteristics of Reverse Diode

Fig.4 Gate-Charge Characteristics

Fig.5 Normalized VGS(th) vs. TJ

Fig.6 Normalized RDSON vs. TJ

Typical Characteristics $T_{j1} = 25^{\circ}\text{C}$, unless otherwise noted

Fig.7 Capacitance

Fig.8 Safe Operating Area

Fig.9 Normalized Maximum Transient Thermal Impedance

Figure A: Gate Charge Test Circuit and Waveform

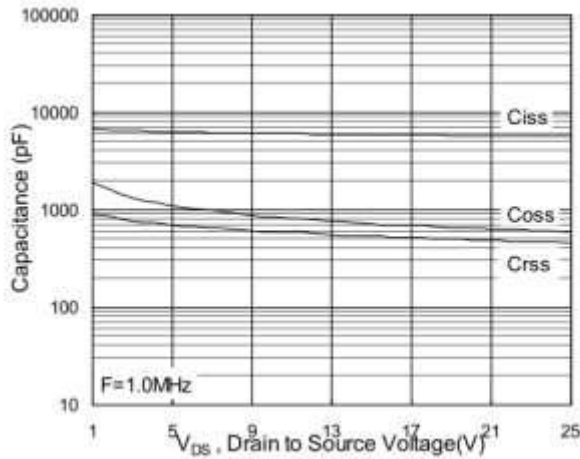
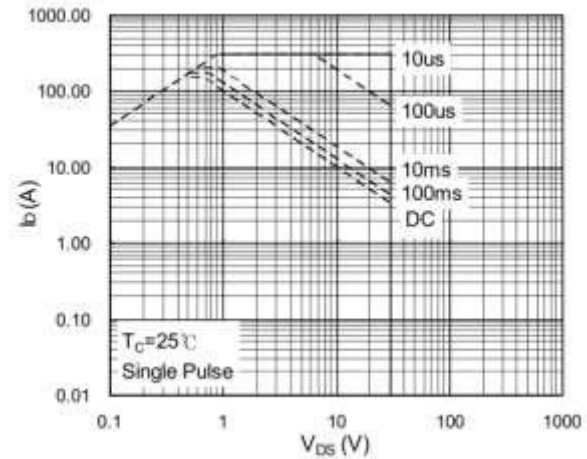
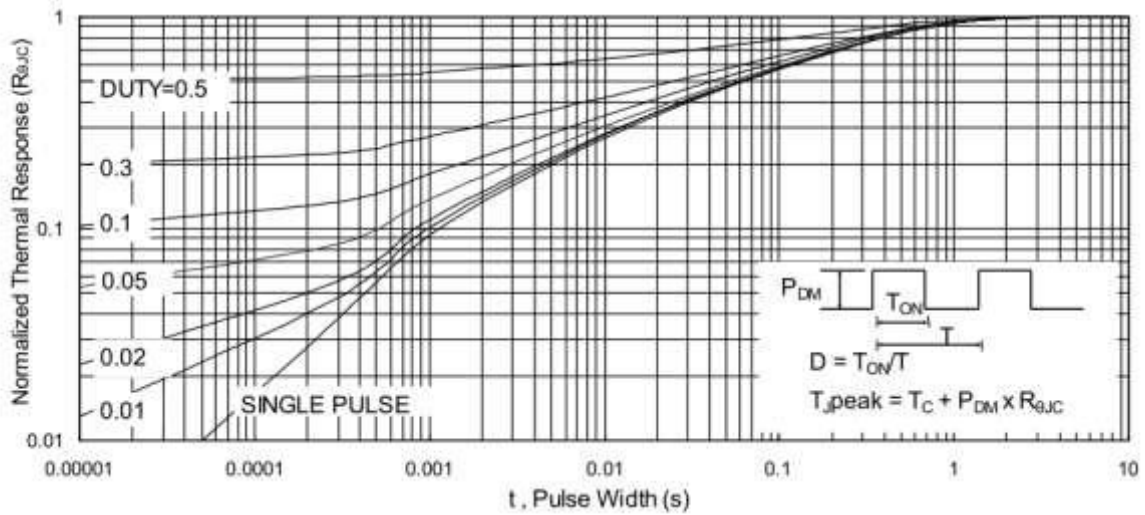
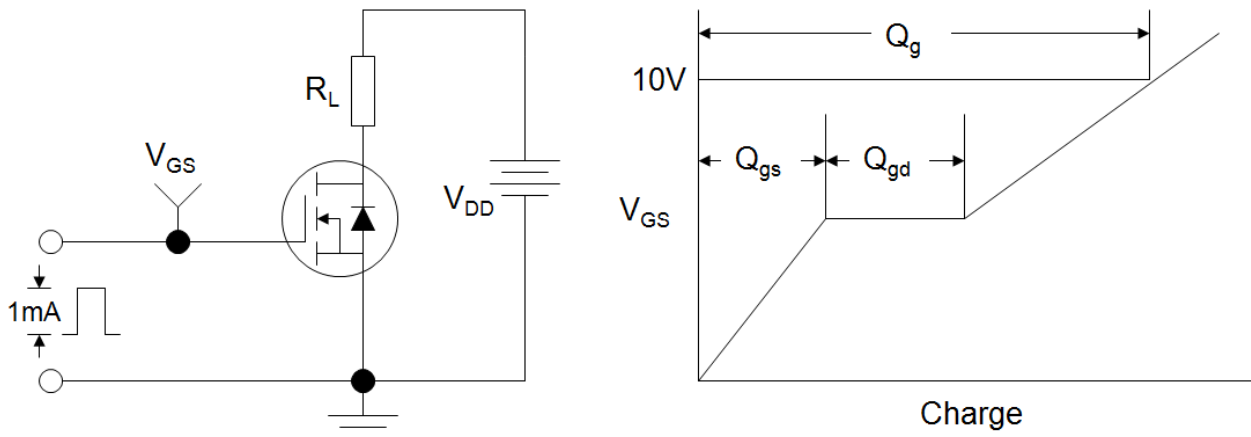
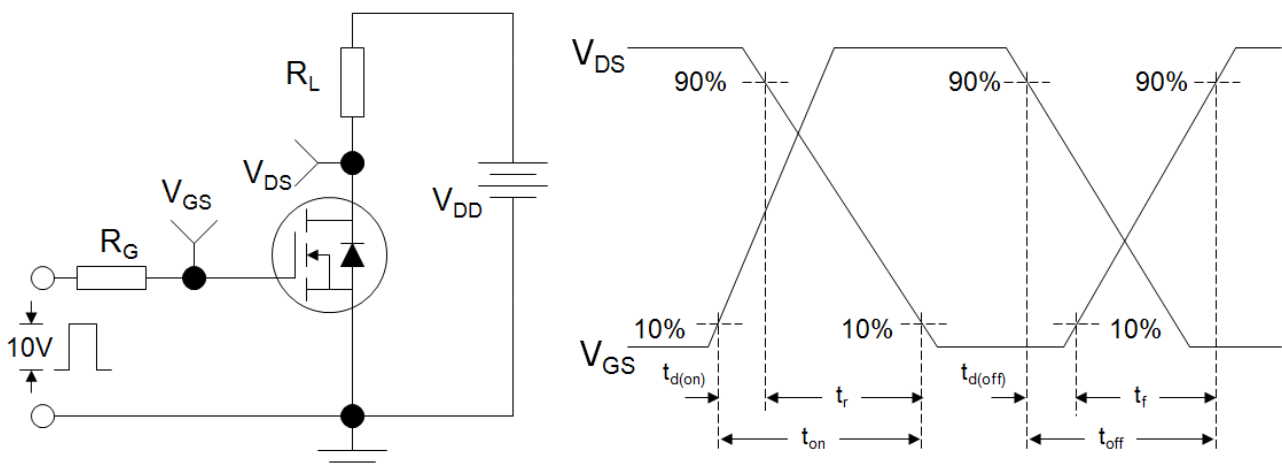
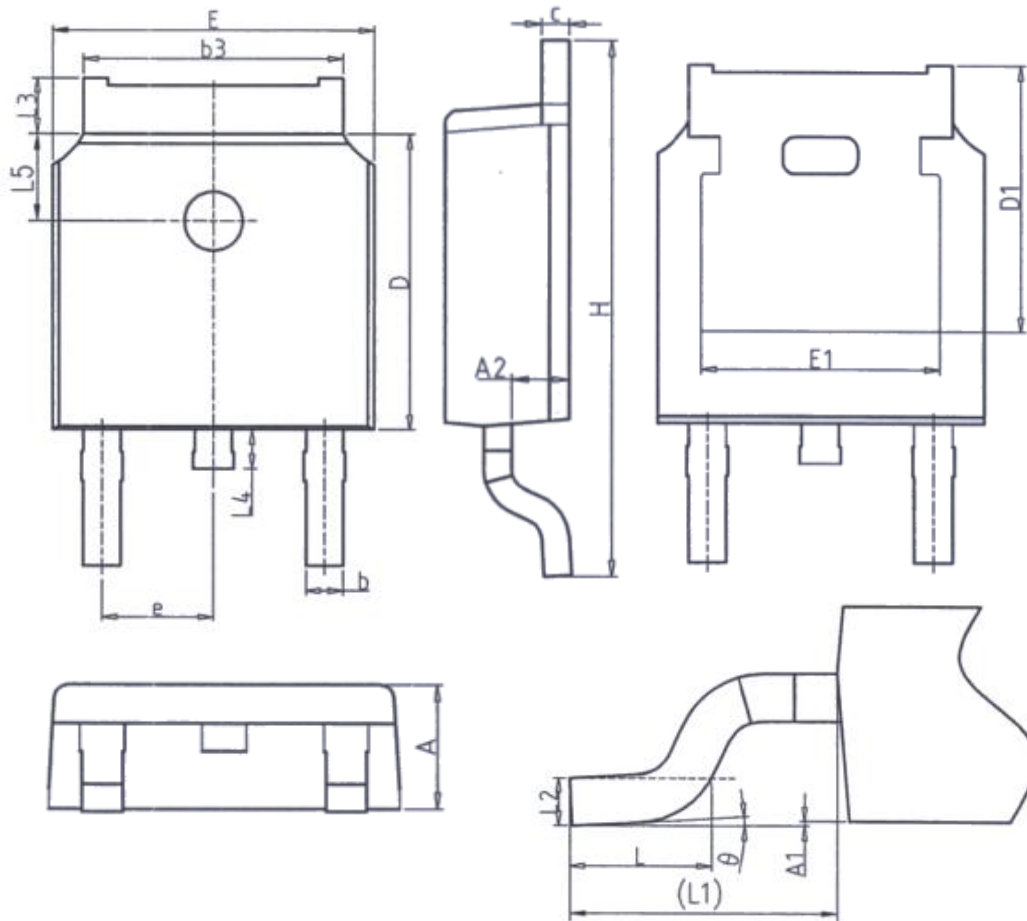
Figure B: Resistive Switching Test Circuit and Waveform

Figure C: Unclamped Inductive Switching Test Circuit and Waveform

TO-252



Unit: mm		
Symbol	Min.	Max.
A	2.20	2.40
A1	0.00	0.20
A2	0.97	1.17
b	0.68	0.90
b3	5.20	5.50
c	0.43	0.63
D	5.98	6.22
D1	5.30REF	
E	6.40	6.80
E1	4.63	-

Unit: mm		
Symbol	Min.	Max.
e	2.286BSC	
H	9.40	10.50
L	1.38	1.75
L1	2.90REF	
L2	0.51BSC	
L3	0.88	1.28
L4	-	1.00
L5	1.65	1.95
θ	0°	8°

Disclaimer

All product specifications and data are subject to change without notice.

For documents and material available from this datasheet, Suzhou Convert does not warrant or assume any legal liability or responsibility for the accuracy, completeness of any product or technology disclosed hereunder.

No license, express or implied, by estoppels or otherwise, to any intellectual property rights is granted by this document or by any conduct of Suzhou Convert.

The products shown herein are not designed for use in medical, life-saving, or life-sustaining applications unless. Customers using or selling Suzhou Convert products not expressly indicated for use in such applications do so entirely at their own risk and agree to fully indemnify Suzhou Convert for any damages arising or resulting from such use or sale.

Suzhou Convert disclaims any and all liability arising out of the use or application of any product described herein or of any information provided herein to the maximum extent permitted by law. The product specifications do not expand or otherwise modify Suzhou Convert's terms and conditions of purchase, including but not limited to the warranty expressed therein, which apply to these products.

Suzhou Convert Semiconductor CO., Ltd. strives to supply high-quality high-reliability products. However, any and all semiconductor products fail with some probability. It is possible that these probabilistic failures could give rise to accidents or events that could endanger human lives that could give rise to smoke or fire, or that could cause damage to other property. When designing equipment, adopt safety measures so that these kinds of accidents or events cannot occur. Such measures include but are not limited to protective circuits and error prevention circuits for safe design, redundant design, and structural design.

In the event that any or all Suzhou Convert products(including technical data, services) described or contained herein are controlled under any of applicable local export control laws and regulations, such products must not be exported without obtaining the export license from the authorities concerned in accordance with the above law.

Information (including circuit diagrams and circuit parameters) herein is for example only; it is not guaranteed for volume production. Suzhou Convert believes information herein is accurate and reliable, but no guarantees are made or implied regarding its use or any infringements of intellectual property rights or other rights of third parties.