

Features and Benefits

- **BiCMOS Technology**
- **Wide Operating Voltage Range:**
Supply Voltage 2.8~24V
- **Specified Operating Temperature**

Range: From -40°C~150°C
- **Low Operating Current:** 2.3mA
- **Lead Free Package**
Flat TO-92, SOT-23
- **Open Drain Output**
- **Reverse Battery Protection**
- **RoHS Compliant:**2011/65/EU

Applications

- **Solid-state Switch**
- **Speed Detection**
- **Angular Position Detection**
- **Proximity Detection**

Family Members

Part number	Description
MT3303A-EN	Flat TO-92 package, bulk packaging (1000pcs/bag)
MT3303AT-EN	SOT-23 package, tape and reel packaging(3000pcs/bag)

General Description

The MT3303-EN family are Hall-effect omni-polar switch designed in mixed-signal technology. The Hall IC internally includes a voltage regulator for operation with supply voltage of 2.8 to 24V, a dynamic offset cancellation system, a Schmitt trigger and an open-drain output driver, all in a single package.

As to its wide operating voltage range and extended choice of temperature range, it is quite suitable for use in automotive, industrial and consumer applications. It also includes an anti-reverse bias block to prevent from reverse bias condition.

MT3303-EN series provide a variety of packages to customers: SOT-23 for surface mount and flat TO-92 for through-hole mount. All packages are RoHS compliant.

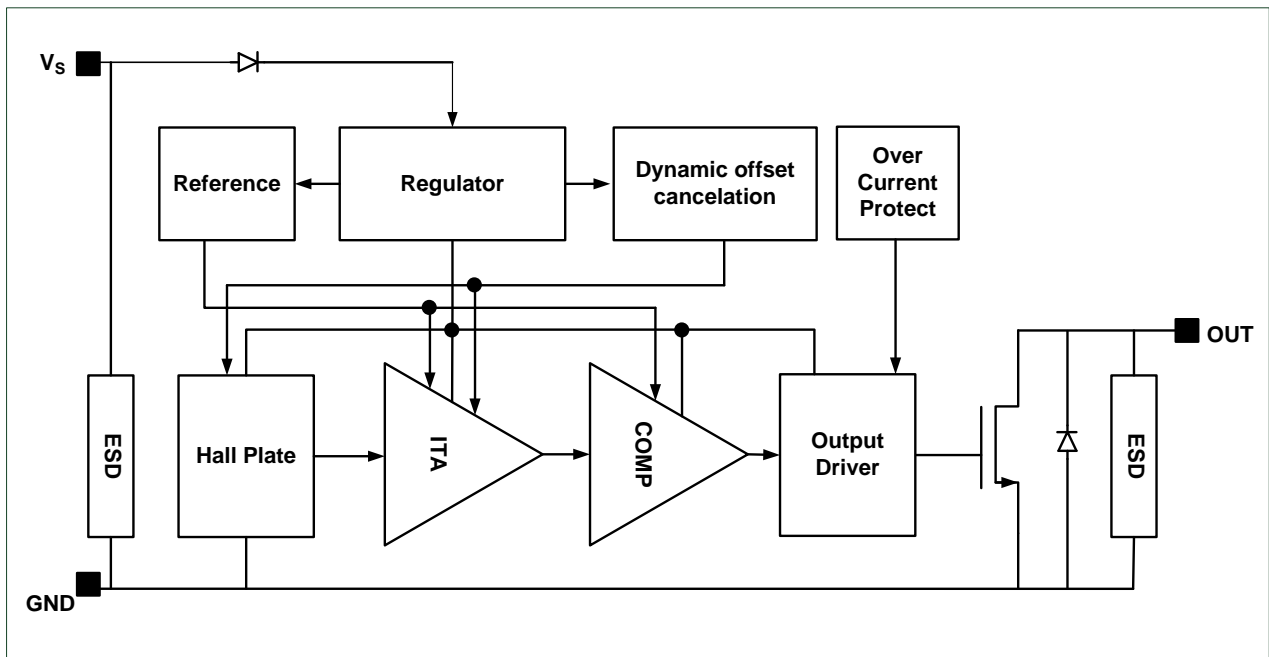

Functional Block Diagram

Function Description

Definition of Magnetic Parameters

B_{OP} : Operating Point, Magnetic flux density applied on the branded side of the package which turns the output driver ON ($V_{OUT}=Low$)

B_{RP} : Release Point, Magnetic flux density applied on the branded side of the package which turns the output driver OFF ($V_{OUT}=High$)

B_{HYST} : Hysteresis Window, $|B_{OP}-B_{RP}|$

Definition of Switching Function

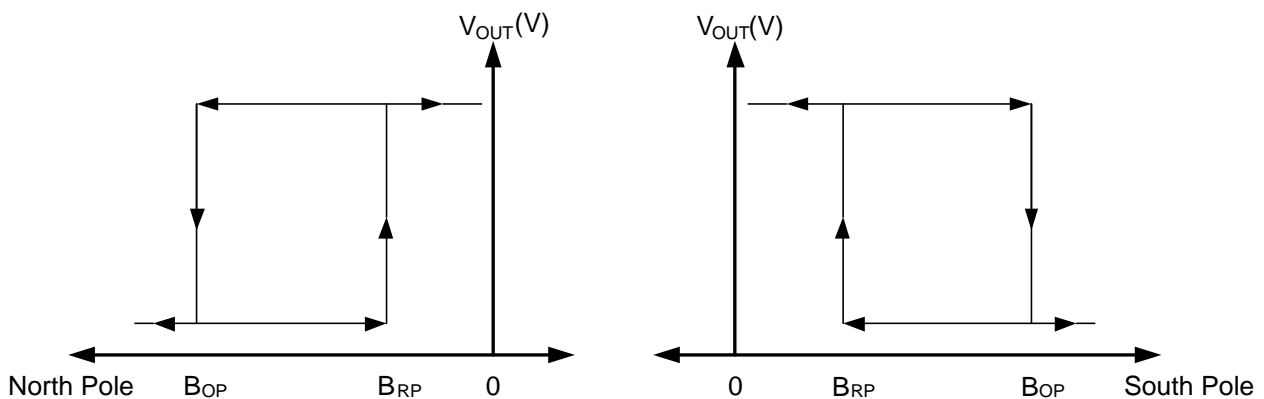

Switching Behavior

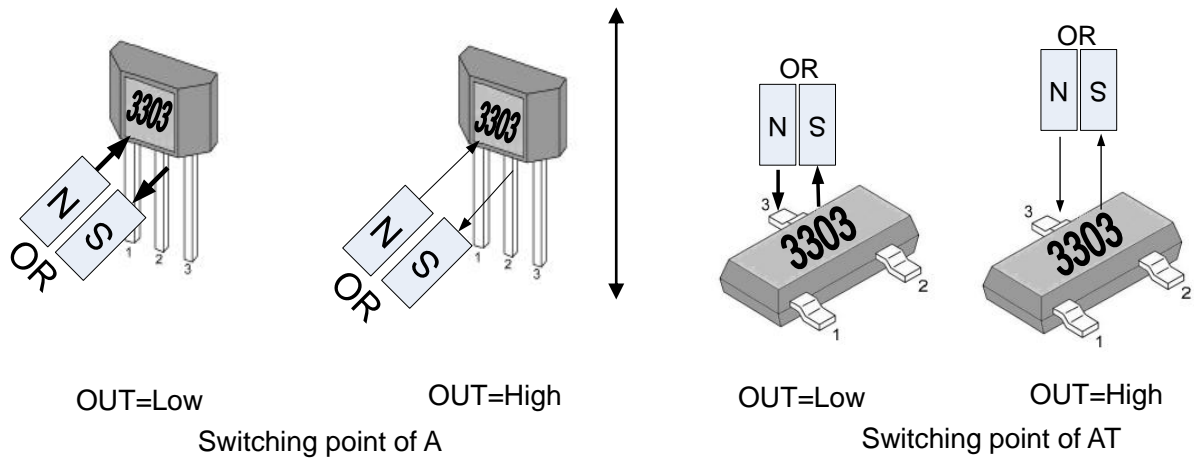

Note: \longleftrightarrow Direction of magnetic flux, \longrightarrow Close to the chip, \longleftarrow Far away to the chip

Pin Description

MT3303A-EN

Name	Number	Description
V _S	1	Power
GND	2	Ground
OUT	3	Open-drain Output

MT3303AT-EN

Name	Number	Description
V _S	1	Power
GND	3	Ground
OUT	2	Open-drain Output

Electrical and Magnetic Characteristics

Absolute Maximum Ratings

Absolute maximum ratings are limiting values to be applied individually, and beyond which the serviceability of the circuit may be impaired. Functional operability is not necessarily implied. Exposure to absolute maximum rating conditions for an extended period of time may affect device reliability.

Absolute maximum ratings: all voltages listed are referenced to GND.

Symbol	Parameters	Min	Max	Units
V _S	Supply Voltage	-	27	V
V _{RCC}	Reverse Battery Voltage	-27	-	V
V _{OUT}	Output Voltage	-	27	V
I _{OUT}	Continuous output current	-	50	mA
T _A	Operating ambient Temperature	-40	150	°C
T _S	Storage temperature	-50	165	°C
T _J	Junction Temperature	-	165	°C
B	Magnetic Flux	No Limit		Gauss

Power derating Curve

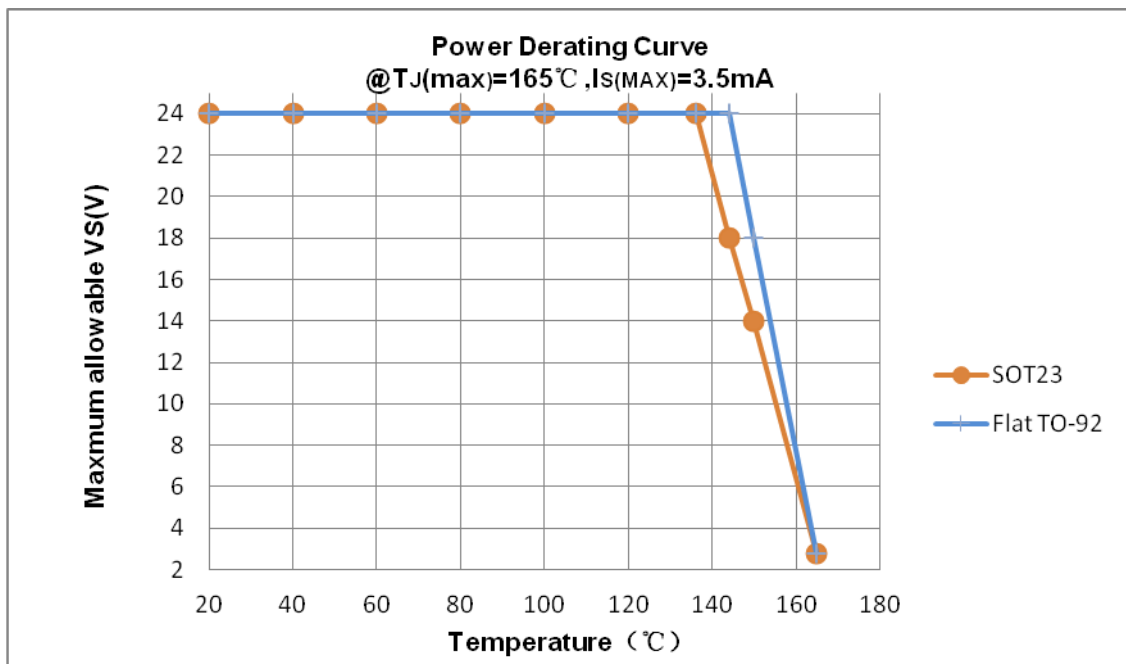

MT3303-EN Specifications

At $T_A = -40$ to 150°C , $V_S = 2.8\text{V}$ to 24V (unless otherwise specified)

Symbol	Parameter	Test Condition	Min	Typ	Max	Units
V_S	Supply Voltage	Operating	2.8	-	24	V
I_S	Supply Current	$B < B_{RP}$	1	2.3	3.5	mA
I_{OCP}	Short Circuit Protection Current	$B > B_{OP}$, $V_{OUT} = V_S$		50		mA
V_{DSON}	Output Saturation Voltage	$I_{OUT} = 20\text{mA}$, $B > B_{OP}$	-	-	0.4	V
I_{OL}	Output Leakage Current	$V_{OUT} = 24\text{V}$, $B < B_{RP}$	-	-	10	μA
$T_R^{1,2}$	Output Rise Time	$R_L = 1\text{K}\Omega$, $C_L = 20\text{pF}$	-	-	1.0	μs
$T_F^{1,2}$	Output Fall Time	$R_L = 1\text{K}\Omega$, $C_L = 20\text{pF}$	-	-	1.0	μs
T_{PO}^1	Power On Time	$dV_S/dt > 5\text{V}/\mu\text{S}$, $B > B_{OP(MAX)}$	-	-	25	μs
F_C^1	Chopping Frequency		-	200	-	KHz
R_{TH}	SOT-23 Package Thermal Resistance		-	301	-	$^\circ\text{C}/\text{W}$
	TO-92 Package Thermal Resistance		-	230	-	$^\circ\text{C}/\text{W}$
B_{OPS}	Magnetic Operating Point of South Pole	$T_A = 25^\circ\text{C}$	90	150	190	Gauss
B_{RPS}	Magnetic Release Point of South Pole		70	120	160	Gauss
B_{HYSTS}	Hysteresis Window of South Pole		10	30	50	Gauss
B_{OPN}	Magnetic Operating Point of North Pole	$T_A = 25^\circ\text{C}$	-190	-150	-90	Gauss
B_{RPN}	Magnetic Release Point of North Pole	$T_A = 25^\circ\text{C}$	-160	-120	-70	Gauss
B_{HYSTN}	Hysteresis Window of North Pole		-50	-30	-10	Gauss

1 Guaranteed by device design and characterization.

2 CL = oscilloscope probe capacitance.

Characteristic Performance

Average Supply Current versus Supply Voltage

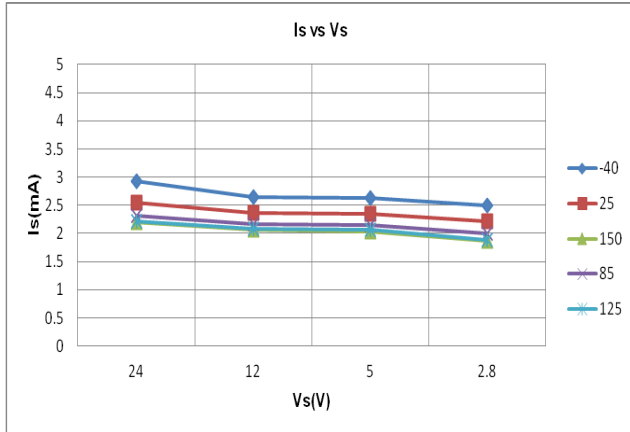

Average Supply Current versus Temperature

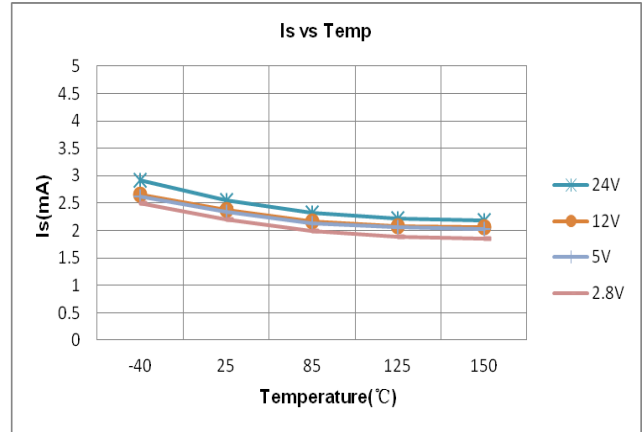

Magnetic Characteristics versus Temperature
Vs=2.8V

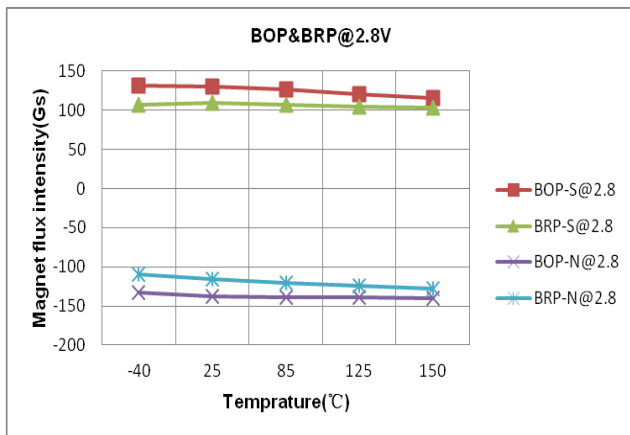

Magnetic Characteristics versus Temperature
Vs=5V

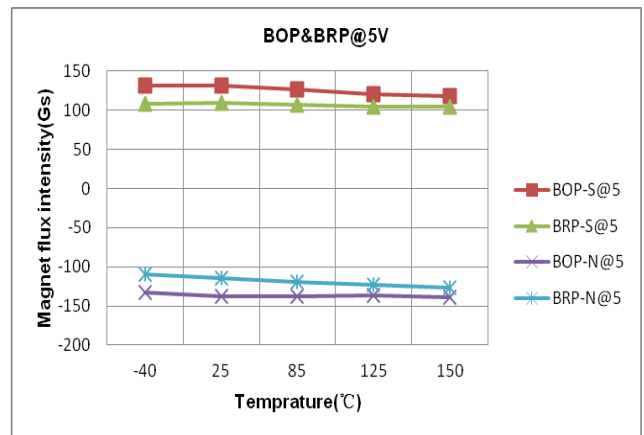

Magnetic Characteristics versus Temperature
Vs=12V

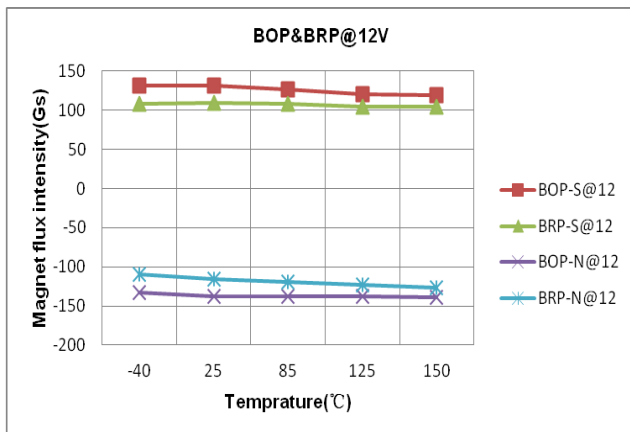

Magnetic Characteristics versus Temperature
Vs=24V

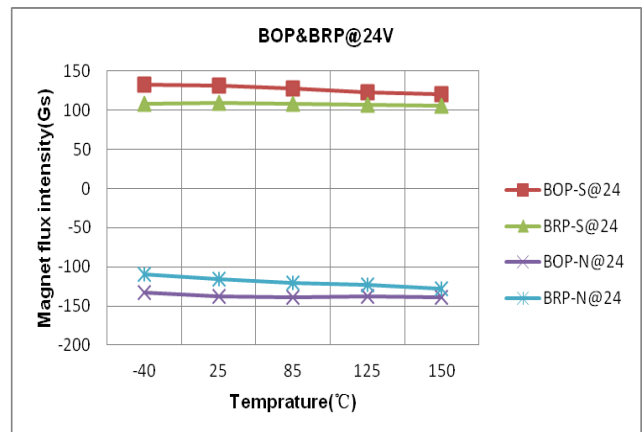

Typical Application Circuit Note: R_L recommend 1KOhm to 10KOhm

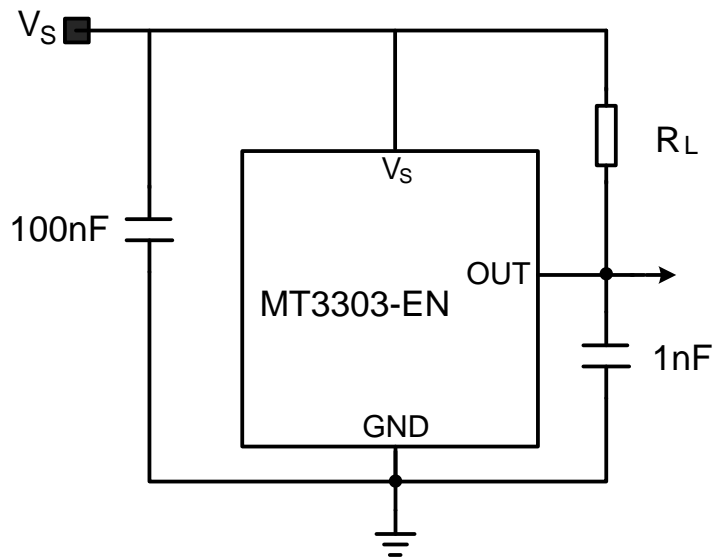

Typical Output Waveform

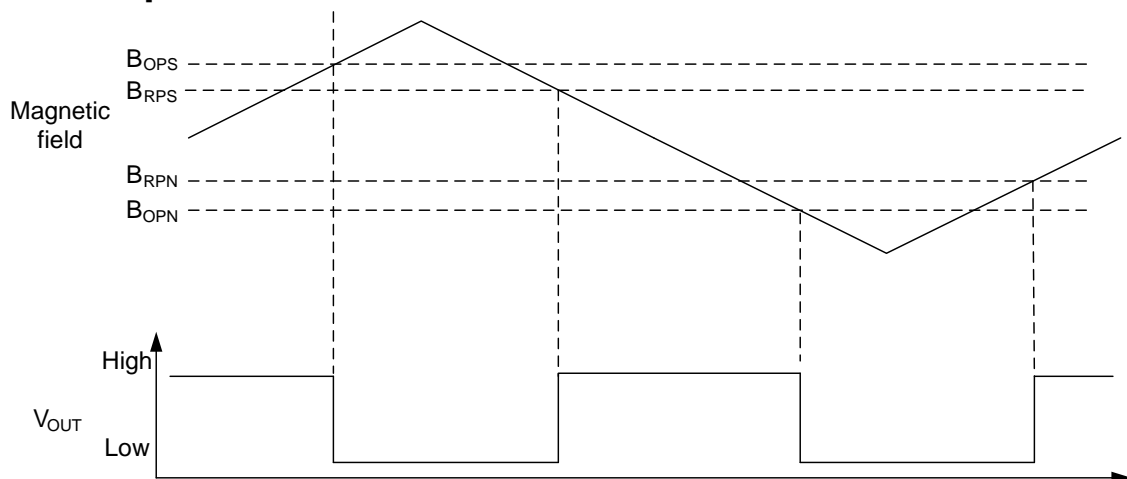

Power On Output Waveform (The Flat TO-92 package as an example)

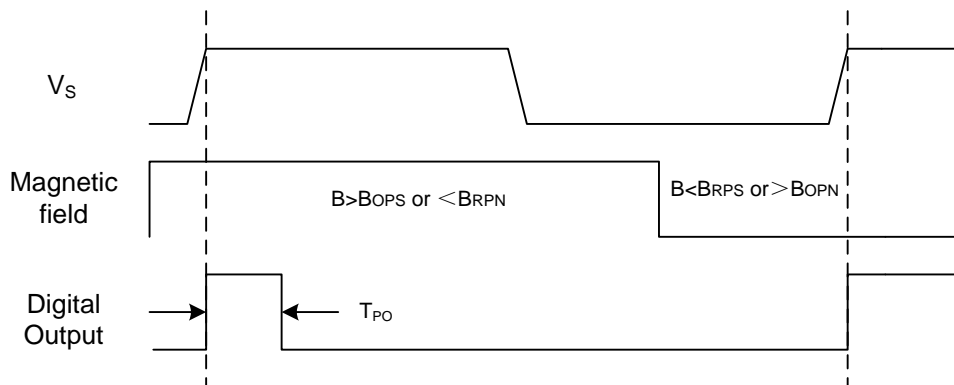

Note: V_s rise time $< 1\mu s$, T_{PO} is the time from V_s becoming stable to output becoming valid.

PACKAGE DESIGNATOR (MT3303AT-EN) SOT-23

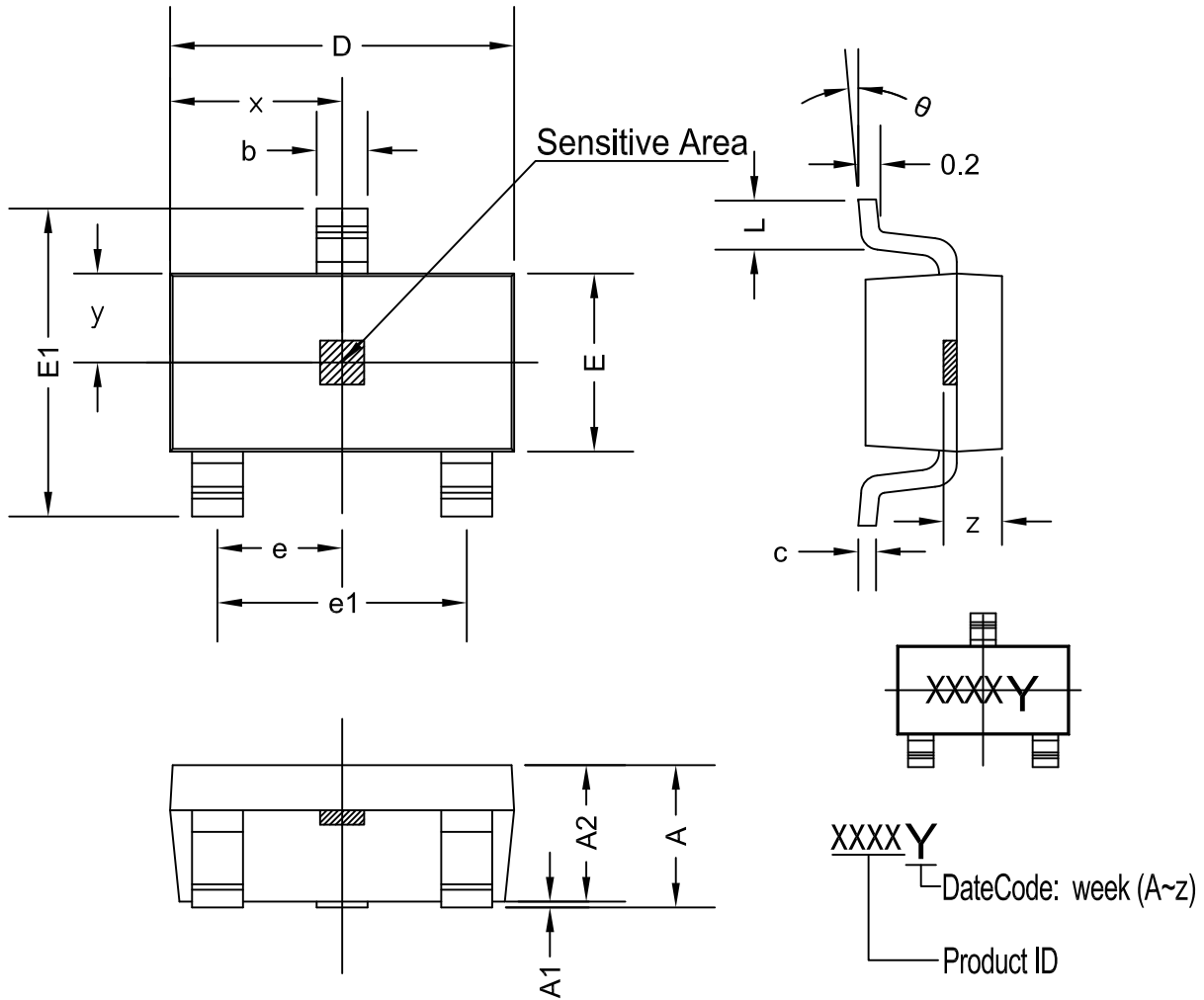

Symbol	Dimensions in Millimeters		Dimensions in Inches	
	Min	Max	Min	Max
A	1.050	1.250	0.041	0.049
A1	0.000	0.100	0.000	0.004
A2	1.050	1.150	0.041	0.045
b	0.300	0.500	0.012	0.020
c	0.100	0.200	0.004	0.008
D	2.820	3.020	0.111	0.119
E	1.500	1.700	0.059	0.067
E1	2.650	2.950	0.104	0.116
e	0.950 TYP		0.037 TYP	
e1	1.800	2.000	0.071	0.079
L	0.300	0.600	0.012	0.024
x	1.460TYP		0.057TYP	
y	0.800TYP		0.032TYP	
z	0.600TYP		0.024TYP	
θ	0°	8°	0°	8°