



ZINC OXIDE VARISTOR

德欣集团 深圳市德欣电器有限公司

规格书

产品名称：突波吸收器(压敏电阻)型

号规格：05D~20D(全系列)

日期：2019年01月01日

本集团公司旗下总生产面积 60000 平方米以上，主营产品压敏芯片及压敏电阻器，电压范围从 15V--1800V，产品直径从3mm--80mm均能全系列生产，年产能压敏芯片12亿只以上，压敏电阻器成品8亿只以上，综合年产能20亿只以上，为国内压敏芯片，压敏电阻器产能最大生产商之一，其中(15V-82V)低压压敏芯片，产能，产量，市场占有率位居世界第一。本公司旗下所生产的全系列产品均有完善的认证体系：具备CQC，UL，CSA，VDE，SGS等多国认证，产品畅销多个国家，全员推行并遵守ISO9001质量管理体系，ISO14001环境管理体系，OHSAS18001职业健康安全管理体系，拥有国家发明专利6项，实用新型专利7项，为高新技术企业。

*** THE PRODUCTION PROCESS ***

生产流程

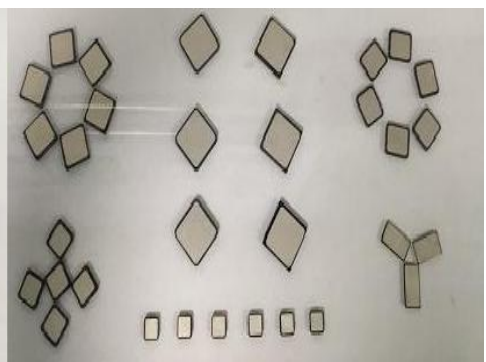
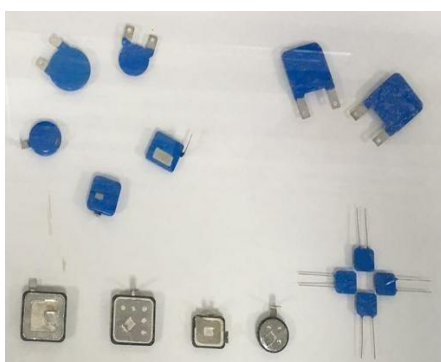

华北生产基地：山东省德州市平原县经济开发区德欣电器高新科技产业园

华南生产基地：惠州市惠阳区秋长将军路合美兴工业园

西南生产基地：四川省南充市阆中市七里汉王祠路小微企业孵化园 3号

联系人：黄泽玲

移动电话：13417457991

固定电话：0755-82785987



ZINC OXIDE VARISTOR

工厂外景图：影背墙



工厂外景图：办公大楼



工厂外景图：一号车间





ZINC OXIDE VARISTOR

工厂外景图：二号车间



工厂外景图：三号车间



工厂外景图：四号车间





ZINC OXIDE VARISTOR

工厂外景图：员工餐厅楼



工厂外景图：员工宿舍楼



工厂外景图：工厂侧视全景





ZINC OXIDE VARISTOR

工厂外景图：办公大楼接待室



工厂外景图：办公大楼会议室



工厂外景图：职工/贵宾餐厅



工厂车间场景图：造粒车间





ZINC OXIDE VARISTOR

工厂车间场景图：压片车间



工厂车间图：排胶烧结车间



工厂车间图：箱式排胶车间



工厂车间图：排片生产车间



工厂车间图：涂银还原车间



工厂车间图：铜浆生产线





ZINC OXIDE VARISTOR

工厂车间图：芯片分选车间



工厂车间图：三合一生产车间



工厂车间图：环氧封装站



工厂车间图：成品打印测试



工厂车间图：外观全检



工厂车间图：编带产品生产线





ZINC OXIDE VARISTOR

工厂车间图：SPD、TMOV回焊炉站



工厂车间图：SPD、TMOV生产车间



工厂车间图：部分TFMOV、TMOV成品



品质部：检测中心



品质部：大型模拟雷电试验平台





ZINC OXIDE VARISTOR

品质部：体系及认证



研发部：部分知识产权展示



行政部：合作单位及荣誉





ZINC OXIDE VARISTOR

Explanation of Part Numbers 型号说明:

| | | | | | | | | | | | | | | | | | | | | |
|--|----------------------------------|---|--------------------|--|--|--|-----------------|--------------------------------|---|-------------------------|---|---|---|---|---|---|--|--|---|--|
| COV | | | D | | | | K | | | | | | | | | | | | | |
| Common Code 产品类别代码 | Chip Diameter 芯片直径 | | Chip Shape 芯片形状 | Varistor Voltage 压敏电阻动作电压 | | | Tolerance 误差 | High Surge/Lead Style 高焦/脚型 | | Length/Packing 脚长/包装 | | | | | | | | | | |
| DE xin COV Metal Oxide Varistor Surge Absorber 德欣 COV 金属氧化物压敏电阻器 | 05 07 10 14 20 25 | Φ 5mm Φ 7mm Φ 10mm Φ 14mm Φ 20mm | 圆形 Disc | 例如 <table border="1"> <tr><td>4</td><td>7</td><td>0</td></tr> </table> $47 \times 10^0 = 47 \text{ V}$ <table border="1"> <tr><td>4</td><td>7</td><td>1</td></tr> </table> $47 \times 10^1 = 470 \text{ V}$ <table border="1"> <tr><td>1</td><td>1</td><td>2</td></tr> </table> $11 \times 10^2 = 1100 \text{ V}$ | | | 4 | 7 | 0 | 4 | 7 | 1 | 1 | 1 | 2 | K ±10% L ±15% M ±20% Or Customer Special Requirement | <input type="checkbox"/> 空白常规 <input type="checkbox"/> J 高能品 <input type="checkbox"/> S直脚 <input type="checkbox"/> O外弯脚 <input type="checkbox"/> I内弯脚 <input type="checkbox"/> H高低脚 | | 空白表散装 $3.5 \pm 0.5 \text{ mm}$ $5.0 \pm 0.5 \text{ mm} \times 10$ $0 \pm 0.5 \text{ mm}$ <input type="checkbox"/> B散装 <input type="checkbox"/> R卷装 <input type="checkbox"/> A盒装 | |
| 4 | 7 | 0 | | | | | | | | | | | | | | | | | | |
| 4 | 7 | 1 | | | | | | | | | | | | | | | | | | |
| 1 | 1 | 2 | | | | | | | | | | | | | | | | | | |

Specifications 规格说明:

| | |
|--|------------------------------|
| □Varistor Voltage Range 压敏电阻动作电压范围 | 18V~1800V(dc) |
| □Peak Current For 8/20us Current Wave 在 8/20us电流波形最大通流量 | 100A~1800A |
| □Energy Range For 10/1000us Current Wave 在 10/1000us电流波形的能量范围 | 0.4J~1092J |
| □Storage Temperature Range 储存温度范围 | -40℃~125℃ |
| □Operation Ambient Temperature Range 作业环境温度范围储存温度范围 | -40℃~85℃ |
| □Typical Response Time 反应时间 | <25ns |
| □Insulation Resistance 绝缘电阻 | $\cong 1000 \text{ M}\Omega$ |



ZINC OXIDE VARISTOR

•05D Specifiation

Put "J" In Free Code Stands For High Surge Series

| COV Part Number | | Maxlimum Allowable Voltage 最大允许电压 | | Varistor Voltage 压敏电阻器动作电压 $V_{0.1mA}$ (V) | Clamping Voltage(Max) 抑制电压 @ (8/20)us | | Maxlimum Peak Current 最大电流耐量(8/20)us | | Maxlimum Energy 最大吸收能量 (10/1000)us | | Rated Power 消耗功率 (W) | TypcalCapactance (Reference) 参考电容值 @1KHz (pF) |
|--------------------|------------|-----------------------------------|-----|---|---------------------------------------|------|--------------------------------------|-------------------|------------------------------------|------------|-------------------------|--|
| | | AC.rms | DC | | VC | IP | Standard | High Surge | Standard | High Surge | | |
| Standard | High Surge | (V) | | (V) | (V) | (A) | (A) | | (J) | | | |
| 05D180K | J | 11 | 14 | 18(14.4-21.6) | 40 | 1 | 100 / 50×2 | 250 / 100×2 | 0.4 | 0.6 | 0.01 | 1400 |
| 05D220K | J | 14 | 18 | 22(18.7-26) | 48 | | | | 0.5 | 0.7 | | 1150 |
| 05D270K | J | 17 | 22 | 27(23-31.1) | 60 | | | | 0.6 | 0.9 | | 930 |
| 05D330K | J | 20 | 26 | 33(29.5-36.5) | 73 | | | | 0.8 | 1.1 | | 760 |
| 05D390K | J | 25 | 31 | 39(35-43) | 80 | | | | 0.9 | 1.2 | | 640 |
| 05D470K | J | 30 | 38 | 47(42-52) | 104 | | | | 1.1 | 1.5 | | 530 |
| 05D560K | J | 35 | 45 | 56(50-62) | 123 | | | | 1.3 | 1.8 | | 450 |
| 05D680K | J | 40 | 56 | 68(61-75) | 145 | | | | 1.6 | 2.2 | | 370 |
| 05D820K | J | 50 | 65 | 82(74-90) | 150 | 5 | 400 / 200×2 | 800 / 400×2 | 2.5 | 4.0 | 0.10 | 300 |
| 05D101K | J | 60 | 85 | 100(90-110) | 175 | | | | 3.0 | 4.1 | | 250 |
| 05D121K | J | 75 | 110 | 120(108-132) | 210 | | | | 4.0 | 4.9 | | 210 |
| 05D151K | J | 95 | 125 | 150(135-165) | 260 | | | | 4.8 | 6.5 | | 165 |
| 05D181K | J | 115 | 150 | 180(162-198) | 320 | | | | 5.9 | 7.5 | | 140 |
| 05D201K | J | 130 | 170 | 200(185-225) | 355 | | | | 6.5 | 8.5 | | 125 |
| 05D221K | J | 140 | 180 | 220(198-242) | 380 | | | | 7.0 | 9.0 | | 110 |
| 05D241K | J | 150 | 200 | 240(216-264) | 415 | | | | 8.0 | 10.5 | | 100 |
| 05D271K | J | 175 | 225 | 270(243-297) | 475 | | | | 8.5 | 11.0 | | 95 |
| 05D301K | J | 190 | 250 | 300(270-330) | 520 | | | | 9.0 | 12.0 | | 85 |
| 05D331K | J | 210 | 275 | 330(297-363) | 570 | | | | 9.5 | 13.0 | | 75 |
| 05D361K | J | 230 | 300 | 360(324-396) | 620 | | | | 1.0 | 16.0 | | 70 |
| 05D391K | J | 250 | 320 | 390(351-429) | 675 | | | | 12.0 | 17.0 | | 65 |
| 05D431K | J | 275 | 350 | 430(387-473) | 745 | | | | 13.0 | 20.0 | | 60 |
| 05D471K | J | 300 | 385 | 470(423-517) | 810 | | | | 15.0 | 21.0 | | 55 |
| 05D511K | J | 320 | 415 | 510(459-561) | 845 | | | | 16.0 | 22.5 | | 50 |
| 05D561K | J | 350 | 460 | 560(504-616) | 920 | 16.8 | 24.0 | 45 | | | | |
| 05D621K | J | 385 | 505 | 620(558-682) | 1025 | 17.7 | 26.6 | 40 | | | | |
| 05D681K | J | 420 | 560 | 680(612-748) | 1120 | 19.4 | 29.1 | 38 | | | | |
| 05D751K | J | 460 | 615 | 750 (675-825) | 1240 | 22.4 | 32.0 | 30 | | | | |



ZINC OXIDE VARISTOR

•07D Specification

Put "J" In Free Code Stands For High Surge Series

| COV Part Number | | Maxlimum Allowable Voltage 最大允许电压 | | Varistor Voltage 压敏电阻器动作电压 V _{1.0mA} (V) | Clamping Voltage(Max) 抑制电压@(8/20)us | | Maxlimum Peak Current 最大电流耐量(8/20)us | | Maxlimum Energy 最大吸收能 (10/1000)us | | Rated Power 消耗功率 (W) | Typical Capacitance (Reference) 参考电容值 @1KHz (pF) |
|--------------------|------------|-----------------------------------|-----|---|-------------------------------------|------|--------------------------------------|---------------------|-----------------------------------|------------|----------------------------|---|
| | | AC.rms | DC | | VC | IP | Standard | High Surge | Standard | High Surge | | |
| Standard | High Surge | (V) | | | (V) | (A) | (A) | | (J) | | | |
| 07D180K | J | 11 | 14 | | 18(14.4-21.6) | 40 | 2.5 | 250 / 125×2 | 500 / 250×2 | 0.9 | | |
| 07D220K | J | 14 | 18 | 22(18.7-26) | 48 | 1.1 | | | | 2.4 | 2300 | |
| 07D270K | J | 17 | 22 | 27(23-31.1) | 60 | 1.4 | | | | 3.0 | 1800 | |
| 07D330K | J | 20 | 26 | 33(29.5-36.5) | 73 | 1.7 | | | | 3.5 | 1500 | |
| 07D390K | J | 25 | 31 | 39(35-43) | 80 | 2.1 | | | | 4.0 | 1300 | |
| 07D470K | J | 30 | 38 | 47(42-52) | 104 | 2.5 | | | | 5.0 | 1100 | |
| 07D560K | J | 35 | 45 | 56(50-62) | 123 | 3.1 | | | | 6.0 | 890 | |
| 07D680K | J | 40 | 56 | 68(61-75) | 145 | 3.6 | | | | 7.0 | 740 | |
| 07D820K | J | 50 | 65 | 82(74-90) | 150 | 10 | 1200 / 600×2 | 1750 / 1200×2 | 5.5 | 10.0 | 0.25 | 600 |
| 07D101K | J | 60 | 85 | 100(90-110) | 175 | | | | 6.5 | 12.0 | | 500 |
| 07D121K | J | 75 | 110 | 120(108-132) | 210 | | | | 7.8 | 13.0 | | 420 |
| 07D151K | J | 95 | 125 | 150(135-165) | 260 | | | | 9.7 | 15.0 | | 330 |
| 07D181K | J | 115 | 150 | 180(162-198) | 320 | | | | 11.7 | 16.0 | | 280 |
| 07D201K | J | 130 | 170 | 200(185-225) | 355 | | | | 13.0 | 17.0 | | 250 |
| 07D221K | J | 140 | 180 | 220(198-242) | 380 | | | | 14.0 | 19.0 | | 230 |
| 07D241K | J | 150 | 200 | 240(216-264) | 415 | | | | 15.0 | 21.0 | | 210 |
| 07D271K | J | 175 | 225 | 270(243-297) | 475 | | | | 18.0 | 24.0 | | 185 |
| 07D301K | J | 190 | 250 | 300(270-330) | 520 | | | | 20.0 | 26.0 | | 165 |
| 07D331K | J | 210 | 275 | 330(297-363) | 570 | | | | 23.0 | 28.0 | | 150 |
| 07D361K | J | 230 | 300 | 360(324-396) | 620 | | | | 24.0 | 32.0 | | 140 |
| 07D391K | J | 250 | 320 | 390(351-429) | 675 | | | | 26.0 | 35.0 | | 130 |
| 07D431K | J | 275 | 350 | 430(387-473) | 745 | | | | 28.0 | 40.0 | | 115 |
| 07D471K | J | 300 | 385 | 470(423-517) | 810 | | | | 29.0 | 42.0 | | 105 |
| 07D511K | J | 320 | 415 | 510(459-561) | 845 | | | | 31.0 | 45.0 | | 100 |
| 07D561K | J | 350 | 460 | 560(504-616) | 920 | | | | 35.0 | 49.0 | | 90 |
| 07D621K | J | 385 | 505 | 620(558-682) | 1025 | | | | 38.0 | 55.0 | | 80 |
| 07D681K | J | 420 | 560 | 680(612-748) | 1120 | | | | 42.0 | 60.0 | | 75 |
| 07D751K | J | 460 | 615 | 750(675-825) | 1240 | | | | 45.0 | 64 | | 70 |
| 07D781K | J | 485 | 640 | 780(702-858) | 1290 | 48.0 | 69 | 65 | | | | |
| 07D821K | J | 510 | 670 | 820(738-902) | 1355 | 52.0 | 73 | 60 | | | | |



ZINC OXIDE VARISTOR

•10D Specification

Put "J" In Free Code Stands For High Surge Series

| COV Part Number | | Maximum Allowable Voltage 最大允许电压 | | Varistor Voltage 压敏电阻器动作电压 $V_{1.0mA}$ (V) | Clamping Voltage (Max.)抑制电压 @ (8/20)us | | Maximum Peak Current 最大电流耐受量(8/20)us | | Maximum Energy 最大吸收能量 (10/1000)us | | Rated Power 消耗功率 (W) | Typical Capacitance (Reference) 参考电容值 @1KHz (pF) |
|--------------------|------------|----------------------------------|-----|---|--|--------|--------------------------------------|---------------------|-----------------------------------|----------------|----------------------|--|
| | | AC.rms | DC | | VC (V) | IP (A) | Standard (A) | High Surge (A) | Standard (J) | High Surge (J) | | |
| Standard | High Surge | (V) | | | (V) | (A) | (A) | (J) | | | | |
| 10D180K | J | 11 | 14 | 18(14.4-21.6) | 36 | 5 | 500 / 250×2 | 1000 / 500×2 | 2.1 | 3.0 | 0.05 | 5600 |
| 10D220K | J | 14 | 18 | 22(18.7-26) | 43 | | | | 2.5 | 5.0 | | 4500 |
| 10D270K | J | 17 | 22 | 27(23-31.1) | 53 | | | | 3.0 | 6.0 | | 3700 |
| 10D330K | J | 20 | 26 | 33(29.5-36.5) | 65 | | | | 4.0 | 7.0 | | 3000 |
| 10D390K | J | 25 | 31 | 39(35-43) | 77 | | | | 4.6 | 9.0 | | 2400 |
| 10D470K | J | 30 | 38 | 47(42-52) | 93 | | | | 5.5 | 11.0 | | 2100 |
| 10D560K | J | 35 | 45 | 56(50-62) | 110 | | | | 7.0 | 13.0 | | 1800 |
| 10D680K | J | 40 | 56 | 68(61-75) | 135 | | | | 8.2 | 15.0 | | 1500 |
| 10D820K | J | 50 | 65 | 82(74-90) | 135 | 25 | 2500 / 1250×2 | 3500 / 2500×2 | 12.0 | 17.0 | 0.40 | 1200 |
| 10D101K | J | 60 | 85 | 100(90-110) | 165 | | | | 15.0 | 18.0 | | 1000 |
| 10D121K | J | 75 | 110 | 120(108-132) | 200 | | | | 18.0 | 21.0 | | 830 |
| 10D151K | J | 95 | 125 | 150(135-165) | 250 | | | | 22.0 | 25.0 | | 670 |
| 10D181K | J | 115 | 150 | 180(162-198) | 300 | | | | 27.0 | 30.0 | | 560 |
| 10D201K | J | 130 | 170 | 200(185-225) | 340 | | | | 30.0 | 35.0 | | 500 |
| 10D221K | J | 140 | 180 | 220(198-242) | 360 | | | | 32.0 | 39.0 | | 450 |
| 10D241K | J | 150 | 200 | 240(216-264) | 395 | | | | 35.0 | 42.0 | | 420 |
| 10D271K | J | 175 | 225 | 270(243-297) | 455 | | | | 37.0 | 49.0 | | 370 |
| 10D301K | J | 190 | 250 | 300(270-330) | 500 | | | | 40.0 | 54.0 | | 330 |
| 10D331K | J | 210 | 275 | 330(297-363) | 550 | | | | 43.0 | 58.0 | | 300 |
| 10D361K | J | 230 | 300 | 360(324-396) | 595 | | | | 47.0 | 65.0 | | 280 |
| 10D391K | J | 250 | 320 | 390(351-429) | 650 | | | | 60.0 | 70.0 | | 260 |
| 10D431K | J | 275 | 350 | 430(387-473) | 710 | | | | 65.0 | 80.0 | | 230 |
| 10D471K | J | 300 | 385 | 470(423-517) | 775 | | | | 67.0 | 85.0 | | 210 |
| 10D511K | J | 320 | 415 | 510(459-561) | 845 | | | | 69.0 | 90.0 | | 200 |
| 10D561K | J | 350 | 460 | 560(504-616) | 925 | | | | 70.0 | 92.0 | | 180 |
| 10D621K | J | 385 | 505 | 620(558-682) | 1025 | | | | 72.0 | 95.0 | | 160 |
| 10D681K | J | 420 | 560 | 680(612-748) | 1120 | | | | 75.0 | 98.0 | | 150 |
| 10D751K | J | 460 | 615 | 750(675-825) | 1240 | | | | 77.0 | 100.0 | | 130 |
| 10D781K | J | 485 | 640 | 780(702-858) | 1290 | 80.0 | 105.0 | 125 | | | | |
| 10D821K | J | 510 | 670 | 820(738-902) | 1355 | 85.0 | 110.0 | 120 | | | | |
| 10D911K | J | 550 | 745 | 910(819-1001) | 1500 | 93.0 | 130.0 | 110 | | | | |
| 10D102K | J | 625 | 825 | 1000(900-1100) | 1650 | 102.0 | 140.0 | 100 | | | | |
| 10D112K | J | 680 | 895 | 1100(990-1210) | 1815 | 115.0 | 155.0 | 90 | | | | |



ZINC OXIDE VARISTOR

•14D Specification

Put "J" In Free Code Stands For High Surge Series

| COV Part Number | | Maxlimum Allowable Voltage 最大允许电压 | | Varistor Voltage 压敏电阻器动作电压 $V_{1.0mA}$ (V) | Clamping Voltage (Max.) 抑制电压 @ (8/20)us Vc IP | | Maxlimum Peak Current 最大电流耐量 (8/20)us Standard High Surge | | Maxlimum Energy 最大吸收能 (10/1000)us Standard High Surge | | Rated Power 消耗功率 (W) | Typical Capacitance (Reference) 参考电容值 @ 1KHz (pF) |
|--------------------|---|-----------------------------------|------|---|--|-------|--|---------------|--|-------|----------------------|---|
| | | AC.rms | DC | | (V) | (V) | (A) | (A) | (J) | | | |
| 14D180K | J | 11 | 14 | 18(14.4-21.6) | 36 | 10 | 1000 / 500×2 | 2000 / 1000×2 | 4.0 | 7.0 | 0.1 | 11100 |
| 14D220K | J | 14 | 18 | 22(18.7-26) | 43 | | | | 5.0 | 8.0 | | 9100 |
| 14D270K | J | 17 | 22 | 27(23-31.1) | 53 | | | | 6.0 | 10.0 | | 7400 |
| 14D330K | J | 20 | 26 | 33(29.5-36.5) | 65 | | | | 7.5 | 12.0 | | 6100 |
| 14D390K | J | 25 | 31 | 39(35-43) | 77 | | | | 8.6 | 13.0 | | 5100 |
| 14D470K | J | 30 | 38 | 47(42-52) | 93 | | | | 10.0 | 17.0 | | 4300 |
| 14D560K | J | 35 | 45 | 56(50-62) | 110 | | | | 11.0 | 20.0 | | 3600 |
| 14D680K | J | 40 | 56 | 68(61-75) | 135 | | | | 14.0 | 24.0 | | 2900 |
| 14D820K | J | 50 | 65 | 82(74-90) | 135 | 50 | 4500 / 2500×2 | 6000 / 4500×2 | 22.0 | 27.0 | 0.60 | 2400 |
| 14D101K | J | 60 | 85 | 100(90-110) | 165 | | | | 28.0 | 33.0 | | 2000 |
| 14D121K | J | 75 | 110 | 120(108-132) | 200 | | | | 32.0 | 40.0 | | 1700 |
| 14D151K | J | 95 | 125 | 150(135-165) | 250 | | | | 40.0 | 53.0 | | 1300 |
| 14D181K | J | 115 | 150 | 180(162-198) | 300 | | | | 50.0 | 60.0 | | 1100 |
| 14D201K | J | 130 | 170 | 200(185-225) | 340 | | | | 57.0 | 70.0 | | 1000 |
| 14D221K | J | 140 | 180 | 220(198-242) | 360 | | | | 60.0 | 78.0 | | 900 |
| 14D241K | J | 150 | 200 | 240(216-264) | 395 | | | | 63.0 | 84.0 | | 830 |
| 14D271K | J | 175 | 225 | 270(243-297) | 455 | | | | 70.0 | 99.0 | | 740 |
| 14D301K | J | 190 | 250 | 300(270-330) | 500 | | | | 77.0 | 108.0 | | 670 |
| 14D331K | J | 210 | 275 | 330(297-363) | 550 | | | | 85.0 | 115.0 | | 610 |
| 14D361K | J | 230 | 300 | 360(324-396) | 595 | | | | 93.0 | 130.0 | | 560 |
| 14D391K | J | 250 | 320 | 390(351-429) | 650 | | | | 100.0 | 140.0 | | 510 |
| 14D431K | J | 275 | 350 | 430(387-473) | 710 | | | | 115.0 | 155.0 | | 460 |
| 14D471K | J | 300 | 385 | 470(423-517) | 775 | | | | 118.0 | 175.0 | | 430 |
| 14D511K | J | 320 | 415 | 510(459-561) | 845 | | | | 121.0 | 180.0 | | 390 |
| 14D561K | J | 350 | 460 | 560(504-616) | 925 | | | | 125.0 | 185.0 | | 360 |
| 14D621K | J | 385 | 505 | 620(558-682) | 1025 | | | | 128.0 | 190.0 | | 320 |
| 14D681K | J | 420 | 560 | 680(612-748) | 1120 | | | | 130.0 | 200.0 | | 290 |
| 14D751K | J | 460 | 615 | 750(675-825) | 1240 | | | | 143.0 | 210.0 | | 270 |
| 14D781K | J | 485 | 640 | 780(702-858) | 1290 | | | | 148.0 | 220.0 | | 260 |
| 14D821K | J | 510 | 670 | 820(738-902) | 1355 | | | | 157.0 | 235.0 | | 240 |
| 14D911K | J | 550 | 745 | 910(819-1001) | 1500 | | | | 175.0 | 255.0 | | 220 |
| 14D102K | J | 625 | 825 | 1000(900-1100) | 1650 | | | | 190.0 | 280.0 | | 200 |
| 14D112K | J | 680 | 895 | 1100(990-1210) | 1815 | 213.0 | 310.0 | 180 | | | | |
| 14D122K | J | 750 | 990 | 1200(1080-1320) | 1980 | 232.0 | 324.0 | 160 | | | | |
| 14D142K | J | 880 | 1140 | 1400(1260-1540) | 2310 | 238.0 | 327.0 | 150 | | | | |
| 14D152K | J | 900 | 1200 | 1500(1350-1650) | 2475 | 240.0 | 329.0 | 130 | | | | |
| 14D162K | J | 1000 | 1280 | 1600(1440-1760) | 2640 | 243.0 | 331.0 | 140 | | | | |
| 14D182K | J | 1100 | 1465 | 1800(1620-1980) | 2970 | 250.0 | 335.0 | 130 | | | | |



ZINC OXIDE VARISTOR

•20D Specification

Put "J" In Free Code Stands For High Surge Series

| COV Part Number | | Maxlimum Allowable Voltage 最大允许电 压 | | VaristorVoltage 压敏电阻器 动作电压 | ClampingVoltage (Max.) 抑制电压 @(8/20)us | | Maxlimum Peak Current 最大电流耐量 (8/20)us | | Maxlimum Energy 最大吸收能 (10/1000)us | | Rated Power 消耗功率 (W) | Typical Capacitance (Reference) 参考电容值 @1KHz (pF) |
|--------------------|------------|--|------|----------------------------------|---|-------|--|---------------------|---|------------|-------------------------------|--|
| | | AC.rms | DC | | V _c | IP | Standard | High Surge | Standard | High Surge | | |
| Standard | High Surge | (V) | | V _{1.0mA} (V) | (V) | (A) | (A) | | (J) | | | |
| 20D180K | J | 11 | 14 | 18(14.4-21.6) | 36 | 20 | 2000 / 1000×2 | 3000 / 2000×2 | 11.0 | 13.0 | 0.2 | 28500 |
| 20D220K | J | 14 | 18 | 22(18.7-26) | 43 | | | | 14.0 | 16.0 | | 18500 |
| 20D270K | J | 17 | 22 | 27(23-31.1) | 53 | | | | 16.0 | 19.0 | | 13000 |
| 20D330K | J | 20 | 26 | 33(29.5-36.5) | 65 | | | | 23.0 | 24.0 | | 11500 |
| 20D390K | J | 25 | 31 | 39(35-43) | 77 | | | | 26.0 | 28.0 | | 8500 |
| 20D470K | J | 30 | 38 | 47(42-52) | 93 | | | | 30.0 | 34.0 | | 7400 |
| 20D560K | J | 35 | 45 | 56(50-62) | 110 | | | | 38.0 | 44.0 | | 6500 |
| 20D680K | J | 40 | 56 | 68(61-75) | 135 | | | | 41.0 | 49.0 | | 5800 |
| 20D820K | J | 50 | 65 | 82(74-90) | 135 | | | | 45.0 | 56.0 | | 4900 |
| 20D101K | J | 60 | 85 | 100(90-110) | 165 | | | | 50.0 | 70.0 | | 4000 |
| 20D121K | J | 75 | 110 | 120(108-132) | 200 | 55.0 | 85.0 | 3300 | | | | |
| 20D151K | J | 95 | 125 | 150(135-165) | 250 | 70.0 | 106.0 | 2700 | | | | |
| 20D181K | J | 115 | 150 | 180(162-198) | 300 | 85.0 | 130.0 | 2200 | | | | |
| 20D201K | J | 130 | 170 | 200(185-225) | 340 | 95.0 | 140.0 | 2000 | | | | |
| 20D221K | J | 140 | 180 | 220(198-242) | 360 | 100.0 | 155.0 | 1800 | | | | |
| 20D241K | J | 150 | 200 | 240(216-264) | 395 | 108.0 | 168.0 | 1650 | | | | |
| 20D271K | J | 175 | 225 | 270(243-297) | 455 | 127.0 | 190.0 | 1500 | | | | |
| 20D301K | J | 190 | 250 | 300(270-330) | 500 | 136.0 | 210.0 | 1300 | | | | |
| 20D331K | J | 210 | 275 | 330(297-363) | 550 | 150.0 | 228.0 | 1200 | | | | |
| 20D361K | J | 230 | 300 | 360(324-396) | 595 | 163.0 | 255.0 | 1100 | | | | |
| 20D391K | J | 250 | 320 | 390(351-429) | 650 | 180.0 | 275.0 | 1000 | | | | |
| 20D431K | J | 275 | 350 | 430(387-473) | 710 | 190.0 | 305.0 | 930 | | | | |
| 20D471K | J | 300 | 385 | 470(423-517) | 775 | 204.0 | 350.0 | 850 | | | | |
| 20D511K | J | 320 | 415 | 510(459-561) | 845 | 210.0 | 360.0 | 780 | | | | |
| 20D561K | J | 350 | 460 | 560(504-616) | 925 | 215.0 | 380.0 | 710 | | | | |
| 20D621K | J | 385 | 505 | 620(558-682) | 1025 | 224.0 | 390.0 | 650 | | | | |
| 20D681K | J | 420 | 560 | 680(612-748) | 1120 | 230.0 | 400.0 | 600 | | | | |
| 20D751K | J | 460 | 615 | 750(675-825) | 1240 | 255.0 | 420.0 | 530 | | | | |
| 20D781K | J | 485 | 640 | 780(702-858) | 1290 | 265.0 | 440.0 | 510 | | | | |
| 20D821K | J | 510 | 670 | 820(738-902) | 1355 | 282.0 | 460.0 | 500 | | | | |
| 20D911K | J | 550 | 745 | 910(819-1001) | 1500 | 310.0 | 510.0 | 440 | | | | |
| 20D102K | J | 625 | 825 | 1000(900-1100) | 1650 | 342.0 | 565.0 | 40 | | | | |
| 20D112K | J | 680 | 895 | 1100(990-1210) | 1815 | 383.0 | 620.0 | 360 | | | | |
| 20D122K | J | 750 | 990 | 1200(1080-1320) | 1980 | 408.0 | 660.0 | 350 | | | | |
| 20D142K | J | 880 | 1140 | 1400(1260-1540) | 2310 | 532.0 | 784.0 | 340 | | | | |
| 20D162K | J | 1000 | 1280 | 1600(1440-1760) | 2640 | 606.0 | 896.0 | 330 | | | | |
| 20D182K | J | 1100 | 1465 | 1800(1620-1980) | 2970 | 625.0 | 990.0 | 320 | | | | |



ZINC OXIDE VARISTOR

Dimension of Component for Standard Product 标准品尺寸规格

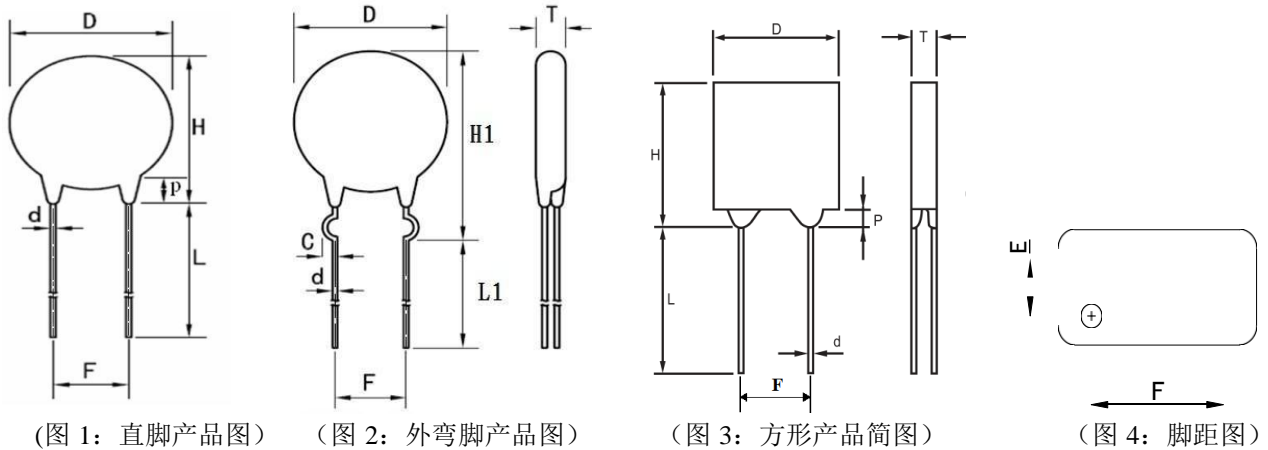

(图 1: 直脚产品图)

(图 2: 外弯脚产品图)

(图 3: 方形产品简图)

(图 4: 脚距图)

Dimension Table 尺寸规格:

Unit:mm

| Sizes | MAX | | | CP Wire d ±0.05 | F ± 1.0 | Lmin | L1min | C ±0.4 | Pmax |
|-------|------|------|------|--------------------|----------|------|-------|--------|------|
| | D | H | H1 | | | | | | |
| 05D | 7.5 | 10.5 | 13 | 0.6 | 5.0±1.0 | 20 | 20 | 1.2 | 3.0 |
| 07D | 9 | 12 | 15 | 0.6 | 5.0±1.0 | 20 | 20 | 1.2 | 3.0 |
| 10D | 12.5 | 16.5 | 19.5 | 0.8 | 7.5±1.0 | 20 | 20 | 1.8 | 3.0 |
| 14D | 16.5 | 20 | 23.5 | 0.8 | 7.5±1.0 | 20 | 20 | 1.8 | 3.0 |
| 20D | 23 | 26.5 | 29.5 | 0.8 | 7.5±1.0 | 20 | 20 | 1.8 | 3.0 |
| | | | | 1.0 | 10.0±1.0 | | | | |

Product Thickness (Tmax) Table 成品厚度尺寸:

Unit :mm



ZINC OXIDE VARISTOR

| Part Code | 05D | 07D | 10D | 14D | 20D | E (± 1.0) |
|-----------|-----|-----|-----|-----|------|-----------------|
| 180K | 3.4 | 3.6 | 4.0 | 4.1 | 4.4 | 1.3 |
| 220K | 3.6 | 3.8 | 4.0 | 4.3 | 4.5 | 1.4 |
| 270K | 3.8 | 4.0 | 4.3 | 4.5 | 4.8 | 1.5 |
| 330K | 3.5 | 3.7 | 4.1 | 4.2 | 4.5 | 1.7 |
| 390K | 3.7 | 3.9 | 4.3 | 4.4 | 4.7 | 1.8 |
| 470K | 3.8 | 4.1 | 4.5 | 4.6 | 4.9 | 1.8 |
| 560K | 3.8 | 4.2 | 4.5 | 4.7 | 4.7 | 1.9 |
| 680K | 4.0 | 4.3 | 4.5 | 4.5 | 5.0 | 2.2 |
| 820K | 3.3 | 3.5 | 3.9 | 4.0 | 4.3 | 1.6 |
| 101K | 3.6 | 3.8 | 4.2 | 4.3 | 4.6 | 1.8 |
| 121K | 3.8 | 4.0 | 4.4 | 4.5 | 4.8 | 2 |
| 151K | 4.1 | 4.3 | 4.7 | 4.8 | 5.1 | 1.8 |
| 181K | 3.2 | 3.4 | 3.8 | 3.9 | 4.2 | 1.6 |
| 201K | 3.3 | 3.5 | 3.9 | 4.0 | 4.3 | 1.7 |
| 221K | 3.4 | 3.6 | 4.0 | 4.1 | 4.4 | 1.7 |
| 241K | 3.5 | 3.7 | 4.1 | 4.2 | 4.5 | 1.8 |
| 271K | 3.7 | 3.9 | 4.2 | 4.3 | 4.6 | 1.9 |
| 301K | 3.9 | 4.1 | 4.3 | 4.4 | 4.7 | 2.1 |
| 331K | 4.0 | 4.2 | 4.5 | 4.6 | 4.9 | 2.2 |
| 361K | 4.1 | 4.3 | 4.7 | 4.8 | 5.1 | 2.3 |
| 391K | 4.2 | 4.4 | 4.8 | 4.9 | 5.2 | 2.5 |
| 431K | 4.4 | 4.6 | 5.0 | 5.1 | 5.4 | 2.5 |
| 471K | 4.8 | 5.0 | 5.2 | 5.5 | 5.8 | 2.6 |
| 511K | 5.0 | 5.2 | 5.5 | 5.6 | 5.9 | 2.6 |
| 561K | 5.2 | 5.4 | 5.7 | 5.8 | 6.1 | 2.8 |
| 621K | 5.3 | 5.5 | 5.7 | 5.8 | 6.1 | 3 |
| 681K | 5.4 | 5.6 | 5.8 | 5.9 | 6.2 | 3.2 |
| 751K | 5.6 | 5.8 | 6.0 | 6.1 | 6.4 | 3.4 |
| 781K | — | 6.0 | 6.3 | 6.4 | 6.7 | 3.7 |
| 821K | — | 6.3 | 6.5 | 6.6 | 6.9 | 3.4 |
| 911K | — | — | 6.6 | 6.7 | 7.0 | 3.7 |
| 102K | — | — | 7.0 | 7.1 | 7.4 | 4 |
| 112K | — | — | 7.4 | 7.5 | 7.9 | 4.3 |
| 122K | — | — | — | 7.7 | 8.1 | 5.2 |
| 142K | — | — | — | 8.7 | 9.1 | 5.6 |
| 152K | — | — | — | 9 | 9 | 6 |
| 162K | — | — | — | 9.7 | 9.9 | 6.7 |
| 182K | — | — | — | 9.7 | 10.1 | 7.4 |

Packaging Specifications 包装说明书

■ Bulk Packaging 散装:



ZINC OXIDE VARISTOR

| Series | Min./Plastic bag Quantity |
|--------|------------------------------|
| 05D | 1000PCS |
| 07D | 1000PCS |
| 10D | 500PCS |
| 14D | 500PCS |
| 20D | 250PCS |
| 25D | 200PCS |

■ Taping Packaging 编带包装:

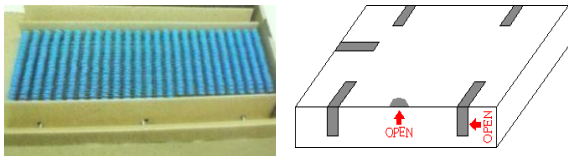
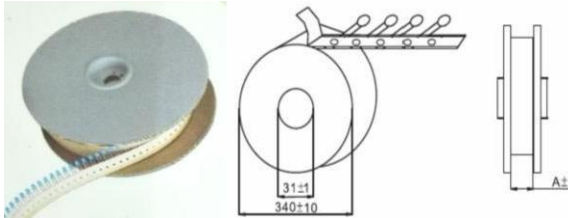
| Packing | Dimensions in mm | Series | Min Quantity(pcs) |
|---------|---|---------|----------------------|
| Ammo |  | 05D、07D | 1500/1000 |
| | | 10D、14D | 1000/750 |
| | | 20D | 500/250 |
| Reel |  | 05D、07D | 1500/1000 |
| | | 10D、14D | 1000/750 |
| | | 20D | 500/250 |

Or Customer Request



ZINC OXIDE VARISTOR

Performance Characteristics (Electrical)性能特性

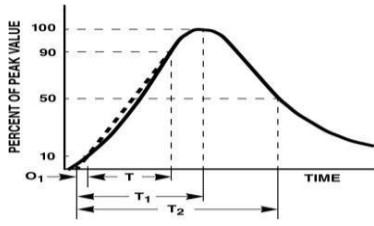
| Test Item/Standard 测试项目/标准 | Test Methods/Description 测试方法/说明 | Specifications 规格值 |
|-------------------------------------|--|--|
| Standard Test Condition 标准测试条件 | Environmental conditions under which every measuring is done without doubt on the measuring results. Unless specified. Temperature humidity are 5 to 35°C 45 to 85%RH. 原则上以室温 25°C, 65%RH 为实验条件, 判定上有疑义时以温度: 室温 5-35°C 相对湿度: 45-85%RH 为条件不特别限定。 | — |
| Maximum Allowable Voltage 最大容许电压 | The maximum sinusoidal RMS voltage or maximum DC voltage that can be applied continuously in the specified environmental Temperature range. 连续施以交流电压或直流电压之最大值 | |
| Varistor Voltage 压敏电压 | The voltage between two terminals with the specified measuring current C mA DC applied is called V _c or V _{c mA} , the measurement shall be made as fast as possible to avoid heat affection. 使用 C mA DC 之电流施以压敏电阻器测量两端之电压即为压敏电压或称 V _c 。为了避免热效应影响, 测量时间尽可能快。(一般为 40ms) | |
| Clamping Voltage 抑制电压 | The maximum voltage between two terminals with the specified standard impulse current (8/20us) illustrated below applied. 使用一标准 8/20 规格脉冲电流通过压敏电阻器, 此时两端之最大电压。  | To meet the specified value 如规格表 |
| Maximum Peak Current 突波耐量 | 2times 2次 | The maximum current within the varistor voltage change of ±10% with the standard impulse current(8/20us) applied two times with an interval of 5 minutes. 以 8/20 之标准波形电流加于压敏电阻器两端两次, 中间间隔 5 分钟, 使压敏电压偏移量在 ±10 以内之最大电流值。 |
| | 1time 1次 | The maximum current within the varistor voltage change of ±10% with the standard impulse current(8/20us) applied one time. 以 8/20 之标准波形电流加与压敏电阻器两端一次, 压敏电压偏移量在 ±10 以内之最大电流值。 |
| Maximum Energy 最大吸收能量 | The maximum energy within the varistor voltage change of ±10% when one impulse of 2ms or 10/1000us is applied. 以 2ms 或 10/1000us 方波加于压敏电阻器上一次, 压敏电压偏移量在 ±10% 以内的能量。 E(能量) = V _m I _m T I _m : 最大容许的方波电流 V _m : 在 I _m 时的最大抑制电压 T: 突波电流的经过时间 (有效波宽) | |



ZINC OXIDE VARISTOR

| | | |
|---|--|-------------------------------------|
| Rated Power 消耗功率 | The power that can be applied in the specified ambient temperature. 在 85±2 °C 的交流电连续施加于压敏电阻器上 1000 小时，压敏电压偏移量在±10% 以内的最大电力。 | |
| Capacitance 电容 | Capacitance shall be measured at 1kHz ±10%.1Vrms max.(1 MHz below 100pF).0V bias and 20±2 °C. 电容应在 1KHz±10%，1Vrms max.,(>100pF 用 1MHz)0V bias 下测得且周围温度是 20±2 °C。 | |
| Dissipation Factor 消散要素 | Dissipation Factor shall be measured at 1KHz±10%.1Vrms max.(1MHz±10% below 100pF).0V bias and 20±2 °C 消散要素应在 1KHz±10%，1Vrms max.,0V bias 下测得且周围温度是 20±2 °C。 | To meet the specified value 如规格表 |
| Temperature Coefficient of Varistor Voltage 电压温度系数 | $\frac{V_c \text{ at } 85^{\circ}\text{C} - V_c \text{ at } 25^{\circ}\text{C}}{V_c \text{ at } 25^{\circ}\text{C}} \times \frac{1}{60} \times 100(\%/^{\circ}\text{C})$ | ±0.05/ °C max |
| Wirhstanding Voltage (Body Insulation) 封装树脂耐压 (本体绝缘性) IEC 61051-1 | The specified voltage shall be applied both terminals of the specimen connected together and metal foil closely wrapped round its body for at AC 2500V 1minute. Electrical breakdown shall be examined. 将封装完成之成品于瓷片上有树脂封装部分，以金属线烧成紧密线圈状，于线圈出头端与铜脚端输入电压 AC 2500V 1 分钟，看其电性崩溃情形。 | No breakdown 无崩溃情形 |

Note:Varistor voltage change of forward direction shall be measured in the test of uni-pole surge life and DC Load life

备注：压敏电阻试验后应以同一方向试验测量电压变化量。



ZINC OXIDE VARISTOR

Mechanical 机械特性

| Test Item/Standard 测试项目/标准 | Test Methods 测试方法 | Specifications 规格值 | | | | | | | | |
|---|--|---|--------------|----------|----------------|----------|----------------|----------|-----------------|--------------------------------|
| Robustness of Terminations (Tenaile) 端子印张强度 IEC 60068-2-21 | <p>After gradually applying the force specified below and keeping the unit fixed for the seconds, the terminal shall be visually examined for any damage.</p> <p>将本体固定后，施予如下之作用力于引线上十秒钟，观察是否有损伤。</p> <table border="1"> <thead> <tr> <th>Terminal diameter 引线直径</th> <th>Force 作用力</th> </tr> </thead> <tbody> <tr> <td>Ø 0.6 mm</td> <td>9.8 N (1.0Kgf)</td> </tr> <tr> <td>Ø 0.8 mm</td> <td>9.8 N (1.0Kgf)</td> </tr> <tr> <td>Ø 1.0 mm</td> <td>19.6 N (2.0Kgf)</td> </tr> </tbody> </table> | Terminal diameter 引线直径 | Force 作用力 | Ø 0.6 mm | 9.8 N (1.0Kgf) | Ø 0.8 mm | 9.8 N (1.0Kgf) | Ø 1.0 mm | 19.6 N (2.0Kgf) | No outstanding damage 无外在损伤 |
| Terminal diameter 引线直径 | Force 作用力 | | | | | | | | | |
| Ø 0.6 mm | 9.8 N (1.0Kgf) | | | | | | | | | |
| Ø 0.8 mm | 9.8 N (1.0Kgf) | | | | | | | | | |
| Ø 1.0 mm | 19.6 N (2.0Kgf) | | | | | | | | | |
| Robustness of Terminations (Bending) 端子弯曲强度 IEC6006802-21 | <p>The unit shall be secured with its terminal kept vertical and the force specified below be applied in the axial direction.</p> <p>The terminal shall gradually be bent by 90° in one direction, then 90° in the opposite direction, and again back to the original position.</p> <p>The damage of the terminal shall be visually examined.</p> <p>将本体固定好，施与引线保持水平用如下作用力，先以一方向弯曲 90°，再以反方向弯曲 90° 回复原状。检查铜脚损伤情况。</p> <table border="1"> <thead> <tr> <th>Terminal diameter 引线直径</th> <th>Force 作用力</th> </tr> </thead> <tbody> <tr> <td>Ø 0.6 mm</td> <td>4.9 N (0.5Kgf)</td> </tr> <tr> <td>Ø 0.8 mm</td> <td>4.9 N (0.5Kgf)</td> </tr> <tr> <td>Ø 1.0 mm</td> <td>9.8 N (1.0Kgf)</td> </tr> </tbody> </table> | Terminal diameter 引线直径 | Force 作用力 | Ø 0.6 mm | 4.9 N (0.5Kgf) | Ø 0.8 mm | 4.9 N (0.5Kgf) | Ø 1.0 mm | 9.8 N (1.0Kgf) | No outstanding damage 无外在损伤 |
| Terminal diameter 引线直径 | Force 作用力 | | | | | | | | | |
| Ø 0.6 mm | 4.9 N (0.5Kgf) | | | | | | | | | |
| Ø 0.8 mm | 4.9 N (0.5Kgf) | | | | | | | | | |
| Ø 1.0 mm | 9.8 N (1.0Kgf) | | | | | | | | | |
| Vibration 耐振性 IEC60068-2-6 | <p>After repeatedly applying a single harmonic vibration (amplitude: 0.75 mm) double amplitude:1.5mm with 1 minute vibration frequency cycles (10 Hz to 55 Hz to 10 Hz) to each of three perpendicular directions for 2 hours.</p> <p>Thereafter, the unit shall be visually examined</p> <p>将成品置于振动机上施与一单谐振动（振幅：0.75mm）和振幅 1.5mm，振动频率周期为 10 Hz to 55 Hz to 10 Hz 一分钟，对三个垂直方向各试验 2 小时。然后检查成品外在损伤情况。</p> | | | | | | | | | |
| Solder adilty 焊接性 IEC 60068-2-20 | <p>After dipping the terminals to a depth of approximately 3mm from the body in a soldering bath of 250±5 °C for 2±0.5 seconds, the terminal shall be visually examined.</p> <p>将成品引线部分侵入温度为 260±5 °C 锡炉中，侵入深度为离本体约 3mm 处，时间为 2±0.5 秒。</p> | Approximately 95% of the terminals shall be covered with solder uniformly 引脚约 95% 沾满焊锡 | | | | | | | | |
| Resistance to Soldering Heat 锡热抵抗力 IEC 60068-2-20 | <p>After each lead shall be dipped into a solder bath having a temperature 260±5 °C to a point 2.0 to 2.5 mm from the body of the unit, using shieldig board (t=1.5mm), be held there for specified time (5D series: 5±1s and others: 10±1s), and then be stored at room temperature and humidity for 1 to 2 hours.</p> <p>The change of Vc and mechanical damages are examind.</p> <p>将每一引线侵入温度为 260±5 °C 锡炉中，侵入深度为离本体 2.0-2.5mm，侵入时间 5D 为 5±1s；其它为 10±1s，试验完后置于常温常湿中 1-2 小时，然后测量压敏电压变化量与外观。</p> | $\Delta V_{cmA}/V_{cmA} \leq \pm 5\%$ No outstanding damage 无外在损伤 | | | | | | | | |



ZINC OXIDE VARISTOR

Environmental 环境特性

| Test Item/Standard 测试项目/标准 | Test Methods 测试方法 | Specifications 规格值 | | | | | | | | | | | | | | |
|---|--|--|------|-----------------|------------------|---|-------------|------------|---|------------------|------------|---|-------------|------------|---|------------------|
| High Temperature Storage/Dry Heat 高温储存 IEC 60068-2-2 | The specimen shall be subjected to 125 ± 2 °C for 1000 hours in a thermostatic bath without load and then stored at room temperature and humidity for 1 to 2 hours. Thereafter, the change of V_c shall be measured. 将成品置于无外加负载且温度为 125 ± 2 °C 的烤箱中 1000 小时，试验后置于室温中 1-2 小时，然后测量其压敏电压变化值。 | $\Delta V_{cmA}/V_{cmA} \leq \pm 5\%$ | | | | | | | | | | | | | | |
| Damp Heat/ Humidity (Steady State) 耐湿性 IEC 60068-2-78 | The specimen shall be subjected to 40 ± 2 °C, 90 to 95 %RH for 1000 hours without load and then stored at room temperature and humidity for one to two hours. Thereafter, the change of V_c shall be measured. 将成品置于无外加负载且温度为 40 ± 2 °C，相对湿度为 90-95% 恒温恒湿相中 1000 小时，试验后置于室温中 1-2 小时，然后测量其压敏电压变化值。 | | | | | | | | | | | | | | | |
| Temperature Cycle 温度周期 IEC 60068-2-14 | The temperature cycle shown below shall be repeated five times and then stored at room temperature and humidity for one to two hours. The change of V_c and mechanical damage shall be examined. 以如下表的温度周期加于成品上五次，试验后置于室温中 1-2 小时，然后测量其压敏电压变化值。 <table border="1" style="margin-left: auto; margin-right: auto;"> <thead> <tr> <th>Step</th> <th>Temperature(°C)</th> <th>Period (minutes)</th> </tr> </thead> <tbody> <tr> <td>1</td> <td>-40 ± 3</td> <td>30 ± 3</td> </tr> <tr> <td>2</td> <td>Room temperature</td> <td>15 ± 3</td> </tr> <tr> <td>3</td> <td>125 ± 2</td> <td>30 ± 3</td> </tr> <tr> <td>4</td> <td>Room temperature</td> <td>15 ± 3</td> </tr> </tbody> </table> | | Step | Temperature(°C) | Period (minutes) | 1 | -40 ± 3 | 30 ± 3 | 2 | Room temperature | 15 ± 3 | 3 | 125 ± 2 | 30 ± 3 | 4 | Room temperature |
| Step | Temperature(°C) | Period (minutes) | | | | | | | | | | | | | | |
| 1 | -40 ± 3 | 30 ± 3 | | | | | | | | | | | | | | |
| 2 | Room temperature | 15 ± 3 | | | | | | | | | | | | | | |
| 3 | 125 ± 2 | 30 ± 3 | | | | | | | | | | | | | | |
| 4 | Room temperature | 15 ± 3 | | | | | | | | | | | | | | |
| High Temperature Load/Dry Heat Load 高温加载 MIL-STD-202-Method-108 | After being continuously applied the Maximum Allowable Voltage at 85 ± 2 °C for 1000 hours. The specimen shall be stored at room temperature and humidity for one to two hours. Thereafter, the change of V_c shall be measured. 将成品接于外加最大容许电压且温度为 85 ± 2 °C 的高温箱中 1000 小时，试验后置于室温中 1-2 小时，然后测量其压敏电压变化值。 | $\Delta V_{cmA}/V_{cmA} \leq \pm 10\%$ | | | | | | | | | | | | | | |
| Damp Heat Load/ Humidity Load 高湿加载 IEC 60068-2-3 | The specimen shall be subjected to 40 ± 2 °C, 90 to 95 %RH and the Maximum Allowable Voltage for 1000 hours and then stored at room temperature and humidity for one to two hours. Thereafter, the change of V_c shall be measured. 将成品接于外加最大容许电压且温度为 40 ± 2 °C，相对湿度为 90-95% 恒温恒湿箱中 1000 小时，试验后置于室温中 1-2 小时，然后测量其压敏电压变化值。 | $\Delta V_{cmA}/V_{cmA} \leq \pm 10\%$ | | | | | | | | | | | | | | |



ZINC OXIDE VARISTOR

Current Energy and Power Derating Curve 电流、能量、功率递减曲线

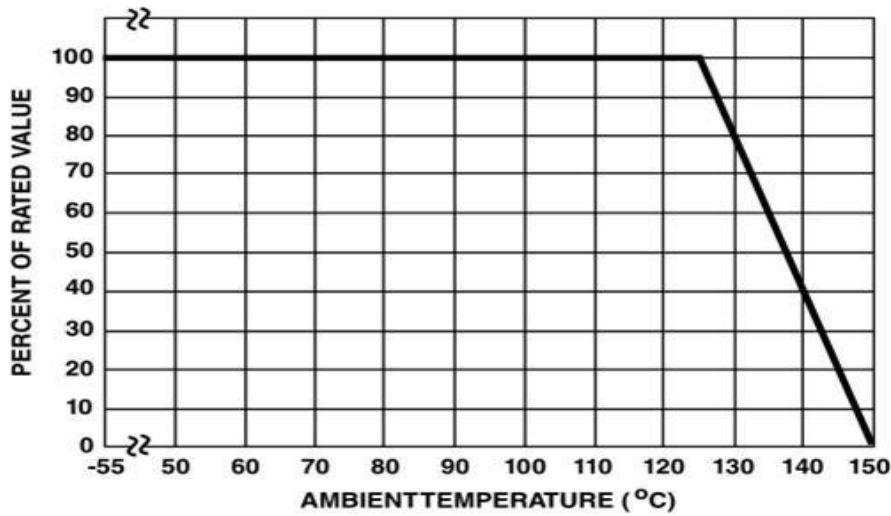

(图 1: 电流、能量、功率递减曲线)

Soldering Recommendation Profile 推荐焊接条件

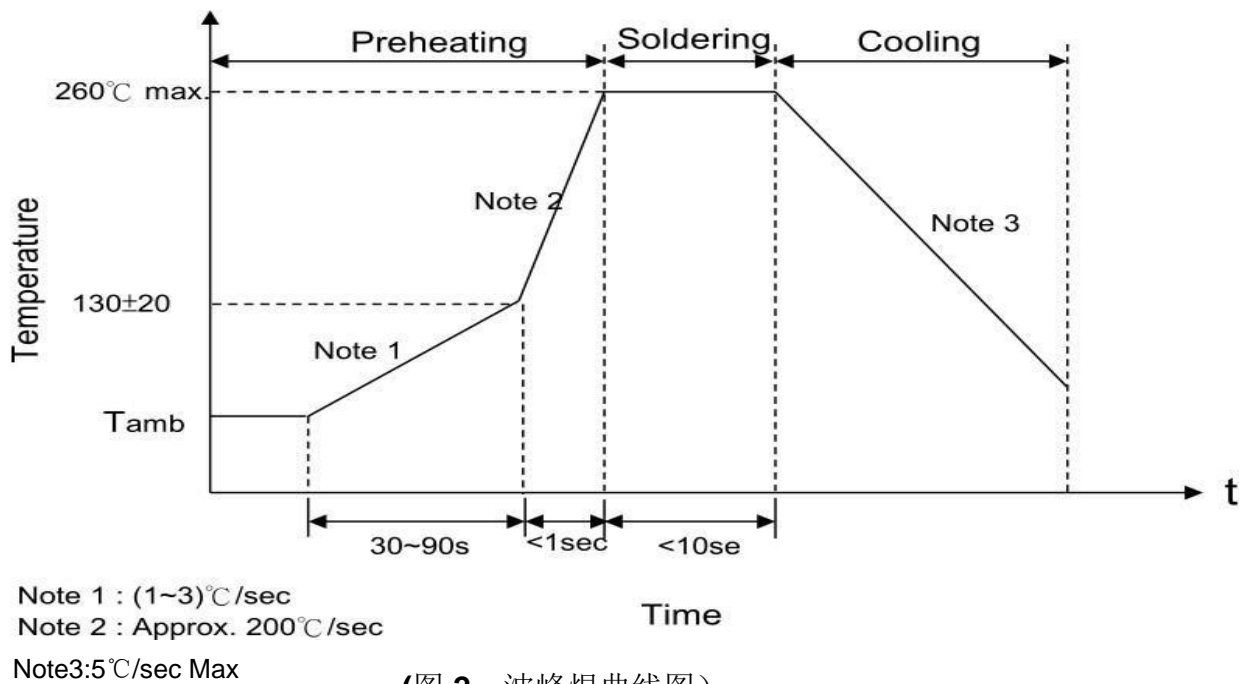

(图 2: 波峰焊曲线图)

Recommendation Reworking Conditions with Soldering Iron 烙铁重工焊接条件

| 项目 | 条件 |
|------------|--------------|
| 烙铁头部温度 | 360°C (max.) |
| 焊接时间 | 3 sec (max.) |
| 焊接位置与涂装层距离 | 2 mm (min.) |



ZINC OXIDE VARISTOR

Impulse Life Time Rating Curves 额定脉冲寿命次曲线

COV-05D Series

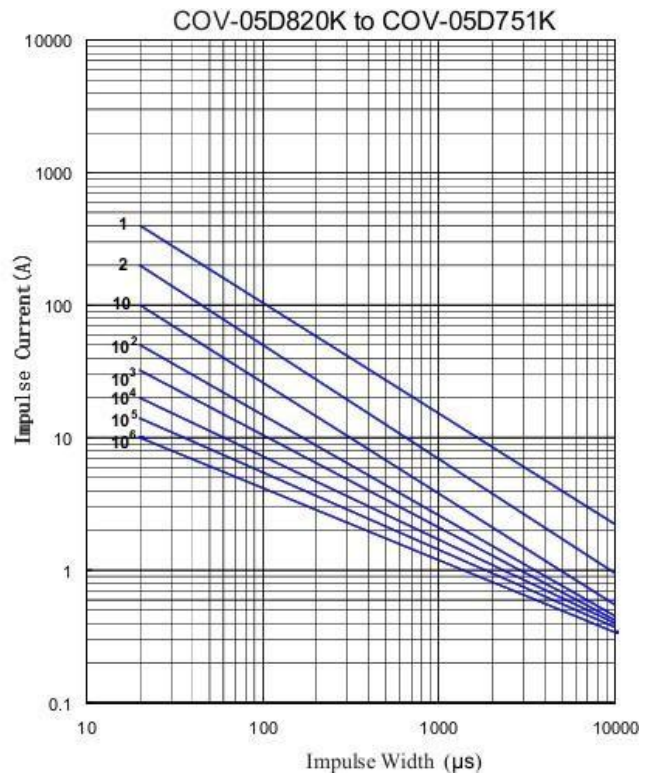
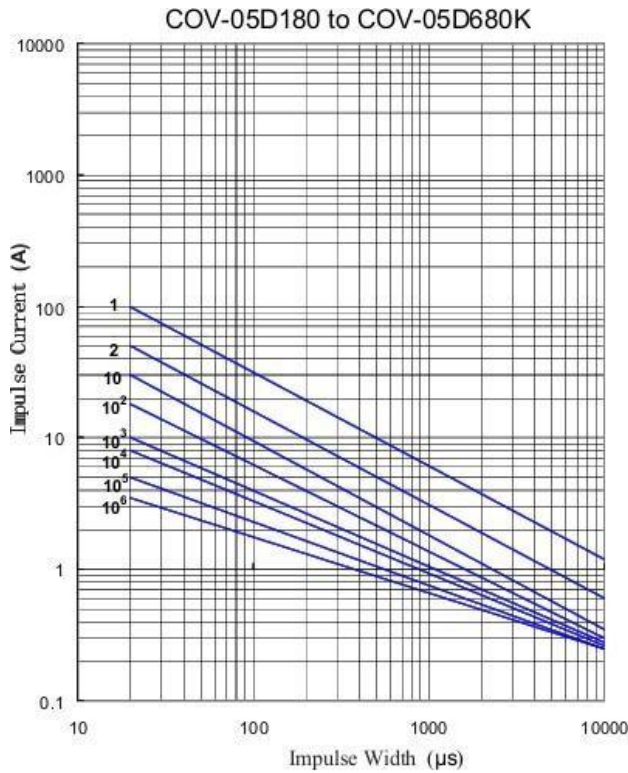

COV-07D Series

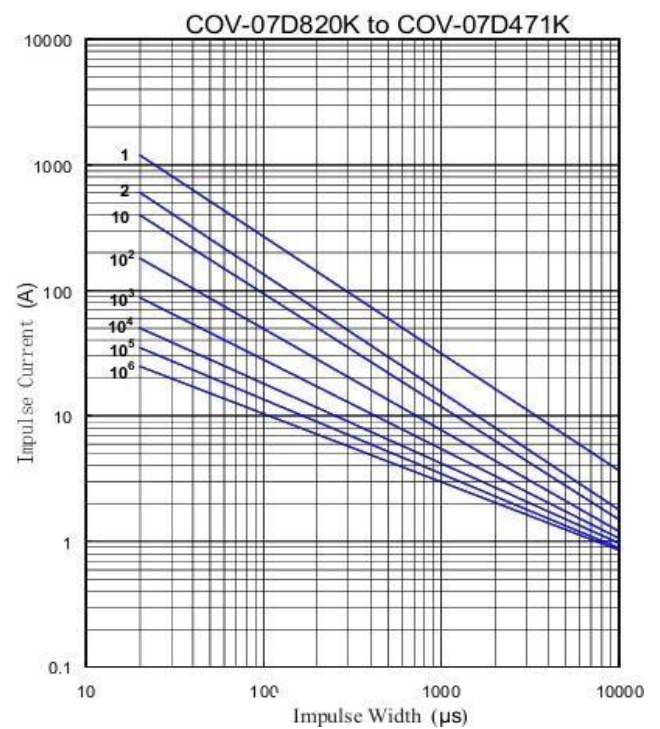
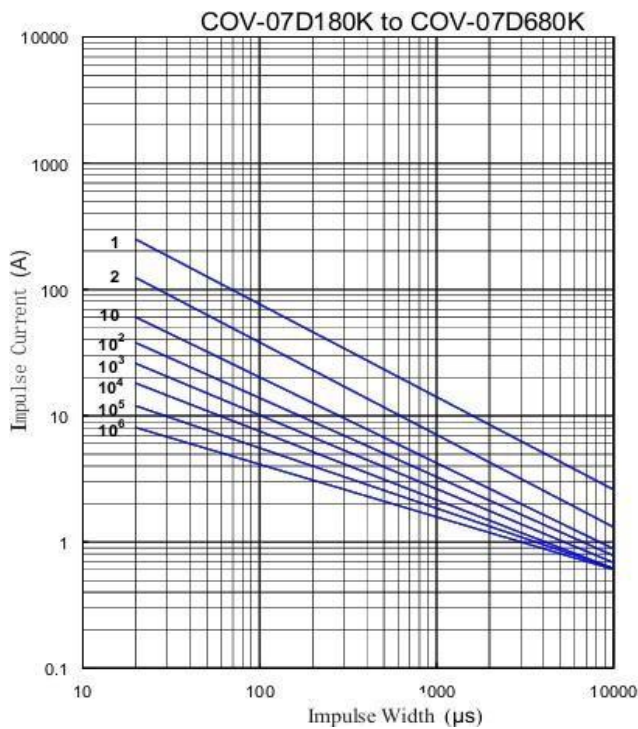

5minutes interval :2times ; 2minutes interval up to :10times ;10secondes interval up to 10⁶times

COV-07D Series

COV-10D Series



ZINC OXIDE VARISTOR

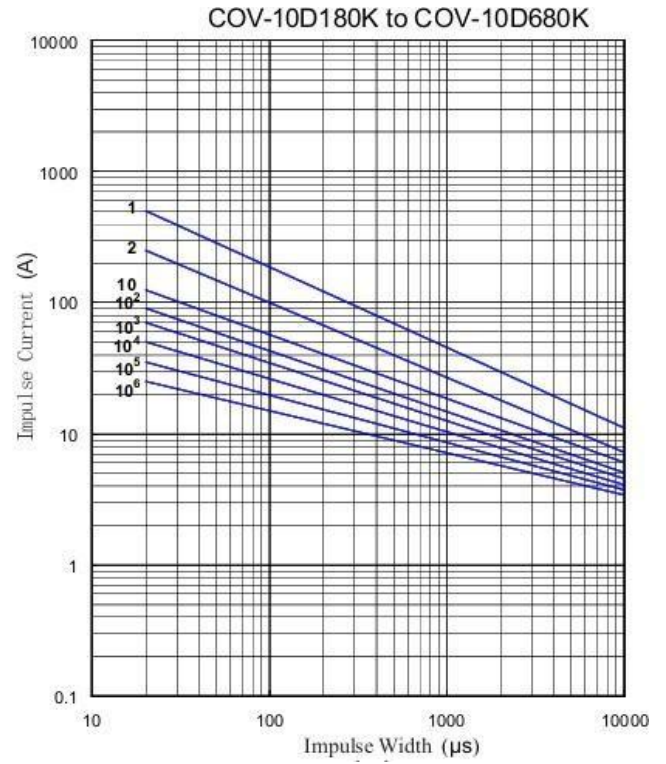
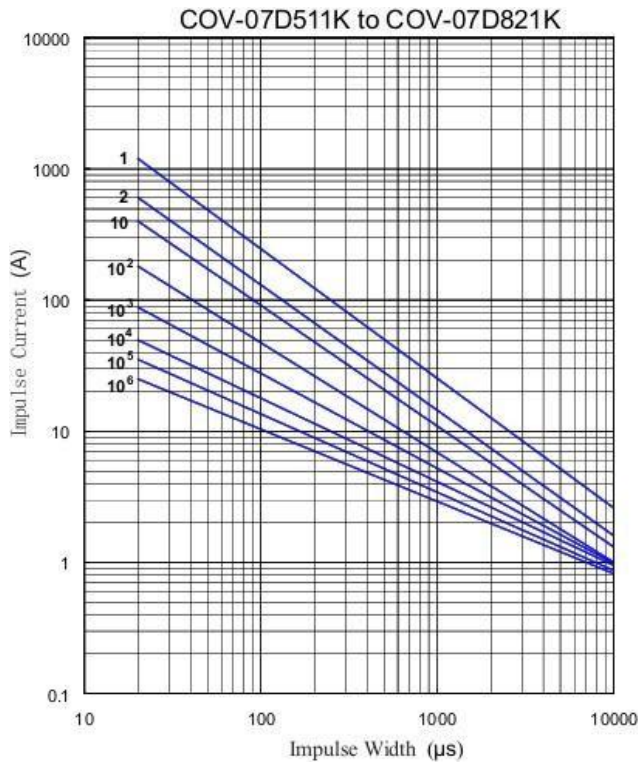

COV-10D Series

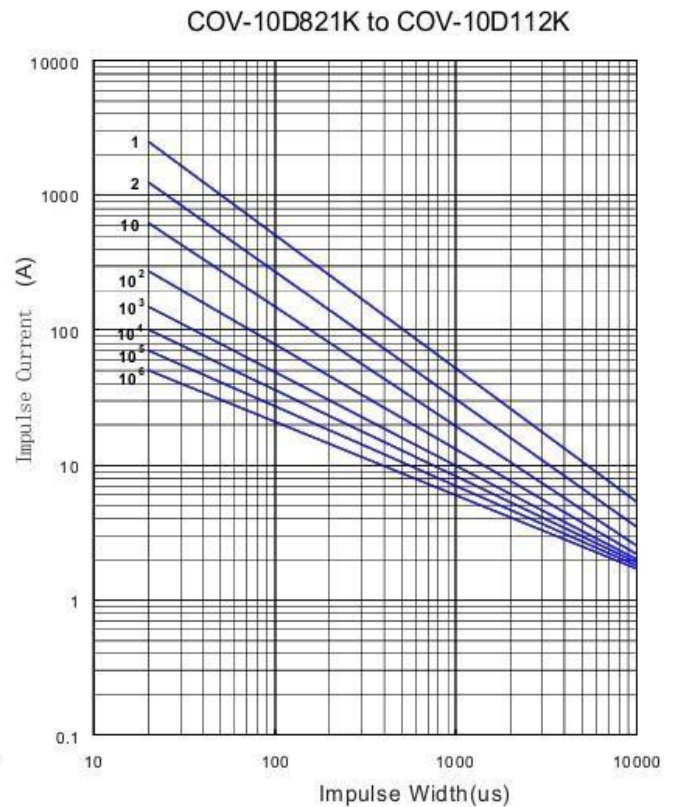
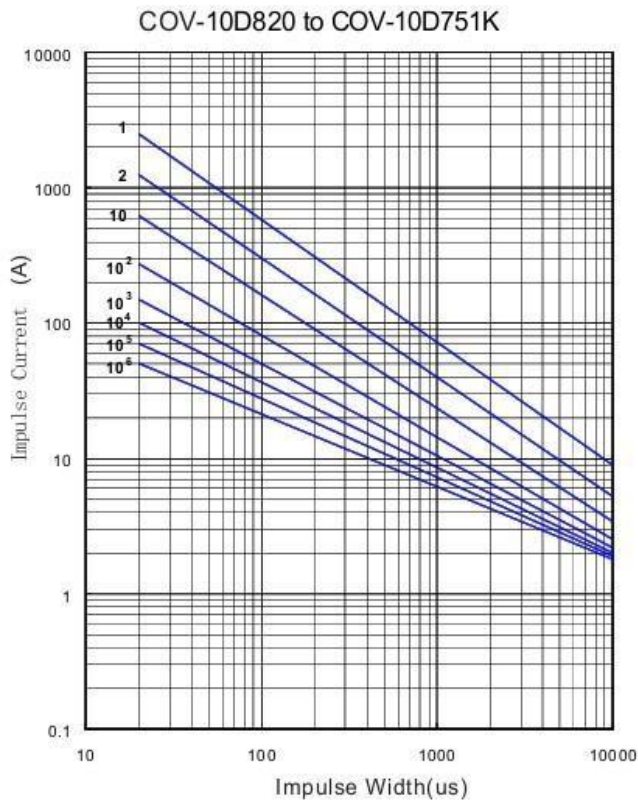

5minutes interval :2times ; 2minutes interval up to :10times ;10secondes interval up to 10⁶times

COV-14D Series

COV-14D Series



ZINC OXIDE VARISTOR

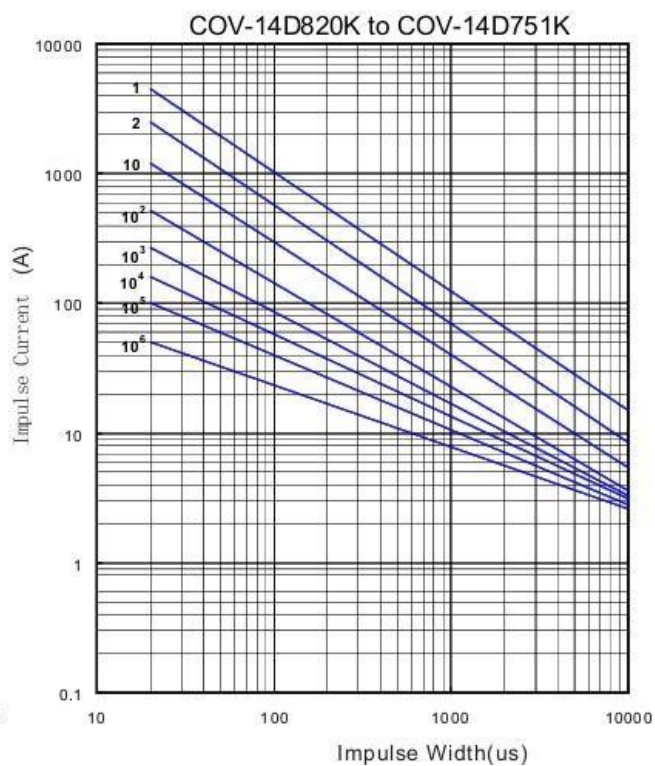
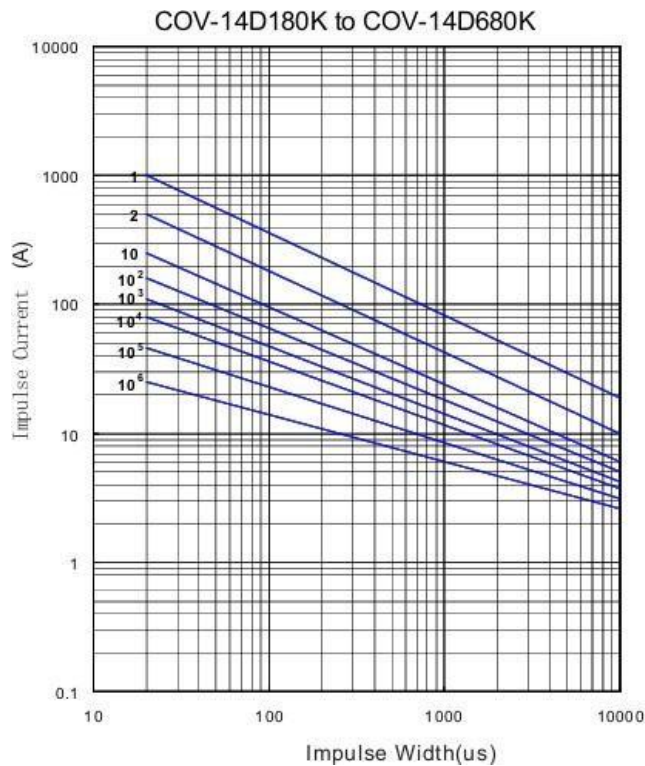

COV-20D Series

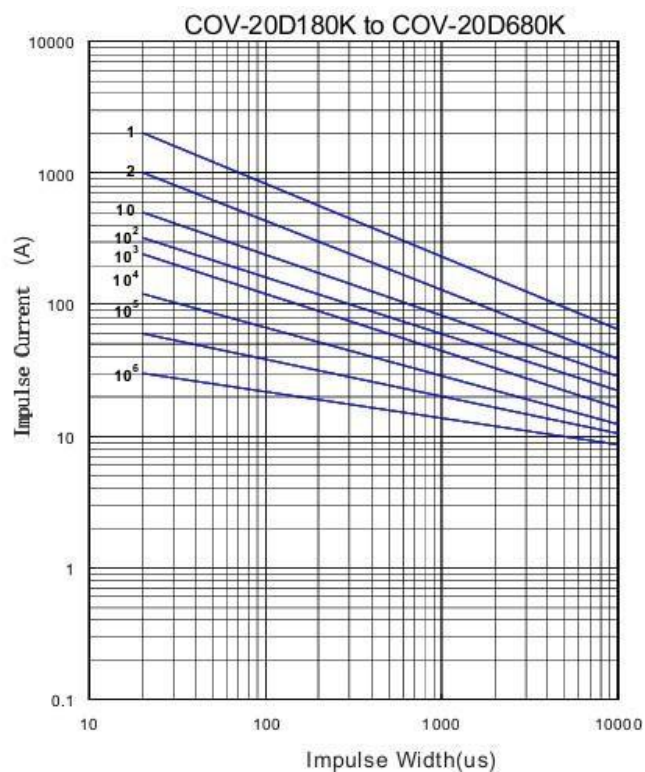
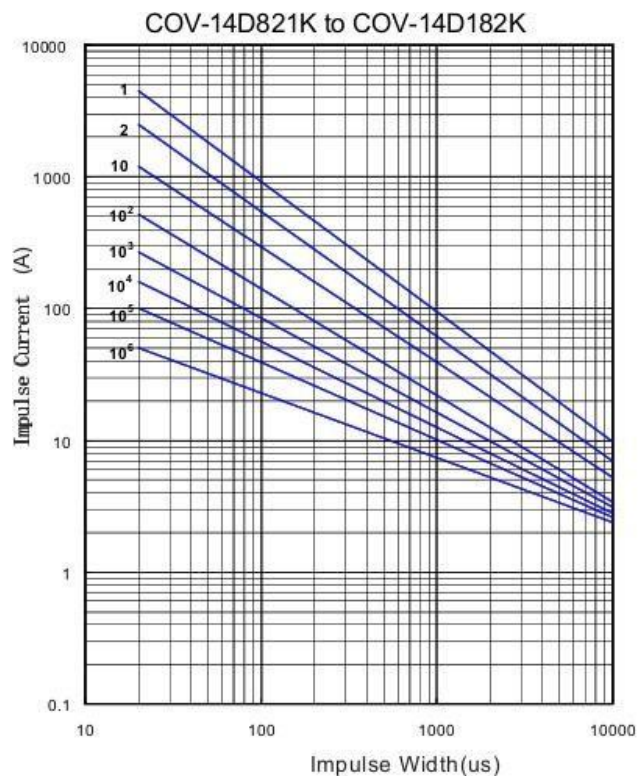

5minutes interval :2times ; 2minutes interval up to :10times ;10secondes interval up to 10^6 times
COV-20D Series



ZINC OXIDE VARISTOR

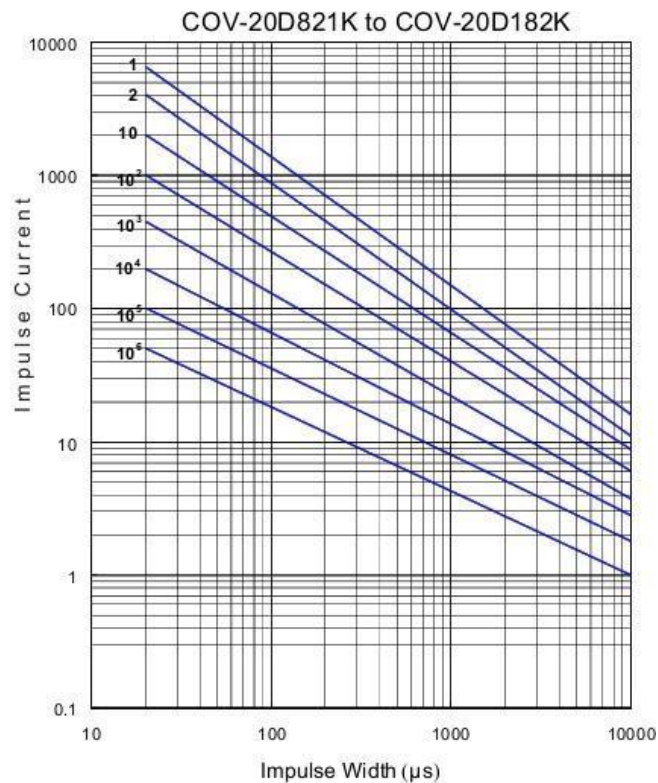
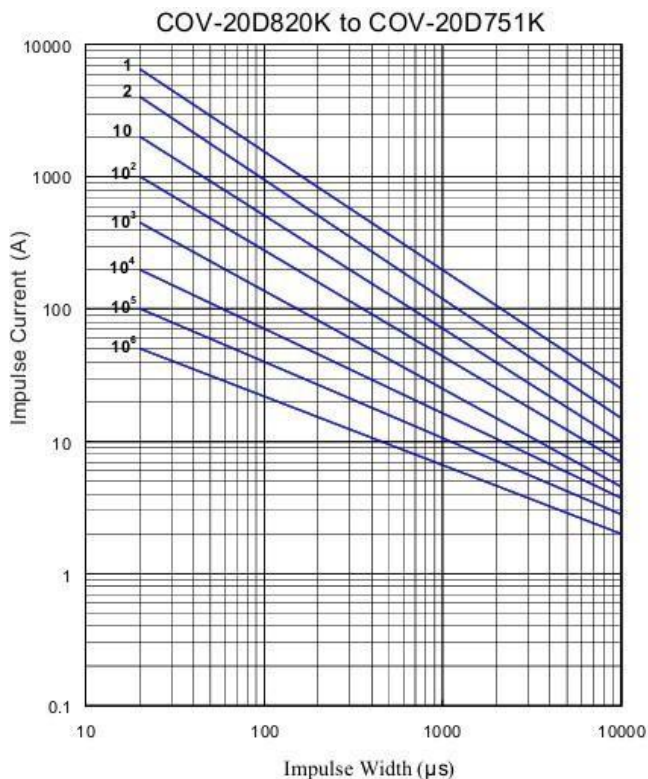

5minutes interval :2times ; 2minutes interval up to :10times ;10secondes interval up to 10^6 times

V-I Curve 电流电压特性曲线

V-I Curve (COV05D180K to COV05D680K)

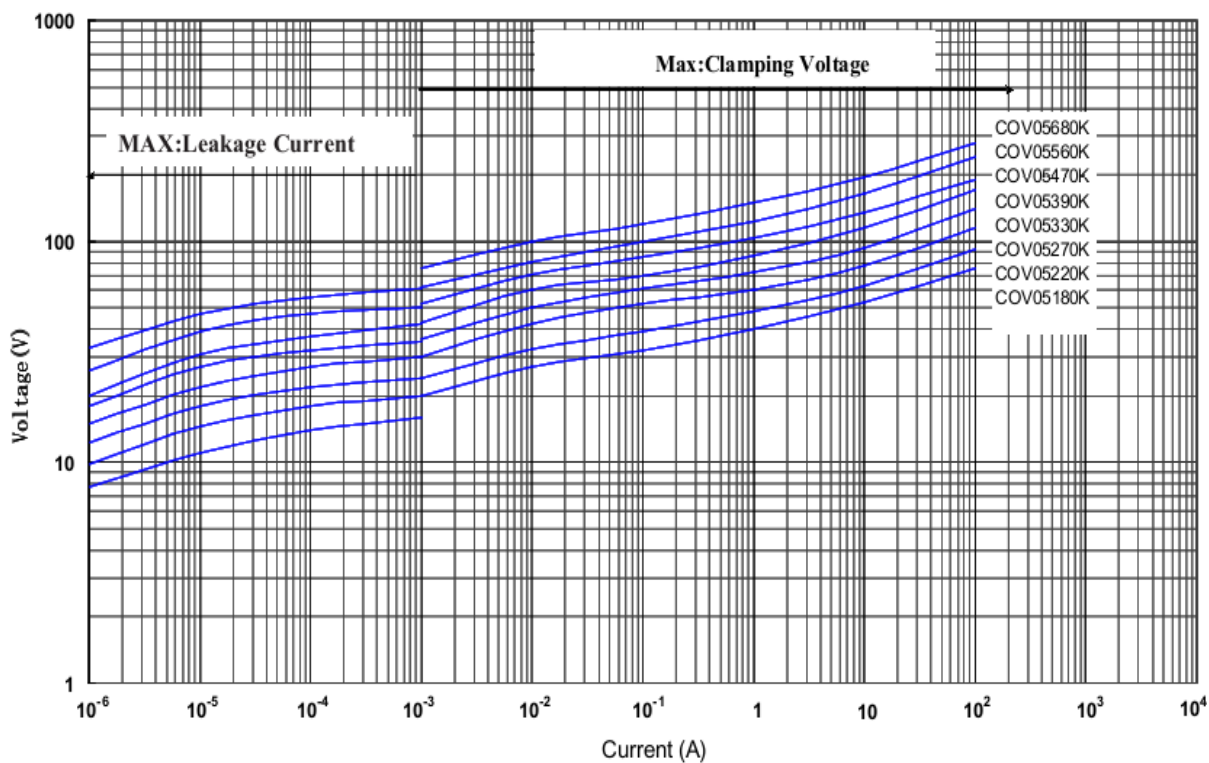



ZINC OXIDE VARISTOR

V-I Curve (COV05D820K to COV05D751K)

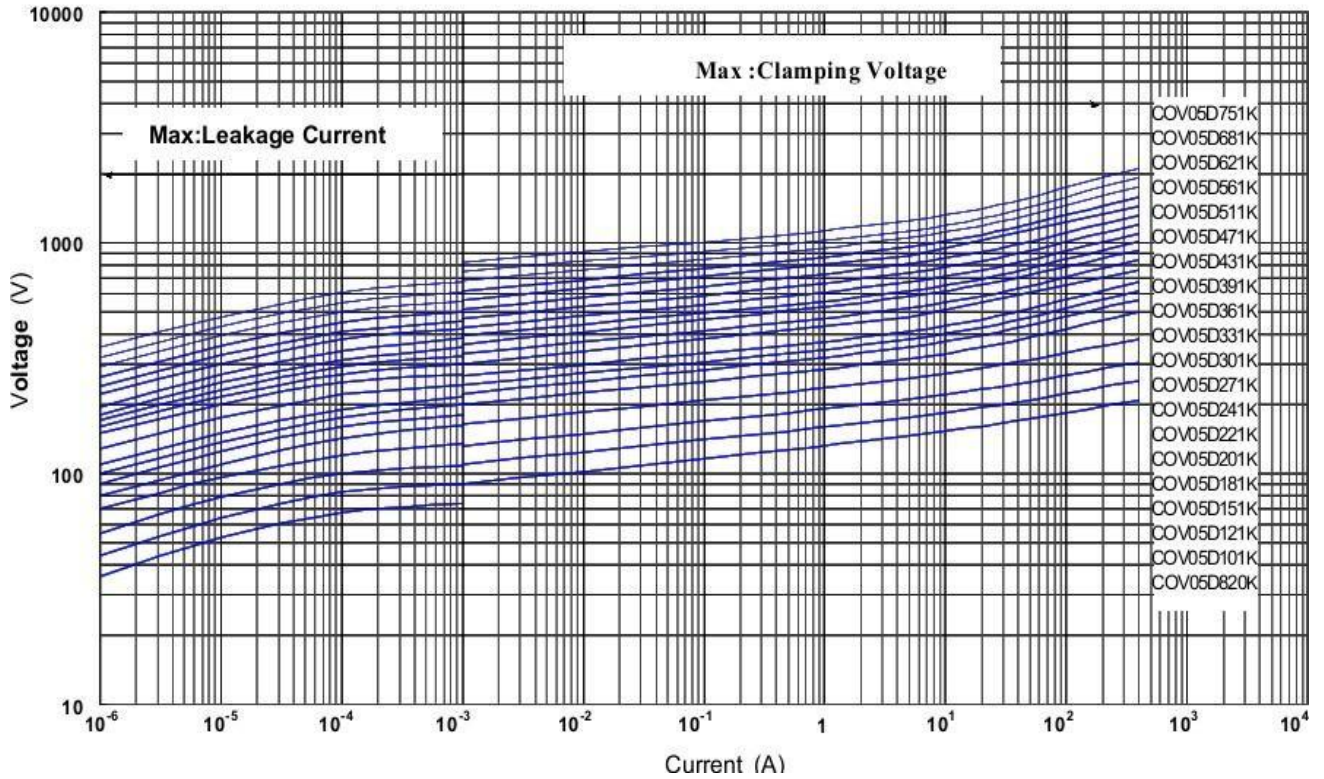

V-I Curve (COV07D180K to COV07D680K)

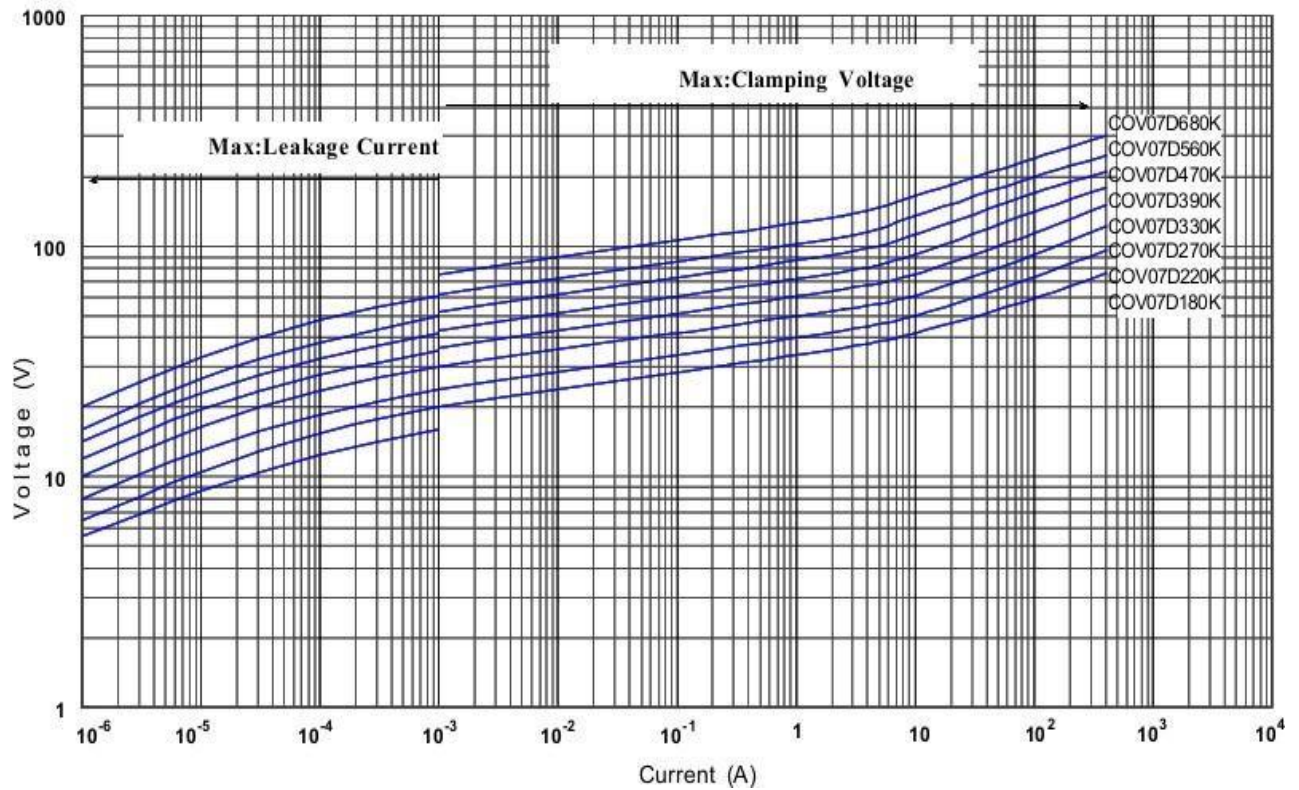



ZINC OXIDE VARISTOR

V-I Curve (COV07D820K to COV07D471K)

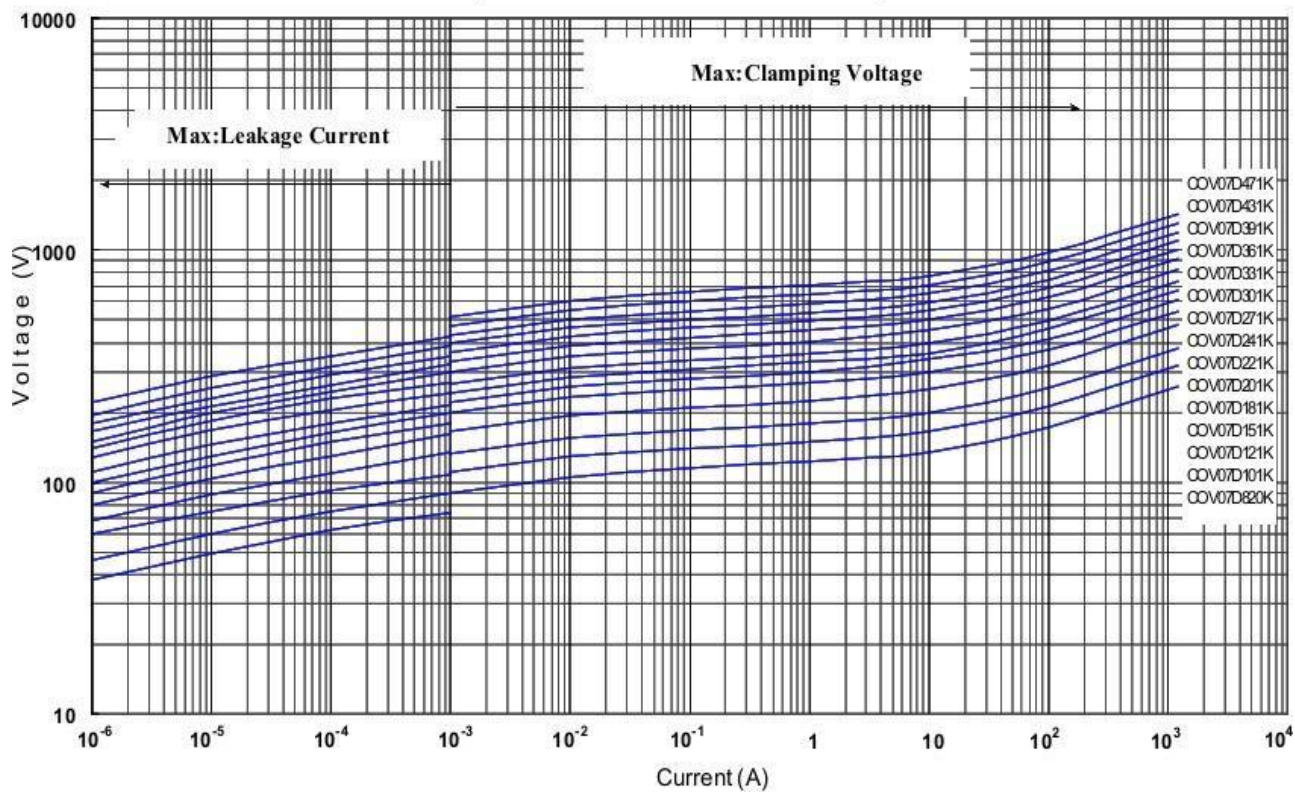

V-I Curve (COV07D511K to COV07D821K)

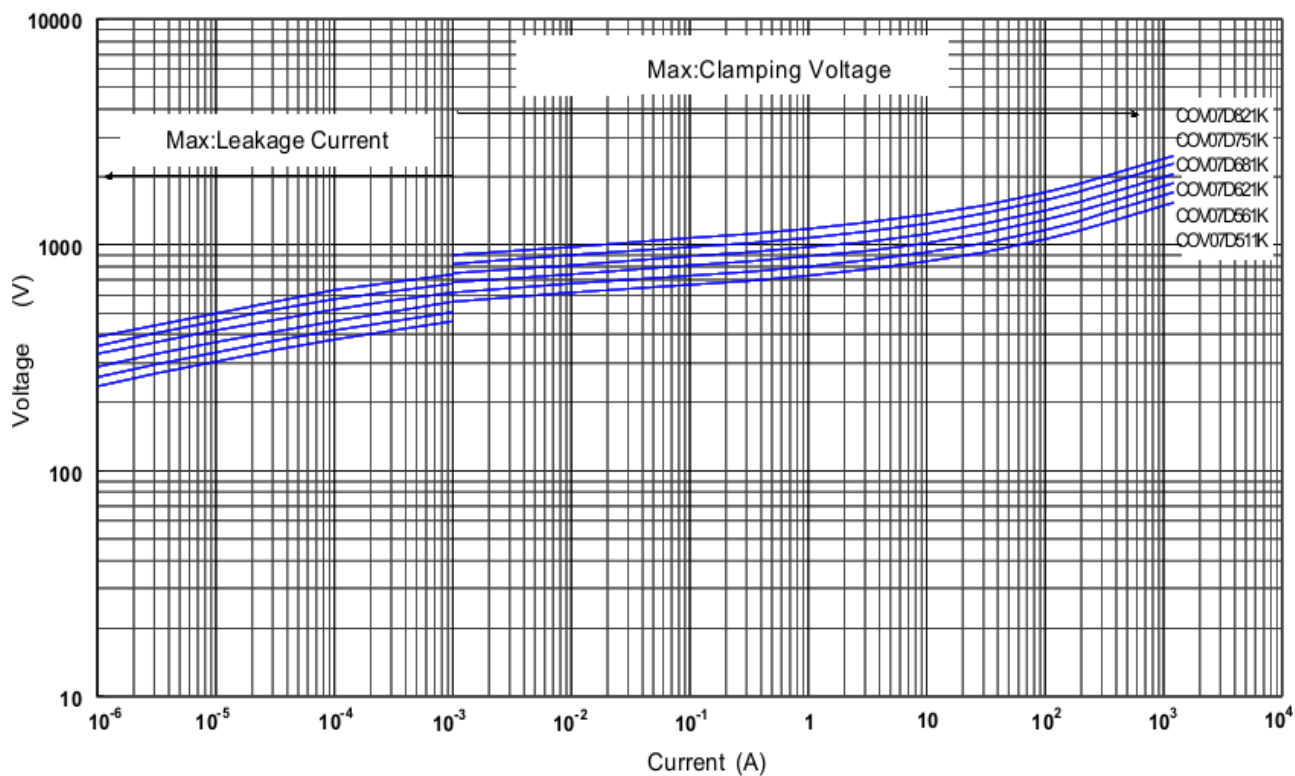



ZINC OXIDE VARISTOR

V-I Curve (COV10D180K to COV10D680K)

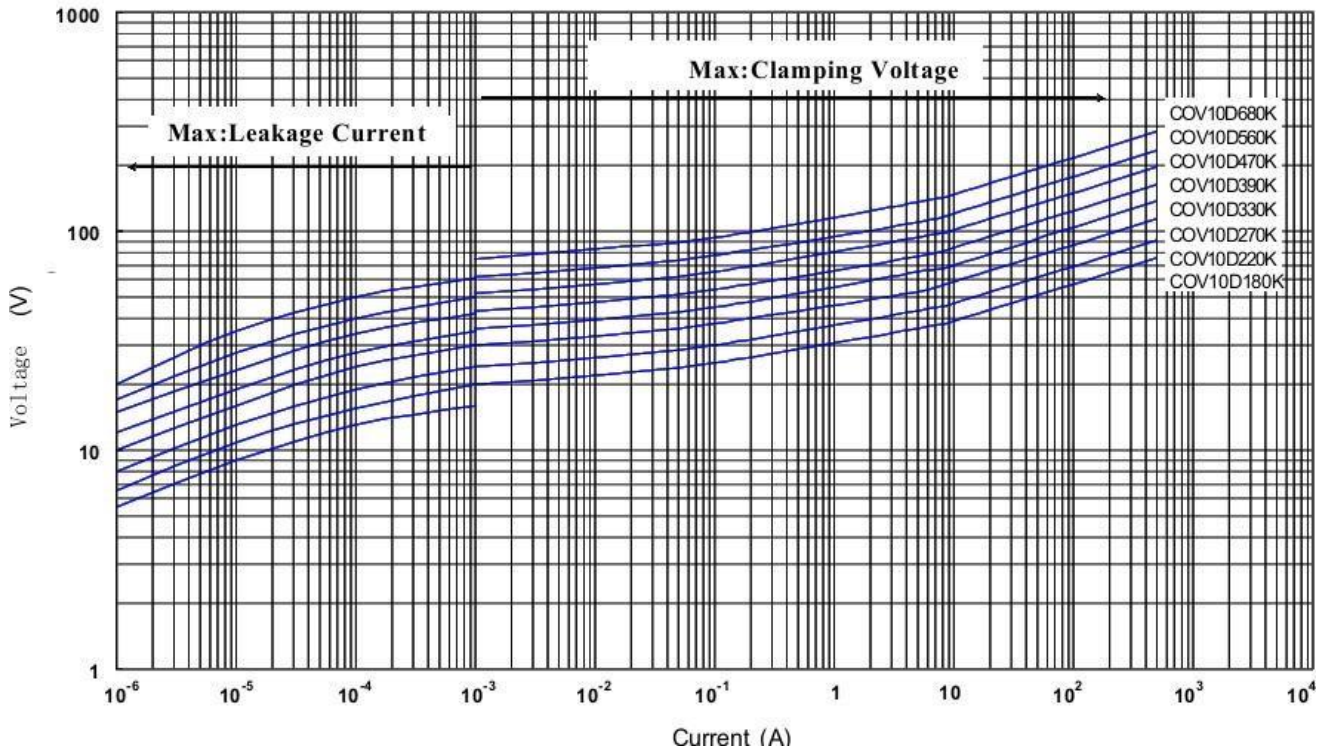

V-I Current (COV10D820K to COV10D471K)

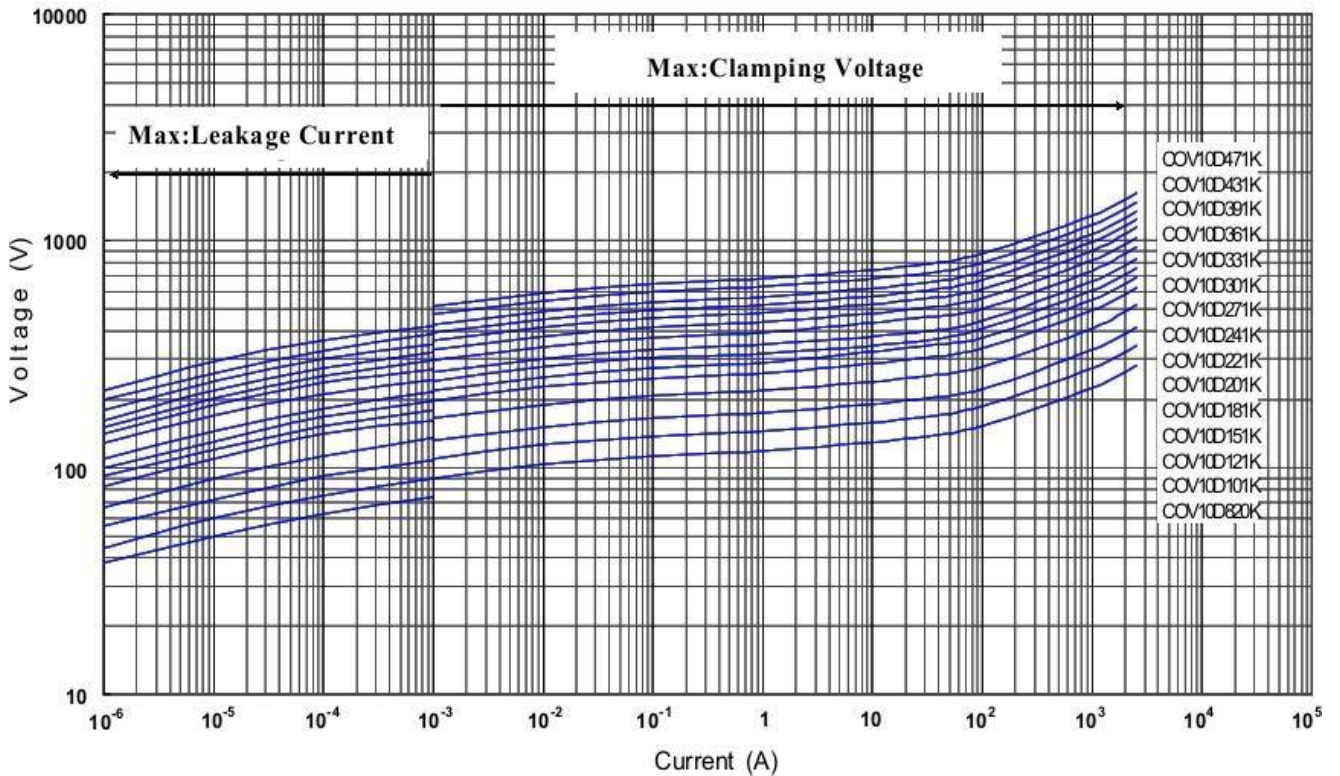



ZINC OXIDE VARISTOR

V-I Curve (COV10D511K to COV10D112K)

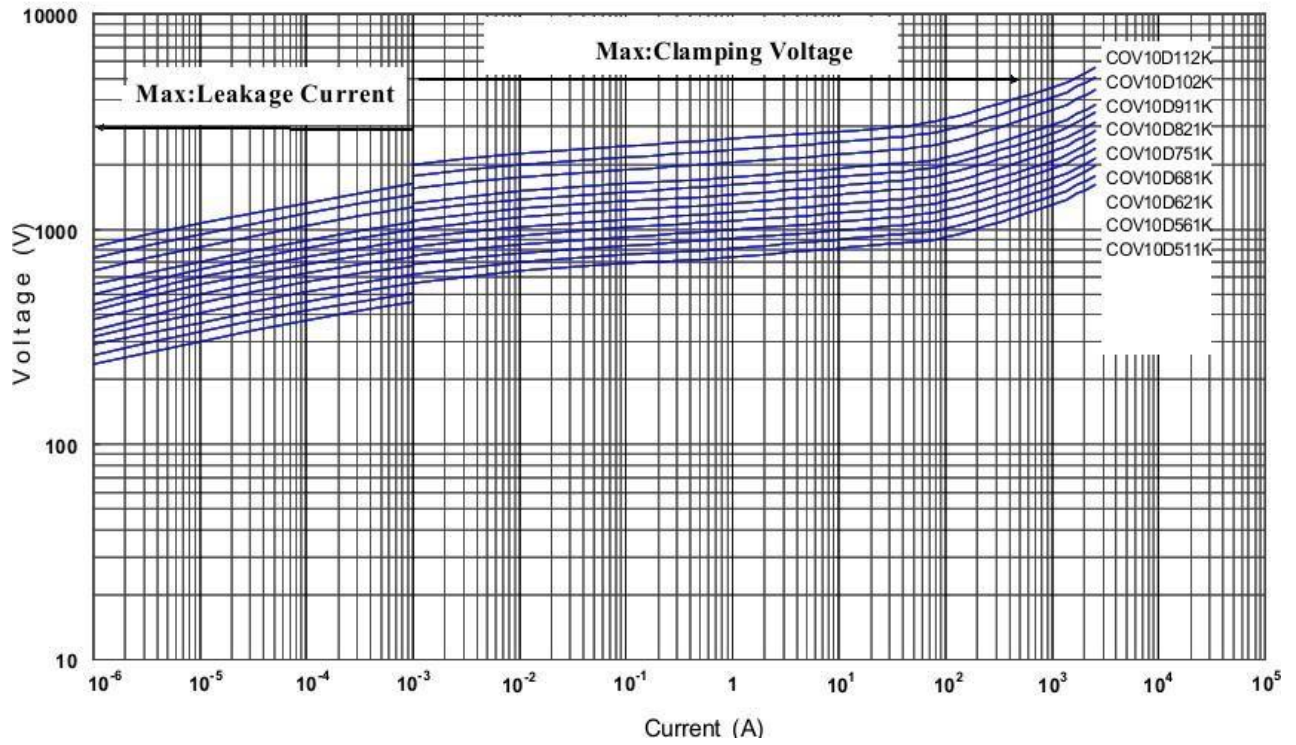

V-I Curve (COV14D180K to COV14D680K)

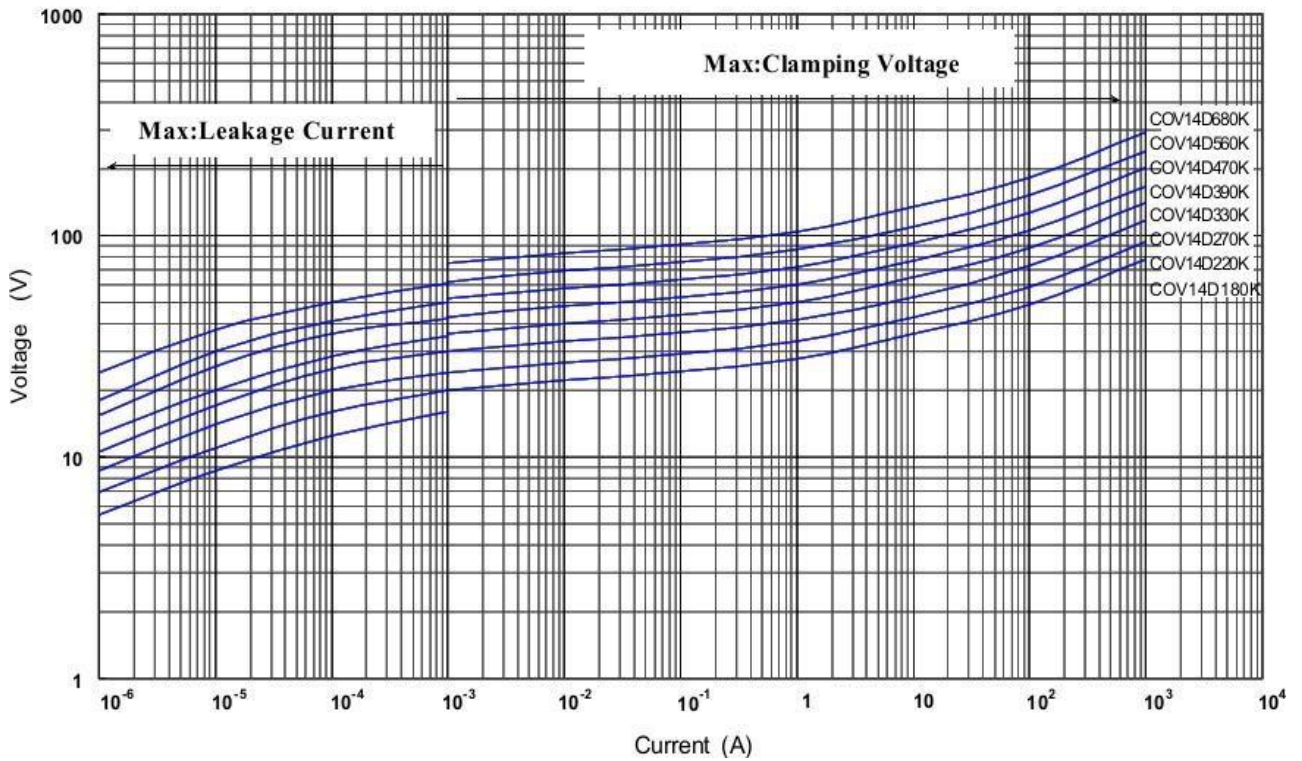



ZINC OXIDE VARISTOR

V-I (COV14D820K to COV14D471K)

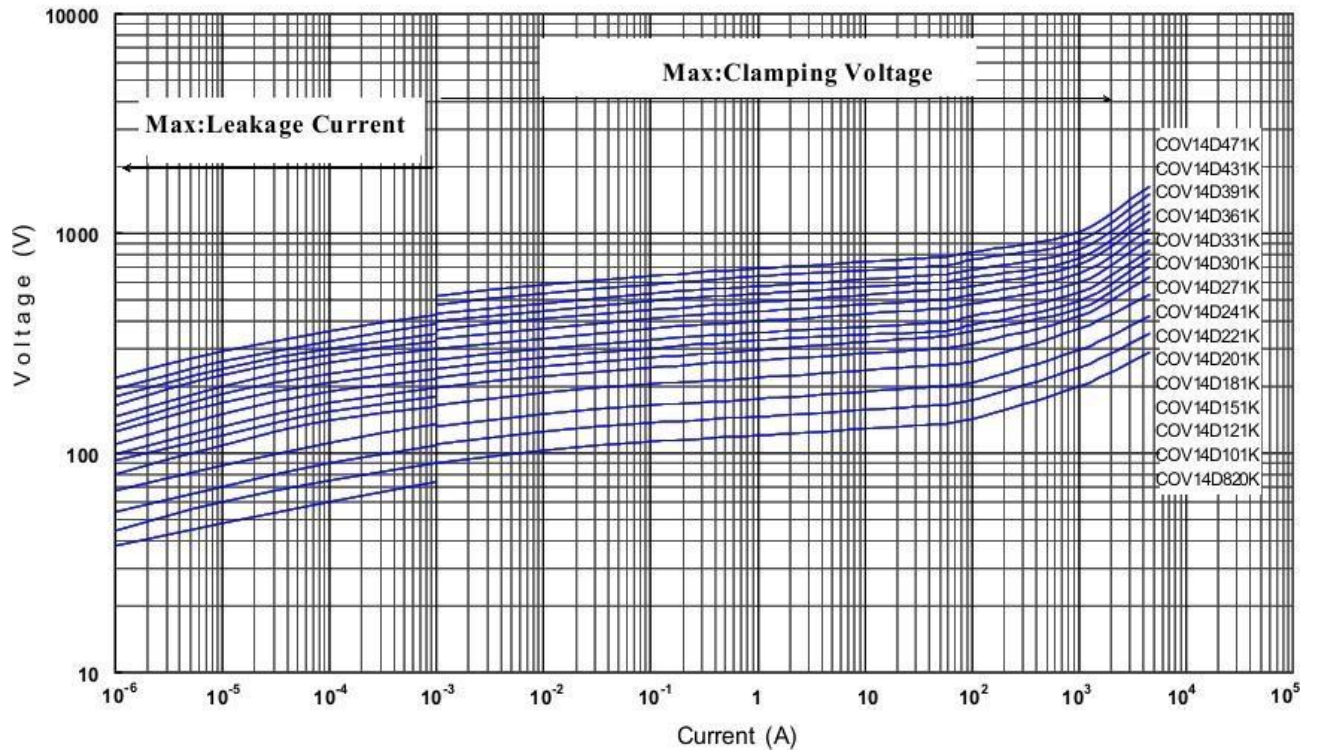

V-I (COV14D511K to COV14D182K)

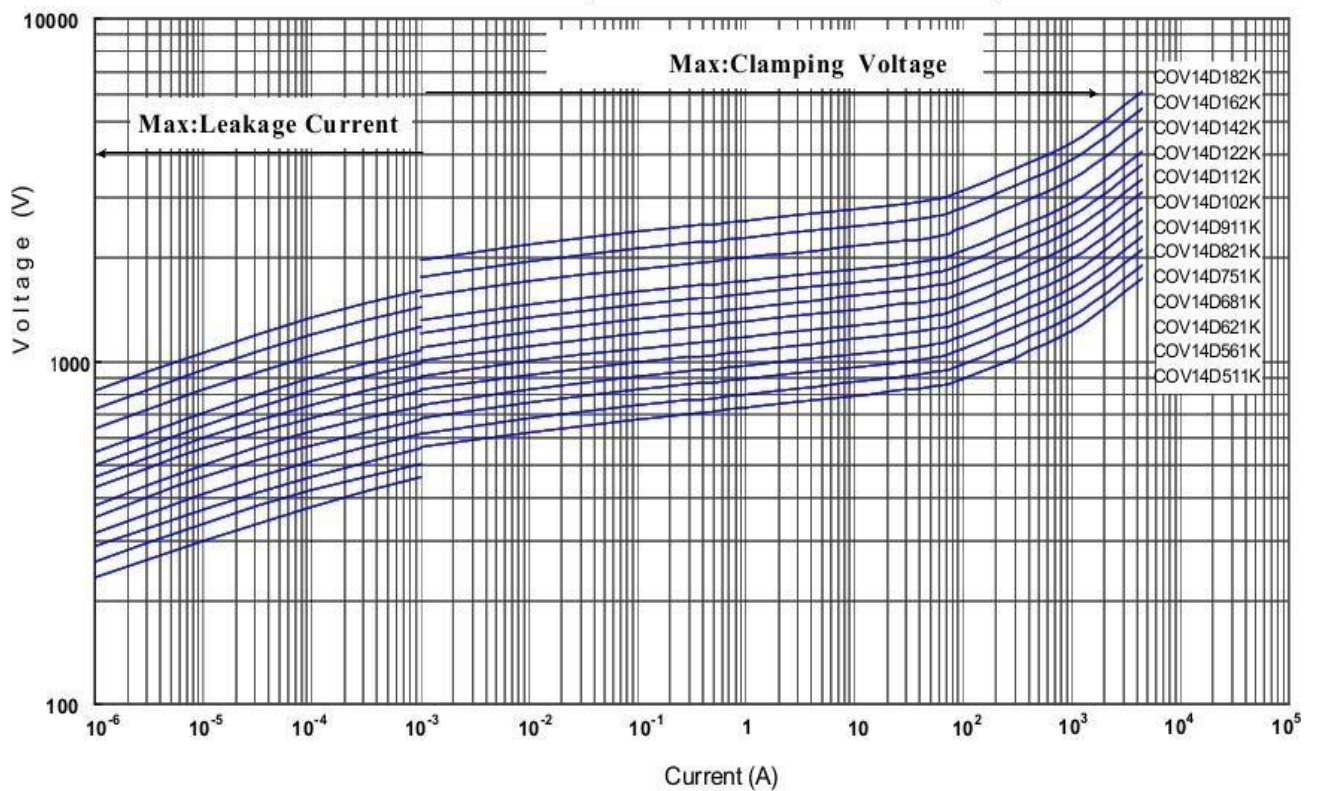



ZINC OXIDE VARISTOR

V - I (COV20D180K to COV20D680K)

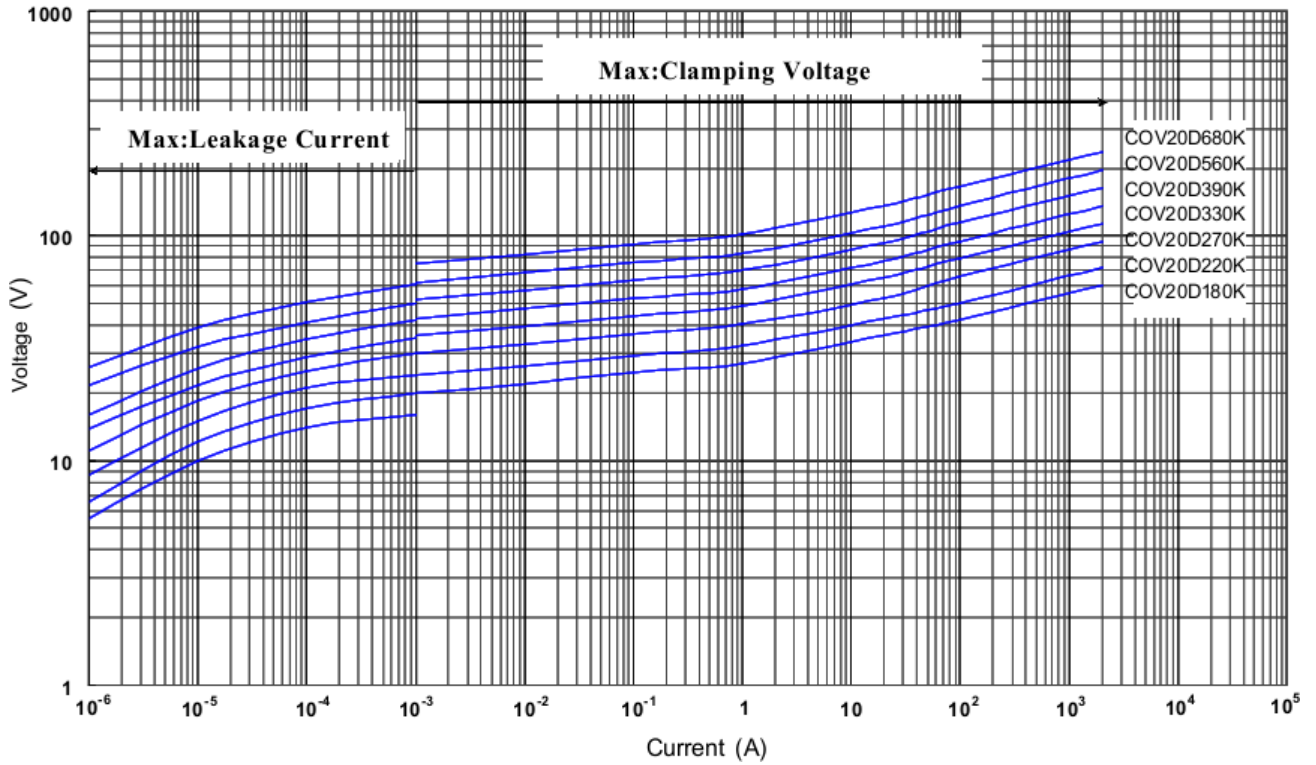

V-I (COV20D820K to COV20D471K)

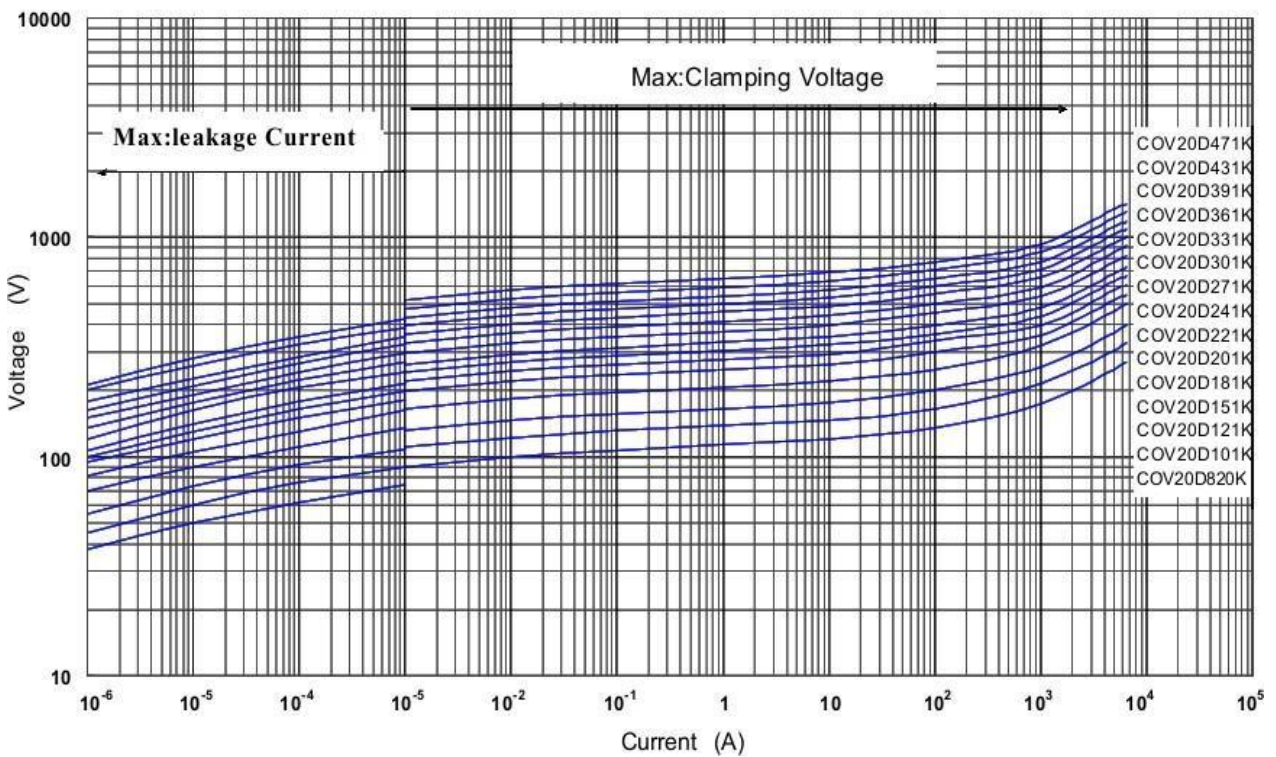



ZINC OXIDE VARISTOR

V - I (COV20D511K to COV20D182K)

