

REV.	ECR/N NO./DESCRIPTION	DATE	DRAWN	CHECKED	APPROVE
8	SN13155	08/29'13	SKY	Vito	Barney
8A	SN130**	11/22'13	SKY	Vito	Barney
8B	SN150**	06/24'15	Vito		Barney

NOTES:

1. MATERIAL:

- 1). HOUSING: LCP, UL-94V0, BLACK.
- 2). COVER: LCP, UL-94V0, BLACK.
- 3). CONTACT: Phosphor Bronze.

2. FINISH: SEE TABLE

3. RoHS COMPLIANT. HF COMPLIANT

4. ELECTRICAL PERFORMANCE

- Contact resistance: 30mΩ MAX.
- Insulation resistance: 1000MΩ MIN

5. MECHANICAL PERFORMANCE

- Durability: 25 cycles

6. IR REFLOW TEMPERATURE: 260°C +/- 5 °C FOR 10 SECONDS MAX.

7. PRODUCT NUMBER NOTE:

ACA-SPI-***-***

- _____ TYPE SERIAL NUMBER
- _____ K: LEAD FREE/P: HALOGEN FREE
- _____ PRODUCT SERIAL NUMBER
- _____ PRODUCT TYPE
- _____ FINISHED PRODUCT
- _____ WAFER CONNECTOR
- _____ CONNECTOR

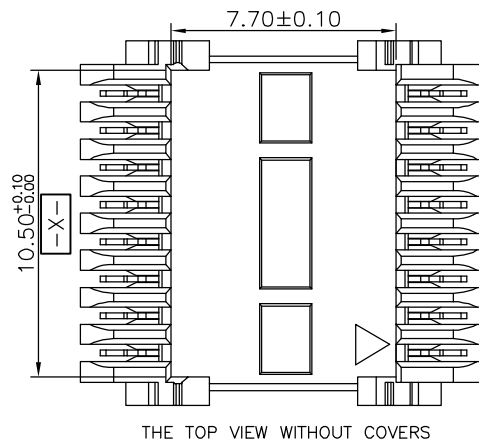
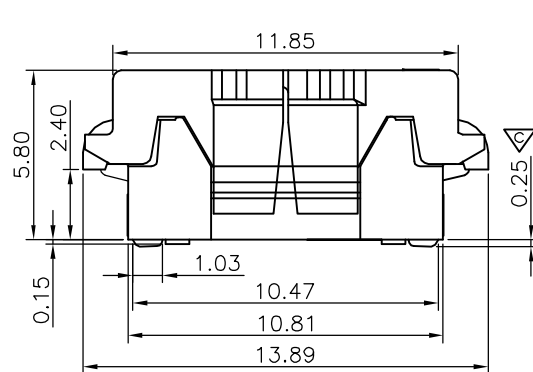
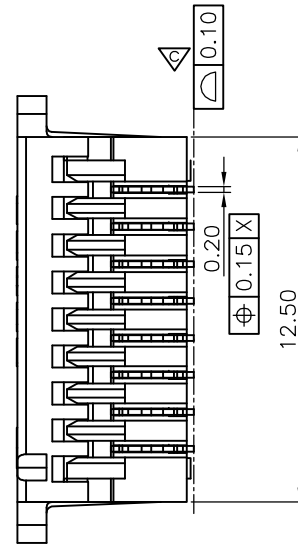
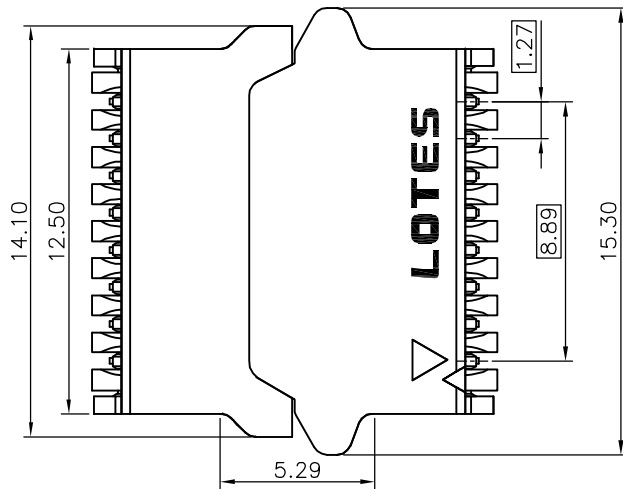
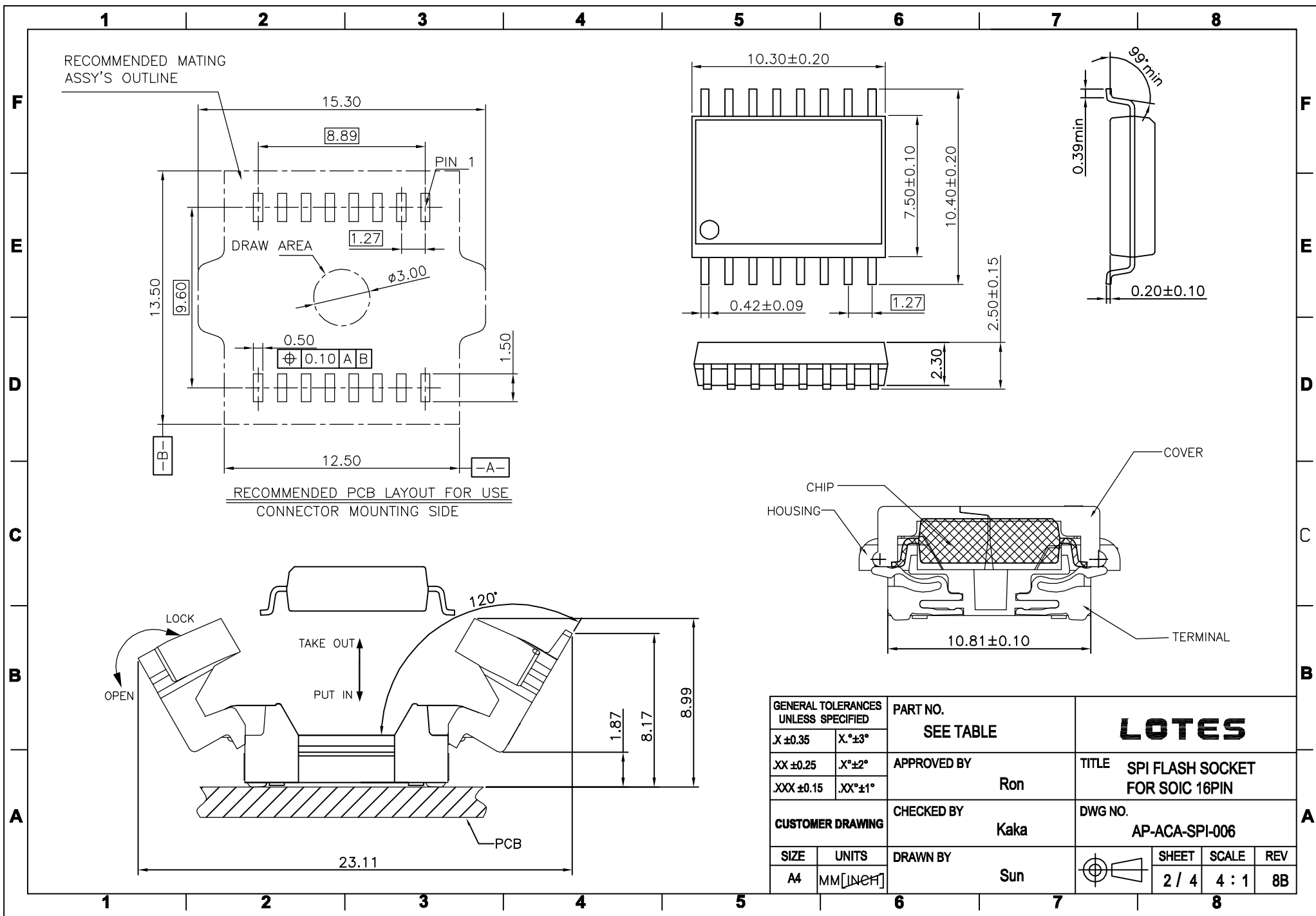
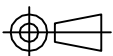
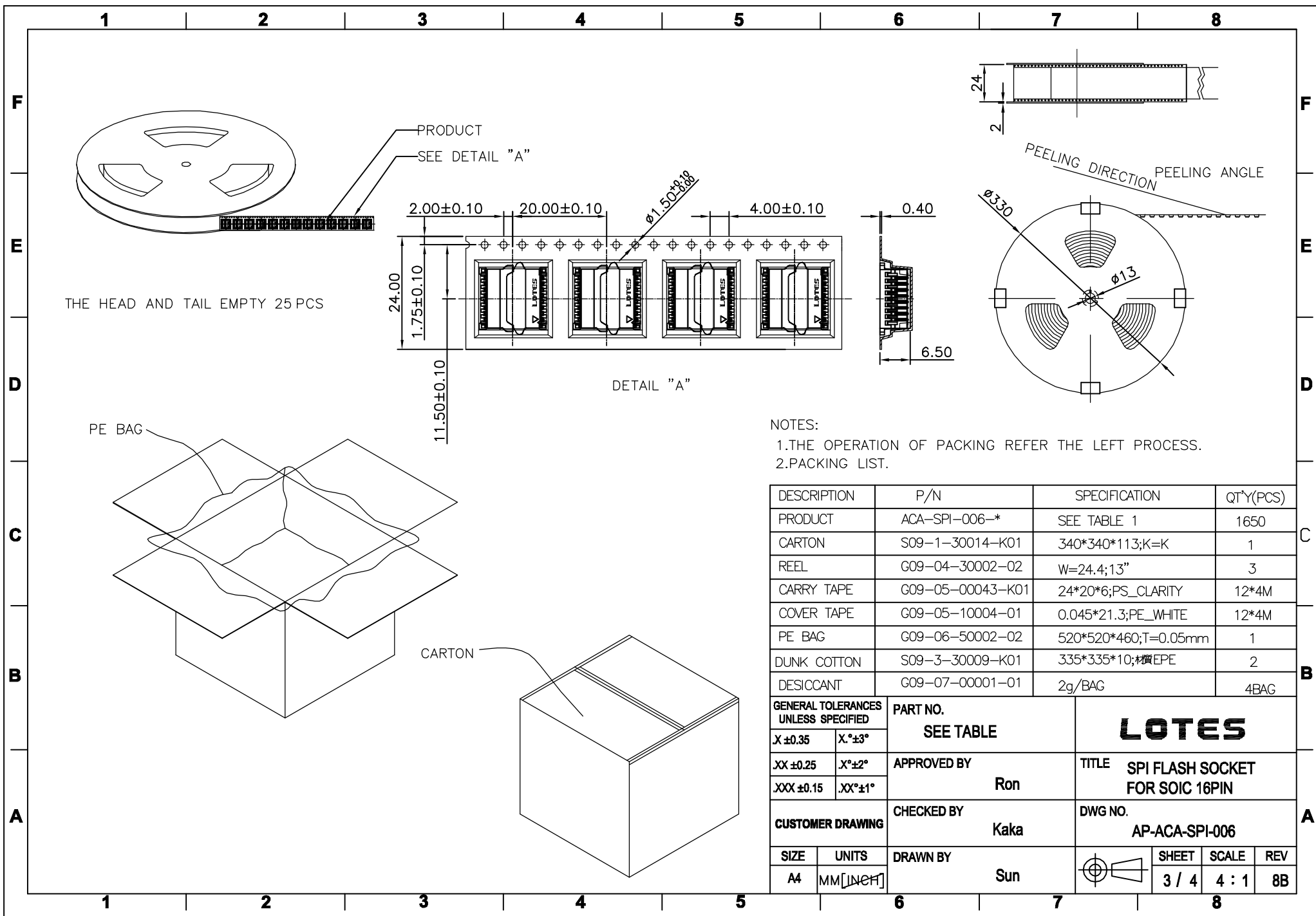

TABLE 1

NO.	PART NO.	DESCRIPTION
1	ACA-SPI-006-K01	Ni 50u" MIN, G/F 1 u" min
GENERAL TOLERANCES UNLESS SPECIFIED		LOTES
X ±0.35	X° ±3°	
XX ±0.25	X° ±2°	
XXX ±0.15	.XX° ±1°	
CUSTOMER DRAWING		DWG NO.
APPROVED BY		Ron
CHECKED BY		
DRAWN BY		Kaka
TITLE		SPI FLASH SOCKET FOR SOIC 16PIN
DWG NO.		AP-ACA-SPI-006
SIZE	UNITS	
A4	MM [INCH]	
SHEET		1 / 4
SCALE		4 : 1
REV		8B



GENERAL TOLERANCES UNLESS SPECIFIED		PART NO. SEE TABLE	LOTES			
X ±0.35	X° ±3°					
XX ±0.25	X° ±2°	APPROVED BY Ron	TITLE SPI FLASH SOCKET FOR SOIC 16PIN			
XXX ±0.15	XX° ±1°	CHECKED BY Kaka	DWG NO. AP-ACA-SPI-006			
CUSTOMER DRAWING		DRAWN BY Sun		SHEET	SCALE	REV
SIZE A4	UNITS MM [INCH]			2 / 4	4 : 1	8B



DESCRIPTION	P/N	SPECIFICATION	QT*Y(PCS)
PRODUCT	ACA-SPI-006-*	SEE TABLE 1	1650
CARTON	S09-1-30014-K01	340*340*113;K=K	1
REEL	G09-04-30002-02	W=24.4;13"	3
CARRY TAPE	G09-05-00043-K01	24*20*6;PS_CLARITY	12*4M
COVER TAPE	G09-05-10004-01	0.045*21.3;PE_WHITE	12*4M
PE BAG	G09-06-50002-02	520*520*460;T=0.05mm	1
DUNK COTTON	S09-3-30009-K01	335*335*10;材质EPE	2
DESICCANT	G09-07-00001-01	2g/BAG	4BAG

GENERAL TOLERANCES UNLESS SPECIFIED		PART NO. SEE TABLE	LOTES			
X ±0.35	X° ±3°					
XX ±0.25	XX° ±2°					
XXX ±0.15	.XX° ±1°	APPROVED BY Ron	TITLE SPI FLASH SOCKET FOR SOIC 16PIN			
CUSTOMER DRAWING		CHECKED BY Kaka	DWG NO. AP-ACA-SPI-006			
SIZE A4	UNITS MM [INCH]	DRAWN BY Sun		SHEET 3 / 4	SCALE 4 : 1	REV 8B

1

2

3

4

5

6

7

8

F

F

E

E

D

D

PATR NUMBER	SPECIFICATION	STORAGE TEMPERATURE	STORAGE TEMPERATURE
ACA-SPI-006-K01	SPI FLASH SOCKET FOR SOIC 16PIN	15°C~35°C	HR 45%~75%

C

C

B

B

A

A

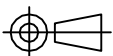
GENERAL TOLERANCES UNLESS SPECIFIED		PART NO. SEE TABLE	LOTES			
X ±0.35	X.°±3°					
.XX ±0.25	.X°±2°		APPROVED BY Ron	TITLE SPI FLASH SOCKET FOR SOIC 16PIN		
.XXX ±0.15	.XX°±1°	CHECKED BY Kaka	DWG NO. AP-ACA-SPI-006			
CUSTOMER DRAWING		DRAWN BY Sun		SHEET	SCALE	REV
SIZE A4	UNITS MM [INCH]			4 / 4	4 : 1	8B

1

2

3

4

5

6

7

8