

N-Channel High Density Trench MOSFET (30V, 85A)

PRODUCT SUMMARY

V_{DSS}	I_D	$R_{DS(on)}$ (m Ω) Typ.
30V	85	1.9 @ $V_{GS} = 10V, I_D = 20A$
		2.7 @ $V_{GS} = 4.5V, I_D = 20A$

Features

- Super high density cell design for extremely low RDS(ON)
- Low gate charge
- Exceptional on-resistance and maximum DC current capability
- Lead (Pb) -free and halogen-free

Applications

- DC/DC Converters in Computing, Servers, and POL
- Isolated DC/DC Converters in Telecom and Industrial

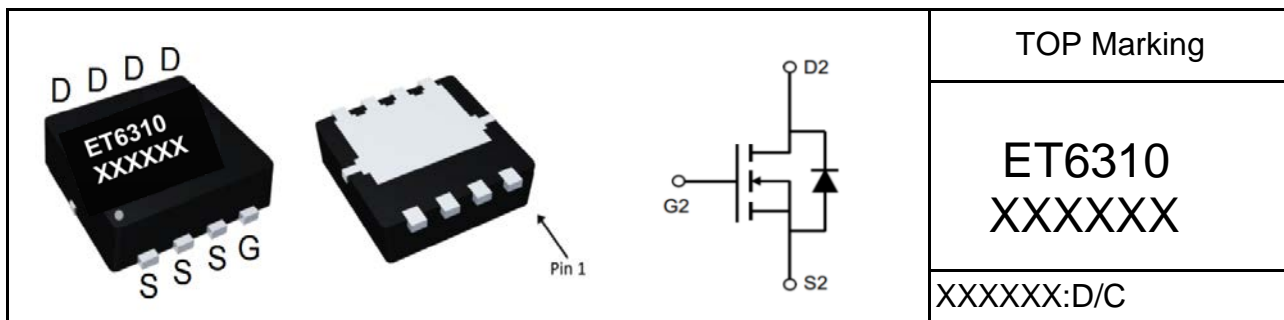

Absolute Maximum Ratings ($T_A = 25^\circ C$, unless otherwise noted)

Symbol	Parameter	Ratings	Units
V_{DS}	Drain-Source Voltage	30	V
V_{GS}	Gate-Source Voltage	± 20	V
I_D	Drain Current (Continuous) @ $T_A = 25^\circ C$	85	A
	Drain Current (Continuous) @ $T_A = 75^\circ C$	66	A
I_{DM}	Drain Current (Pulsed) ^a	300	A
P_D	Total Power Dissipation @ $T_A = 25^\circ C$	80	W
	Total Power Dissipation @ $T_A = 75^\circ C$	30	W
EAS	Avalanche energy, single pulsed ^b	50	mj
I_S	Maximum Diode Forward Current	85	A
T_j, T_{stg}	Operating Junction and Storage Temperature Range	-55 to +150	$^\circ C$
R_{QJA}	Thermal Resistance Junction to Ambient (PCB mounted) ^c	33	$^\circ C/W$

a: Repetitive Rating: Pulse width limited by the maximum junction temperature.

b: Limited by T_{jmax} , starting $T_J = 25^\circ C$, $L = 0.05mH, R_G = 25\Omega, I_{AS} = 85A, V_{GS} = 10V$. Part not recommended for use above this value

c: 1-in2 2oz Cu PCB board



Electrical Characteristics (T_A=25°C, unless otherwise noted)

Symbol	Characteristic	Test Conditions	Min.	Typ.	Max.	Unit
• Off Characteristics						
BV _{DSS}	Drain-Source Breakdown Voltage	V _{GS} =0V, I _D =250uA	30	-	-	V
I _{DSS}	Zero Gate Voltage Drain Current	V _{DS} =30V, V _{GS} =0V	-	-	1	μA
I _{GSS}	Gate-Body Leakage Current	V _{GS} =±20V, V _{DS} =0V	-	-	±100	nA
• On Characteristics						
V _{GS(th)}	Gate Threshold Voltage	V _{DS} =V _{GS} , I _D =250uA	1.0	1.7	2.4	V
R _{DS(on)}	Drain-Source On-State Resistance	V _{GS} =10V, I _D =20A	-	1.9	2.2	mΩ
		V _{GS} =4.5V, I _D =20A	-	2.7	3.0	
• Dynamic Characteristics						
C _{iss}	Input Capacitance	V _{DS} =15V, V _{GS} =0V, f=1MHz	-	3500	-	PF
C _{oss}	Output Capacitance		-	1320	-	
C _{rss}	Reverse Transfer Capacitance		-	182	-	
• Switching Characteristics						
Q _g	Total Gate Charge	V _{DS} =15V, I _D =20A, V _{GS} =10V	-	55	-	nC
Q _{gs}	Gate-Source Charge		-	8.2	-	
Q _{gd}	Gate-Drain Charge		-	12	-	
t _{d(on)}	Turn-on Delay Time	V _{DD} =15V, R _L =15Ω, I _D =1A, V _{GEN} =10V, R _G =6Ω	-	7.6	-	nS
t _r	Turn-on Rise Time		-	5.2	-	
t _{d(off)}	Turn-off Delay Time		-	34	-	
t _f	Turn-off Fall Time		-	10	-	
• Drain-Source Diode Characteristics						
V _{SD}	Drain-Source Diode Forward	V _{GS} =0V, I _S =20A	-	0.8	1.2	V

Note: Pulse Test: Pulse Width ≤ 300us, Duty Cycle ≤ 2%

Typical Characteristics Curves (Ta=25°C, unless otherwise note)

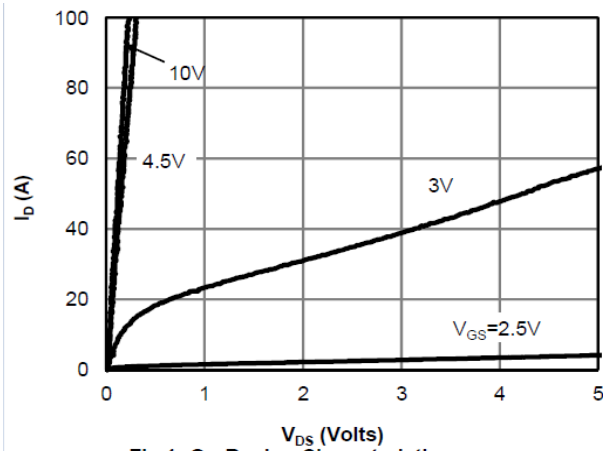

Fig 1: On-Region Characteristics

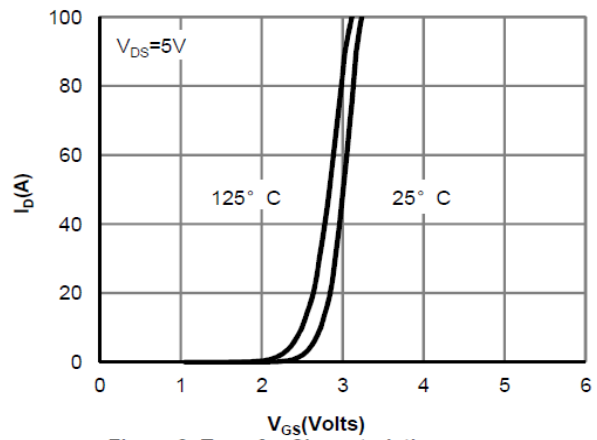

Figure 2: Transfer Characteristics

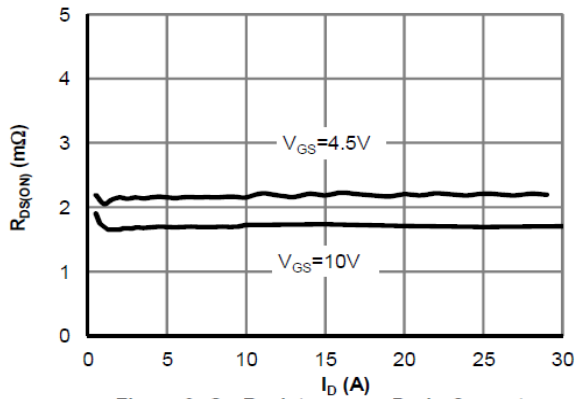

Figure 3: On-Resistance vs. Drain Current and Gate Voltage

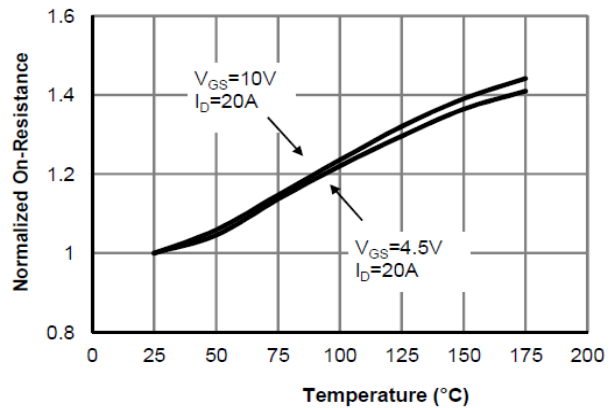

Figure 4: On-Resistance vs. Junction Temperature

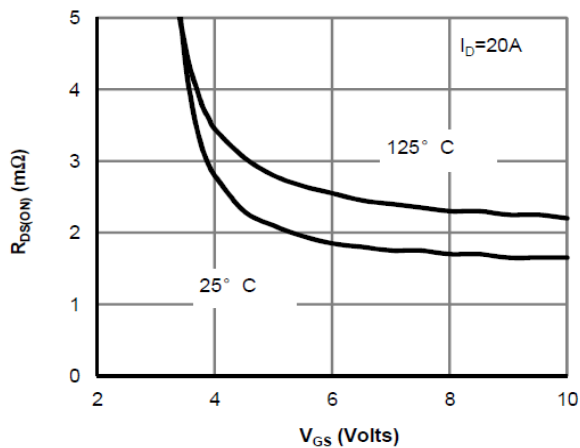

Figure 5: On-Resistance vs. Gate-Source Voltage

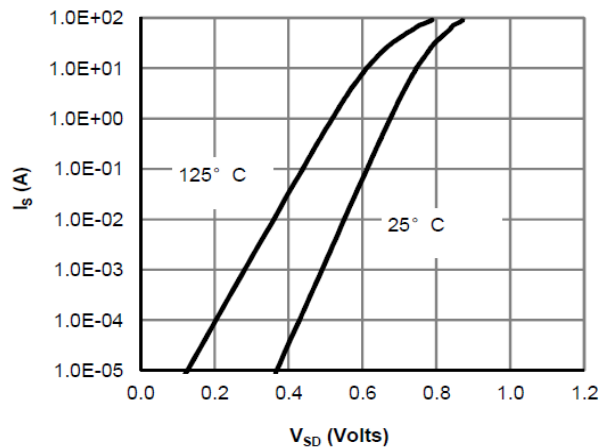

Figure 6: Body-Diode Characteristics

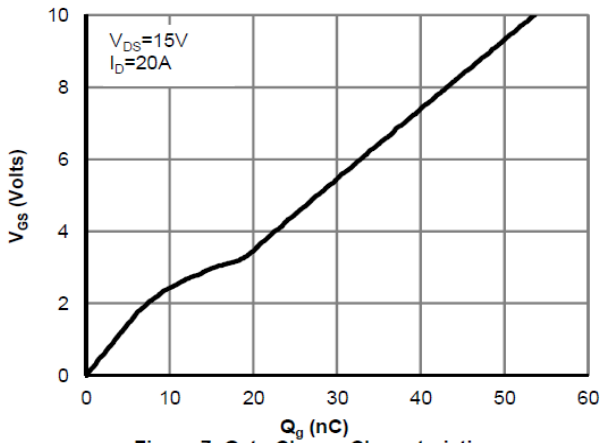

Figure 7: Gate-Charge Characteristics

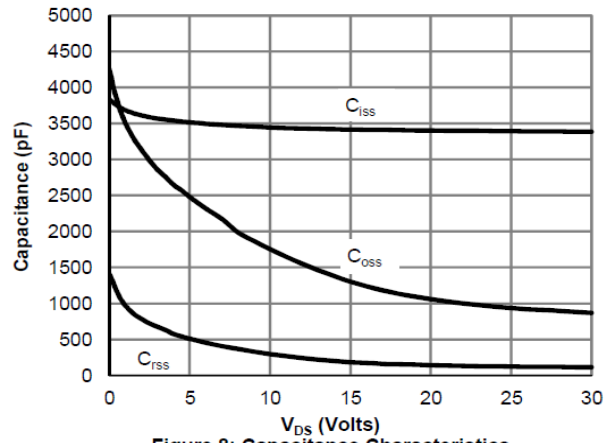

Figure 8: Capacitance Characteristics

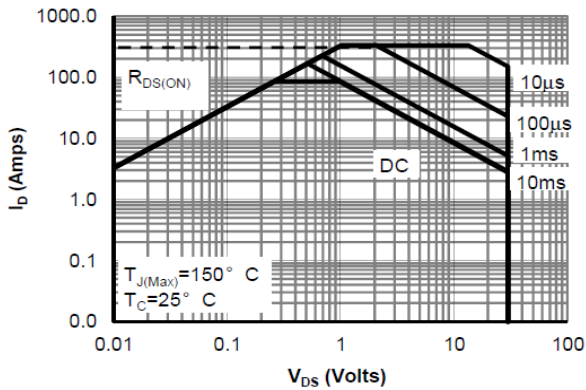

Figure 9: Maximum Forward Biased Safe Operating Area

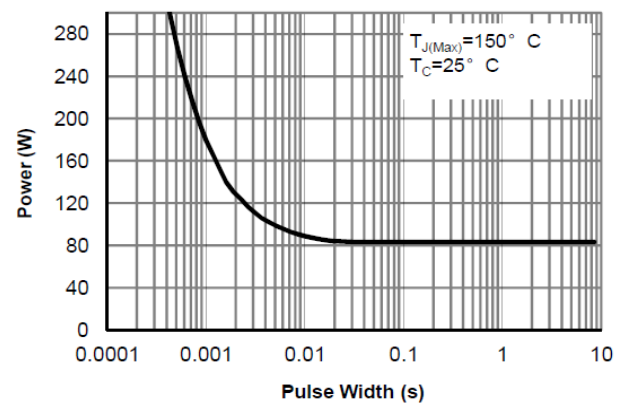

Figure 10: Single Pulse Power Rating Junction-to-Case

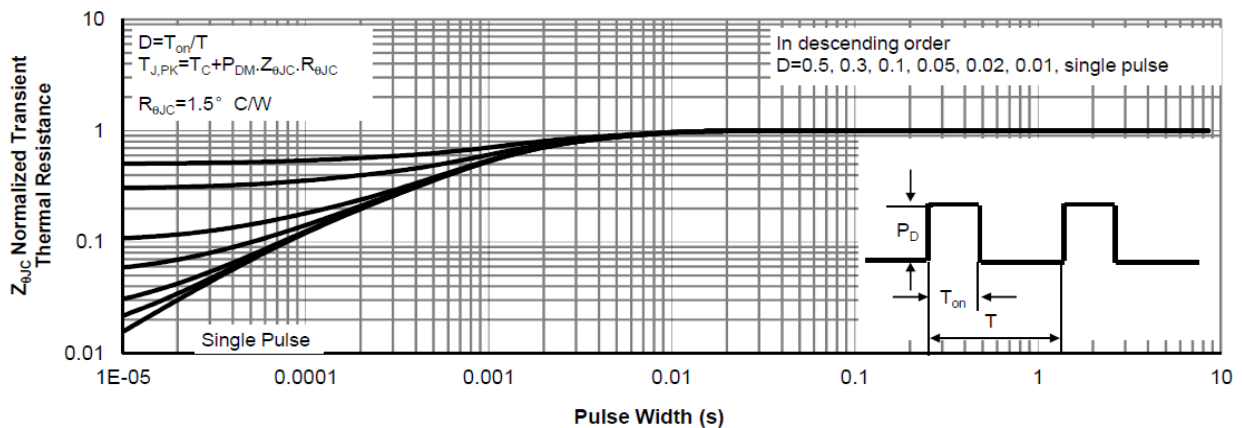
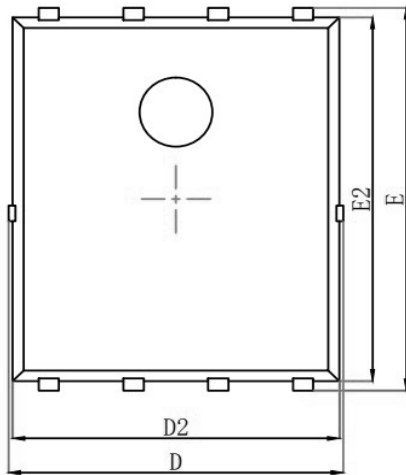
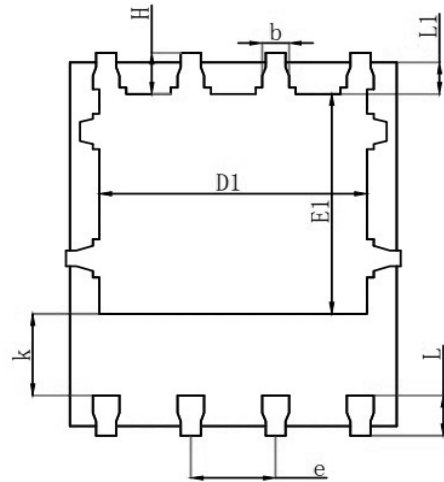

Figure 11: Normalized Maximum Transient Thermal Impedance

PDFN5*6 EP1 Package Outline Data



Top View



Bottom View

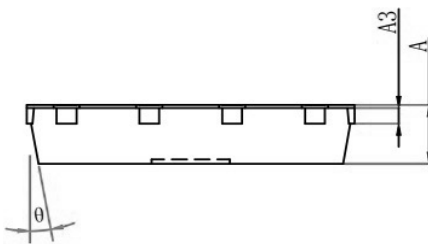

Side View

Symbol	Dimensions (unit : mm)		
	Min	TYP	Max
A	0.90		1.0
A3	0.254REF		
D	4.94	5.00	5.1
E	5.97	6.00	6.1
D1	3.91	4.00	4.1
E1	3.37	3.50	3.6
D2	4.82	4.90	5
E2	5.67	5.70	5.8
k	1.19	1.30	1.4
b	0.35	0.35	0.45
e	1.27TYP		
L	0.56	0.65	0.71
L1	0.52	0.55	0.58
H	0.57	0.60	0.73
θ	10 ⁰	11 ⁰	12 ⁰